

CLASSIC

Limites d'extensibilité

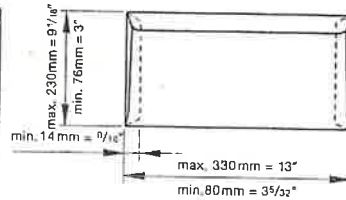

Limites de ajusté

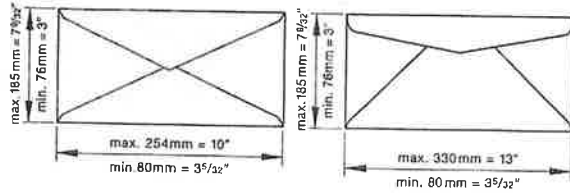
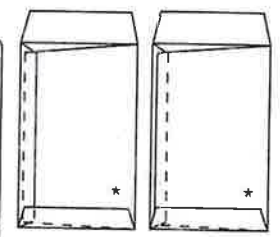
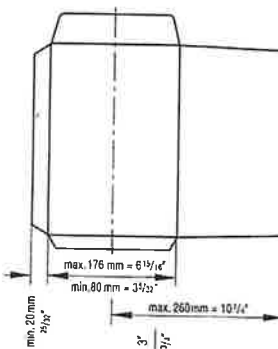
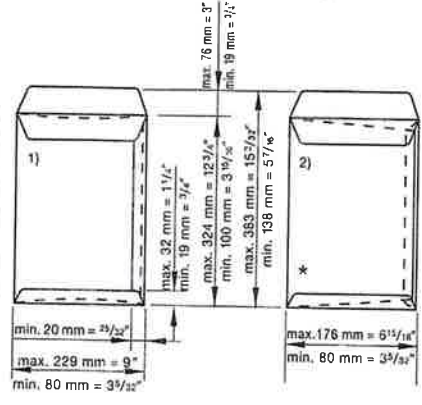
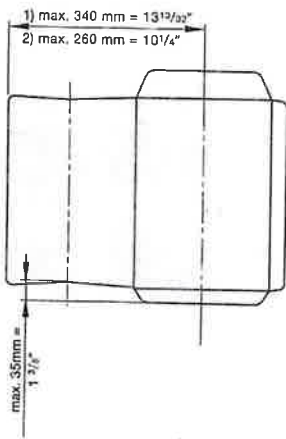
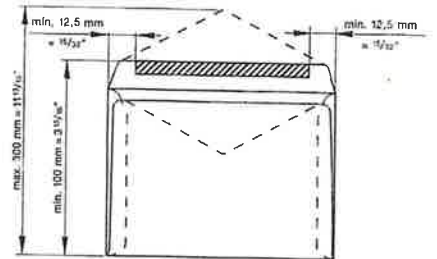
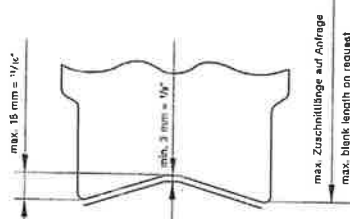
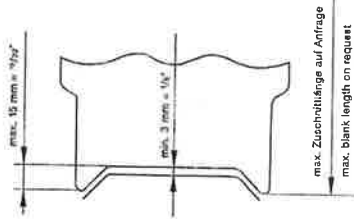
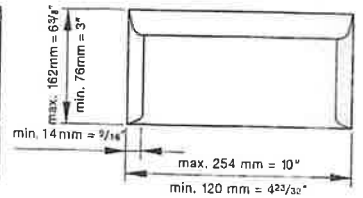

* seulement possible avec des outils de format spéciaux

* solamente realizable con herramientas de plegado especiales

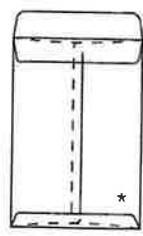
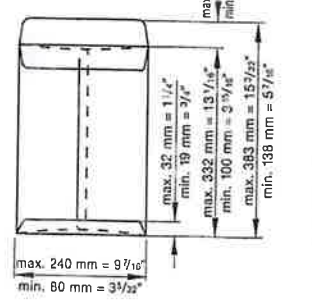
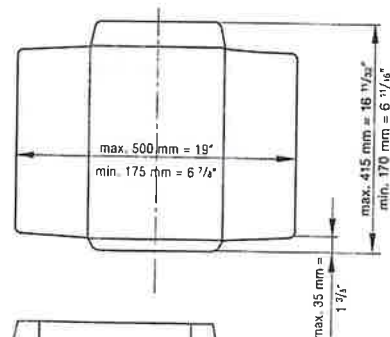

Zone de découpage Zona de corte

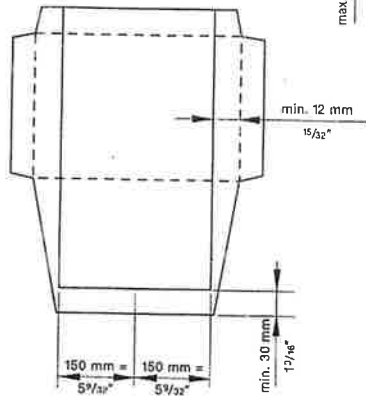

Zone d'encollage

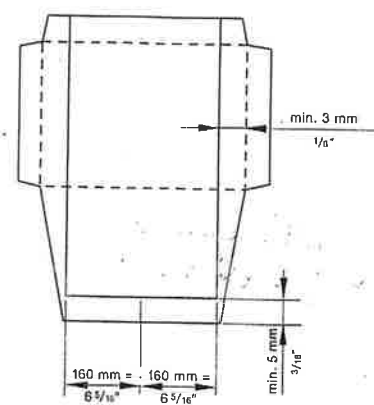

Nous vous prions de bien vouloir nous faire parvenir des échantillons des produits que vous souhaitez fabriquer sur cette machine car les limites d'extensibilité mentionnées se réfèrent aux formats standard et ne montrent pas toutes les possibilités.

Les rogamos nos envíen muestras de los productos que quisieran fabricar en esta máquina, ya que los mencionados límites de ajusté se refieren a formatos standard y no muestran todas las posibilidades.

CLASSIC

Verstellbarkelten

Size ranges

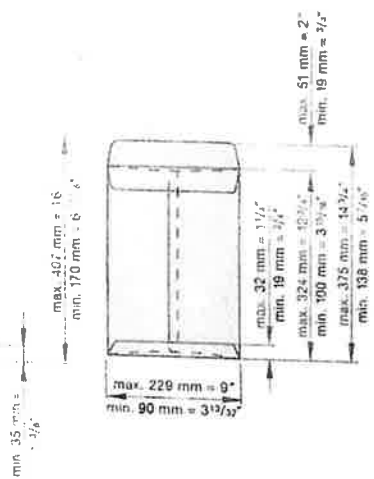
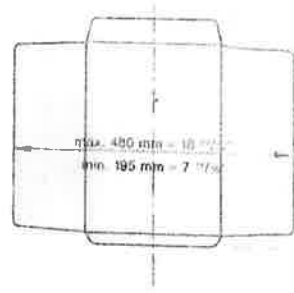
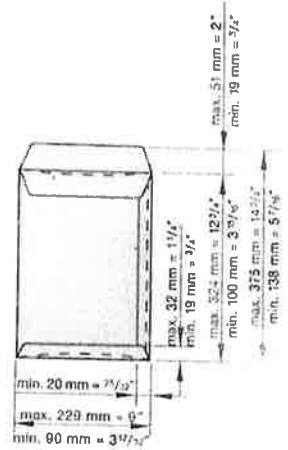
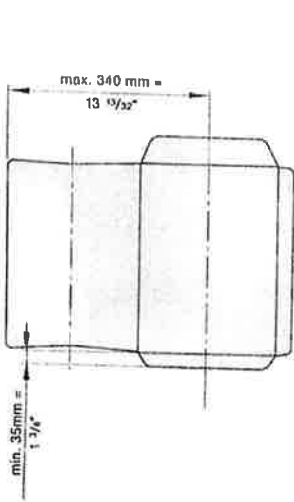
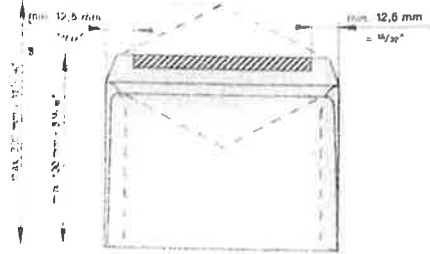
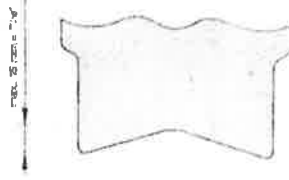
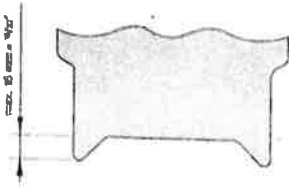
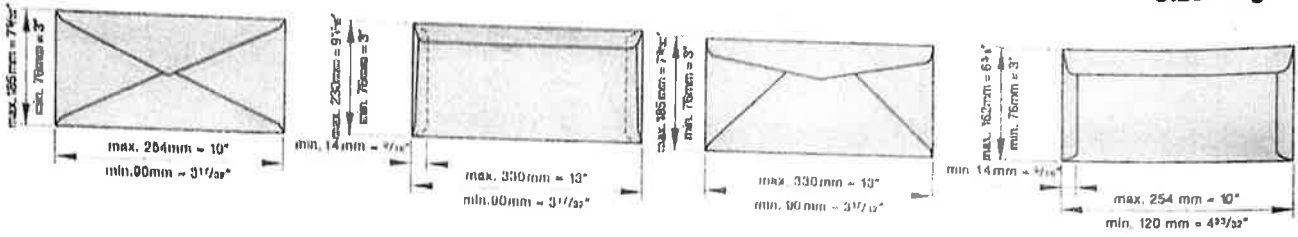

Ausschneidebereich Cutting area

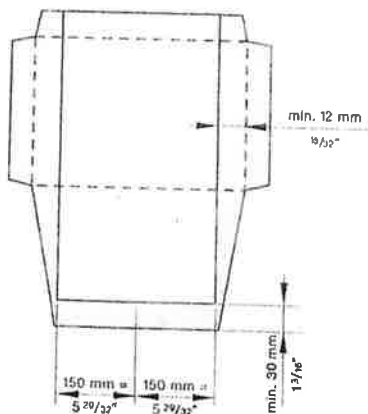

Einklebebereich Patching area

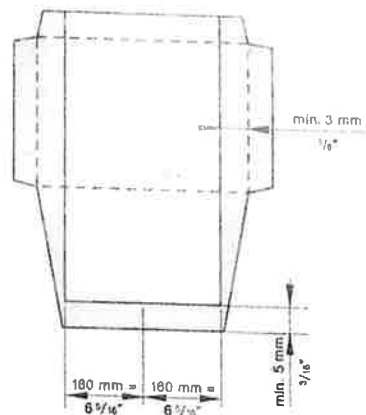

Bitte schicken Sie uns Muster der Produkte, die Sie auf dieser Maschine fertigen möchten, da die angegebenen Verstellbarkeitsgrenzen sich auf Standardformate beziehen und nicht alle Möglichkeiten aufzeigen.

Please send us samples of the products you intend to manufacture on this machine because the size ranges indicated refer to standard sizes and do not show all possibilities.