



Product Catalog Vertical Grinders

1000 SERIES

VERTICAL GRINDING MACHINES

The CGC Model 1000 is the core of Campbell Grinder Company's modular machine philosophy. High performance, reliability, and versatility find a perfect balance in the traveling column configuration. This allows Campbell Grinder Company to configure a machine specifically to a customer's requirements without compromising cost and lead time.

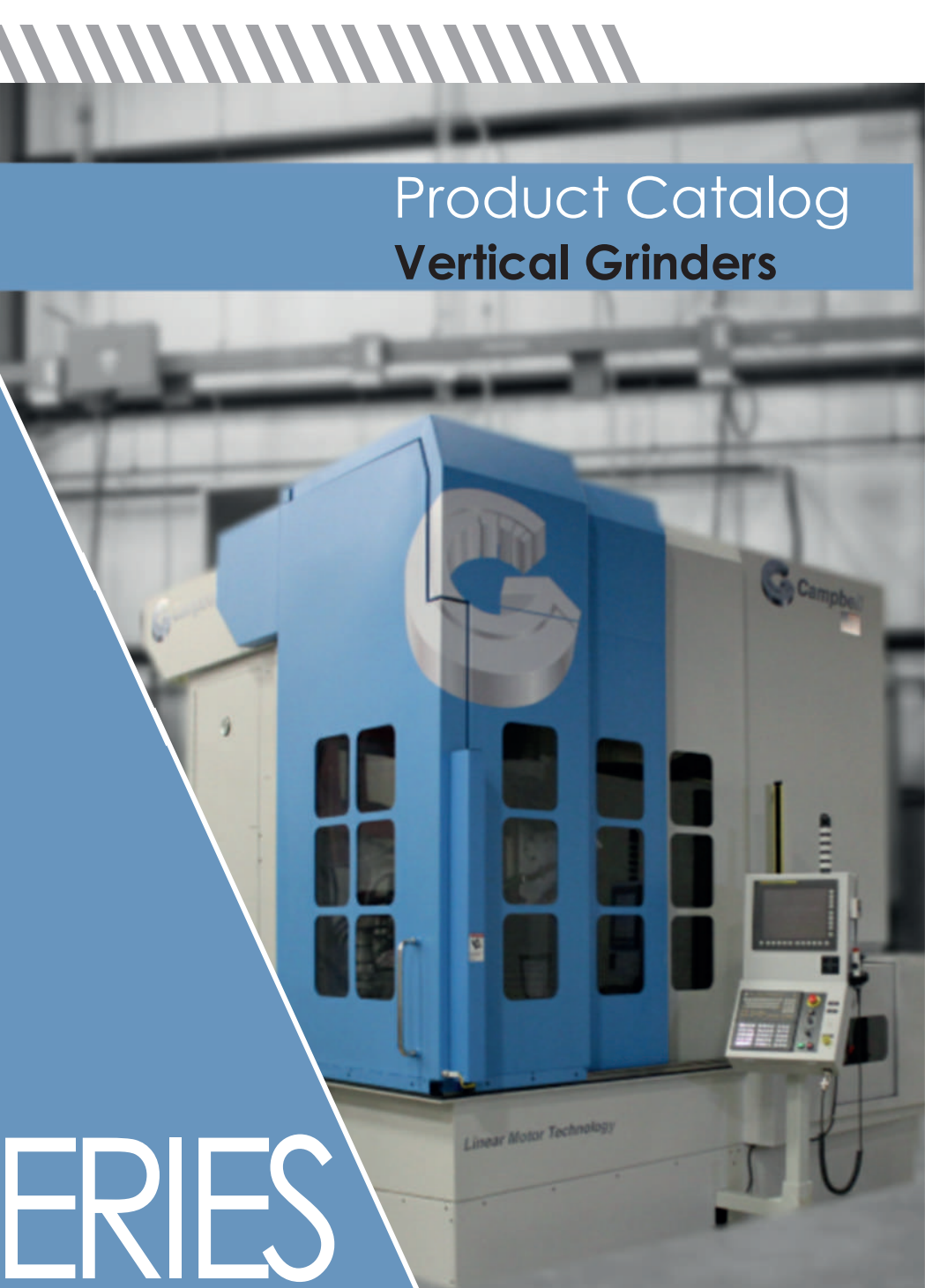

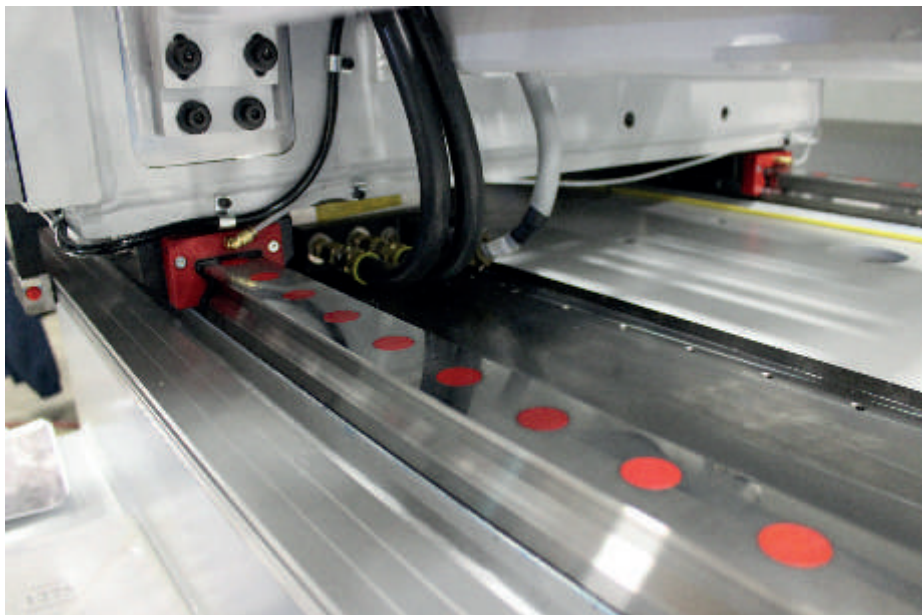

Linear Axes

The horizontal X axis of the Model 1000 acts as the machine "bed". The FEA optimized heavy box structure is a single-piece stress-relieved steel weldment. The 45mm roller guideway rails are mounted to surfaces that are directly ground and further hand-scraped into the weldment. This design allows for maximum mechanical precision before any electronic compensation, and is standard on all CGC linear axes. Also standard on all CGC linear axes is direct feedback through absolute linear encoders. The

advantages in controllability. True .00001in incremental motion can be achieved through the combination of linear motors and roller bearing guideways. Also, actual linear force can be accurately measured through the drive, allowing for grinding process optimization, as well as crash protection. Cycle times can be dramatically decreased with the higher feed rates allowed by the linear motors. Hydraulic fail-safe linear brakes come standard on all CGC linear motor axes, holding the axis in position during power-off and E-stop, and

perform extremely well on critical surface finish requirements and high stock removal rates.

Rotary Axes

For maximum versatility, the spindle assembly is mounted on a B axis turret. Along with angular positioning and simultaneous axis motion, the turret allows for options such as multiple spindles, part measuring systems, turning bars, etc. to be easily adapted. The dual servo drive design completely eliminates lost motion in the worm drive throughout the life of the axis. A direct-mounted absolute rotary encoder is standard.

Many options are available for table tops, bearings, and drives, and these are generally specified based on customer requirements. Simple rotary motion, full CNC axis, and a large range of size, power, and speeds can be adapted, as well as thru-table coolant, fixture hydraulics and pneumatics, etc. Table bearings are also generally specified based on customer requirements, and are almost always liquid cooled for precise thermal control.

"This design allows for maximum mechanical precision before any electronic compensation, and is standard on all CGC linear axes."

vertical Z column and slide structures are further optimized for high stiffness and lower mass. As moving components, their dynamics are critical to accurate, repeatable motion. The vertical Z axis' linear motor drive is assisted with a pneumatic counter balance system.

Motion is controlled using the latest linear motor technology. Zero-contact components guarantee reliability; ballscrew replacement is a thing of the past. Without the mechanical connections between the servo motor and axis, the liquid cooled linear motors also offer

decreasing stopping distance during E-stop conditions without harming components.

The entire machine is further optimized for maximum dynamic stiffness. Along with static stiffness, the dynamic stiffness of a machine structure is critical to grinding performance. Full FEA modal analysis, backed by experimental data has concluded that the Model 1000 design is very well-damped, and typically has a dynamic stiffness many times greater than the required cutting stiffness of the material and process. It is no wonder then, that model 1000s

Enclosure

The entire grind zone on all Model 1000s is completely enclosed and sealed from leaks. Door seals are 100% labyrinths, eliminating the requirement for rubber seals that quickly break apart. Doors allow full overhead access to the table to allow parts to be crane-loaded. LED lighting creates a no-maintenance, well-lit environment. Extremely durable Kevlar bellows allow for axis motion. All internal and external surfaces are powder-coated. Various options for mist-collection are available as well.

All machine doors are equipped with interlock safety systems. The complete enclosure is designed to safely contain debris from accidental wheel failures.

Grinding Spindle

Spindles come in a variety of specifications to meet customer needs. Available spindles range in power from 5 to 100 hp, speeds from 1 to 90,000 rpm, and can be equipped with various tool interfaces, direct drives, belt drives, automatic drawbars, etc. Standard features include ceramic hybrid ball bearings and liquid cooling. Multiple spindle arrangements are common as well, particularly for processes that require high and low speeds, and/or a long-nose I.D. spindle and an O.D. spindle. Belt drives offer the advantage of optimizing the motor's power curve to the grinding wheel periphery speeds. Spindle nose changing is also common for various I.D. grinding applications.

Wheel Dressing

Wheel dressing is one of the most critical features of a grinding machine. Accuracy of the dressed wheel form is the first step in producing an accurate ground surface. Also, forces in dressing often exceed the grinding forces. To meet these requirements, CGC offers several dressing systems. Each system is engineered to meet the critical requirements of the dressing process. The standard dressing

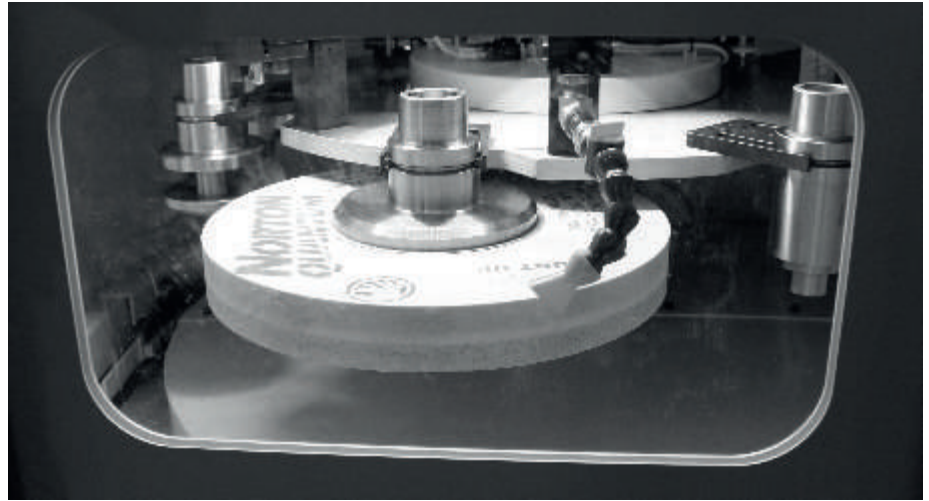

unit on a Model 1000 is a rotary dressing spindle. For even wider profiles and multiple dress rolls we can offer a variety of dual supported dresser spindles. Single point, cluster diamonds, etc. are also often added depending on customer requirements.

Continuous Dress Creep Feed

For maximum accuracy and stock removal in tough materials, the Continuous Dress Creep Feed process is a state-of-the-art option. The CDCF option adds a linear axis behind the spindle to feed the dress roll in-sync with the grinding wheel infeed during grinding. This keeps the grinding wheel at peak profile accuracy and sharpness. In many cases, stock removal rates are almost double a standard creep feed process. Typically this option adds grinding wheel and dress roll high-pressure scrubbing, along with provisions to accurately match coolant velocity with wheel periphery speeds.

Tool Changer

For added productivity, automatic tool changing is offered in several varieties based on customer requirements. For a limited number of tools (8 or less) a simple indexer style tool changer allows for quick and easy changes. For a larger number of tools, more varieties are available. Automatic coolant nozzle changing is also optional.

Fixture exchanger

For maximum machine-usage efficiency, an automatic fixture exchanger allows the operator to load and offload parts onto a fixture outside the machine, while the machine is in-process.

Part Probing

Several options for part probing are available, including skip-signal, strain-gauge, optical touch probes, optical linear probes, LVDT's, and displacement lasers. These can be mounted to fixed locations on the B axis turret, or in some cases radio-frequency units can be located in the tool changer.

Tool Probing

The beam-break style laser tool probe is a proven accurate and reliable method of measuring wheel size and shape on many Campbell Grinders. This tool can improve dressing times by eliminating the need to "dress air" in cases of unknown wheel diameter. It can also help with process development through a clearer understanding of wheel wear. Tool probing can also avoid crashes and over-speed conditions which can damage the machine.

Gap Elimination

For reduced cycle time, electronic gap elimination senses contact between the grinding wheel and dressing roll allowing a faster infeed up to the point of contact.

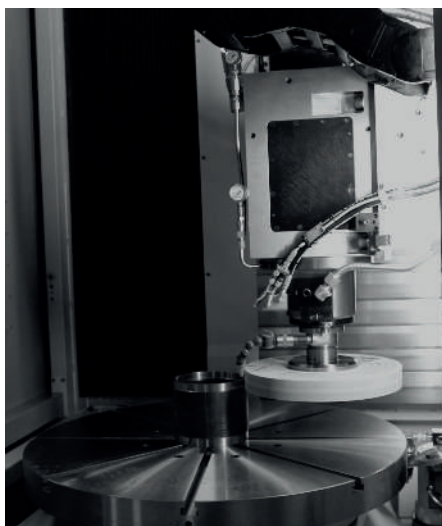



SPECIFICATIONS

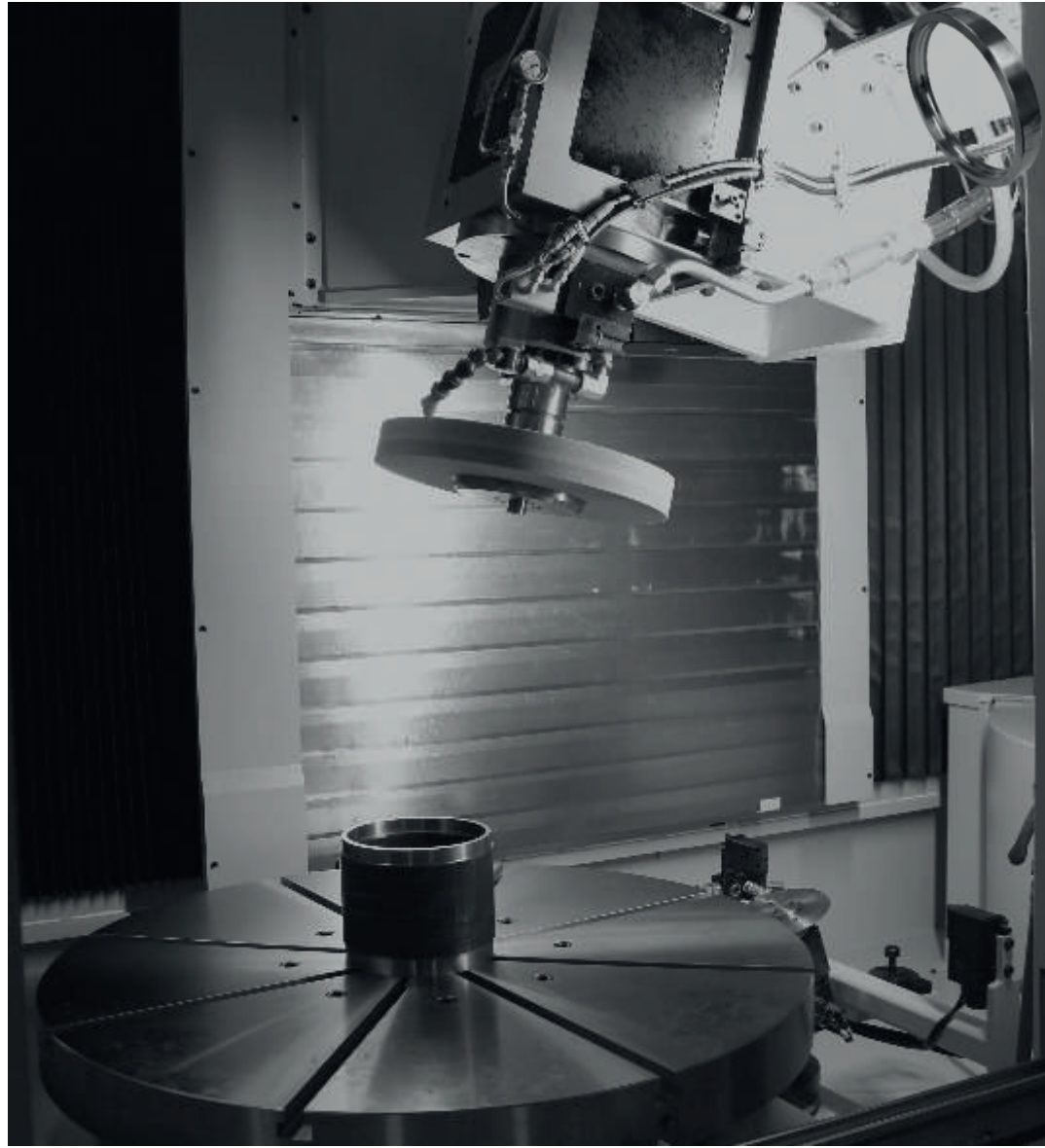

Version	1000C500	1000C1000	1000C1500	1000C2000
Control	Up to 4 axis simultaneous contouring - Fanuc 32i			
Dimensions	2.13 M x 3.00 M	2.8 M x 3.66 M	3.6 M x 3.66 M	3.8 M x 4.1 M
Swing Diameter	600 mm	1143 mm	1651 mm	2159 mm
Part Height	500 mm	1016 mm	1016 mm	1524 mm
Axes	X,Z,B,C	X,Z,B,C	X,Z,B,C	X,Z,B,C
Spindle	up to 25 HP	up to 40 HP	up to 60 HP	up to 60 HP

Z Axis: Accuracy: 5 Microns (0.0002")

X Axis Accuracy: 5 Microns (0.0002")

C Axis (Table Spindle): Run out 2.5 Microns (0.0001") both radial and axial, measured 305 mm (12") above the table top CL

(Optional) B Axis Spindle Swivel: Run out 5 Microns (0.0002") radial and axial, measured 305 mm (12") above the table top CL, Accuracy 10 arc seconds



FEATURES

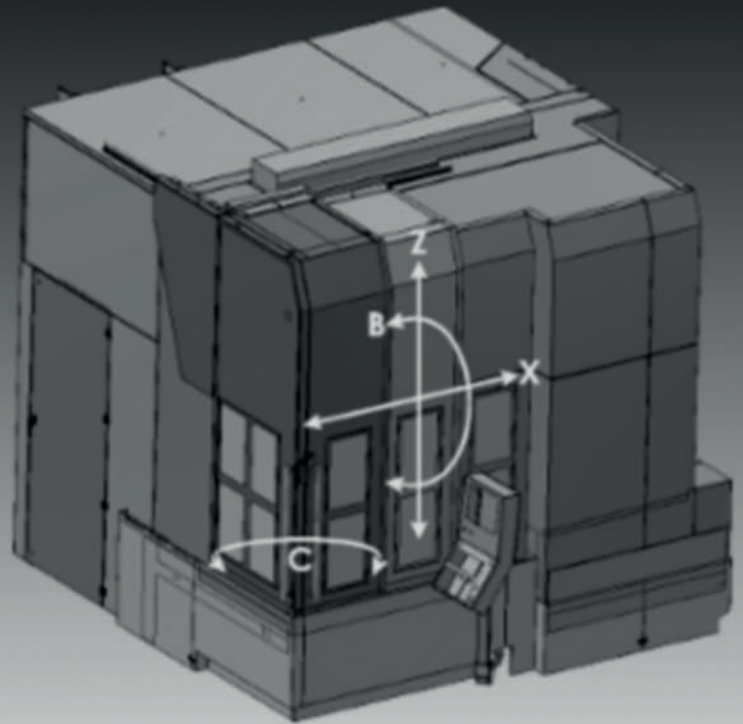

STANDARD

FANUC CNC Control Panel
Precision Roller Ways - All Axes
Ability To Use Any Abrasive

OD/ID Grinding Spindle
Single Point Dresser
Roller Style Table Bearing

Linear Glass Scales - All Axes
Full Machine Enclosure

OPTIONS

B-axis (spindle swivel)
Tool and nozzle changer
C-axis contouring rotary work table
High speed C-axis (rotary table)
CNC Radius dresser for bearing grinding
Magnetic chuck
Hydrostatic table bearing
Wireless part probe
Laser part measuring
Multiple grinding spindles on the same head

Turning
Steadyrest / Live center
Automatic shoes
Spindle indexer
Air knife
Dresser changer
Wheel load assist
Deburring spindle
Numerous spindle and power RPM combinations
Dust collector
Raised operator platform
Disk dresser

Roll form dresser
Wheel balance system
Tool probe
Milling and drilling
Gap eliminator
Spindle mounted dresser with optional dress roll changer
Mist collector
Coolant through the tool
Fire suppression system (for oil coolant)
Siemens 840D control

Product Catalog

Campbell Grinder Company

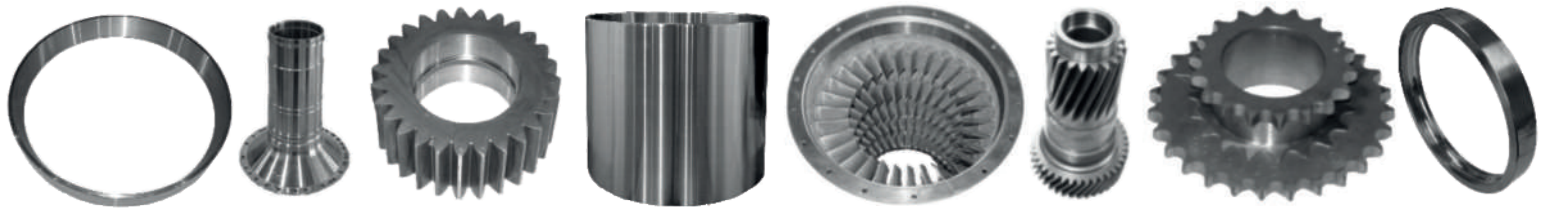

 **Campbell**

1226 E Pontaluna Rd
Spring Lake, MI 49456
(231) 798-6464

CampbellGrinder.com
cgc.sales@campbellgrinder.com