



**VHX**  
DIGITAL MICROSCOPE

A single unit of the VHX-500 provides all functions,  
from “zoom observation” to advanced analyses.

Digital Microscope

# “Clear” and “3-D” observation that is not available with conventional microscopes

All functions for “Observation”, “Recording” and “Measurement”, from observation to 3-D display, are condensed in the VHX-500 unit.

“Anyone who wishes to observe a target more easily, clearly and accurately in a shorter time”

The VHX-500 has been renewed to meet such a request.

The VHX-500 not only provides advanced functions that enable ultra-deep and high-definition observation, but it also can be operated easily by anyone.

The VHX-500 meets a variety of users’ requests for evaluation time reduction and quality improvement, from observation to analyzing steps.



**NEW** Digital Microscope VHX-500

---

## Ease of operation superior to conventional microscopes .....P4-5

- || Observation — Large depth of field
- || Recording — Recording observed images on the spot
- || Measurement — Enabling real-time measurement



---

## 1 Clear observation .....P6-8

- || 18,000,000-pixel handheld camera with the highest resolution in its class
- || High-resolution RZ lens
- || Contrast optimization (First in the industry)

---

## 2 3-D observation .....P9-11

- || Highest speed in the industry Real-time depth composition
- || Highest speed in the industry Quick 3-D function (Hybrid D.F.D method)
- || Various 3-D display and 3-D measurement modes

---

## 3 Easy operation .....P12

- || Optimal observation with the push of a button

---

## 4 More accurate measurement ...P13-15

- || Wide-visual-field, automatic 2-point distance measurement (Industry-first)
  - || 3-D profile automatic measurement
- 



# Ease of operation superior to conventional microscopes

The VHX-500 provides ease of operation superior to conventional microscopes, in any of the steps of “Observation”, “Recording” and “Measurement”.

Anyone can observe targets easily and accurately.

## “Observation”

### Clear 3-D observation with a large depth of field

The VHX-500 provides a depth of field at least 20 times larger than optical microscopes. Thus, the VHX-500 can accurately observe a target (even with a large height difference) that could not be focused on with conventional microscopes. Furthermore, the number of steps required for observation including focus adjustment can be reduced considerably.



Image captured with an optical microscope



Image captured with a digital microscope

### Enabling observation at all angles

You can freely observe a target with the lens unit held by hand or mounted to the stand. You can capture any phenomenon exactly without any oversights by changing the observation angle. Furthermore, the time required for observation can be reduced considerably.



Hand-held observation

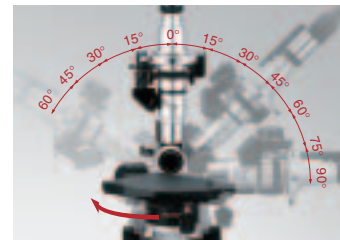

Free-angle observation system

### Enabling real-time image improvement

Through various digital processing functions, the VHX-500 can solve problems on displayed images caused by low contrast or darkness. With the KEYENCE-original graphic engine, the VHX-500 enables real-time observation while using the image improvement function, enabling accurate observation without overlooking any phenomenon.



Gold plating (100x)

Normal image



Improved image

## “Recording”

### Recording observed images on the spot

The VHX-500 incorporates a large-capacity (160 GB) HDD, enabling image files to be loaded easily into your PC via LAN. Furthermore, the VHX-500 can be connected to various storage media, enabling saved images to be loaded instantaneously into your storage media. Since the VHX-500 can save moving images as well as still images, it can record a real change or minute motion of a target over time.



## “Measurement”

### Enabling real-time measurement

Through simple mouse operations, the VHX-500 enables real-time measurement of the distance, radius, angle and area of a target on the monitor screen. Unlike the system that executes measurement after loading a still image into a PC, the VHX-500 can measure a target repeatedly while changing the visual field. This function is useful for measurement at various positions of a target.

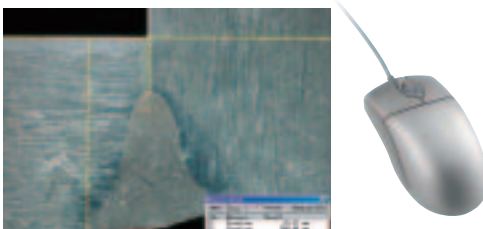

Weld penetration (50x)

## All In One

### All-in-one microscope incorporating “Observation”, “Recording” and “Measurement” functions

The VHX-500 provides a UXGA (1600 x 1200 pixels) high-resolution 15-inch LCD monitor, condensing all functions required for observation in the microscope unit. All functions for “Observation”, “Recording” and “Measurement” are available with a single unit of the VHX-500.

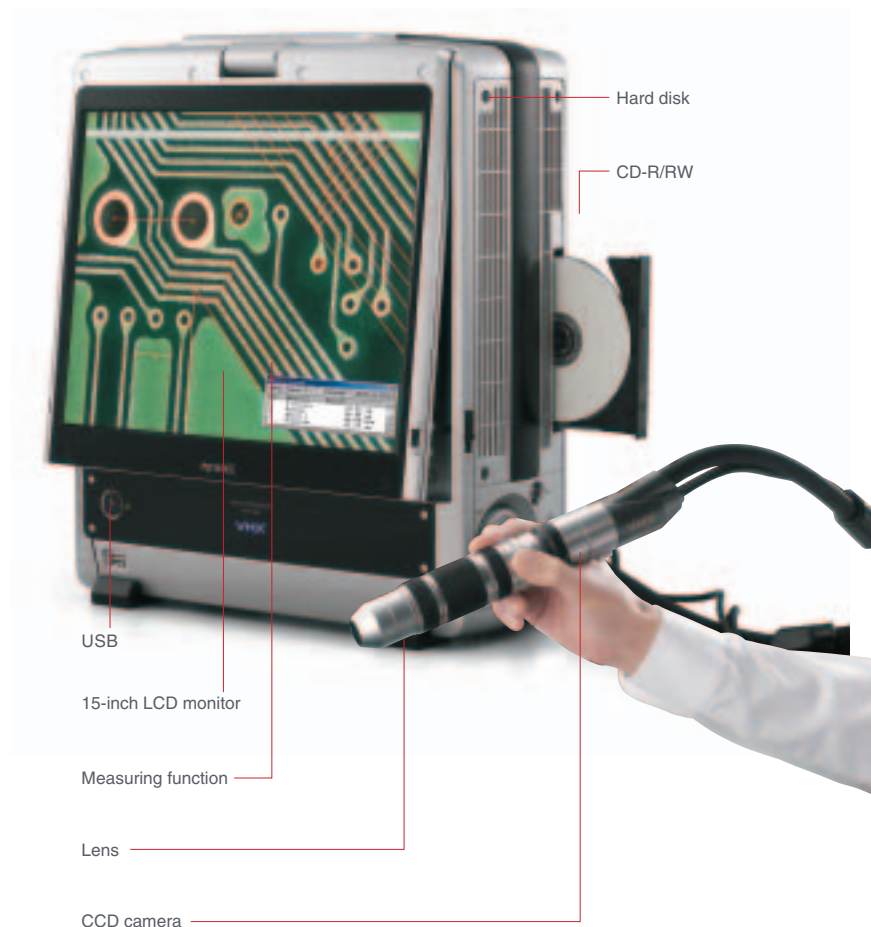





# 18 million pixels

Class-highest resolution

With a high-precision multi-scan system, the VHX-500 realizes the 18,000,000-pixel handheld camera of the highest class in the industry.

## 18,000,000-pixel handheld camera

Although the VHX-500 is compact, it enables high-definition (18 million pixels max.) observation by using the CCD multi-scan system with a built-in actuator. Furthermore, with the progressive scanning method that eliminates glare, the VHX-500 enables texture expression and color reproduction like observation with the naked eye.

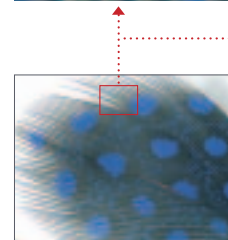
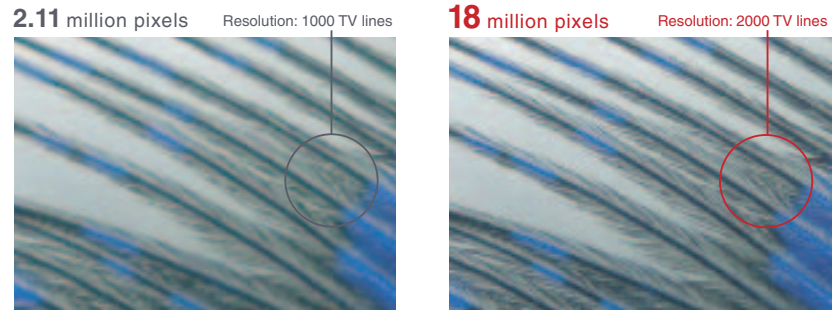

A peacock feather

- Selectable variations of resolutions suited for observation purposes
- 18,000,000-pixel ultra-high-definition mode (2000 TV lines)
  - 8,000,000-pixel high-definition mode (1600TV lines)
  - 2,000,000-pixel, 3-CCD mode (1200TV lines)
  - 4,000,000-pixel-equivalent clear mode [Equivalent to moving image] (1200TV lines)
  - 2,110,000-pixel normal mode (1000TV lines)

## Industry-first Camera-shake correcting function

Through further improvement of the processing capacity, the VHX-500 enables real-time camera-shake correction by sub pixel. This function enables high-magnification observation without being affected by environmental vibration.

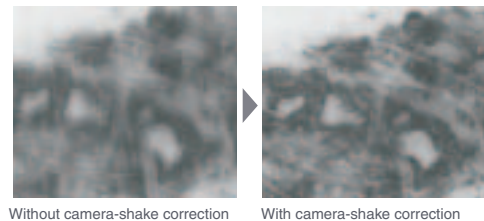

## Frame rate 15 F/sec

With a frame rate of 15 frames/second, the VHX-500 provides excellent tracking ability, enabling magnification change and focus adjustment to be performed smoothly.

# High-resolution lens

With KEYENCE-original optical technologies, the VHX-500 provides class-highest resolution, enabling clear and accurate observation.

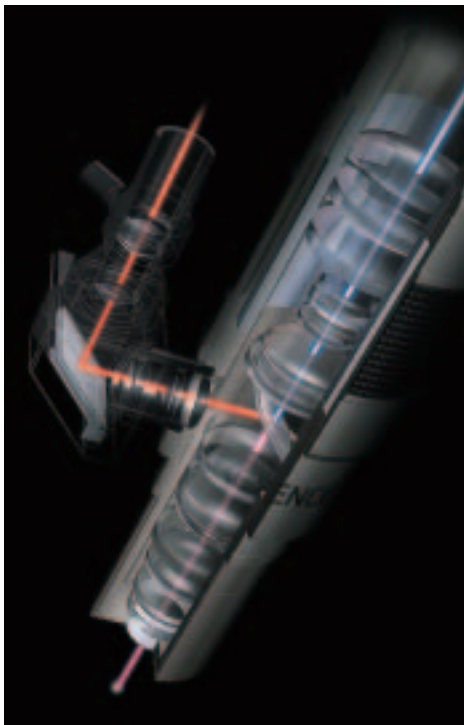

## RZ LENS

— Real Zoom Lens —

The VHX-500 uses the RZ (real zoom) lens, or the high-performance lens that can correct chromatic aberration to an ideal value. Through the leading-edge optical design and advanced illumination technology, the VHX-500 can minimize aberration distortion. Furthermore, with the highly-telecentric lens design, the RZ lens can create extremely clear and perfect-depth composition images and 3-D images. By making the best use of the digital focus functions that are the essential feature of the VHX Series, the high-performance RZ lens enables “real” observation as its name expresses.

The lens unit is comprised of 24 lenses in total, including 8 groups of 13 lenses for the objective section, and 9 groups of 11 lenses for the zoom section. Using a silica lens, the VHX-500 can correct chromatic aberration almost ideally.

NEW

VH-Z20

20 ▶ 200



### Ultra-small, high-performance zoom lens

- Class-highest resolution. Providing a resolution approximately twice as high as conventional microscopes
- A depth of field at least twenty times larger than optical microscopes
- Optical 10x zoom covering 20x to 200x observation magnification

VH-Z100

100 ▶ 1000



### Wide-range zoom lens

- High-resolution lens. Providing 2.5 times higher resolution than conventional microscopes
- Optical 10x zoom covering 100x to 1000x observation magnification at a 0.98" (25 mm) observation distance
- Extremely large depth of field: Approx. twice as deep as conventional microscopes

VH-Z500

500 ▶ 5000



### High-resolution zoom lens

- High-resolution lens with a numerical aperture (NA) of 0.82
- Optical 10x zoom covering 500x to 5000x observation magnification
- Enabling observation under polarizing illumination



# Optimal settings

With the KEYENCE-original graphic engine, you can always observe a target with optimal settings. The VHX-500 enables accurate observation without overlooking any phenomenon.

## Contrast

### Optimal contrast Industry-first

Real-time correction according to the sensitivity of human eyes

With the original algorithm, the VHX-500 automatically adjusts dark and bright areas to the optimal contrast, without changing the area with proper sensitivity. You can even observe fine texture which cannot be expressed only with illumination adjustment.

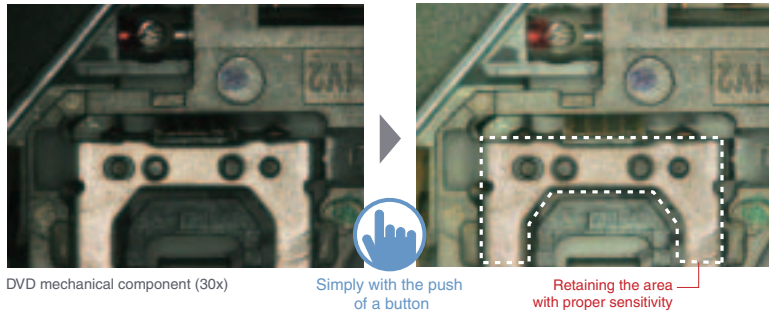

DVD mechanical component (30x)

Simply with the push of a button

Retaining the area with proper sensitivity

### Eliminating halation Industry-first

For a still image **Eliminating the glare of a target**

In addition to the contrast optimization, the KEYENCE-original halation eliminating function can suppress the glare of a target subjected to strong reflected light, enabling clear observation. This function can remarkably reduce the time required for illumination adjustment.

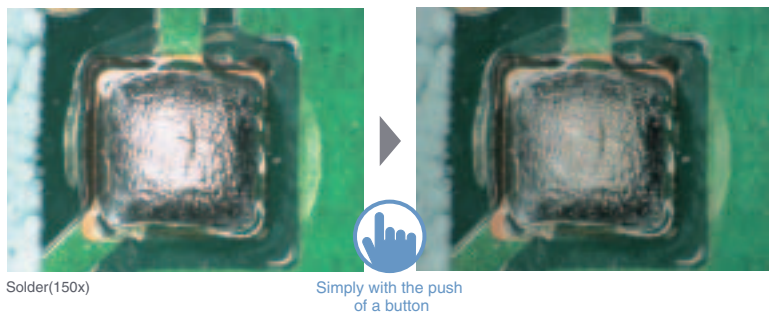

Solder(150x)

Simply with the push of a button

Image improvement function applicable to various targets	<b>Supercharge shutter</b> When the displayed image is dark due to insufficient light quantity, the shutter time can be specified in 0.1-second steps up to 17 seconds (max).	<b>Gamma correction</b> Provides contrast for a target without brightness difference.	<b>Edge enhancement function</b> Enhances the edges of an observation area, enabling easy detection of a minute flaw.	<b>Noise elimination</b> Eliminates noise components only, with original image data retained.
--	--	--	--	--

## Lighting

### Lighting shift function Industry-first



One-button control for enhancing projections and depressions Simply with the push of a button

Simply by pushing the "Height Difference Enhancement" button on the console, the illumination mode is switched instantaneously to bijective illumination that enhances target edges.

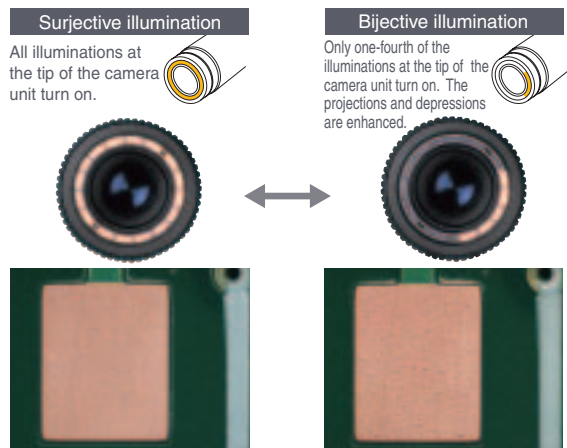

Gold plating(100x)

### e-Preview mode Industry-first



One-click operation selects the image mode optimal for observation. Simply with the push of a button

Simply by pushing the "Optimal Image" button, four types of image modes are listed. Then, you can click on an image suitable for your observation purpose.

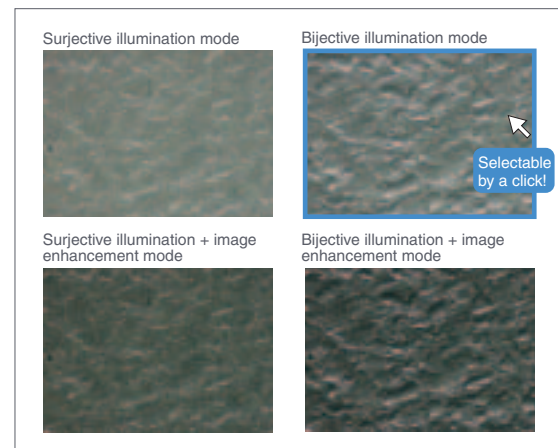

Coating surface condition (500x)



# Digital Focus

Even for a target with uneven surface conditions, the VHX-500 can remarkably reduce observation time by setting a focal distance to infinity.

## Real-time depth composition Highest speed in the industry

Effective for quick confirmation of the whole image (Approx. 5 times higher speed than conventional microscopes)

“Real-time depth composition” enables depth composition so quickly that you may not realize that you have executed composition. You can view the overall-in-focus image in real time simply by turning the focus adjusting dial while observing a target. With the KEYENCE-original graphic engine, the VHX-500 can quickly display a composed image on the large (UXGA) screen. Therefore, you can save a considerable amount of labor and time required for composition.



Observation at high magnification

The microscope cannot be focused on the whole image.



When a higher area is brought into focus



When a lower area is brought into focus

Observation using the VHX digital microscope

The whole image is brought into focus simply by moving the lens downward.



Coil (400x)

## High-quality depth composition Industry-first

Composing sharp images with superior depth-of-field while correcting the edge deviations

With the KEYENCE-original hybrid D.F.D depth composition method, the VHX-500 can display a high-definition, overall-in-focus image without being affected by extraneous light. Furthermore, the VHX-500 provides the “position correction” function as a standard feature, which can correct edge displacement of a target image and magnification fluctuations caused by shift of the focus position. The VHX-500 can create a “high-quality” composed image as its name expresses.

### Position correction

The VHX-500 corrects edge displacement caused by shift of the focus position of a non-telecentric optical lens.

When an image with different focus positions is captured with a non-telecentric optical lens, the edge of the target image will be displaced when the focus position is changed. The VHX-500 can correct such edge displacement automatically and display a highly perfect, overall-in-focus image.



Component on board (90x)  
Without position correction



With position correction

Originally developed graphic engine

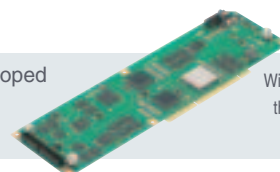

With the special image processing board based on the KEYENCE-original architecture, the VHX-500 enables real-time processing of UXGA images.



# Quick 3D

A 3-D image can be displayed instantaneously by moving the lens downward.

## Quick 3-D display Highest speed in the industry

### Ultimate ease of operation

Through speed-up of the hybrid D.F.D method, the VHX-500 enables you to create a "high-quality" composed image instantaneously by turning the focus adjusting knob and proceeding directly to the 3-D display mode.

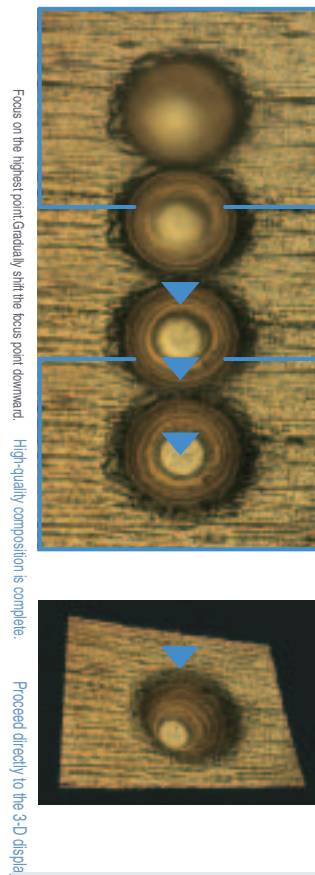

The "D.F.D" method is an abbreviation of the "Depth from Defocus" method, a method for obtaining 3-D depth data through analysis of defocus of 2-D images. Even if a completely focused image cannot be captured, the VHX-500 series calculates a height difference of the target. Thus, the VHX-500 series enables depth composition and 3-D image display by using less sample images than conventional microscopes. This method eliminates the need to load images on all focus positions, resulting in analysis efficiency improvement.

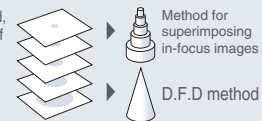

Furthermore, the hybrid D.F.D method provides the following features:

- Enables accurate composition even with a target that has a gentle slope and no remarkable unevenness. (A.D.I algorithm)
- Noise waveform generated on a target edge can be eliminated securely. (A.S.I filter)

## 3-D illumination simulation function

Since the illumination direction can be changed freely through mouse control, the VHX-500 series can capture optimal images according to the purpose of observation, such as observation of the profile and surface condition. This function is effective for observation of fine surface conditions.



Ceramic substrate (1000x)

Normal 3-D image

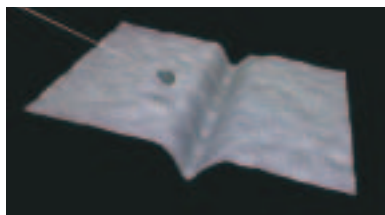

3-D illumination simulation image

## 3-D two-screen simultaneous comparative function

This function enables comparative observation with two different targets placed side by side, while changing the observation angle. Furthermore, the comparative difference display function has been newly added, which allows you to capture a profile difference visually with two types of 3-D data superimposed.

Two-screen simultaneous comparative function



Comparative difference display function



## Various measurements on the 3-D image New function \*Function of the VHX-H2M

### Volume measurement

A volume surrounded with the rectangle on a 3-D image can be measured.

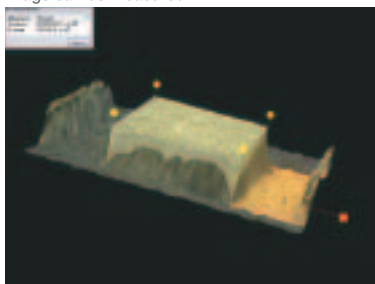

### Cross-section profile measurement<sup>3</sup>

An arbitrary cross-section profile on a 3-D image can be measured.

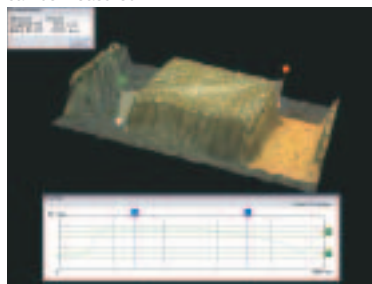

### Plane distance measurement

A distance between two parallel planes on a 3-D image can be measured.

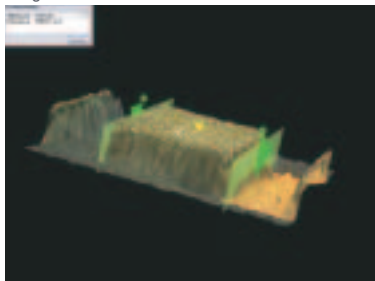

### Plane angle measurement

A cross-section angle of two arbitrary planes on a 3-D image can be measured.



3-D observation allows you to see such details



# Simple operation



## Optimal observation is enabled simply with the push of a button.

This console is intended to perform observation more quickly and easily. Only commonly used functions are provided on the console, enabling you to observe any target clearly with the push of a button.

### Optimal contrast

Adjusts the contrast automatically according to the sensitivity of human eyes.

### Height Difference Enhancement

The surjective and bijective illumination modes can be switched simply by pressing this button.

### REC

Recording

### PAUSE

Pause

### Remove Halation

Eliminates the glare of a target surface caused by light reflection.

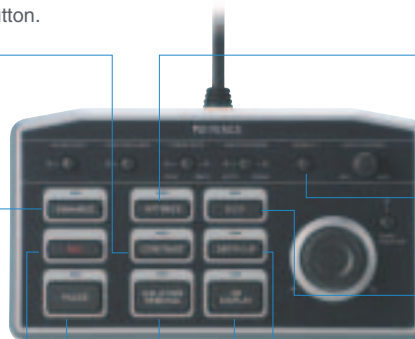

### Optimal Image

Four types of images modes are listed, allowing you to select a suitable image according to the purpose of observation.

### Real Digital Zoom

You can simultaneously zoom in on a desired observation spot.

### Camera-Shake Correction

Corrects minute vibration such as environmental vibration, ensuring stable observation.

### Real-time depth composition

Simultaneously composes images of a target with a height difference.

### Quick 3-D display

Creates a 3-D image simply by moving the focus downward.

## Useful observation functions

**Split function** Screen-split function that simplifies comparative observation

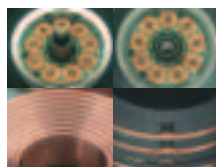

Motor

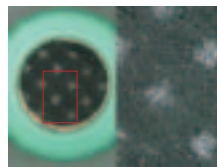

Vertical two-part split Electronic component



Horizontal two-part split Razor (2000x)

Four-part split

## Easy data recording/application

### Compatible with USB2.0



The VHX-500 can be connected to various storage media (external memory devices) via the USB interface. (USB2.0)

You can quickly take observation results by using your storage media.

\* Some devices may not be compatible, depending on the specifications.

### Compatible with LAN / FTP server



The VHX-500 provides a 1000baseT LAN port. You can take data from your PC browser or FTP software by setting a VHX IP address to use a FTP server.

\* For connection to a FTP server, additional software is required.

### VHX-500 communication software (Free software)

Dedicated software that can be used on your PC. This software enables data transmission/reception between the VHX and PC via LAN.

With the newly added high-speed transmission mode for LAN, data communication speed becomes three times higher than conventional models.

(Compatible OS: Windows XP / 2000)

### VHX-500 3-D display software (Free software)

This software reproduces a 3-D image captured with the VHX Series, allowing you to observe the 3-D image while changing the 3-D angle, as well as a still image. It is new report tool software that can convey analysis results correctly to associated people by giving impact on the visuals.



# Real-time measurement on screen

## High-resolution dimensional measurement function

Enables more accurate measurement on the 4800 x 3600 screen  
You can specify a measuring point on an image captured in a size 9 times larger than conventional microscopes through the multi-scan system, enabling more accurate dimensional measurement. Furthermore, to place importance on operability, the VHX-500 automatically restores the enlarged screen to the original size after measuring point setup is completed, allowing you to continue observation and image capturing.

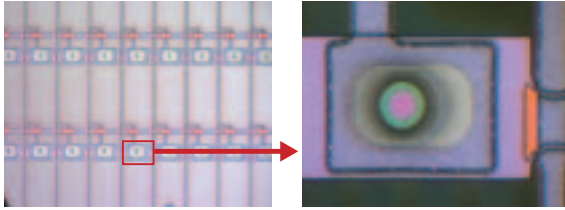

Normal screen      TFT (500x)      Enlarged screen

## Wide-visual-field, automatic 2-point distance measurement function Industry-first

Enables dimensional measurement by sub pixel  
The VHX-500 automatically finds a specified image from a low-magnification, wide-visual-field image through pattern matching. This function enables wide-range, high-precision, automatic 2-point distance measurement.

## Auto edge selection function Industry-first

Ensuring more accurate observation by eliminating personal errors

Even when the measurement point specified by clicking the mouse on the screen is deviated, the edge of the target is detected to correct the measurement point automatically. This function realizes accurate and highly reliable dimension measurement by eliminating the reading errors of operators.

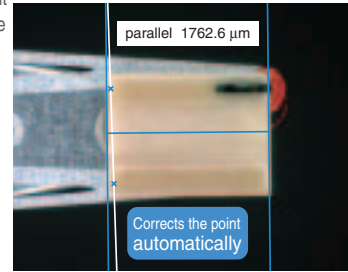

Read head of hard disk (70x)

## Auto calibration Industry-first

A special glass scale enables automatic calibration.

Automated calibration according to the observation magnification can be performed using the special glass scale (op-51483), enabling accurate dimension measurements without significant measurement errors.

### Various measurement modes

#### Distance

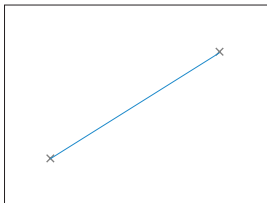

The distance between two points on the screen can be measured by specifying the points with the cursor.

#### Radius

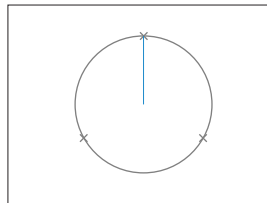

The radius of the circle can be measured by specifying the desired three points on the screen.

#### Center distance

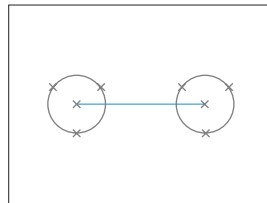

Specify three points on the circumference to find the coordinate of the circle center. The distance between two circle centers can be measured by specifying two circles sequentially.

#### X-Y distance

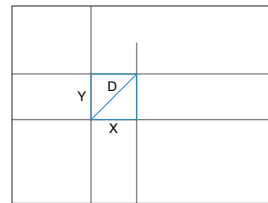

The longitudinal (X-direction), transversal (Y-direction), and diagonal (D-direction) distances of a rectangle formed by four coordinate axes (two in the X-direction and two in the Y-direction) can be measured at one time.

### Area/Count/Auto measurement



Connector crimp (100x)

The target of the measurement can be extracted automatically by differentiating the brightness and colors in the image. The area and the perimeter length are measured. The number of extracted areas can be counted automatically as well.

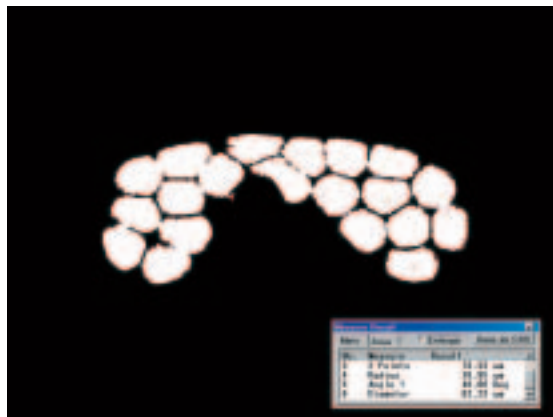

#### Distance between parallel lines

The shortest distance between two parallel lines can be measured by specifying two arbitrary points that draw a line and another line parallel to the first line.

#### Length of perpendicular line

The shortest distance (perpendicular line) between a line specified with two arbitrary points and another arbitrary point can be measured.

The angle determined by three arbitrary points on the screen can be measured.

#### Bar/Mesh/Cross

Bar, mesh, cross and other various shapes can be displayed as a scale. These can be conveniently used as the reference scale for simplified measurement or for printing the images.

# 3-D profile measurement using a microscope

With the high-precision electric linear stage and the newly-developed profile measurement function, the VHX-500 integrates all steps from zoom observation to 3-D profile automatic measurement. The VHX-500 enables further advanced analyses over zoom observation.

## Profile Measurement Unit

### 3-D profile automatic measurement unit

Optional

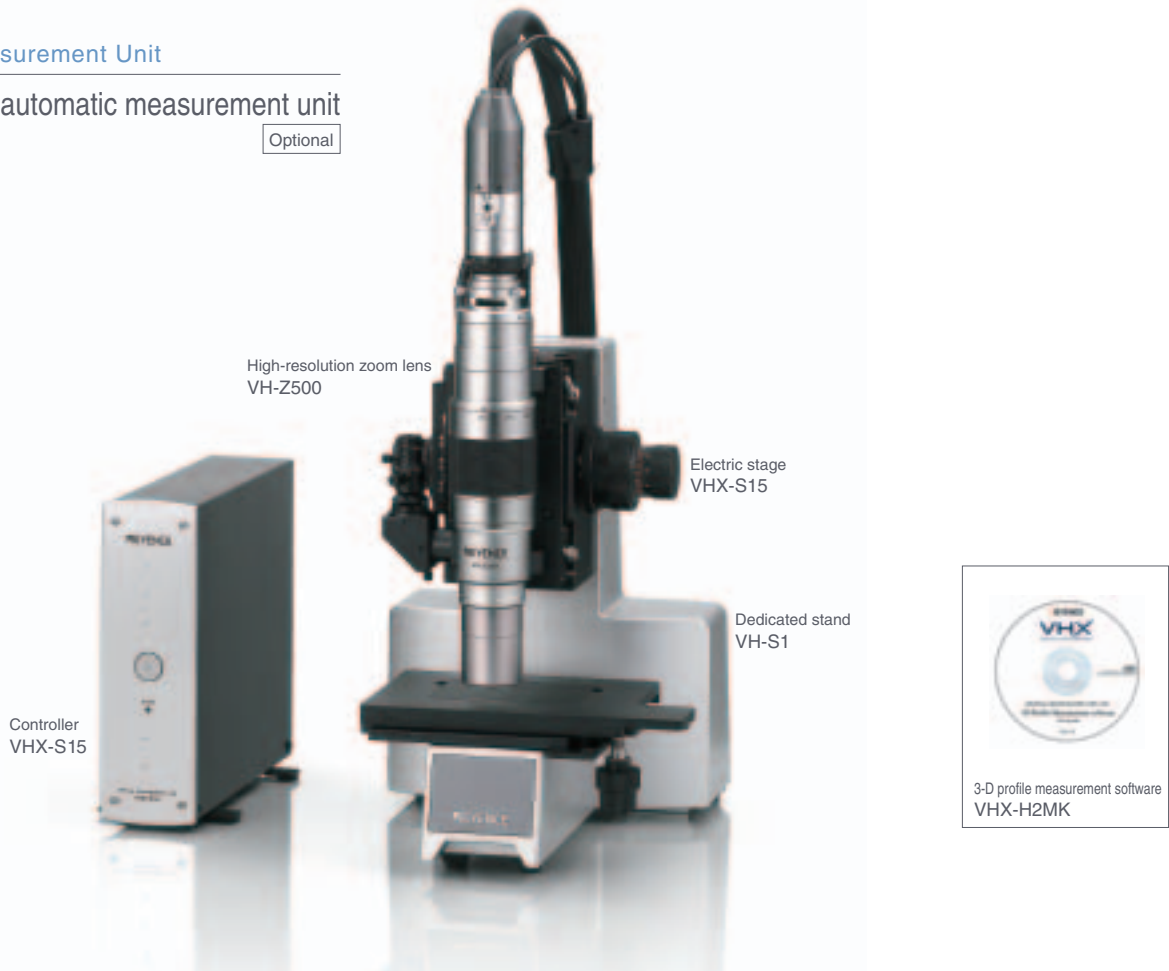

## 3-D profile measurement \* Function of the VHX-H2MK

The VHX-500 creates a 3-D image based on automatically captured images, and it calculates height profile data on a desired measuring line. Height, width and height difference data on the measuring line are plotted on a graph. Since the profile graph is related to the cursor position in the image display area, you can see the current measuring point easily.

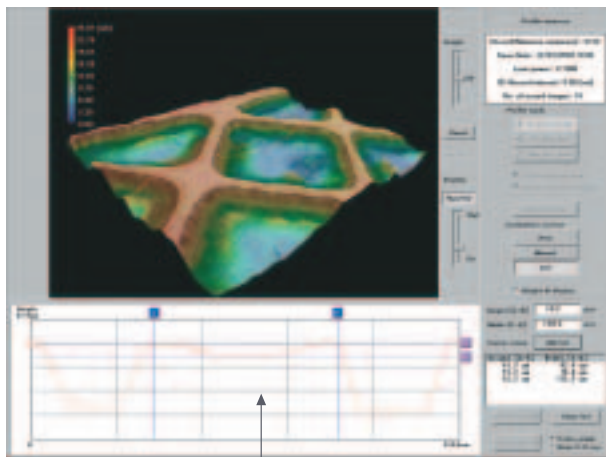

Printed board profile measurement

With the horizontal/vertical cursor, the height and width can be measured. The 2-line comparative mode can simultaneously display profile data on two parallel lines, enabling comparative analysis.

## Height color/scale display \* Function of the VHX-H2MK

Color bars that indicate height are displayed on a 3-D image. The highest position is displayed in red, and the lowest position is displayed in navy blue, allowing you to see a height difference at a glance. The height data can be superimposed on a raw image. Furthermore, the X-axis, Y-axis and Z-axis scales are calculated automatically and displayed according to the image size and the 3-D rotation angle.

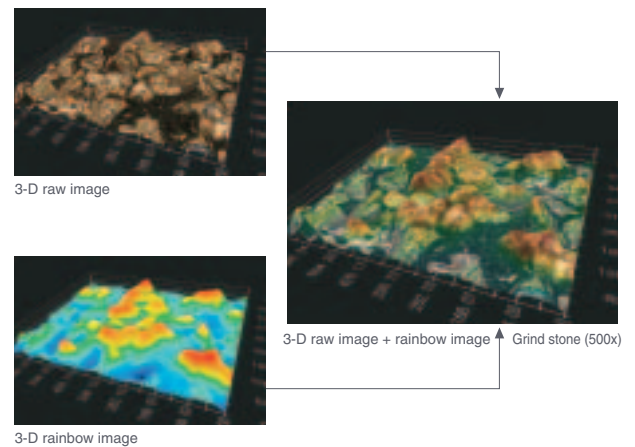

## 2-point height difference measurement

The VHX-500 can quickly and automatically measure a height difference between specified windows in the automatic measurement mode. In the manual measurement mode, you can measure a height difference between two points while monitoring a focus condition of details.

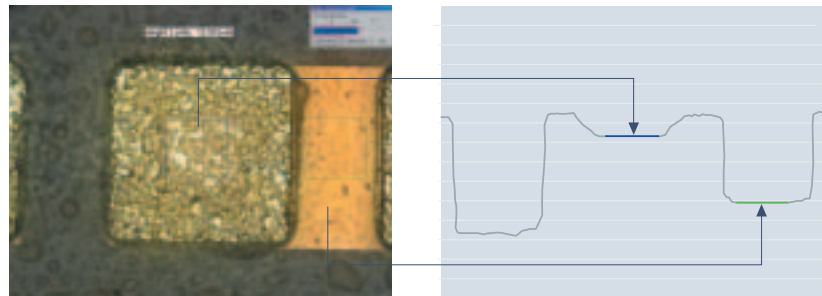

Bump (3000x)

## Auto focus function

This function enables anyone to perform high-magnification focus adjustment quickly and accurately. The auto focus function can be applied even to a target with uneven surface conditions, since the focusing area can be specified on the screen.



Chip resistor (500x)

Before focusing

After focusing

## All-in-one system

Centralized control of stage operation, observation and analysis

All steps from stage operation, zoom observation and 3-D analysis to image-saving and network connection are enabled in the VHX unit. You do not need a device or PC for stage operation or analysis. This system saves space and provides high operating efficiency.

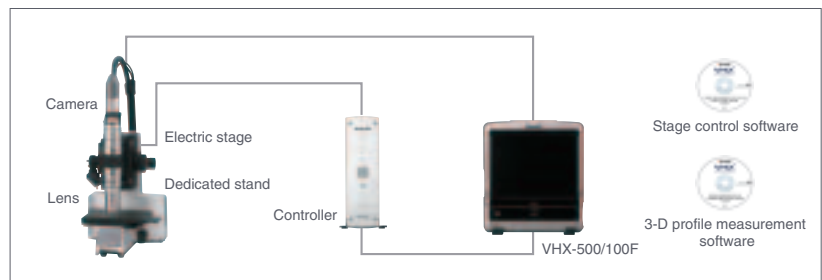

### Specifications

Model	VHX-S15	
Applicable lens	VH-Z500, VH-Z450, VH-Z100, VH-Z75	
Stage stroke distance	0.59" 15 mm	
Motor	5-phase stepping motor	
Resolution	0.002 Mil 0.05 μm/pulse	
Positioning accuracy *	0.23 Mil 6 μm	
Repeatability *	±0.02 Mil 0.5 μm	
Ratings	Power supply voltage	100 to 240 VAC, 50/60 Hz
	Power consumption	70 VA
Ambient temperature	+5 to 40°C (41 to 104°F)	
Relative humidity	35 to 80% RH (No condensation)	
Weight	Controller: 3 kg, Electric stage: 1.3 kg	
Load capacity	5 kg	

\*Typical value of electric stage single unit

### Option



Digital indicator set  
OP-51610

Digital indicator for direct measurement of the lens stroke distance, ensuring easy calibration

Application

Wide applications to meet the needs of various industries

Electric/Electronics

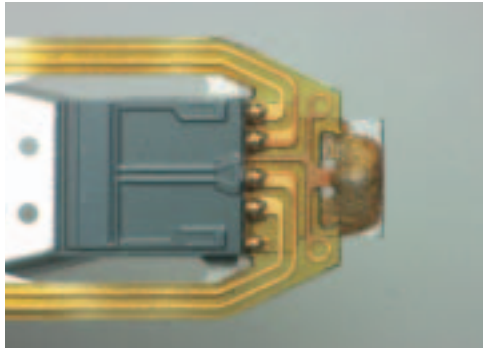

HDD head (100x)

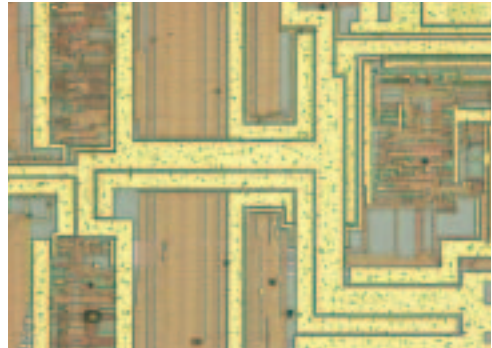

IC pattern (1000x)

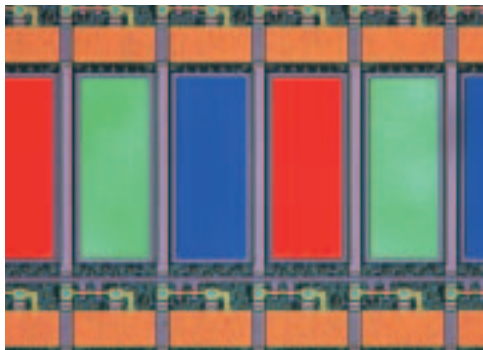

LCD (800x)

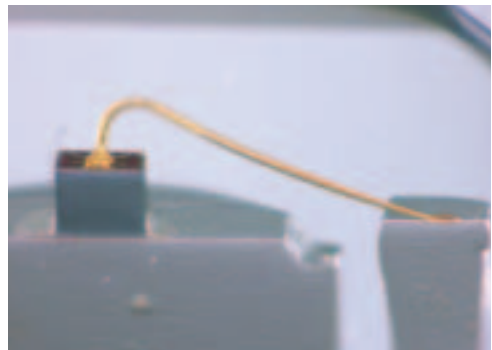

LED (200x)

Transportation/Metal Industries

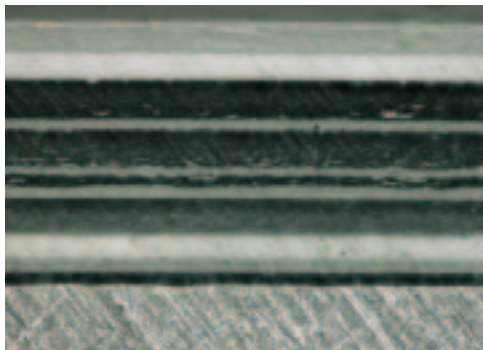

Fracture surface (500x)

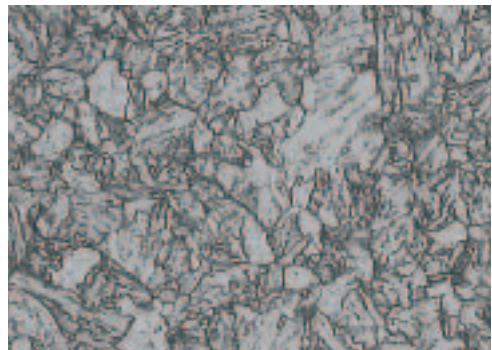

Microstructure of metal (400x)



Grind stone (500x)

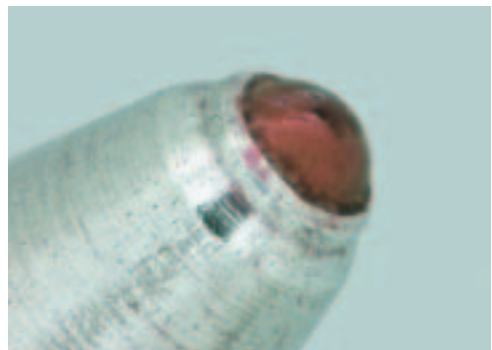

Tip of ballpoint pen (200x)



Material/Chemical industries

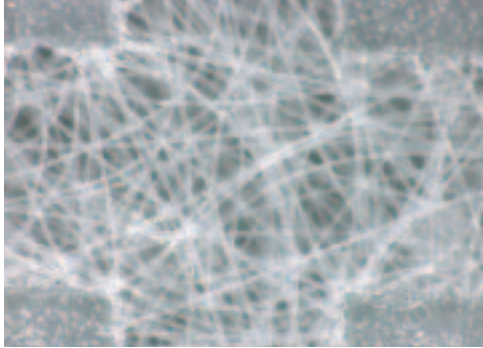

Non-woven fabric (150x)

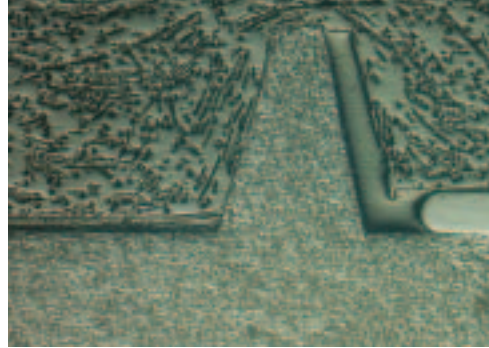

Glass fiber (200x)

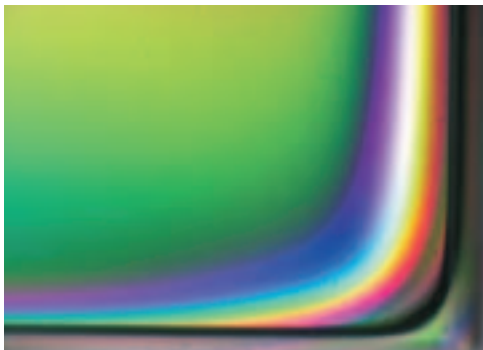

Residual stress on resin (100x)

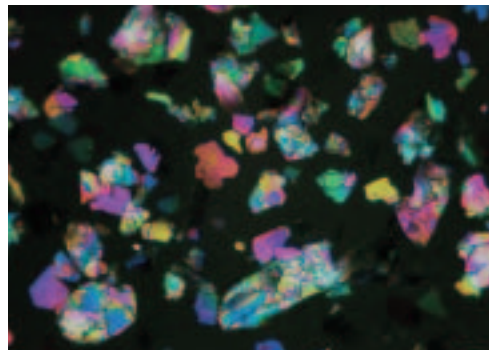

Mica (1000x)

Other industries

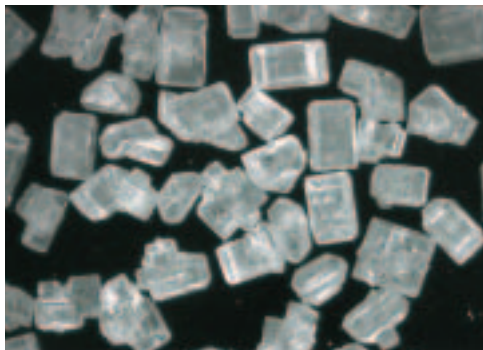

Food (Sugar) (50x)

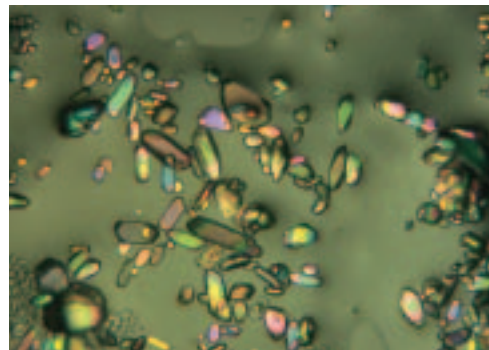

Chemical (Liquid agent) (500x)

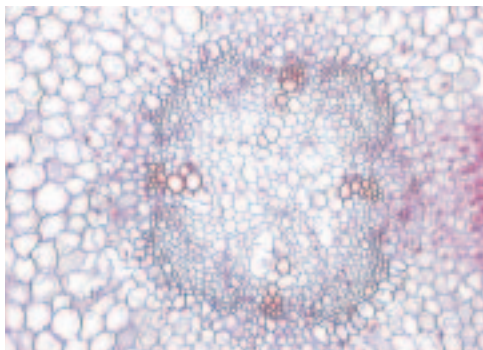

Plant (Broad bean) (300x)

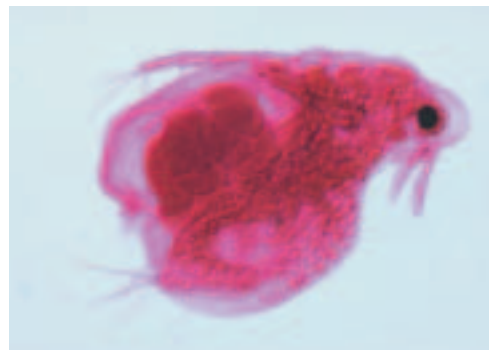

Living thing (Water flea) (300x)

Free angle System

**NEW** Free-angle observation system VH-S30  
(Ucentric system)

## Vibration Proof / Super High-accuracy

### EASY-TO-ADJUST

Easy adjustment of visual field(height), rotation, and oblique axis. A custom mechanism allows the target to stay in focus, even when the lens unit is inclined or rotated.

Visual field/height

Oblique axis

Rotation axis

### QUICK SETUP MARKS

The ideal setting position for different lenses is indicated on the arm.

### WEDGE-SHAPED CHANNEL

The mounting arm is held in place with a wedge-shaped channel. This prevents the arm from moving during observations.

### CABLE HOLDER

The cable is held in place, preventing vibration. The cable is also protected against abrasions and deterioration.

### STABILITY

The die-cast main body provides a highly rigid structure that allows for more stable observations.

### VIBRATION PROTECTION

Absorbs low to high frequency vibration, allowing for observation of specimens without interference.



# Easy to operate

## 1 SIMPLE ADJUSTMENT

It is easy to adjust the optical axes by simply positioning the stage at the indicated height. The instructions are provided on the base of the stage, allowing new users to immediately begin using the VH-S30. (Patent pending)

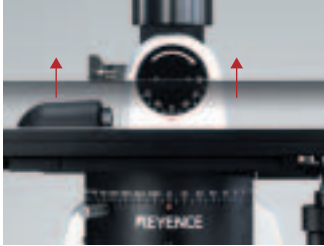

Easy adjustment of axes by fixing the stage at the upper limit.



Instructions printed on the stage.

## 2 FLEXIBLE OPERATION

Observation can be performed from any angle without moving the lens. You can instantly find the best position to observe an object. Since the VH-S30 does not use a mirror, it enables the user to observe objects as they normally appear. (Patent pending)



Observation from various angles by moving the pole.



360° observation.

# Excellent vibration protection

A special vibration proof material has been selected to insulate the VH-S30. It is designed to absorb a broad range of vibrations in order to provide stable images of highly magnified objects.

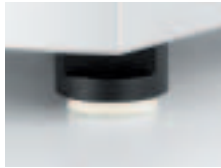

Vibration-protective material

The vibration protective rubber is the same material used for vision inspections systems and high-accuracy measurement devices in the semiconductor, R&D, and automotive industries.

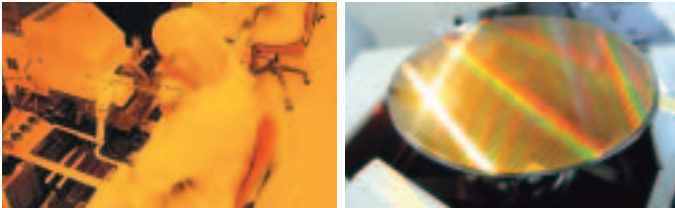

# Ultra precise mechanism

The stage combines the flexibility and ultra precision that are critical to a wide range of applications.



Super fine adjustment dial  
In addition to the course adjustment dial, the super fine adjustment dial can be adjusted in 5 μm steps.



Ultra precise bearing  
The oblique axis uses an ultra precise bearing to accurately position the central axis.

**VIEW**

Inclination

Rotation

Mounting components/solder (50x)

Right above
30°
60°

20°
60°
80°



## Providing high resolution in ultra-small size Ultra-small, high-performance zoom lens



**NEW**

### Ultra-small, high-performance zoom lens

20 200

VH-Z20

The VH-Z20 enables high-resolution observation at general-purpose magnifications of 20x to 200x. Furthermore, the “large depth of field”, which is the feature of the conventional VHX series, has been further intensified.

Model		VH-Z20					
Magnification <sup>1)</sup>		20x	30x	50x	100x	150x	200x
Monitor- ing range (inch/mm)	Horizontal	0.60° 15.24	0.40° 10.16	0.24° 6.10	0.12° 3.05	0.08° 2.03	0.06° 1.52
	Vertical	0.45° 11.40	0.30° 7.60	0.18° 4.56	0.09° 2.28	0.06° 1.52	0.04° 1.14
	Diagonal	0.75° 19.05	0.50° 12.70	0.30° 7.62	0.15° 3.81	0.10° 2.54	0.08° 1.91
Depth of field (inch/mm) <sup>2)</sup>		1.34* 34	0.61* 15.5	0.24* 6.0	0.06* 1.6	0.03* 0.74	0.02* 0.44
Monitoring distance (inch/mm)		0.00* 25.5					

1. Magnification on a 15-inch monitor

2. When priority is given to the depth of field. The depth of field varies depending on the diaphragm ring.

#### Features of the VH-Z20/Z100

#### Class-highest resolution: Approx. twice as high as conventional lenses

As a result of concentrating the expertise cultivated for microscopes over many years and the essence of KEYENCE optical technologies, the VH-Z20/Z100 provides class-highest resolution. The VH-Z20/Z100 lens maximizes the capacity of the microscope that tends toward advanced CCD imaging.

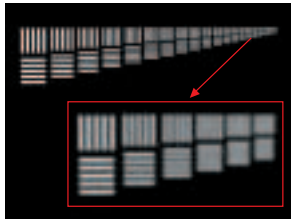

Conventional lens

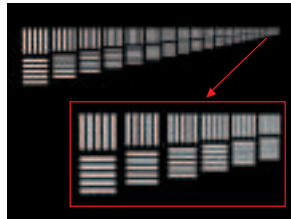

RZ lens

#### Excellent depth of field: Approx. twice as large as conventional lenses

The “large depth of field”, which is the greatest feature of the VHX Series microscope, has been intensified further. The VH-Z20/Z100 provides a larger depth of field than conventional lenses. You can observe a target easily with uneven surface conditions.

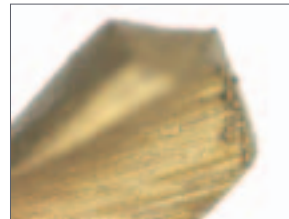

Drill tip (Optical microscope)

(100x)

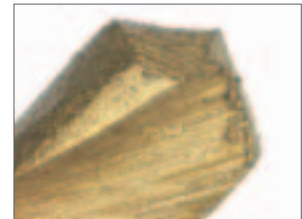

Drill tip (RZ lens)

(100x)

#### Optical adapter for the VH-Z20 (Z25)/Z100

##### Variable illumination adapter

With the KEYENCE-original optical mechanism, the variable illumination adapter covers both vertical illumination and lateral illumination without irregularity in the illuminating conditions. It enables optimal illumination for various targets.



VH-K25



Paper surface (200x)

Standard illumination



Variable illumination

##### Coaxial vertical illumination adapter

The coaxial vertical illumination adapter uses two groups of three lenses and a high-performance mirror multi-coated prism. Using this adapter, the microscope can retain sufficient light quantity for illumination. This adapter is useful for observation of metal microstructures, IC, etc. in a bright visual field.



OP-35416



IC (1000x)

When the adapter is not used (Dark visual field)

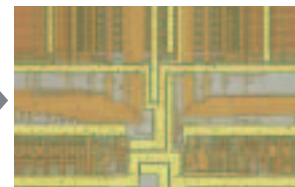

When the adapter is used (Bright visual field)

\* The above photo is the optical adapter for VH-Z20(Z25).



# Wide-range zoom lens offers high resolution and large depth of field



## Wide-range zoom lens



VH-Z100

This innovative lens was developed to satisfy the contradictory needs of high resolution and high depth of field for magnified observation.

Model		VH-Z100					
Magnification <sup>1.</sup>		100x	200x	300x	500x	700x	1000x
Monitoring range (inch/mm)	Horizontal	0.12" 3.05	0.06" 1.53	0.04" 1.02	0.02" 0.61	0.02" 0.44	0.01" 0.30
	Vertical	0.09" 2.28	0.04" 1.14	0.03" 0.76	0.02" 0.46	0.01" 0.33	0.01" 0.23
	Diagonal	0.15" 3.81	0.07" 1.90	0.05" 1.27	0.03" 0.76	0.02" 0.54	0.01" 0.38
Monitoring distance (inch/mm)		0.98" (0.79") 25 (20")					

1. Magnification on a 15-inch monitor
2. When the ring illumination adapter is attached

### Wide range zoom: Optical zoom at 10x magnification

The VH-Z100 is designed for a wide zoom range, seamlessly covering from the whole image to an enlarged view of a target. Since the VH-Z100 retains a constant observation distance throughout the zoom range, it can improve operating efficiency. It is an all-around zoom lens applicable to any scene.

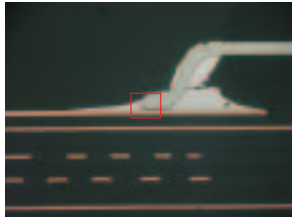

Solder cross-section



(100x)

(1000x)

### Highly-telecentric zoom lens

With the highly-telecentric lens design, the RZ lens can create extremely clear and perfect depth composition images and 3-D images. The RZ lens can make the best use of the digital focus functions that are the essential feature of the VHX Series.



Battery safety valve

(700x)

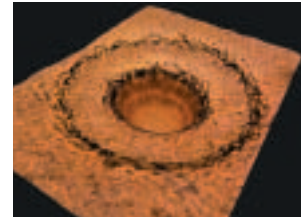

Electrode hole

(1000x)

### Polarization illumination adapter

Effective for suppressing glare during observation through a transparent film or coating.



OP-35415



Printed material (30x)

standard illumination



polarizing illumination

### Diffuse illumination

You can observe real surface conditions without the glare of a target. The diffuse illumination adapter covers both vertical illumination and lateral illumination, enabling optimal illumination for various targets.

Diffuse illumination adapter  
OP-35324

Multi-diffuse adapter  
OP-35469

Super-diffuse illumination adapter  
OP-42305

Non-contact diffusion adapter  
OP-35414

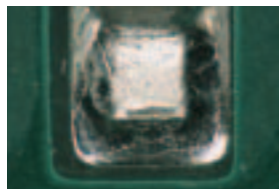
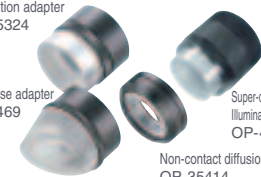

Solder (200x)

standard illumination



diffuse illumination

# High-resolution zoom lens is the pinnacle of optical lenses



## High-resolution zoom lens

VH-Z500

500 → 5000

This zoom lens provides class-highest resolution. This is the advent of a new zoom lens that can skillfully express advanced 3D images and disproves common practice in observation.

Model	VH-Z500					
Magnification <sup>1</sup> :	500x	1000x	2000x	3000x	5000x	
Monitoring range (inch/mm)	H (Horizontal)	24.02" 610	12.01" 305	5.98" 152	4.02" 102	2.4" 61
	V (Vertical)	17.99" 457	9.02" 229	4.49" 114	2.99" 76	1.81" 46
	D (Diagonal)	30" 762	15" 381	7.52" 191	5" 127	2.99" 76
Observation distance (inch/mm)	0.17" 4.4					

1. Magnification on a 15-inch monitor

### Features of the VH-Z500

#### Numerical aperture (N.A.) of 0.82 at a distance of 0.17" (4.4 mm)

The VH-Z500 is equipped with 24 high-performance lenses in total, which are supported by advanced grinding technology. In addition, the VH-Z500 uses a large-diameter spherical lens, providing an observation distance of 0.17" (4.4 mm). The VH-Z500 is an ideal zoom lens that provides both high resolution and high operability.



HDD head (1500x)

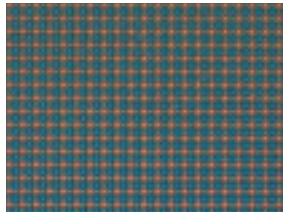

CCD (2000x)

#### Optical 10x zoom from 500x to 5000x magnification

The development of this high-resolution lens with almost no optical aberration easily provides a zoom range 10 times wider than conventional models. High-resolution images with minimum distortion can be obtained within the entire zoom range.



TFT (500x)



TFT (5000x)

#### Polarizing illumination mechanism Option

The polarizing illumination mechanism prevents unnecessary reflected light from an observation target to adjust the light quantity to an optimal level. It is suitable for shooting a target through a transparent film.

### Zoom lens



### Zoom lens

VH-Z25

25 → 175

A single lens unit covers 25x to 175x magnifications.

The VH-Z25 can continuously change magnification from 25x to 175x without the need for lens replacement. You can quickly find an observation point at low magnification and then directly zoom in on the observation point. The VH-Z25 provides two types of illumination heads (contact type and non-contact type) as standard equipment. The non-contact type illumination head provides an observation distance of 1.00" (25.5 mm), improving your operating efficiency.

When many illumination adapters are attached, the zoom lens is applicable to various observation purposes. (See p. 24.)

Model	VH-Z25				
Magnification <sup>1</sup> :	25x	50x	100x	175x	
Monitoring range (inch/mm)	Horizontal	0.48" 12.20	0.24" 6.10	0.12" 3.05	0.07" 1.74
	Vertical	0.36" 9.10	0.18" 4.55	0.09" 2.28	0.05" 1.30
	Diagonal	0.60" 15.24	0.30" 7.62	0.15" 3.81	0.09" 2.18
Depth of field (inch/mm)	0.51" 13.0	0.12" 3.0	0.03" 0.7	0.01" 0.3	
Monitoring distance of the non-contact type illumination head (inch/mm)	00.0" 25.5				

1. Magnification on a 15-inch monitor

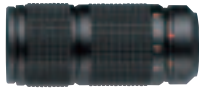

## Low-range zoom lens | VH-Z05

0 ▶ 40

### 0x to 40x magnification for viewing the entire target

This low-range zoom lens provides a magnification of between 0x and 40x, enabling the entire target to be monitored as well as providing a magnified view. You can easily capture an image of the whole target without using an external camera, perfect for inserting into your report or reference document. The monitoring distance is 3.74" (95 mm) or more, ensuring improved workability.

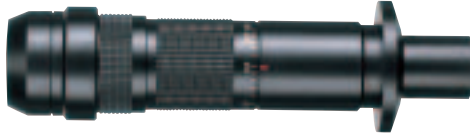

## Long-focal-distance zoom lens | VH-Z35

35 ▶ 245

### 35x to 245x magnification at a distance of 2.13" (54 mm)

With a monitoring distance of 2.13" (54 mm) and extremely high depth-of-field, this lens provides a convenient way to monitor a target with height differences on the surface. This wide working space greatly increases monitoring efficiency. With a single lens, you can monitor from a low magnification (35x) to a high magnification (245x), allowing the desired point to be quickly enlarged.



## Middle-range zoom lens | VH-Z150

150 ▶ 800

### 150x to 800x magnification, enabling a bright image to be monitored

This middle-range zoom lens allows continuous changes in magnification of between 150x and 800x. It can be used to monitor at a distance 0.47" (12 mm) at 800x magnification. The illumination head can be switched to a coaxial vertical illumination type to enable detailed observation of Microstructure of metal or a semiconductor surface.

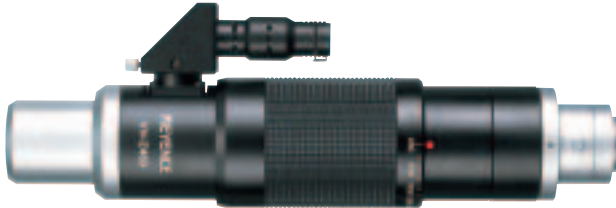

## High-range zoom lens | VH-Z450

450 ▶ 3000

### 450x to 3000x magnification, enabling monitoring with vertical/penetration illumination.

This high-range zoom lens allows continuous changes in magnification of between 450x and 3000x. The high-resolution lens and optical edge enhancement function ensure higher reproduction than a conventional microscope.

The lens provides a magnification of 3000x at a monitoring distance of 0.29" (7.3 mm), ensuring improved workability. A special stand with penetration illumination is also available, further expanding the applications of this lens.

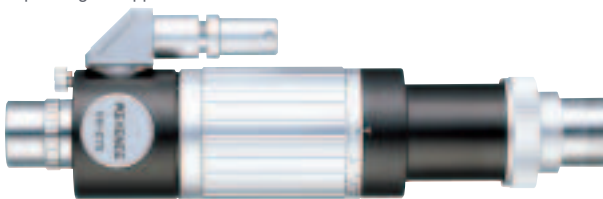

## HD middle-range zoom lens | VH-Z75

75 ▶ 750

### 75x to 750x magnification

This lens allows continuous changes in magnification between 75x and 750x. The high-quality lens offers excellent resolution. The monitoring distance of 1.82" (46.2 mm) at 750x greatly improves workability. This lens achieves high performance surpassing conventional microscopes in both image quality and workability.



Non-reflective illumination ring (Optional)  
OP-32009

Model		VH-Z05						
Magnification <sup>1</sup> :		0.1x	0.5x	1x	5x	10x	20x	40x
Monitoring range (inch/mm)	Horizontal	125.98" 3200	25.20" 640	12.60" 320	2.40" 61.0	1.20" 30.5	0.60" 15.3	0.30" 7.6
	Vertical	94.49" 2400	18.90" 480	9.45" 240	1.79" 45.5	0.90" 22.8	0.45" 11.4	0.22" 5.7
	Diagonal	157.48" 4000	31.50" 800	15.75" 400	3.00" 76.2	1.50" 38.1	0.75" 19.0	0.37" 9.5
Monitoring distance (inch/mm)		Approx. 25.3" 7.7m		Approx. 4.9" 1.5m	Approx. 0.8" 22mm	3.74" 95mm		

1. Magnification on a 15-inch monitor



Coaxial vertical illumination adapter (Optional)  
OP-35416

Model		VH-Z35					
Magnification <sup>1</sup> :		35x	50x	100x	150x	200x	245x
Monitoring range (inch/mm)	Horizontal	0.34" 8.71	0.24" 6.10	0.12" 3.05	0.08" 2.03	0.06" 1.53	0.05" 1.24
	Vertical	0.26" 6.5	0.18" 4.55	0.09" 2.28	0.06" 1.52	0.04" 1.14	0.04" 0.93
	Diagonal	0.43" 10.89	0.30" 7.62	0.15" 3.81	0.10" 2.54	0.07" 1.90	0.06" 1.56
Depth of field (inch/mm)		0.33" 8.3	0.20" 5.0	0.04" 1.0	0.20" 5.0	0.02" 0.4	0.01" 0.3
Monitoring distance (inch/mm)		2.13" 54.0					

1. Magnification on a 15-inch monitor



Adjustable illumination adapter (Optional)  
VH-K150

Model		VH-Z150			
Magnification <sup>1</sup> :		150x	200x	500x	800x
Monitoring range (inch/mm)	Horizontal	0.08" 2.03	0.06" 1.53	0.02" 0.61	0.02" 0.38
	Vertical	0.06" 1.52	0.05" 1.14	0.02" 0.46	0.01" 0.28
	Diagonal	0.10" 2.54	0.08" 1.90	0.03" 0.76	0.02" 0.48
Monitoring distance (inch/mm)		0.47" 12.0 <sup>2</sup>			

1. Magnification on a 15-inch monitor

2. 0.25" (6.5 mm) when the coaxial vertical illumination ring is attached.

Model		VH-Z450						
Magnification <sup>1</sup> :		450x	500x	1000x	1500x	2000x	2500x	3000x
Monitoring range (inch/mm)	Horizontal	0.03" 0.68	0.03" 0.61	0.01" 0.31	0.01" 0.20	0.01" 0.15	0.004" 0.12	0.003" 0.10
	Vertical	0.02" 0.51	0.02" 0.46	0.009" 0.23	0.006" 0.15	0.004" 0.11	0.004" 0.09	0.003" 0.08
	Diagonal	0.03" 0.85	0.03" 0.76	0.01" 0.38	0.01" 0.25	0.007" 0.19	0.006" 0.15	0.005" 0.13
Monitoring distance (inch/mm)		0.29" 7.3						

1. Magnification on a 15-inch monitor

Model		VH-Z75					
Magnification <sup>1</sup> :		75x	150x	300x	450x	600x	750x
Monitoring range (inch/mm)	Horizontal	0.16" 4.07	0.08" 2.03	0.04" 1.02	0.03" 0.68	0.02" 0.51	0.02" 0.41
	Vertical	0.12" 3.04	0.06" 1.52	0.03" 0.76	0.02" 0.51	0.01" 0.38	0.01" 0.30
	Diagonal	0.20" 5.08	0.10" 2.54	0.05" 1.27	0.03" 0.85	0.03" 0.64	0.02" 0.51
Monitoring distance (inch/mm)		1.82" 46.2					

1. Magnification on a 15-inch monitor

## Borescope

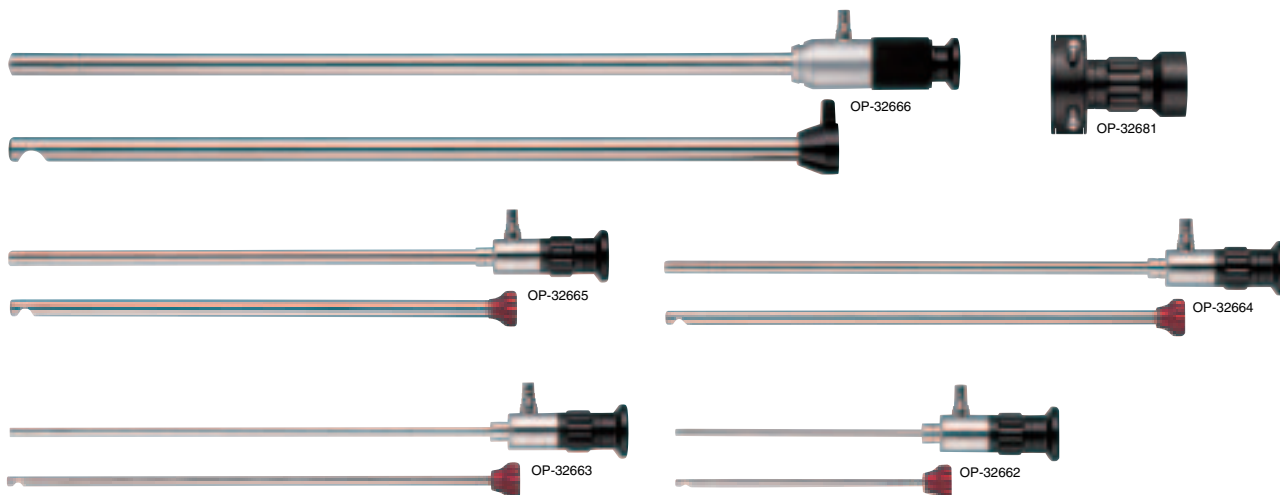

### Borescope lens | OP-32662 / 32663 / 32664 / 32665 / 32666

Two observation directions (direct view and lateral view) are enabled with a single unit.

The borescope unit provides a 90° lateral view attachment as standard equipment, enabling observation directions to be switched between direct view and lateral view. Five types of bore diameters  $\phi 0.16"$ ,  $\phi 0.22"$ ,  $\phi 0.31"$ ,  $\phi 0.39"$  and  $\phi 0.55"$  ( $\phi 4$ ,  $\phi 5.5$ ,  $\phi 8$ ,  $\phi 10$  and  $\phi 14$ ) are available, allowing you to select an appropriate diameter according to your observation purpose. The monitoring magnification is 80x to 360x, 1.2 to 5 times larger than conventional models. You can clearly observe even minute targets that cannot be observed with conventional models.

Model	OP-32662	OP-32663	OP-32664	OP-32665	OP-32666
Lens attachment	OP-32681				
Outer diameter (inch mm)	$\phi 0.16"$ $\phi 4.0$	$\phi 0.17"$ $\phi 4.4$	$\phi 0.22"$ $\phi 5.5$	$\phi 0.23"$ $\phi 5.9$	$\phi 0.31"$ $\phi 8.0$
Effective length (inch mm)	5.31" 135	9.84" 250	9.84" 250	9.84" 250	16.53" 420
View direction	0° (direct view) 90° (Lateral view)	0° (direct view) 90° (Lateral view)	0° (direct view) 90° (Lateral view)	0° (direct view) 90° (Lateral view)	0° (direct view) 90° (Lateral view)
View angle	35°		40°		
Observation distance (inch mm)	0.10" to $\infty$ 2.5 to $\infty$	0.11" to $\infty$ 2.7 to $\infty$	0.14" to $\infty$ 3.5 to $\infty$	0.11" to $\infty$ 2.7 to $\infty$	0.39" to $\infty$ 10 to $\infty$
Maximum observation magnification	230x	360x	175x	190x	80x
Minimum view range	0.04" 1.1	0.03" 0.7	0.06" 1.5	0.06" 1.4	0.13" 3.3
Ambient temperature	Sleeve: 0 to 40°C except for sleeve: 0 to 40°C				

1. 0°: When the direct-view standard lens is attached. 90°: When the lateral-view attachment is attached
2. Magnification around the center of the 15-inch monitor screen
3. Horizontal view range



### Borescope lens | VH-B31 / B32 / B61 / B64

$\phi 3$ -mm sleeve for viewing inside a narrow gap

The 3-mm sleeve diameter enables you to easily monitor inside a narrow gap or complicated shape. Select from two types of end shapes: Direct-view and oblique-view. Only the lens is contained in the sleeve, enabling excellent resolution. The borescope lens is completely waterproof for underwater observation.

\*In addition to the above, many size variations are available. For more information, contact the nearest KEYENCE sales office.

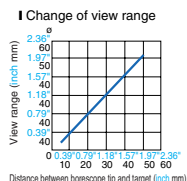
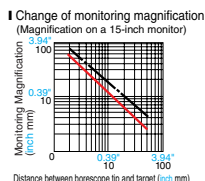

Model	VH-B31	VH-B32	VH-B61	VH-B64
Lens attachment	VH-B			
Outer diameter (inch mm)	$\phi 0.12"$ $\phi 3$ (Protective tube: $\phi 0.16"$ $\phi 4$ )		$\phi 0.24"$ $\phi 6$	
Effective length (inch mm)	4.13" 105	4.21" 107	11.81" 300	11.97" 304
View direction	0° (direct view)	30° (oblique view)	0° (direct view)	70° (oblique view)
View angle	55°			
Observation depth (inch mm)	0.08" to 1.97" 2 to 50			
View range (inch mm)	$\phi 0.08"$ to $\phi 2.05"$ $\phi 2$ to $\phi 52$			
Protection	Sleeve: Waterproof			
Ambient temperature	0 to +40°C (32 to 104°F) (in air/water)			

— VH-B31/B32  
- - - VH-B61/B64

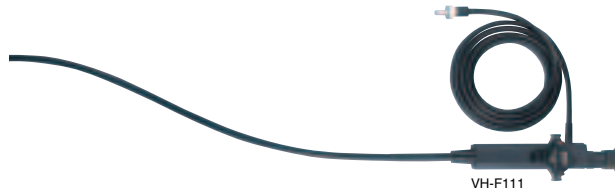
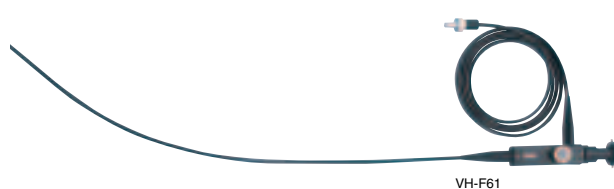

### Fiberscope | VH-F61 / F111

Monitoring a complicated shape

The fiberscope allows you to monitor places where conventional lenses cannot be used, such as the inside of a complicated machine or a narrow, bending pipe. You can even monitor blind spots by changing the angle of the top of the fiberscope remotely.

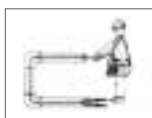

Model	VH-F61	VH-F111
Lens attachment	VH-F	
Outer diameter (inch mm)	$\phi 0.24"$ $\phi 6.1$	$\phi 0.43"$ $\phi 11$
Effective length (inch mm)	39.37" 1000	59.06" 1500
View direction	Direct view	
View angle	65°	55°
Observation depth (inch mm)	0.39" to $\infty$ 10 to $\infty$	0.79" to $\infty$ 20 to $\infty$
Bendable sleeve angle	120° up/down, 100° right/left	
Ambient temperature	+10 to +80°C (+50 to +176°F)	
Operating atmospheric pressure	1 atm	
Oil & waterproof	Machine oil and light oil	



## Fixed lens

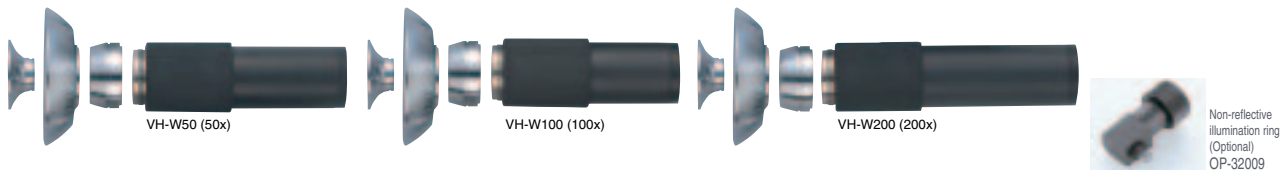

## Long-focal-distance lens | VH-W50/W100/W200

### Working while monitoring target

The long-focal-distance lens provides a long monitoring distance of 2.36" to 3.07" (60 to 78 mm), allowing you to continue working while monitoring a target. You can view clear images even when close monitoring is impossible, such as a target in a recess or the presence of a glass plate between the lens and target.



## Hyper-view lens | VH-V100/V200

### Easy monitoring of a glossy target with minimum halation

The hyper-view lens suppresses halation (reflection) from a glossy surface, enabling detailed monitoring. You can easily detect a flaw, stain or crack on metal, glass or ceramic surfaces that are difficult to detect using conventional microscopes.



## Vertical-illumination lens | VH-C501/C1001

### Monitoring metal surfaces

The vertical-illumination lens utilizes our original optical system to give it a thin body. You can clearly monitor Microstructure of metal or a semiconductor surface, which are hard to see using conventional lateral illumination. Two models are available with magnification factors 500x and 1000x.

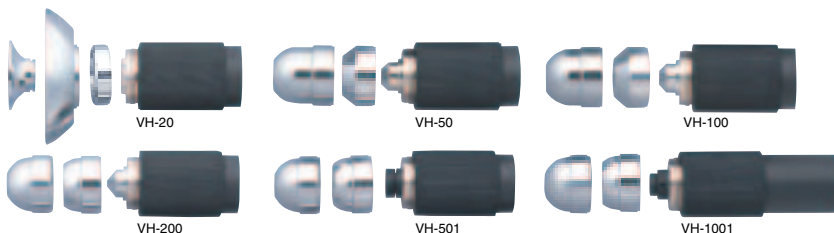

## Fixed-magnification lens | VH-20/50/100/200/501/1001

### Lens selection based on desired magnification

Select your desired magnification from between 20x and 1000x. These fixed-magnification lenses provide a larger depth-of-field than conventional microscopes, enabling you to obtain a sharp 3-D image. Two types of illumination heads are included: Contact and non-contact (except for VH-20).

## Peripheral equipment

### Keyboard

#### Useful for entry of detailed observation data for recording files

Comments and observation conditions (lens and magnification data used for recording files) can be entered with the keyboard. Your DOS/4 PS2 type keyboard can also be connected.

### Footswitch

#### Foot operation is enabled even if your hands are full.

During handheld operation, you can stop and record an image with the foot switch, even if both hands are full or you cannot reach the operation panel. (Commercially available)



Model	VH-W50	VH-W100	VH-W200	
Magnification <sup>1</sup> :	50x	100x	200x	
Monitoring range (inch/mm)	Horizontal	0.24" 6.10	0.12" 3.05	0.06" 1.53
	Vertical	0.18" 4.55	0.09" 2.28	0.04" 1.14
	Diagonal	0.30" 7.62	0.15" 3.81	0.07" 1.90
Depth of field (inch/mm)	0.12" 3.1	0.02" 0.6	0.01" 0.3	
Monitoring distance (inch/mm) <sup>2</sup> :	3.07"(3.03") 78(77)	2.36" (2.32") 60(59)	2.36" (2.32") 60(59)	

1. Magnification on a 15-inch monitor

2. Figures in parentheses are applicable when a non-reflective illumination head is used.

Model	VH-V100	VH-V200	
Magnification <sup>1</sup> :	100x	200x	
Monitoring range (inch/mm)	Horizontal	0.12" 3.05	0.06" 1.53
	Vertical	0.09" 2.28	0.04" 1.14
	Diagonal	0.15" 3.81	0.07" 1.90
Depth of field (inch/mm)	0.04" 1.0	0.02" 0.4	

1. Magnification on a 15-inch monitor

Model	VH-C501	VH-C1001	
Magnification <sup>1</sup> :	500x	1000x	
Monitoring range (inch/mm)	Horizontal	0.02" 0.61	0.01" 0.31
	Vertical	0.02" 0.46	0.01" 0.23
	Diagonal	0.03" 0.76	0.01" 0.38
Depth of field (inch/mm)	0.002" 0.06	0.001" 0.03	
Monitoring distance (inch/mm)	0" to 0.08" 0 to 2.0	0" to 0.08" 0 to 2.0	

1. Magnification on a 15-inch monitor

Model	VH-20	VH-50	VH-100	VH-200	VH-501	VH-1001	
Magnification <sup>1</sup> :	20x	50x	100x	200x	500x	1000x	
Monitoring range (inch/mm)	Horizontal	0.60" 15.25	0.24" 6.10	0.12" 3.05	0.06" 1.53	0.02" 0.61	0.01" 0.31
	Vertical	0.45" 11.38	0.18" 4.55	0.09" 2.28	0.04" 1.14	0.02" 0.46	0.01" 0.23
	Diagonal	0.75" 19.05	0.30" 7.62	0.15" 3.81	0.07" 1.90	0.03" 0.76	0.01" 0.38
Depth of field (mm)	0.47" 12.0	0.26" 6.5	0.04" 1.0	0.02" 0.4	0.002" 0.06	0.001" 0.03	
Monitoring distance (inch/mm)	2.76"(2.44") 70(62) <sup>2</sup>	0.50" 12.5	0.43" 11.0	0.14" 3.5	0.14" 3.5	0.14" 3.5	

1. Magnification on a 15-inch monitor

2. The figure in parentheses is applicable when a non-reflective illumination head is used.



## Ultimate depth of field

### Quick, high-quality depth composition

An image of the desired area with poor focus can be composed automatically by simply turning the focus-adjustment knob while observing the real-time image on the screen. As a result, the time and labor required for composing images can be reduced dramatically. In addition, KEYENCE's original image-processing technology enables high-speed display of large images (UXGA).

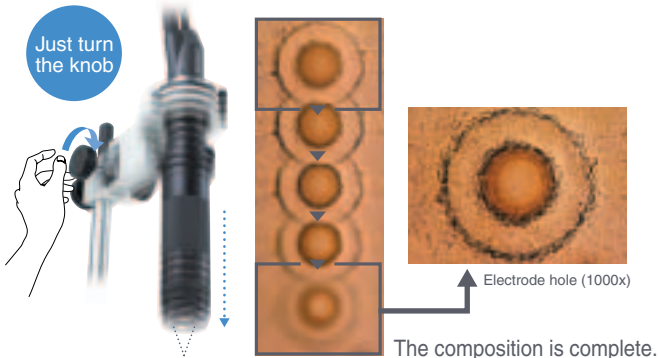

## Extensive expression ability

### D.F.D 3-D display function

The VHX-500 employs "hybrid D.F.D. method", an enhancement of the conventional D.F.D. method. It also employs the state-of-the-art digital technologies while preserving the function that can create 3D images using a small number of images where their focal positions differ.

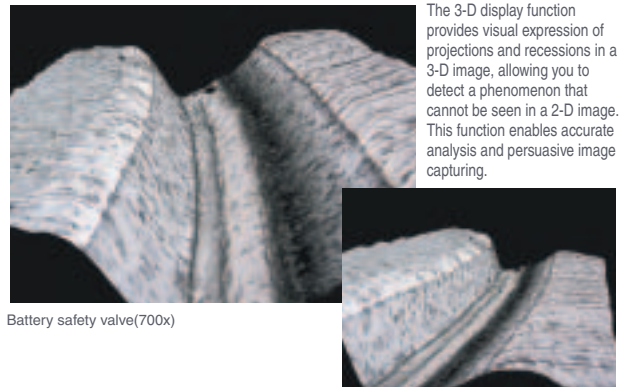

Digital Photo Printer

Digital Photo Printer DP-500

This next-generation printer satisfies the needs of research, development and manufacturing fields.



5 million-pixel, high-definition printing (Automatically compresses 18 million-pixel images.)

This printer provides image quality of 385-dpi, which is close to film photographs. The maximum printing size is 2564 x 1920 pixels 6.65" x 5.00" (169 x 127 mm) with a print quality of 5 million pixels. The DP-500 boasts an excellent printing quality that enables the detailed recognition of precise images.

Colors will not fade. Over-coated printing is supported as standard.

Over-coated printing with excellent light, heat, and moisture resistance is provided as standard. Durability of 100 years or longer is ensured for printouts stored in albums. Colors will not deteriorate, enabling accumulation of an accurate database.

High capacity and small footprint. 1.5 times greater capacity and 50% smaller footprint.

200 L-size prints can be printed consecutively. While providing a large capacity, a sleek stand-up design is realized with approximately one half of the footprint (compared to KEYENCE conventional models). The DP-500 is easy to install in a limited space such as laboratories for providing printouts on the spot when needed.

Easy storage. Fits nicely into albums.

The sheet size is small enough to fit into off-the-shelf albums or refill pocket sheets for photographs. Unlike conventional printers, there is no need to cut the photograph to a smaller size. The printed photograph can be filed as is, further eliminating the time and labor required for conventional models.

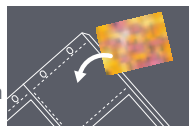

Notes are printed simultaneously. Photographs can be sorted out accurately and easily.

Comments appended to the image can be printed on the margin when printing images, eliminating the time and labor required for writing the descriptions afterward. A database that is easy to access for anyone can be constructed easily.

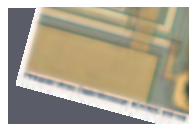

I Dimensions

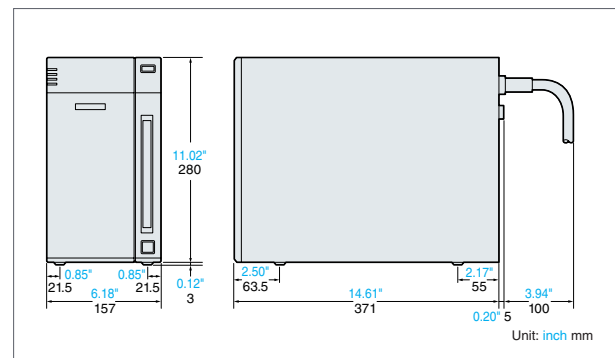

I Specifications

<b>Model</b>	<b>DP-500</b>
<b>Print method</b>	Sublimite thermal print
<b>Resolution</b>	385 dpi, 2564 x 1920 pixels max. (2L size)
<b>Tone level</b>	256 levels for Y, M, and C respectively, full color of approx. 16,770,000 colors
<b>Sheet/print size</b>	Standard: 5.00" x 4.02" 127 x 102 mm (1920 x 1544 pixels) L: 5.00" x 3.74" 127 x 95 mm (1920 x 1444 pixels) 2L: 6.65" x 5.00" 169 x 127 mm (2564 x 1920 pixels) L-print: 5.00" x 3.42" 127 x 89 mm (1920x 1348 pixels)
<b>Printing time</b>	Approx. 40 seconds (L size)
<b>Paper feed method</b>	Machine-glazed paper system
<b>Interface</b>	USB1.1
<b>Supporting OS</b>	Windows® XP/2000/Me/98 Second Edition <sup>1</sup> .
<b>Power supply</b>	100 to 240V AC 50/60 Hz
<b>Current consumption</b>	250 VA max. during printing
<b>Ambient temperature</b>	5 to 40°C (41 to 104°F), No condensation
<b>Relative humidity</b>	20 to 80%, No condensation
<b>Dimensions</b>	6.18" (W) x 11.02" (H) x 14.61" (D) 157 x 280 x 371 mm
<b>Weight</b>	11kg

<sup>1</sup>. Windows XP/2000/Me/98 Second Edition are registered trademarks of Microsoft Corporation, U.S.A.

# VHX Series System Line Up

## System configuration

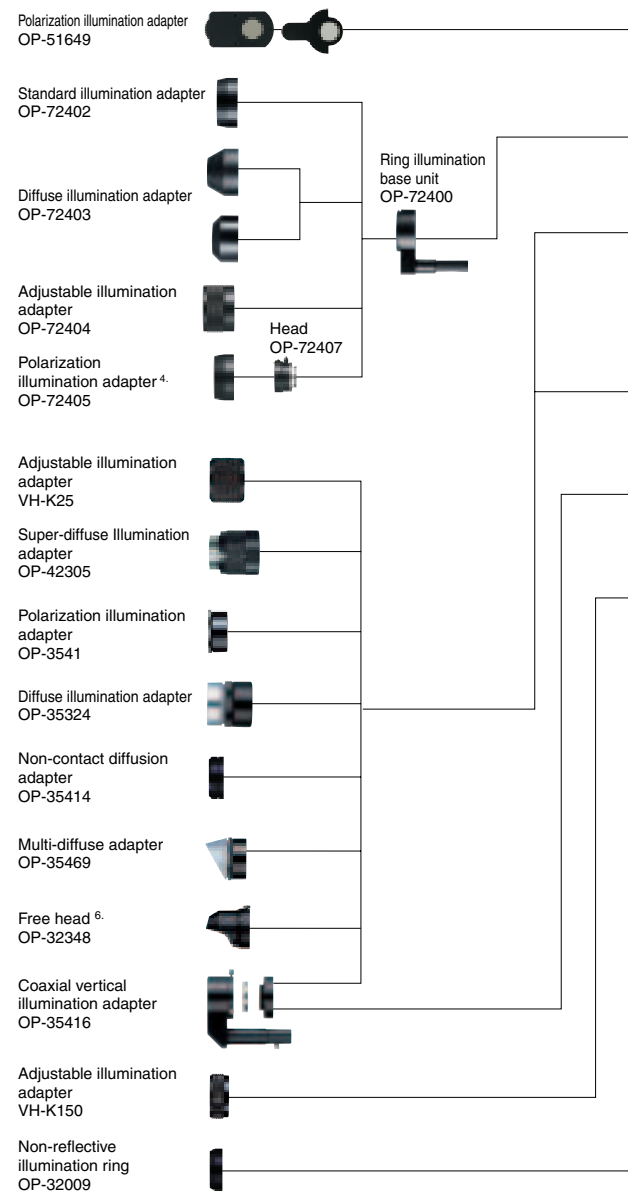

### LONG-FOCAL-DISTANCE LENS

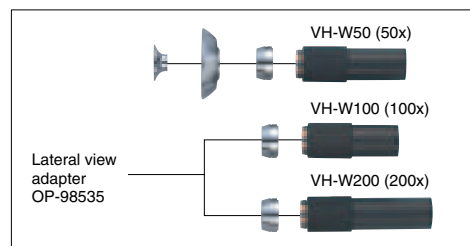

### FIXED-MAGNIFICATION LENS

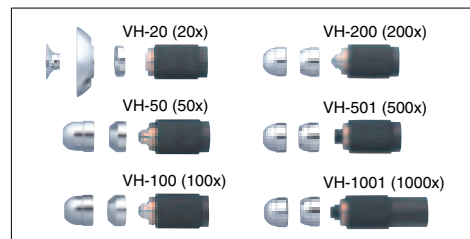

### RZ LENS

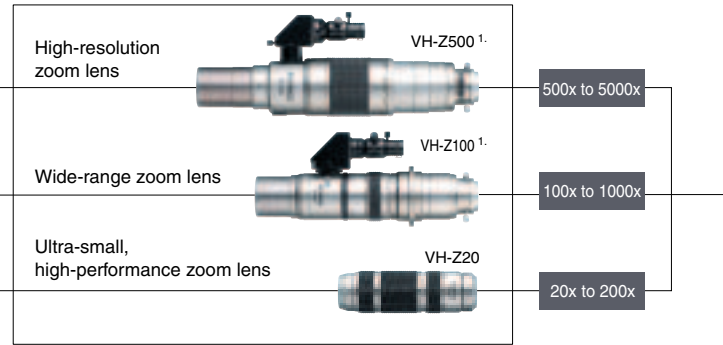

### ZOOM LENS

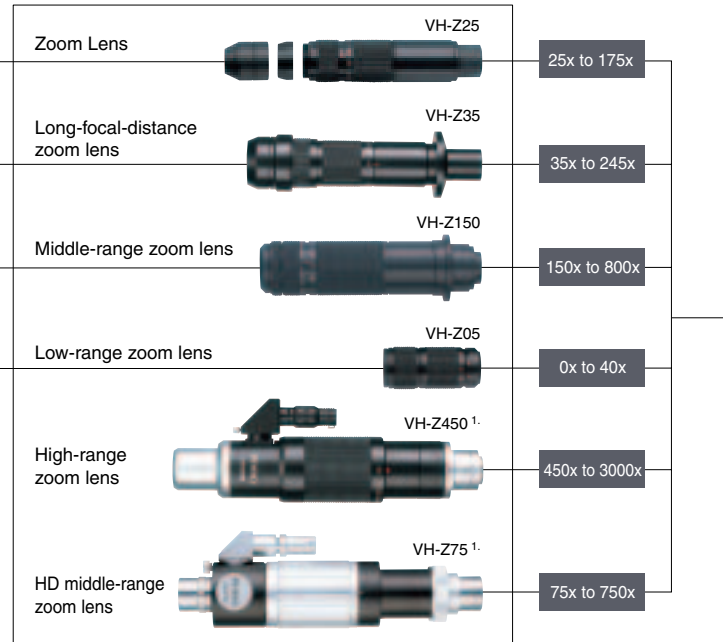

### HYPER-VIEW LENS

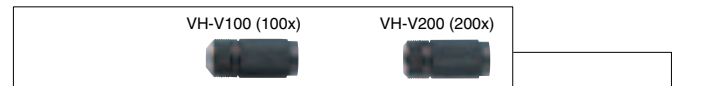

### VERTICAL-ILLUMINATION LENS



### BORESCOPE LENS



### BORESCOPE LENS

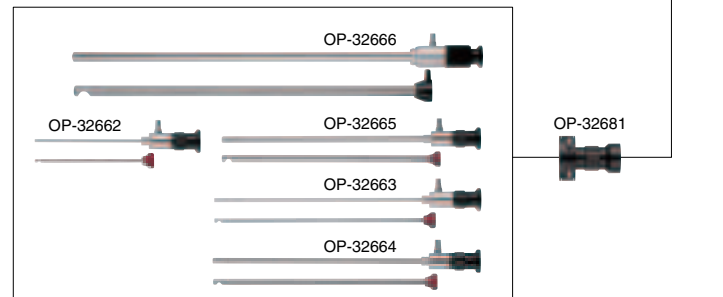



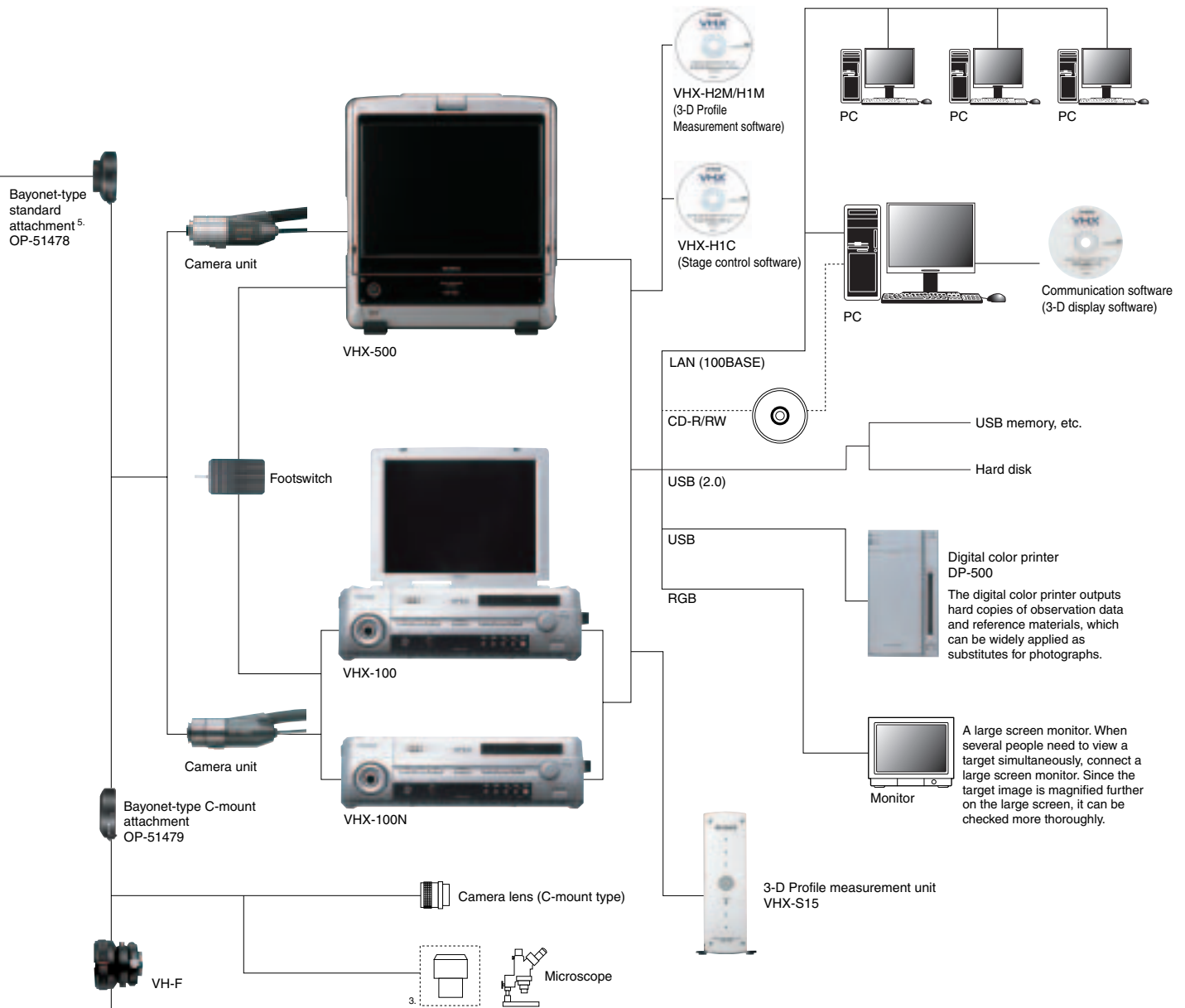

**FIBERSCOPE**

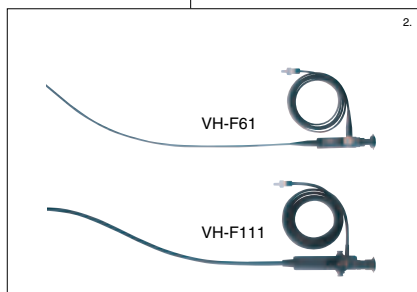

■ Option



1. The optional light guide dedicated to the VHX Series is required.
2. The optional light guide attachment dedicated to the VHX Series is required.
3. A C-mount adapter suitable for the microscope is required.
4. For coaxial illumination, OP-72407 and OP-72406 are required.
5. For the VH-Z100/Z450/Z500, OP-51647 is required.
6. OP-32348 is the special adapter for the VH-Z25.

Specifications (Basic function)

Model	VHX-500		VHX-100	VHX-100N <sup>3</sup>	
Camera	Image receiving element	1/1.8-inch, 2.11 million-pixel CCD image sensor		1/2-inch, 2.11 million-pixel CCD image sensor	
		Total pixels: 1688 (H) x 1248 (V)			
		Effective pixels: 1628 (H) x 1236 (V)		Effective pixels: 1636 (H) x 1236 (V)	
		Virtual pixels: 1600 (H) x 1200 (V)			
	Scan method		Progressive	Interlace	
	Frame rate		15 frames/sec. and 28 frames/sec. selectable		7.5 frames/sec. and 30 frames/sec. selectable
	Resolution	2 million pixels	1600 (H) x 1200 (V) Approx. 1000 TV lines		
		4 million pixel equivalent	1600 (H) x 1200 (V) Approx. 1200 TV lines		
		2 million pixels x 3 CCD mode	1600 (H) x 1200 (V) Approx. 1200 TV lines ( )	-	
		8 million pixels	3200 (H) x 2400 (V) Approx. 1600 TV lines		
		18 million pixels	4800 (H) x 3600 (V) Approx. 2000 TV lines or more		
	Gain		AUTO,NORMAL,PRESET		AUTO, NORMAL, MANUAL
	Electronic shutter		AUTO, MANU, 1/15, 1/30, 1/60, 1/120, 1/250, 1/500, 1/1000, 1/2000, 1/5000		AUTO, MANU, OFF, 1/15, 1/30, 1/60, 1/120, 1/250, 1/500, 1/1000, 1/2000, 1/5000
Supercharge shutter		0.2 sec. to 17 sec. Can be set in increments of 0.1 sec.			
White balance		Auto, Manual, One-push set, Preset (2700K, 3200K, 5600K, 9000K)			
Back-focus adjustment		Not required		-	
LCD monitor <sup>2</sup>	Size	Color LCD (TFT) 15"			
	Panel size	11.99" (H) x 8.99" (V) 304.5 (H) x 228.4 (V) mm	12" (H) x 9" (V) 304.8 (H) x 228.6 (V) mm		
	Pixel pitch	0.008" (H) x 0.008" (V) 0.1905 (H) x 0.1905 (V) mm			
	Number of pixels	1600 (H) x 1200 (V) (UXGA)			
	Scan frequency	-	75 kHz (H), 60 Hz (V)		
	Display color	Approx. 16,770,000 colors <sup>1</sup>			
	Brightness	200 cd/m <sup>2</sup> (typical)			
	Contrast ratio	500 : 1 (typ)	400: 1 (typical)		
Viewing angle	±85° (typical, horizontal), ±85° (typical, vertical)				
CD-R/ CD-RW drive unit	Speed	24x Write, 10x Re-write, 24x Read			
	Used disk	CD-R/CD-RW			
	Storage capacity	700 MB, approx. 3500 images (When a 2 million-pixel image is compressed) to approx. 117 images (When a 2 million-pixel image is not compressed)			
Hard disk drive unit	Storage capacity	160 GB (including 45 GB reservation area), approx. 575,000 images (When a 2 million-pixel image is compressed) to approx. 19,000 images (When a 2 million-pixel image is not compressed)	40 GB, approx. 200,000 images (When a 2 million-pixel image is compressed) to approx. 6667 images (When a 2 million-pixel image is not compressed)		
Image format		JPEG (With compression), TIFF (No compression)			
Light source	Lamp	12 V, 100 W, Halogen lamp		12 V, 100 W, Halogen lamp (OP-91641)	
	Lamp life	1000 hours (average)			
	Color temperature	3100 K (at maximum light intensity)			
Output	Video output		Analog RGB (1600 x 1200 pixels)		
	Scanning frequency	Special LCD monitor	75 kHz (H), 60 Hz (V)		
	External monitor	75 kHz (H), 60 Hz (V)			
Input	Mouse input		MINI-DIN 6-pin connector (DOS/V-compatible PS/2 mouse)		
	Keyboard input		MINI-DIN 6-pin connector (DOS/V PS/2)		
	External remote input		Pause/ Recording, Non-voltage input (Contact/Noncontact)	Non-voltage input (Contact/Noncontact)	
Interface	LAN	RJ-45 (10BASE-T / 100BASE-TX / 1000BASE-T)		RJ-45 (10BASE-T)	
	USB2.0 Series A	4 types: Special printer port x 1, VHX-S15 port x 1, External storage connection port x 2		2 types: Special printer port x 1, External storage connection port x 1	
	USB2.0 Series B	-			PC connection port
Power supply	Power-supply voltage	100 to 240VAC, 50/60Hz		85 to 132 VAC, 170 to 265 VAC, 50/60 Hz	
	Current consumption	310VA		260 VA	
Environmental resistance	Ambient temperature	+5 to 40°C (41 to 104°F), No condensation			
	Relative humidity	35 to 80%, No condensation			
Weight	Controller	Approx. 11.9 kg		Controller: Approx. 13 kg (with LCD monitor), Approx. 11.5 kg (without LCD monitor), Camera unit: Approx. 0.85 kg	
	Camera unit	Camera : Approx. 250 g, Cable : Approx. 600 g All-in-one			
	Console	Approx. 250 g			
Dimensions (Excluding the projected areas)		15.04" (W) x 16.73" (H) x 6.38" (D) 382 x 425 x 162 mm	15.75" (W) x 5.12" (H) x 15.16" (D) 400 x 130 x 385 mm	15.75" (W) x 4.53" (H) x 15.16" (D) 400 x 115 x 385 mm	

1. Approximately 16,770,000 pixels are realized with the dithering processing of the display controller.

2. The LCD monitor provided in the VHX Series is based on extremely advanced technology. Rarely, an unit part (black spot) or lit part (bright spot) may exist on the monitor screen. However, this is not an indication of the LCD monitor being defective.

3. The VHX-100N model does not feature the integrated special LCD monitor.

4. The VHX-H2M and VHX-H1M are the software dedicated to the VHX-500 and VHX-100F (VHX-100FN), respectively.

Specifications (Various functions)

Model	VHX-500	VHX-100	VHX-100N
Various controller functions	Depth composition function	Real-time depth composition High-quality depth composition	Quick depth composition High-quality depth composition
	Hybrid D.F.D 3-D display function	Provided (Quick)	Provided
	3-D illumination simulation function	Provided	-
	3-D two-screen simultaneous comparison function	Provided (Combination/Comparison/Difference display mode)	-
	Saving a 3-D 360°-rotation image	Enabled (3-D 360°-rotating observation after saving an image)	
	Real-time digital zoom	1.0x to 10.0x (100 steps)	
	Optimal contrast function	Provided	-
	Halation eliminating function	Provided	-
	Noise eliminating function	Provided	-
	Supercharge shutter function	Provided	
	Edge enhancement function	Provided (200 steps) For a moving image	
	Wide range view function	Provided	
	Gamma correcting function	Provided	
	Camera-shake correcting function	Provided (For a moving image)	Provided
	Split function	Vertical split, Horizontal split, 4-part split	
	Moving image recording/reproducing function	28 frames/sec. max. Moving image size (800 x 600), Actual moving image size (800 x 480)	-
Timer recording function	Provided		
Measuring function	Automatic unit VHX-S15 control function	Provided	-
	High-resolution dimensional measurement function	Provided	
	Wide-visual-field automatic 2-point measurement	Provided	-
	Distance, angle, radius, area, etc.	Various functions are provided	
	Automatic count/measurement function	Provided (Enables distance/area measurement through brightness/color extraction)	
	Scale display	Various functions are provided	
	Automatic edge detection	Provided	
	Auto calibration	Full-auto (Numerical input is not required)	
3-D profile measurement	Provided (Enables height profile display along an arbitrary line on the 3-D screen)		
Measuring function (Optional function) <sup>4</sup>	3-D height color/scale display function	Provided (Enables X/Y/Z-axis height scale display and color bar display related to height)	
	2-point height difference measurement function	Provided	
	Auto-focus function	Provided	
	Cross-section profile measurement	Provided	-
	3-D volume measurement	Provided	-
	3-D plane distance measurement	Provided	-
	3-D plane angle measurement	Provided	-
Utility	Complete style covering "Observation", "Recording" and "Measurement"	All-in-one system that enables all operations for "Observation", "Recording" and "Measurement" without using a PC	
	Mail transmission function	Provided	
	Pop-up guide	Provided	
	Bayonet-type attachment	Provided	
	Keyboard entry	Enabled	
	Compatible with a foot switch	Enabled	
	Function guide	Provided	
Console/Front panel (One-touch operation)	Pause	Provided	
	Recording	Provided	
	Shutter speed adjustment	Provided	
	Supercharge shutter	Provided	
	One-touch 2x zoom	Provided	
	Depth composition function	Provided	
	Quick 3-D display function	Provided	-
	Frame rate switching	Provided (15 frame/sec. or 28 frame/sec.)	Provided (7.5frame/sec. or 30frame/sec.)
	Light shift function (Height difference enhancement)	Provided (Surjective/Bijjective/Lateral illumination)	
	e-preview mode	Provided (Automatically lists 4 types of image modes, allowing selection of the optimal image)	
	Camera-shake correcting function	Provided	-
	Optimal contrast function	Provided	-
	Halation eliminating function	Provided	-
Sensitivity quick adjustment dial	Shutter speed and camera gain can be adjusted with one trimmer		
Halogen lamp light intensity adjustment	Provided		
Accompanying software	PC communication software	Image data transfer between the VHX and PC can be performed easily. (LAN)	
	3-D reproduction software for the PC (Available free of charge)	The PC can reproduce a 3-D image saved in VHX. (Copy free)	

Analyzing capacities of SEMs and roughness meters are easily available,  
as if you are handling optical microscopes

Ultra-deep color 3-D profile measurement microscope  
VK-9500

- | Observation magnification: 200x to 18000x
- | High resolution and large depth of field comparable to SEMs
- | Z-axis measurement resolution: 10 nm
- | Abundant analyzing functions, including profile and roughness
- | Applicable to large-size samples
- | Provides an image combination function that enables wide-visual-field analysis

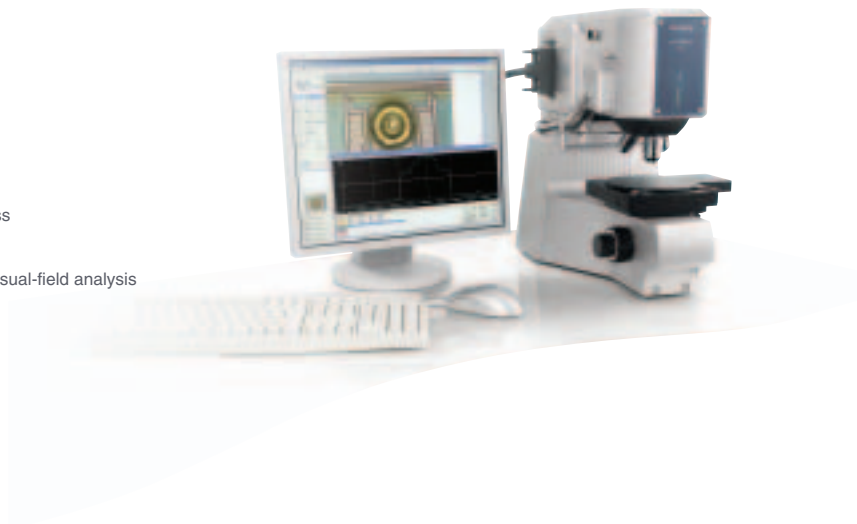

Total information site for microscopes  
You can check the latest functions in animation.

[www.digitalmicroscope.com](http://www.digitalmicroscope.com)

Specifications are subject to change without notice.

**KEYENCE**

CALL  
TOLL  
FREE

TO CONTACT YOUR LOCAL OFFICE  
**1-888-KEYENCE**  
1 - 8 8 8 - 5 3 9 - 3 6 2 3

[www.keyence.com](http://www.keyence.com)  
Fax : 201-930-0099

**KEYENCE CORPORATION OF AMERICA**

**Corporate Office** 50 Tice Blvd., Woodcliff Lake, NJ 07677 Phone:201-930-0100 Fax:201-930-0099 E-mail:keyence@keyence.com

■ Regional offices	<b>California</b>	N. California Los Angeles	<b>Illinois</b>	Chicago Indianapolis	<b>Michigan</b>	Detroit Grand Rapids	<b>New Jersey</b>	New Jersey Charlotte	<b>Oregon</b>	Portland Philadelphia	<b>Texas</b>	Dallas Richmond
	<b>Florida</b>	Tampa	<b>Kentucky</b>	Louisville	<b>Minnesota</b>	Minneapolis	<b>North Carolina</b>	Cincinnati	<b>Pennsylvania</b>	Nashville	<b>Virginia</b>	Seattle
	<b>Georgia</b>	Atlanta	<b>Massachusetts</b>	Boston	<b>Missouri</b>	St. Louis	<b>Ohio</b>	Cleveland	<b>Tennessee</b>	Knoxville	<b>Washington</b>	Seattle

**KEYENCE CANADA INC.**

1450 Meyerside Drive, #301, Mississauga, Ontario L5T 2N5 CANADA Phone:905-696-9970 Fax:905-696-8340 E-mail:keyence@keyence.com

KA1-0036