

TELEIOS

*heritage from
the original "direct print and heat-fixation"*

Stylish, Creative & Green Planet



TELEIOS GRANDE GS

3300mm print width



TELEIOS HEXA

1880mm print width

TAX Free
Import Tax-free FTA with
Korea and many countries
USA, EU, India
Indonesia, Colombia,
Peru, Turkey,
ASEAN, Philippines,
Vietnam, Malaysia
and more!!



Take-up unit
TU-4000 is optional

TELEIOS GRANDE/H6

3200mm print width

New Product!

TELEIOS

**expands your business,
boosts your profit.**

The world's most installed printer in the soft-signage market

- State-of-the-art patented textile feeding system provides an easy and excellent run-ability.
- Excellent printing on woven fabrics and low elastic fabrics used for back-lit, flag, banners, bedding and curtains.

High quality printing with awesome eye-catching colors

- Excellent penetration and a superb colorfastness. Your water Water-resistant flags will look great at both sides.
- Creates richer blacks than coal, and richer reds even than blood!

Now in 6 colors "the original direct fabric simultaneous printing and fixing printer"

- No other printer can still reach our colors and productivity in this class.
- Able to expand the color gamut and reproduce eye-catching colors like rich reds, deeper blacks, royal purples, fluorescent yellows and pinks.

Using digital pigment inks for home textile

- Teleios Grande G5 is the only 3.3m wide machine in the world that prints using pigment ink.
- Possible to relocate your production site to the urban area with waterless printing and digital textile pigment inks.

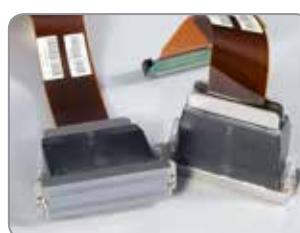

Ricoh's GEN5 print heads

Our printers are equipped with the most sophisticated print heads in the market offering an amazing high resolution of 600dpi with true grey scale.



HeatMAN

High speed heat-fixation for disperse dye ink and/or curing for pigment ink printings at a temperature between 80°C and 220°C and at a speed of 80 to 100 linear meters per hour.



patented textile feedingsystem

Allows an easy and a good run-ability printing on most woven fabrics used for back-lit, flag, banners, bedding and curtains.



5kg/color continuous ink supply system

Designed to be refilled with inks while printing. The level of ink is easy to check visually or by sensor. Is provided with a double filtering system able to protect the printer against any intrusive or harmful substances.

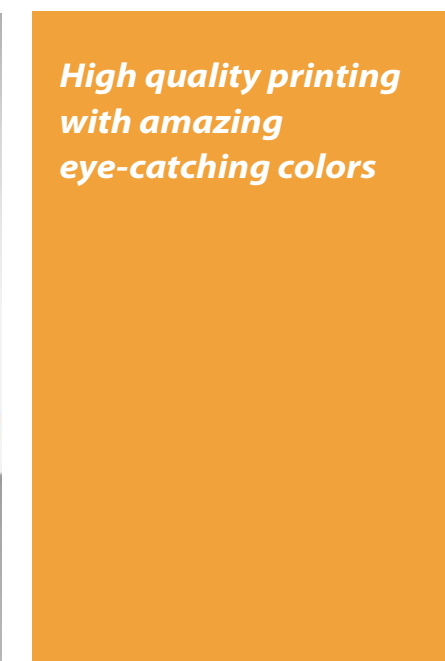
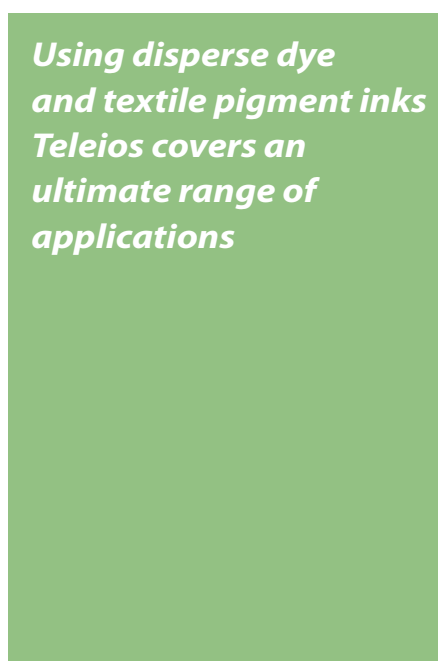
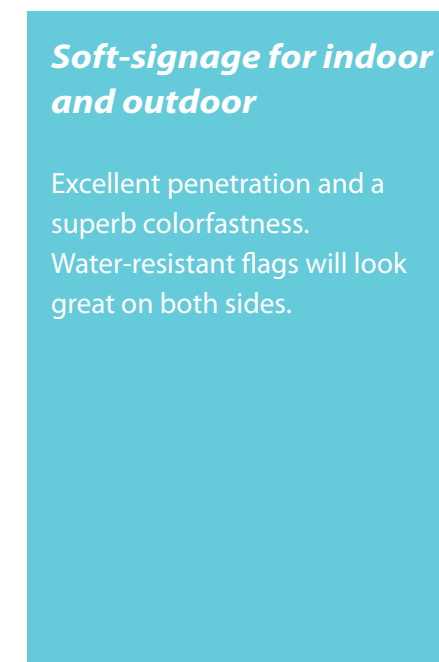
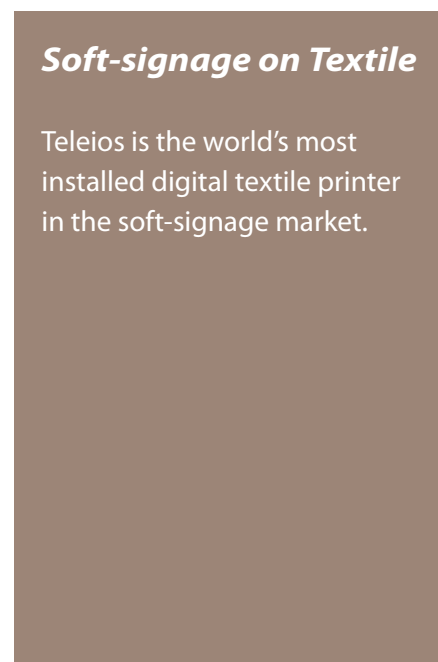

d.gen stands still one step ahead of its competitors

Teleios series specifications

TELEIOS GRANDE/H6



Maximum Printing width : 3,200 mm
 Printing Head : native 600 dpi, 7 pl/ dot, 8 level grey scale
 Maximum Resolution : 2400 dpi
 No. of colors : 6 colors
 No. of heads : 6 heads
 No. of nozzle / colors : 1280 nozzles/color
 Ink types : Disperse dye ink, Textile Pigment ink
 External shape : 5,021 (W) X 1,447 (D) X 1,516 (H) mm
 Power :
 Printer : 220V, 19A (4.2kw) + with Dryer
 Fixation : AC 380V, 3phase + N + PE, ±10%, 23A, 50/60Hz(15kw)
 Fume buster : AC 220 V, 3.4 A, 50/60 Hz

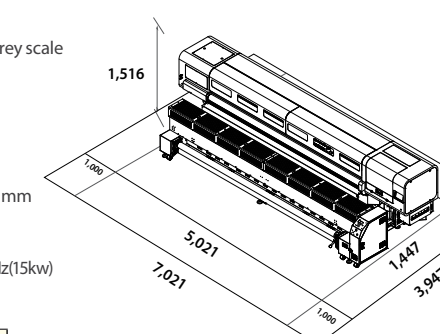

Target Printing Speed	600 dpi	142 m ² /h
	900 dpi	97 m ² /h
	1200 dpi	74 m ² /h
	1800 dpi	50 m ² /h

Speed: **177**m²/h by 600dpi width **3300**mm

setup space

TELEIOS GRANDE G5



Maximum Printing width : 3,300 mm
 Printing Head : native 600 dpi, 7 pl/ dot, 8 level grey scale
 Maximum Resolution : 2400 dpi
 No. of colors : 8 colors
 No. of heads : 8 heads
 No. of nozzle / colors : 2560 nozzles/color
 Ink types : Disperse dye ink, Textile Pigment ink
 External shape : 5,900 (W) X 1,130 (D) X 1,750 (H) mm
 Power :
 Printer : AC 380 V, 3 Phase + N+ PE, ±10%, 18 A, 50/60 Hz
 HeatMAN Grande : AC 380 V, 3 Phase + N+ PE, ±10%, 47 A, 50/60 Hz
 Fume buster : AC 220 V, 3.4 A, 50/60 Hz

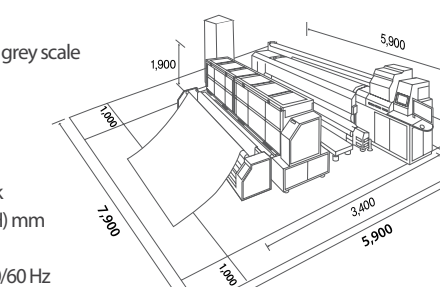

Target Printing Speed	600 dpi	300 m ² /h
	1200 dpi	154 m ² /h
	1800 dpi	119 m ² /h
	2400 dpi	90 m ² /h

Speed: **185**m²/h by 1200dpi width **3300**mm

setup space

TELEIOS HEXA



Maximum Printing width : 1,880 mm
 Printing Head : native 600 dpi, 7 pl/ dot, 8 level grey scale
 Maximum Resolution : 2400 dpi
 No. of colors : 6 colors
 Prin band width : 5.4 cm
 No. of nozzle / colors : 640 nozzles/color
 Ink types : disperse dye ink
 External shape : 3300(W) x 1500(D) x 950 (H) mm
 Power :
 Printer : 220V, 2A (0.44Kw)
 Fixation : AC 380V, 3phase (R+S+T+N+PE), 15A, 50/60Hz(9.87Kw)

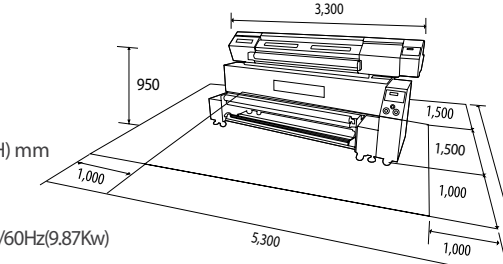

Target Printing Speed	600 dpi	72 m ² /h
	900 dpi	52 m ² /h
	1200 dpi	40 m ² /h
	1800 dpi	28 m ² /h

Speed: **72** m²/h by 600dpi width **1880**mm

setup space

*d.gen, Inc. may change the product and/or media specifications or accessories without any prior notice and has no liability for printing results in any case, d.gen, Inc. is not responsible for any incidental and/or inevitable damage from using this product.