



Type B Cake Donut Depositor

Designed for quality cake donuts. Also makes excellent hushpuppies, loukoumades, falafel, ball-shaped fritters, and more, depending on the mix or recipe used.

Description

Belshaw depositors, the industry standard for many years, are legendary for their precision and smoothness of operation - even after years of use in harsh conditions. Each depositor is engineered of durable gears, cams and trip arms that ensure identical volume and shape are produced with each and every deposit.

The Type B Depositor utilizes a hand crank to deposit at a rate up to 80 (or more) per minute. The internal workings of the Type B ensures a smooth turn of the crank handle and a regular deposit placed anywhere in the fryer. The service life of a Belshaw Type B is frequently measured in decades.

Standard features

(Apply to all models, unless otherwise specified)

- Aluminum alloy frame and arm assembly
- Hardened steel cams
- Bronze trip arms and bushings
- Aluminum hopper (Capacity 15 lbs/6.8 kg)
- Stainless steel and aluminum cutter unit
- Crank handle
- Compatible with Belshaw Type B/Type F plungers and cylinders only

Options

- Frame only (no hopper)

Accessories

- Type B Column Mount (#0405)
- Wall Mount (#0406)
- Bracket Arm Height Adjuster (#0400)

Plungers and Cylinders

- Available for rings, sticks, old fashions, crullers, krinkles and more. For selection see <http://www.belshaw-adamatic.com/products/doughnut-plungers/donut-plungers.html> Plungers and cylinders are purchased separately.

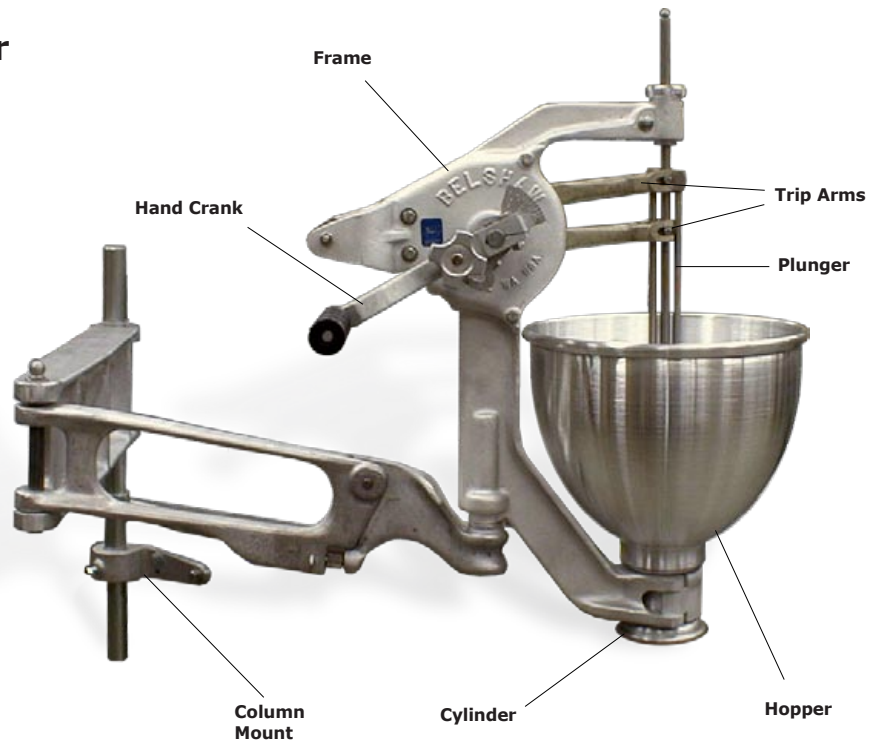

Belshaw Type B

(photo also shows optional plunger, cylinder, and column mount)

Shipping data

- Shipping weight: 44 lbs (20 kg)
- Carton size: 18 "x 21" x 26" (46 x 54 x 66 cm)
- Data is approximate for North America shipments
- Data does not include mounting system or plungers.

Electrical options

- No power required

Certifications



Certified by NSF (C2)

Diagram & Dimensions

(includes optional plunger, cylinder and mounting bracket)

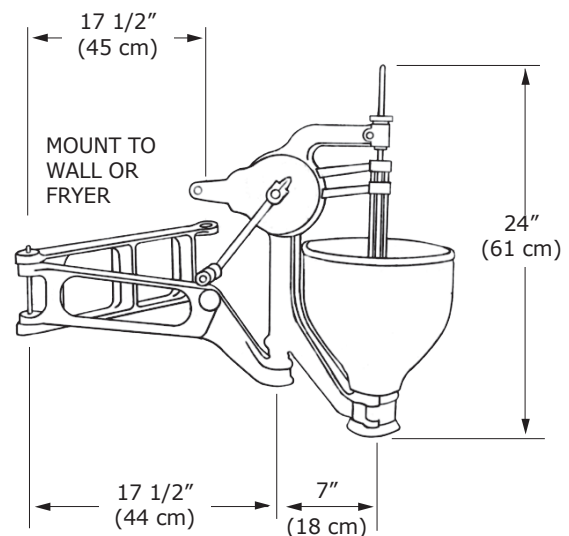

Model Selection

Item Nbr.	Description Key	Options
B0001000	B-LB-W/O	Standard Type B depositor (plunger/cylinder not included)
0226CHS	B-LB-W/O-X	Standard Type B depositor frame only (no hopper)

Description Keys: **B=Type B** **LB=No mounting bracket** **W/O=No plunger/cylinder** **X=no hopper**

Note: Other variations may be available on a made-to-order schedule. Contact info@belshaw-adamatic.com

Accessories

Item Nbr.	Description Key	Description
0405	B COLUMN MT BRKT KIT	Column mount bracket kit, Type B
0406	WALL MT BRKT KIT	Wall mount bracket kit, Type B or F
0400	HEIGHT ADJ KIT	Bracket Arm Height Adjuster. Enables quick accurate adjustment to height of depositor
0035SSAx[size]	CYL ASSY SS [size]	Cylinder for sizes up to 1-3/4" [insert size in inches]. Example: 0035SSAx1-3/4
0035SSBx[size]	CYL ASSY SS [size]	Cylinder for sizes larger than 1-3/4" [insert size in inches]. Example: 0035SSBx2

Replacement Items

Item Nbr.	Description Key	Description
0290	HOPPER B/F	Hopper for Type B / Type F

Plungers

Select from plunger selection page: <http://www.belshaw-adamatic.com/products/doughnut-plungers/donut-plungers.html>

Each plunger must match a cylinder of the same size. Different variety plungers may be used with just one cylinder, provided all are the same size. For instance, a 1-3/4" plunger can only be used with a 1-3/4" cylinder.



ACCESSORIES FOR TYPE B and TYPE F DEPOSITORS



Column Mount Bracket Kit

Supports Type B or F cake donut depositors, with precision screw for adjusting the angle of the depositor. Can be mounted on either side of any fryer that will accept the large rectangular Bracket Plate. The Bracket Plate is supplied standard with Belshaw fryers, otherwise purchased separately. Fryer must be bolted to the floor. Maximum extension 42"/105cm from column to donut drop.

Item Nbr #0405 (for Type B),
Item Nbr #0405F (for Type F)
Item Nbr #P-0002 (Bracket Plate, for non-Belshaw fryers)

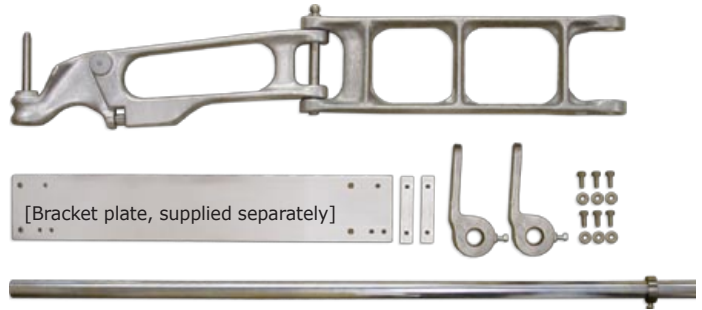

Wall Mount Bracket Kit

Supports Type B or F cake donut depositors, with precision screw for adjusting the angle of the depositor. Mounts to the wall behind or alongside fryer. Maximum extension 42"/105cm from wall to donut drop.

Item Nbr #0406 (for Type B and Type F)



Bracket Arm Height Adjuster

Precisely adjusts height of depositor. Features fast and accurate turn screw adjustment. This is an alternative to the standard Set Collar supplied with Belshaw Column or Wall Bracket kits.

Item Nbr #0400 (Height adjuster)



Hopper

Aluminum hopper for Type B and Type F. Capacity 15 lbs (6.8 kg). Accepts Belshaw Cylinders into bottom opening.

Item Nbr #0290







Plungers and Cylinders

A variety of plungers and cylinders are available for Type B and F depositors. (See <http://www.belshaw-adamatic.com/products/doughnut-plungers/donut-plungers.html>)



PLUNGERS AND CYLINDERS FOR TYPE B AND F DEPOSITORS

Item Number	Plunger variety	Photo	Donut type
<p>7SSx[size] [size]=1-1/2, 1-5/8, 1-3/4, 1-7/8, 2 Example: 7SSx1-1/2 Size = diameter in inches</p>	<p>Plain Plunger Used for plain ring donuts (using standard cake donut mix) or for old fashion donuts (using old fashion mix).</p>		
<p>7SC-SSx[size] [size]=1-1/2, 1-5/8, 1-3/4, 1-7/8, 2 Example: 7SC-SSx1-1/2 Size = diameter in inches</p>	<p>Star Plunger The Star plunger typically makes a ring donut with a more consistent, rounder hole than the plain plunger, with a star pattern around it.</p>		
<p>7B-1009x[size] [size]=1-1/2, 1-5/8, 1-3/4, 1-7/8, 2 Example: 7B-1009x1-7/8 Size = diameter in inches</p>	<p>French Cruller Plunger French Cake Plunger Use with French Cruller mix to make French Crullers. You can also make a 'French Cake' donut that is made with standard cake donut mix and looks similar, but without the eggy flavor.</p>		
<p>7F-1004x[size] [size]=1-1/2, 1-5/8, 1-3/4, 1-7/8, 2 Example: 7B-1004x2 Size = diameter in inches</p>	<p>Krinkle Plunger In the right hands this can be the most attractive of all the cake donuts. Features eight distinctive ball shaped sections.</p>		
<p>7G-1000-[code] [code]=4 digit code for diameter, number of holes, and size of holes Example: 7G-1000-082D Ball plungers are made to order. Contact Belshaw when ordering</p>	<p>Ball Plunger (2,3,4 or 5 Holes) Produces ball shaped donuts or 'donut holes'. With a compatible mix recipe, can also make other products such as hushpuppies, loukoumades, falafel, even fish balls.</p>		
<p>7H-1000-[code] (makes 1) 7H-1001-[code] (makes 2) [code]=4 digit code for diameter, height and length of slot Example: 7H-1001-102AE Stick plungers are made to order. Contact Belshaw when ordering</p>	<p>Stick Plunger (1 or 2 Slots) Makes stick donuts with 1 or 2 slots. The size of the donut will depend on the size of the slot and on the dial setting of the depositor. (Setting 1 will be short, setting 2 or 3 will be longer)</p>		
<p>7-1025x1-3/4 [size]=1-3/4 only Size = diameter in inches</p>	<p>Dunkerette Plunger Plain plunger with a divider that forms 3 deposits, each approximately one third of a ring donut</p>		
<p>35SSAx[size A] 35SSBx[size B] [size A]=1-1/2, 1-5/8, 1-3/4 [size B]=1-7/8, 2 Example: 35SSAx1-3/4 Example: 35SSBx2 Size = diameter in inches</p>	<p>Cylinder for Type B/F Plunger size and cylinder size must always match. For example, a 1-3/4" plunger must always be used with a 1-3/4" cylinder. However, you can use any variety of 1-3/4" plunger with a cylinder of the same size.</p>		