

# EDGETEQ S-240

**Serious entry-level class with strong features.**  
Perfect for reliable edge gluing.





# Perfect edges produced with flexible machines for demanding customers

Individual customer requirements, sophisticated products and a wide range of materials — these are all factors that play a key role in today's wood processing sector. Therefore, it is important that production is flexible and efficient, especially in woodworking shops and for medium-sized businesses.

HOMAG offers you unbeatable advantages, has an international production network as well as sales and service companies, with a presence in more than 100 countries and around 7000 employees. HOMAG can help make your business competitive and ensure lasting business success. In short:

## YOUR SOLUTION

[MORE AT HOMAG.COM](https://www.homag.com)

---



## CONTENTS

- 04 The most important features
- 05 Edge parameters
- 08 Models
- 12 powerTouch/easyTouch control systems
- 14 Apps and digital assistants
- 15 Our unit modules
- 30 Technical data
- 32 LOOPTEQ return
- 34 Life Cycle Services

## Five models plus extensions — the choice is yours

### THE MOST IMPORTANT FEATURES

The extensive equipment makes this series stand out: for example, PUR top roll pressure rollers for precise workpiece guiding, as well as optimized trimming tools for optimum chip removal and perfect processing quality. In addition, all machines can be extended. For example, units can be replaced on defined machines.

Machines in the EDGETEQ S-240 series are energy efficient and environmentally friendly.

- **High-quality furniture with high-quality edges**
- **More output due to high availability**
- **Low energy requirements**
- **High levels of efficiency**
- **Optimum price/performance ratio**



**Chain track in hardened design**



**Gluing units for safe hot-melt glue application**

HOMAG gluing units are ideal for quick, solid gluing. The heated gluing roller ensures an optimal adhesive temperature.



**Edge gluing with PUR**

At HOMAG, PUR glues are processed on the same machines and with the same application unit as EVA hot-melt glues.

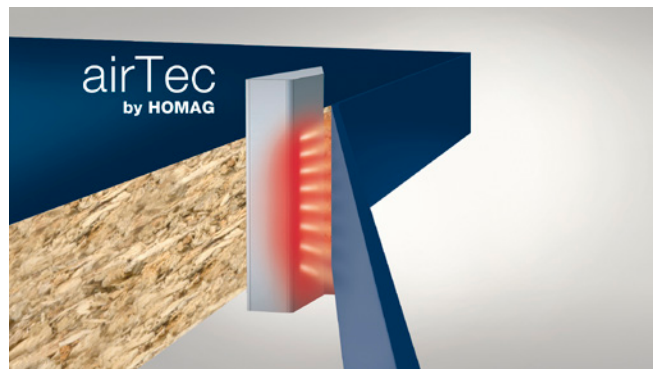

**Zero joint technology with HOMAG airTec**

Simple integration into the magazine in addition to the classic adhesive application with gluing roller.

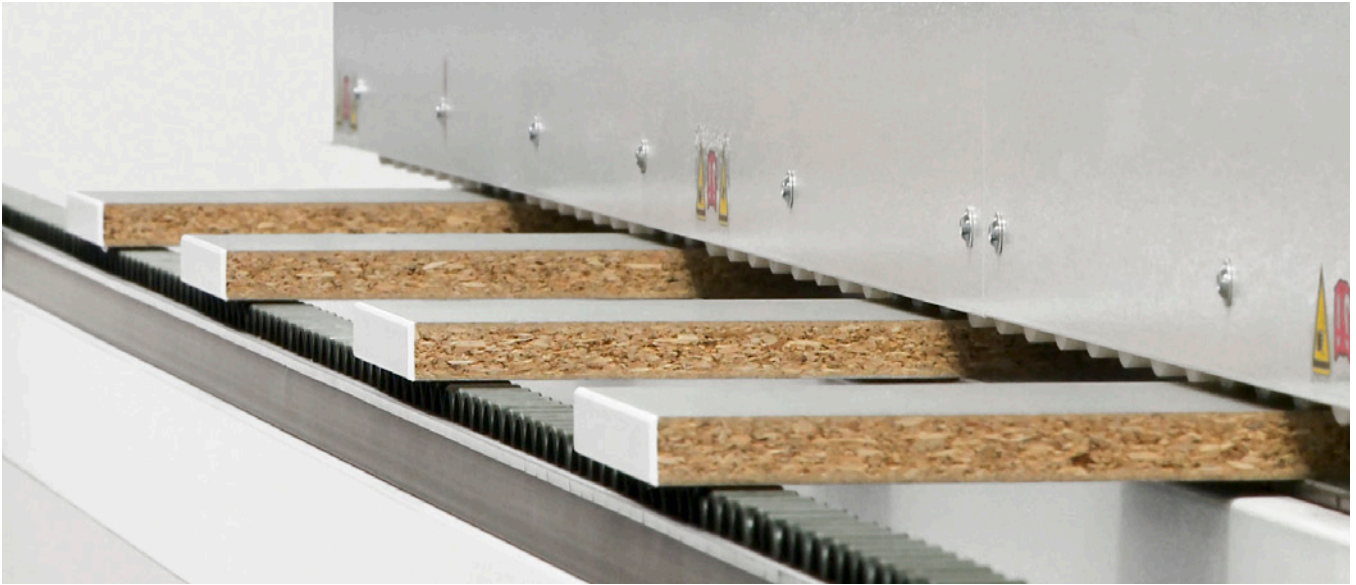

## Material types | Edge parameters

A high level of flexibility is achieved through the processing of all types of edge materials: 0.3-mm melamine, 2-mm ABS/PVC, 6-mm solid strip and veneer. For perfect high-gloss parts, important components such as the automatic adjustment of the glue joint scrapers are used. Special tracing elements are ideal for processing sharp-angled or blunt-angled parts or parts with hinge holes.

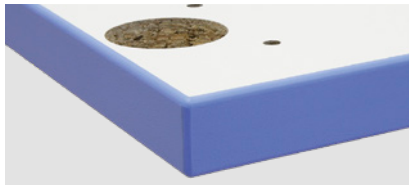
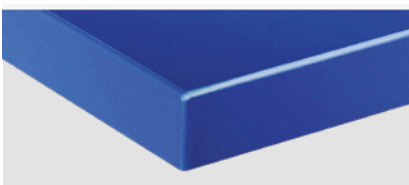
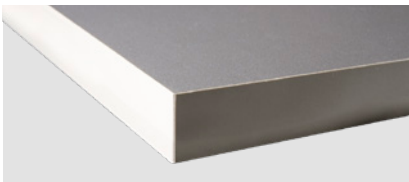

			a	b	c	d
	<b>SOLID</b> (mm)		If $b \leq 22$ : min. 70	8–60	0.4–3.0 (opt. 6.0)	65
	<b>ROLLERS</b> (mm)				0.3–3.0	
	<b>STRIPS</b> (mm)				0.4–3.0	



# Our solution for your requirements

If you are new to mechanical edge processing, you have come to the right place. Intuitive operation, initial automation and flexibility in the equipment are the hallmarks of the compact edge banding machines of the EDGETEQ S-240 series.



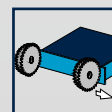
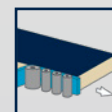

## EDGETEQ S-240 — 1230 FC model

The focus of the development was to enable complete processing in the entry-level segment, something which was previously only available in higher machine classes. The machine is equipped with a precise gluing station (e.g. for processing PUR granulate), a swiveling dual-motor snipping unit for straight cuts and chamfer cuts and a trimming unit. For complete processing, a joint trimming unit, a profile

trimming unit, a profile scraper, a glue joint scraper and a buffing unit are also available for the perfect finish. Alongside the machine's extensive unit equipment, automation of the units is also a possibility. Pneumatic adjustment of the snipper and pneumatic adjustment of the scraper are available in the standard version.

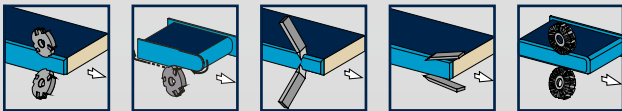
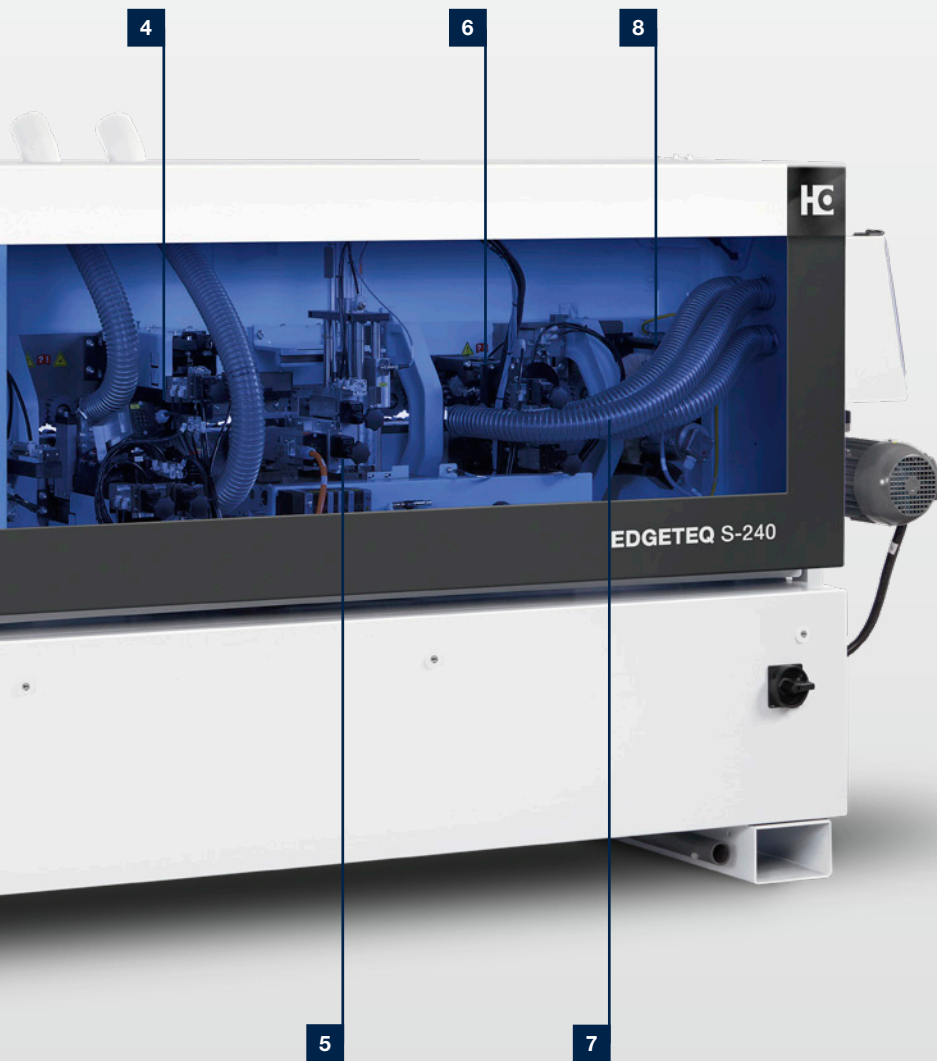

**1** Joint trimming unit

**2** Gluing unit

**3** Snipping unit

**5** Trimming unit

**5** Profile trimming unit

**6** Profile scraper

**7** Glue joint scraper

**8** Buffing unit

## EDGETEQ S-240 — 1230 HF model

### When the focus is on automation

The machine is equipped with a precise gluing station, a swiveling dual-motor snipping unit for straight cuts and chamfer cuts and a trimming unit. For complete processing, a joint trimming unit, a profile trimming unit, a radius scraper, a glue joint scraper and a buffing unit are also available for the perfect finish. The Highflex models of the EDGETEQ S-240 series are characterized by their high degree of automation and the extensive unit equipment. The high level of flexibility allows the machines to be aligned to your needs and guarantees optimal edges.



## EDGETEQ S-240 — 1240 FC model

### Greater flexibility thanks to the axis adjustment

Even in the basic version, this edge banding machine offers a high level of automation. The automation, for example, at the pressure zone, on the snipping unit, on the trimming unit and on the profile trimming unit results in a significantly simplified, time-saving setup process. Individual adjustments can be executed quickly and efficiently using the axis adjustments on the units.

For edge banding, the QA65N overhead glue application system with easy cleaning and emptying function is used. The special coating of the system means that all types of glue can be processed, including PUR.

In the finishing area, the optional multi-level scraper unit with two different profiles stands out. It can be fully operated and configured on an individual basis from the control system.





## powerTouch — The new dimension of machine control units

powerTouch represents the operating philosophy of HOMAG: standardized, simple, ergonomic and evolutionary. The innovative touchscreen operating concept combines design

and function in a completely new generation of control systems. 1240 FC model.

At the heart of the concept is a large, widescreen multi-touch monitor that allows machine functions to be controlled directly by touch. The entire programming interface is optimized for powerTouch operation and offers numerous help and assistant functions that make working processes substantially easier. Standardized control elements and software modules ensure that all HOMAG edge banding machines from the 1240 FC model can be operated in the same way using this new concept. They differ only in a few machine-specific details. This not only simplifies operating different machines, but also makes for greater efficiency by significantly reducing the time spent on training and service.

### The benefits

- **15.6" monitor with full HD resolution**
- **Quick overview of the machine status**
- **Easy, user-oriented navigation**
- **Guided path to production readiness using a traffic light indicator**
- **New ergonomic design of the operating panel**
- **Intuitive, natural operation of the machine**
- **Use of gestures, e.g. scrolling, swiping**



## easyTouch — Simple touches with effective results

The easyTouch control system embodies a new generation of operating systems. Simple touches on the touchscreen

interface guarantee fast navigation combined with ease of use.

### The benefits

- Clear 7" graphic display provides optimum control via touching the control panel directly
- 20 storable programs guarantee flexibility when processing a wide variety of edge materials and changing customer requirements
- Production readiness displayed by traffic light indicator
- Ability to adjust units quickly thanks to direct access via ctrl keys
- Intuitive, user-oriented navigation
- Clear overview of the help and assistant functions, including the glue pot temperature or troubleshooting in plain text
- The operating hours for each commission are recorded accurately thanks to state-of-the-art operating data acquisition



# Apps and digital assistants.

Quick and easy support in your machine environment.

Some people still use pen and paper to create their cutting patterns. But they look at their smartphone if they want to know what the weather is like – instead of looking out of the window. We asked ourselves: why not combine the best of both? Our apps and digital solutions make your everyday work easier: machines, material, tools, cutting patterns, components – you always have everything in your pocket or on your desk.



More information at [digital.homag.com](http://digital.homag.com)

## WE HAVE DEVELOPED POWERFUL AND SMART SOLUTIONS FOR YOU:

- ✓ Always low investment
- ✓ Always up to date (no updates necessary)
- ✓ Always easy to use (no complex software)
- ✓ Always helpful

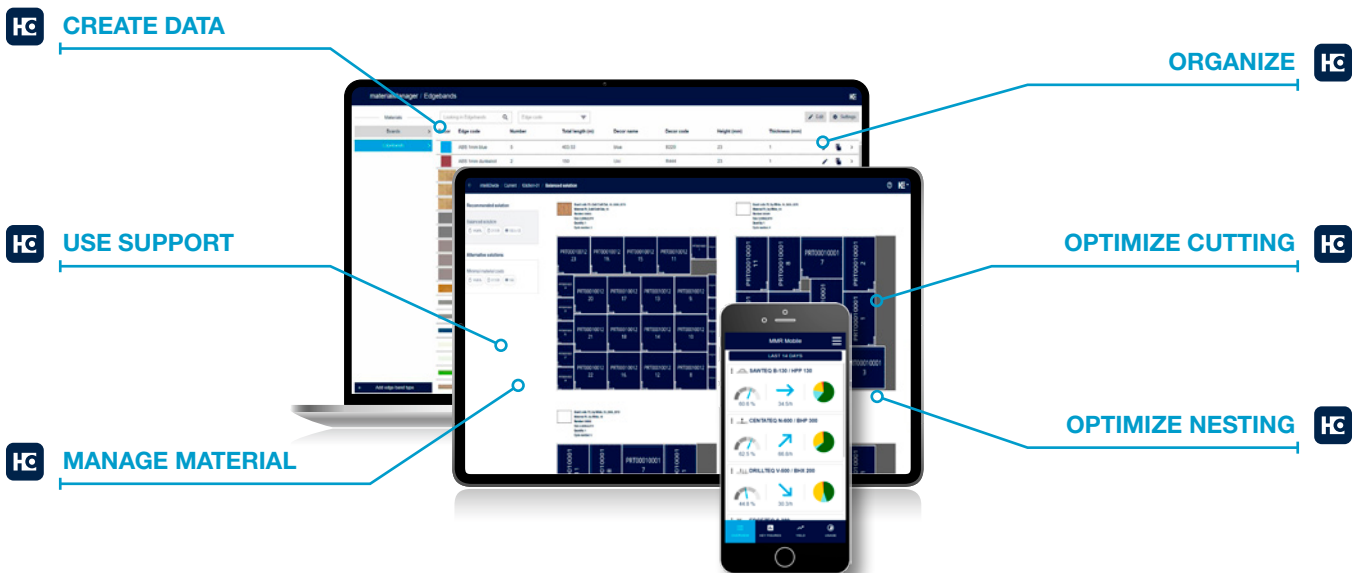

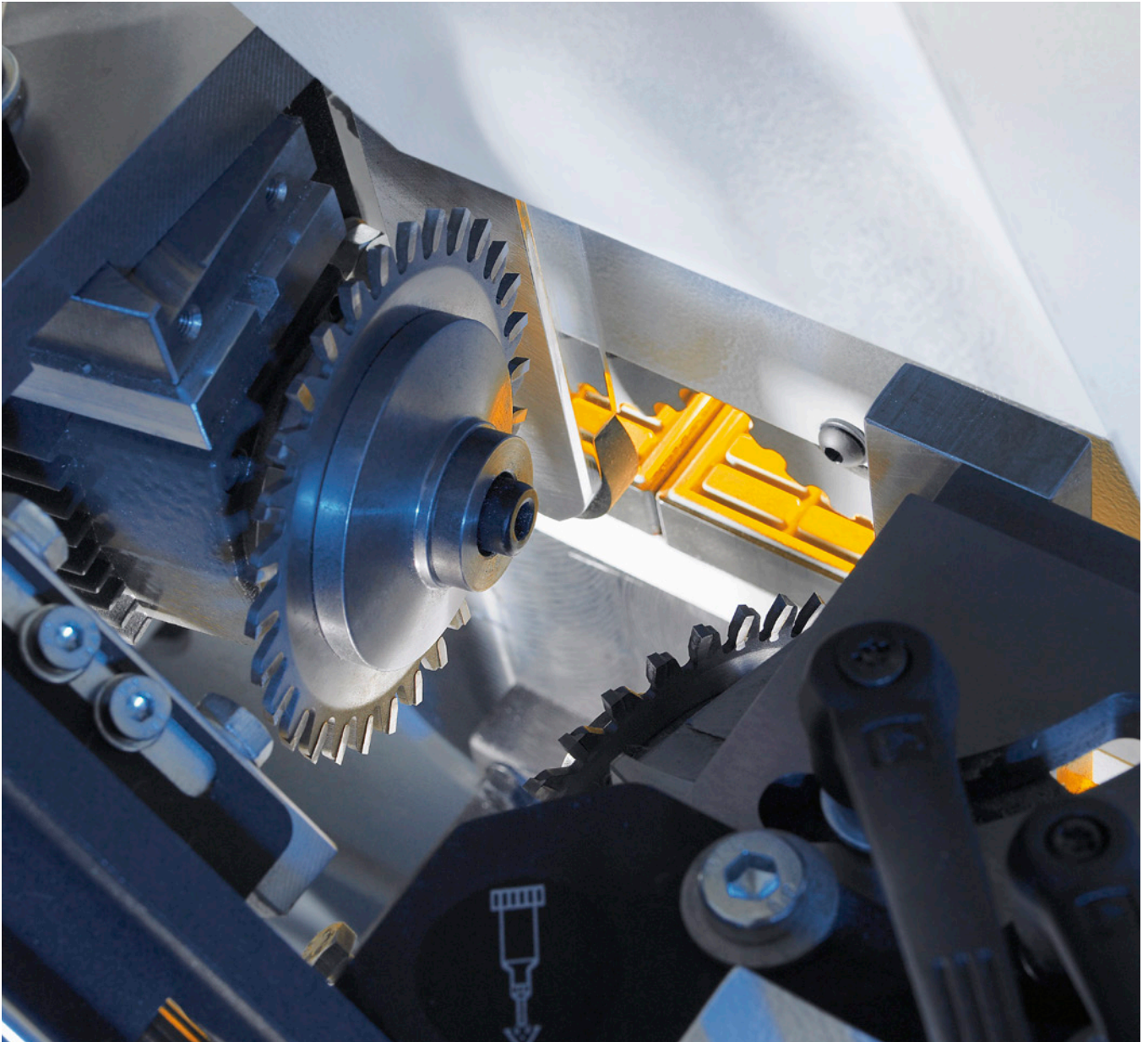

## Our unit modules: The right solution, whatever the requirement

For wide-ranging and diverse processing tasks, we use units from our tried-and-tested unit modules. We are constantly expanding our functions so we can offer you the right solution for new trends. The following pages contain units from the

fields of joint trimming, gluing, cutting, profile trimming and finishing. You benefit from a high level of precision and state-of-the-art technology, and the ability to produce your products flexibly and efficiently.

## Sprayers

Sprayers improve the edge quality throughout processing. Separating agents prevent hot-melt glue residues forming deposits and anti-static agents prevent plastic chips forming

deposits. The adhesive residues can be easily removed using cleaning spray. Lubricants prevent shiny marks on the workpieces and protect sensitive surfaces before trimming.

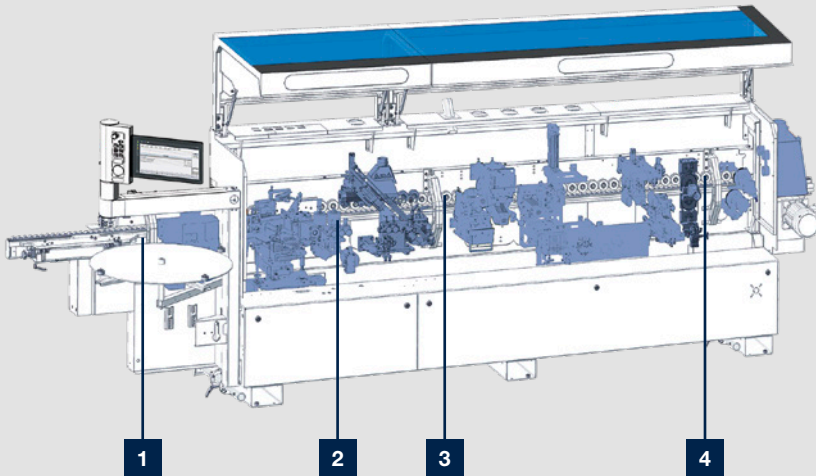

- 1** Separating agent
- 2** Lubricant
- 3** Anti-static agent
- 4** Cleaning agent

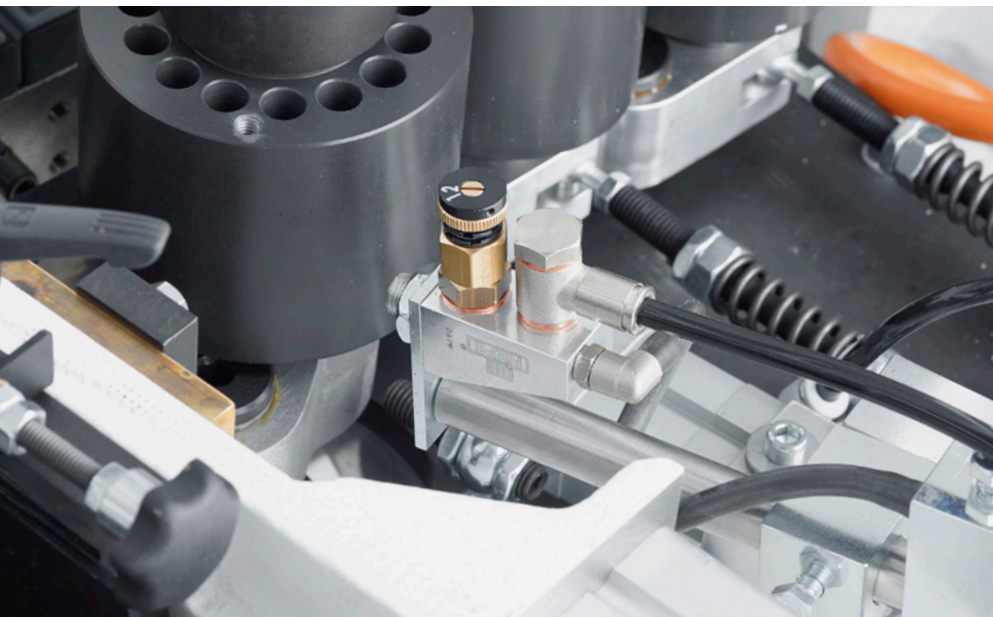

### **Spraying device**

Spraying agents for optimal processing results, even for sensitive surfaces.

## Workpiece feeding

Workpieces need to be fed into machines precisely in order to achieve perfect edge quality. Take advantage of the benefits our solutions have to offer, such as infeed guides, sliding carriages and automatic edge infeed.



### Automatic adjustment of the infeed guide

Program-controlled, precise and repeatedly accurate adjustment of the infeed guide via the servo axis.

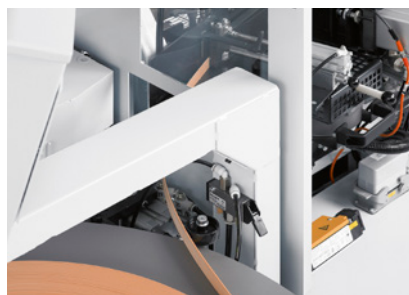

### Infeed device

Automatic edge infeed for quick edge changes between different rolls of material.

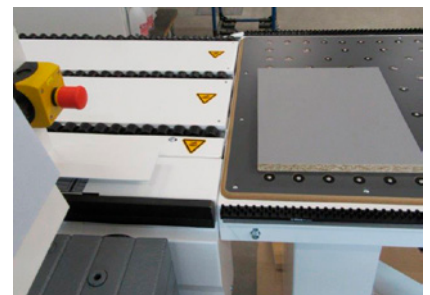

### Air cushion table at outfeed

Available in combination with the infeed table, size: 1275 x 650 mm  
From model 1240 FC

## Joint trimming unit

Our joint trimming unit forms the basis for precise, absolutely straight and tear-free workpiece edges and glue joints with

consistently high product quality.

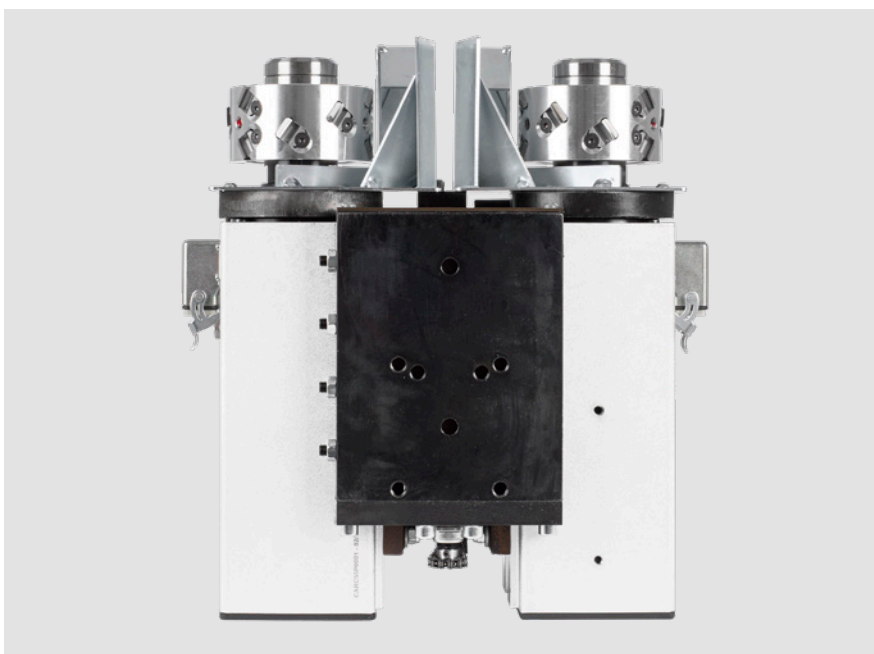

### Joint trimming unit

Diamond tools ensure perfect cutting and a long service life, as well as optimal glue joint quality. The diameter is 100 mm.

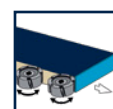

## Gluing units for safe hot-melt glue application

HOMAG gluing units are ideal for quick, solid gluing. The heated gluing roller ensures an optimal adhesive temperature.

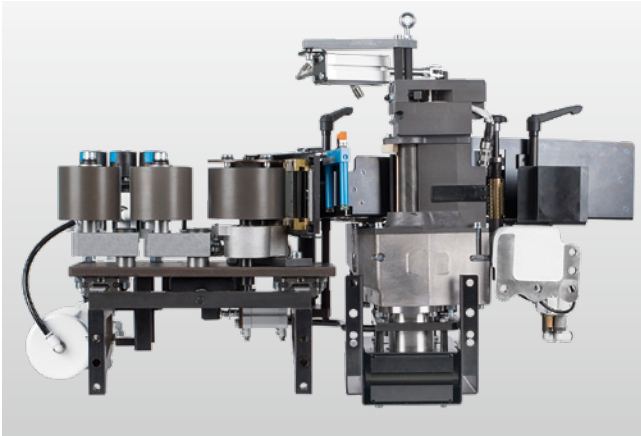

### Gluing units

Quick-change application unit with hot-melt glue supply from below.  
Can process PUR granulate.

### Your benefits at a glance:

- Optimal glue application to narrow surfaces
- Glue application roller does not need to be changed for different workpiece thicknesses
- Gluing roller lifts when feed stops
- Gluing roller with integrated heating unit guarantees a constant temperature and viscosity for all workpiece thicknesses
- Tracing pad prevents wear to the application roller and ensures a constant glue film thickness
- The application unit can be easily removed thanks to the quick-release lock

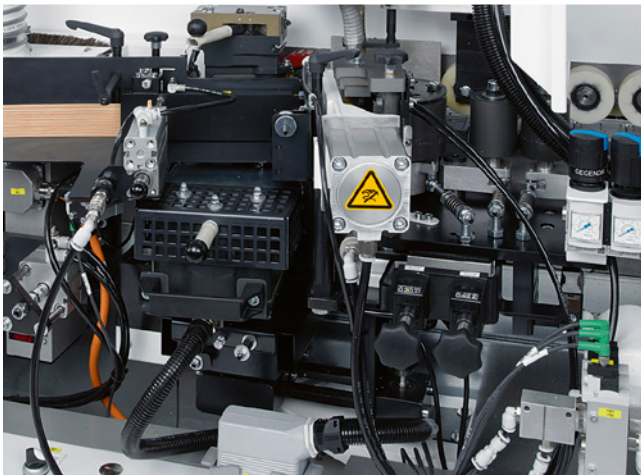

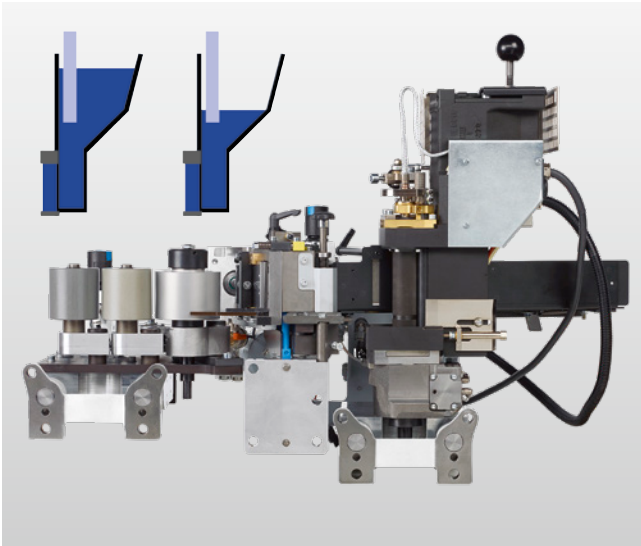

**Overhead gluing unit – QA65N glue application system**

The application unit can be easily removed by means of a quick-change device with pneumatic interface.  
For the 1230 HF, 1230 AT and 1240 FC models.

**Sensor for checking the fill level of the application unit**

Switching to a lower glue level guarantees a fast heat-up time for processing small batch sizes.

**Your benefits at a glance – QA65N**

- Short heat-up time thanks to sensor-controlled level regulation (two levels can be selected)
- The application unit can be easily removed by means of a quick-release lock for melting hot-melt glue either automatically or manually
- Gluing roller with integrated heating unit guarantees a constant temperature and viscosity for all workpiece thicknesses
- Electro-pneumatic clamping of the gluing roller and tank prevents glue contamination to the rear edge of the workpiece
- Tracing pad prevents wear to the application roller and ensures a constant glue film thickness
- Gluing roller lifts when feed stops

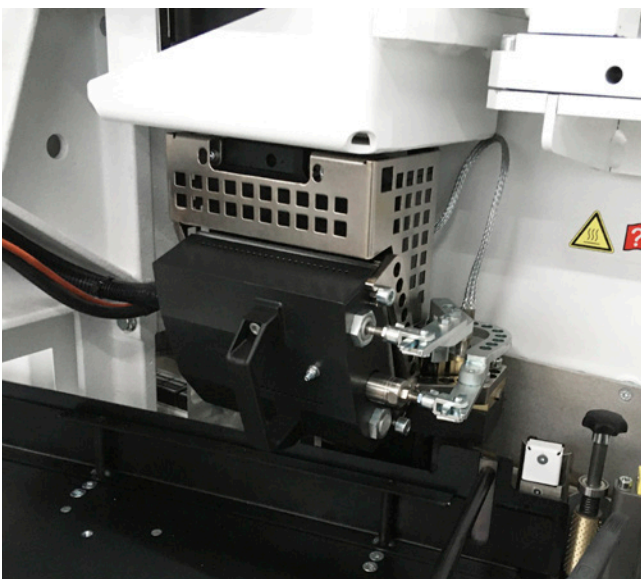

**Automatic glue quantity metering**

The application quantities are implemented quickly and easily via the powerTouch user interface for automatic glue quantity metering. The glue is applied in synchronous operation.

Precisely and quickly adjustable glue quantities result in:

- Optimal gluing quality
- Higher availability and performance
- Greater cost efficiency

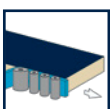

## PUR glue and HOMAG – a strong connection

Using polyurethane (PUR) hot-melt glue increases the resistance of furniture to moisture and heat. It is ideal for use on furniture in damp areas such as bathrooms, kitchens and laboratories.



### **Your HOMAG PUR benefits at a glance:**

- One application unit for all types of adhesive
- No additional application unit required
- Fast, powerful thin-film application by means of gluing roller with integrated heating unit
- To be used as standard from the entry-level model to the high-end machine



**Melting unit for PUR**

- Melting capacity up to 2.5 kg/h
- Temperature regulation to protect against overheating



**Vacuum container**

- Compact, portable container for the PUR application unit
- No vacuum pump and no nitrogen necessary



**Service station**

- Preheating and cleaning station for the QA65N application unit with one storage position
- High level of flexibility with up to two vacuum containers for one QA65N application unit or one PUR melting unit with 2.5 kg/h
- No vacuum pump and no nitrogen necessary
- With optional accessories also for application units for the powerEdge Pro/Pro Duo CNC edge banding unit

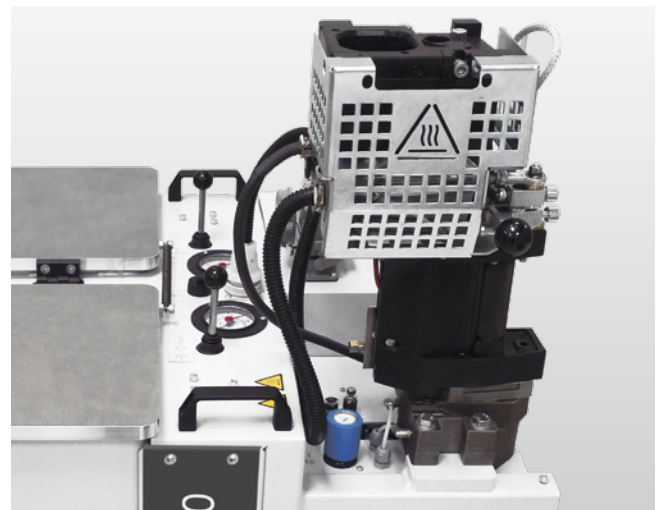

**Service station**

- The image shows the application unit in the holding device for preheating

## Systematic gluing

For solid gluing, it is crucial to achieve an optimum interplay of very different factors. At HOMAG, the workpiece preheating, application unit, quick-release system, magazine and pressure zone are perfectly aligned.



### Workpiece preheating with contact heating shoe

High-strength gluing due to optimum workpiece preheating.



### Melting unit in three versions:

#### EVA, PUR as well as EVA and PUR

- Efficient processing, as the adhesive is pre-melted
- Melting capacity max. 2.5–4 kg/h
- With the combination EVA and PUR, it is fast and easy to change the type without cleaning thanks to interchangeable containers



### Workpiece preheating with heaters

High-strength gluing due to optimum workpiece preheating. On the 1240 FC model.



### Interchangeable container

Easy to use for EVA and PUR adhesives

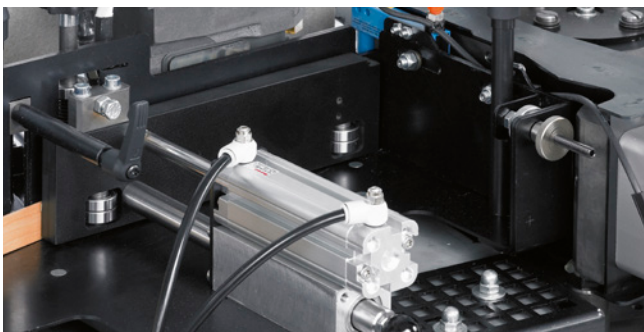

### Roller counter pressure

Roller counter pressure for sensitive edge material.



### Pressure zone

Heavy pressure zone up to an edge thickness of 3 mm and a panel height of 50 mm for optimum glue joint quality (optional: 6 mm edge thickness for 60 mm panel height).

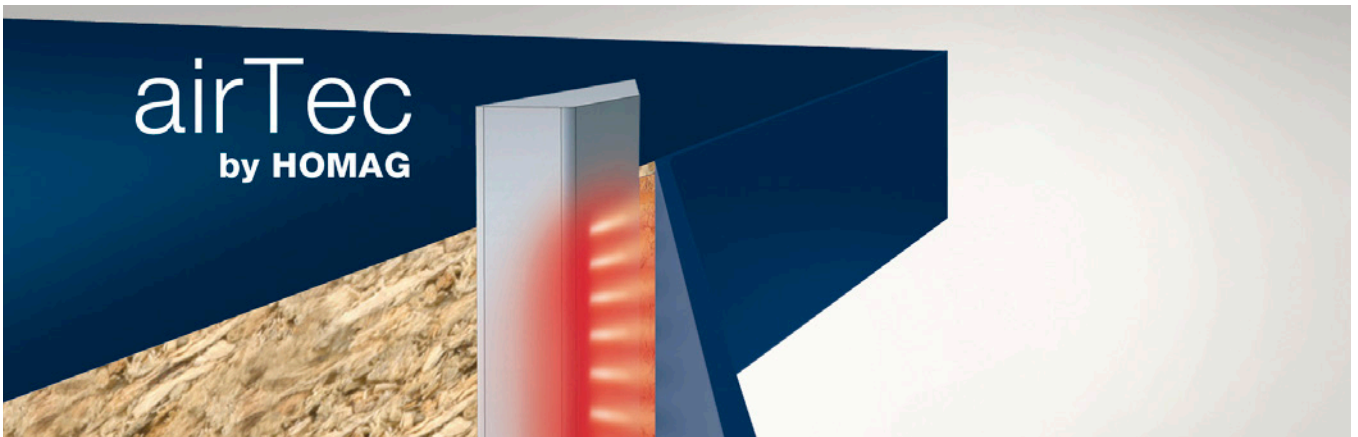

## airTec — an ideal introduction to zero joint technology

The airTec process has established itself as the optimum zero joint solution for woodworking shops and medium-sized companies. HOMAG's response to increases in demand is an innovative and more efficient airTec solution that ensures

a more cost-effective use of resources. All laser-compatible edging types that are currently available on the market can be processed with airTec. This means great flexibility for all materials and colors.



### Gluing edges "without joints"

In the airTec process, the edge and panel are bonded using hot air. This requires the use of special edges. These consist of a decorative layer and a functional layer. Using the HOMAG airTec unit, the functional layer is melted at a constant temperature and volume outflow and optimally applied to the narrow surface.

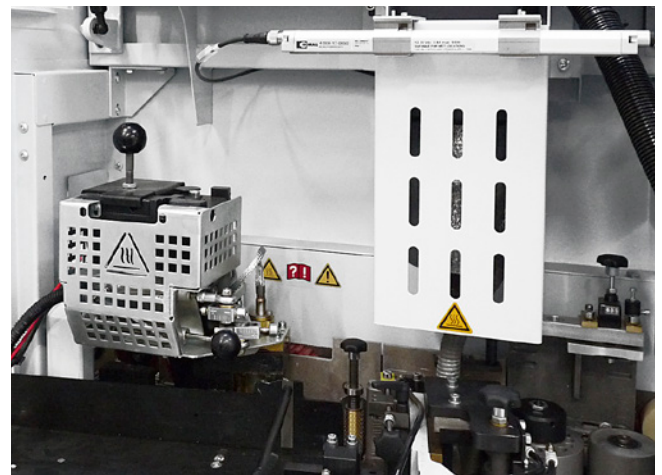

### Easy integration

The airTec reactivation unit is installed in such a way that you can work with either the standard application unit or the airTec system. Image: 1230 AT model.

## Snipping unit for cutting the overhangs on the front sides

The snipping unit prepares the workpieces for subsequent trimming perfectly. The front side can be snipped straight or with a chamfer.

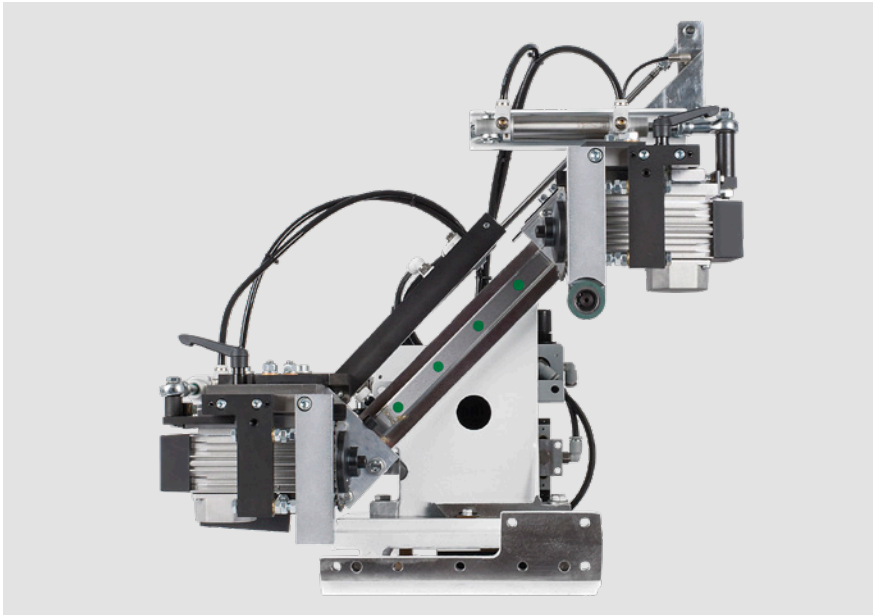

### Snipping unit

Exact snipping cut via a robust snipping unit with a highly precise linear guide. Swivels to easily adjust for chamfer or straight snipping (optional: adjustment via pneumatics).

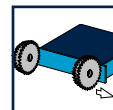

### Can be automated

For a quick change between flush snipping, e.g. of solid strips or shelves, and cutting with an overhang, e.g. for post-trimming with a profile trimming unit.

## Trimming units for flush trimming

Our fine-milling units offer the perfect solutions for processing edge overhangs. The trimming units are only equipped with tools that collect the chips in a controlled manner.



### Trimming unit

Trimming unit with DFC tool technology (dust flow control) for optimal extraction.

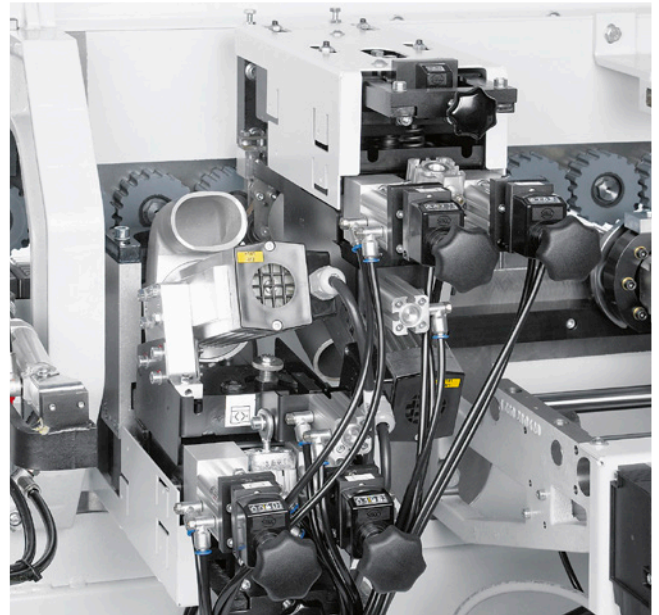

### Trimming unit with pneumatic three-point adjustment

For more efficient production and significant time savings during changeover.



# Profile trimming units

The profile trimming units are universal. As a user, you have the option to manually adjust the units or perform programming using the control system.

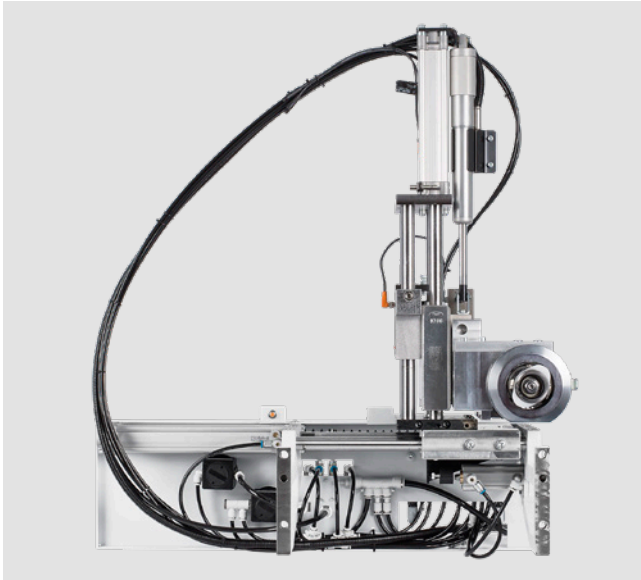

### FF 10 profile trimming unit

Optimum profile trimming without making adjustments thanks to linked DIA tool and detector roller. Equipped with automatic adjustment between thin and thick edges. Workpiece thickness 60 mm.

#### Can be automated

Automatic adjustment to two different profiles possible.

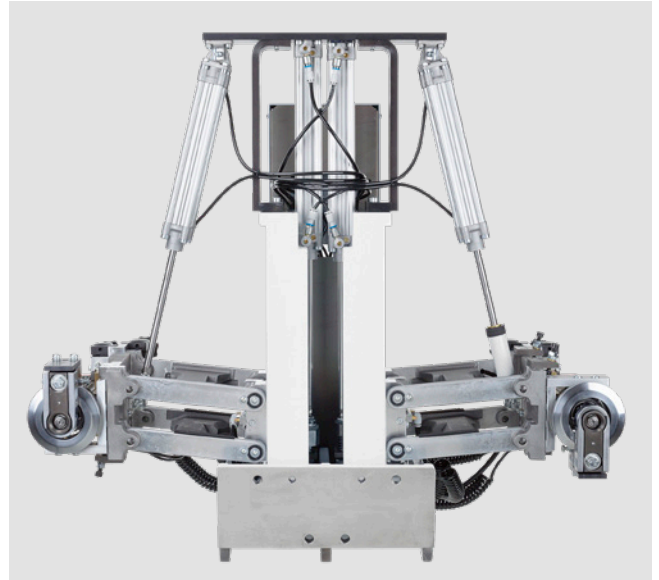
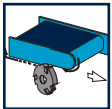

### FF 20 profile trimming unit

For rounding corners on thick PVC edges, as well as top edges on post-forming and soft-forming parts. Equipped with automatic adjustment between thin and thick edges. Workpiece thickness 60 mm. Optional for the 1240 FC model.

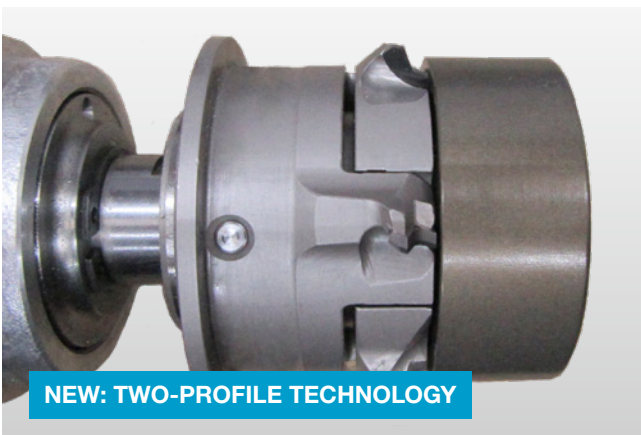
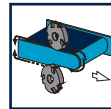

**NEW: TWO-PROFILE TECHNOLOGY**

### Automatic and exact changeover with FF10

The HOMAG two-profile technology can also be used to automatically change between two profiles and a chamfer. The axis adjustments allow a short setup time with perfect repeat accuracy.

#### Highlights of the new tool system

- Robust mechanics
- Closed system that can be easily maintained from the outside without being dismantled
- Sensory detection of the tool levels — for clear determination of the tool position
- Safe tool positioning thanks to special adjusting axes



**Structural shelves**

Profile trimming is also possible on workpiece sides without an edge. This applies not only to structural shelves, but also to upper and lower shelves, shelf inserts and partition panels.

## Finishing units

With optimally matched finishing units, HOMAG makes the quality of your products perfect.



### Profile scraper unit

Unit for smoothing radii and chamfers. Equipped with changer heads to allow rapid profile changes.

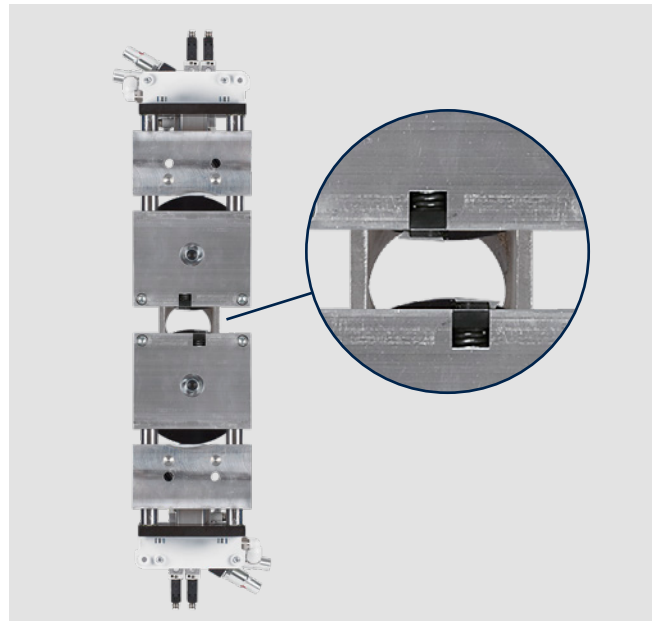
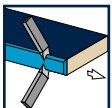

### Glue joint scraper unit

For the perfect finish.

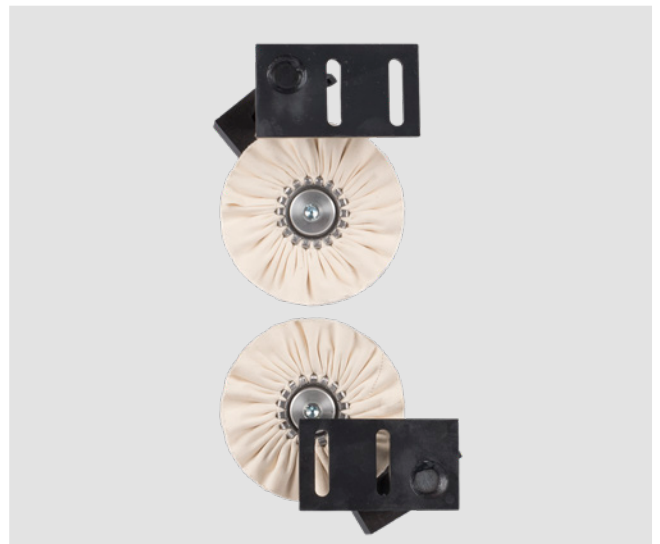
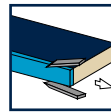

### Buffing unit

For polishing edges for a natural color.

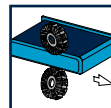

## Finish with multi-level technology

The range of edges and panel materials is continually growing and so is the demand for flexibility. It is immaterial if edges are made from plastic, solid wood or veneer, or if workpieces

have high-gloss surfaces. The multi-level scraper always offers the optimum radius for frequently changing applications, and therefore the best results.

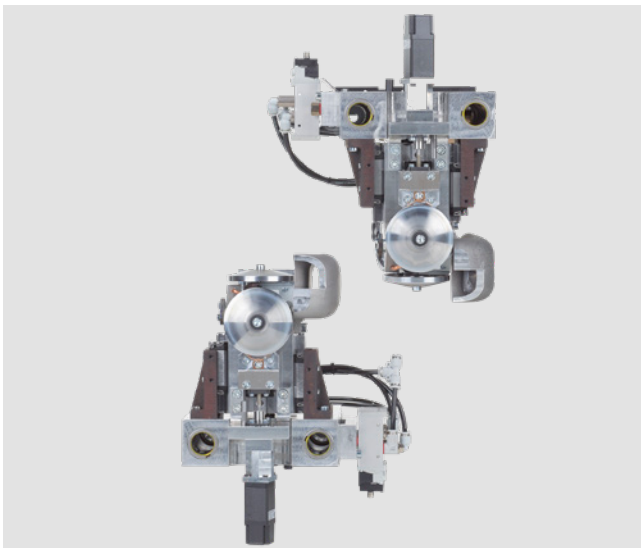

### Multi-level scraper unit MZ 40

Fully automatic changeover to two different profiles using servo motors\*.

On the 1240 FC model.

\* Servo motors: Servo drives consist of motors with an infinitely variable adjustment. They impress thanks to a high positioning accuracy and are particularly suitable for small positioning distances.

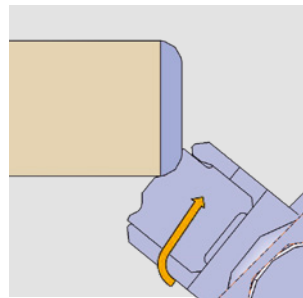

1. Profile 1

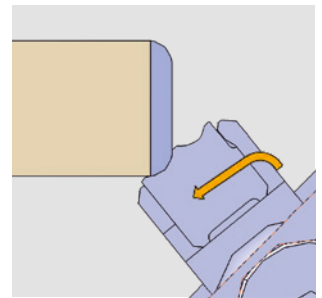

2. Profile 2

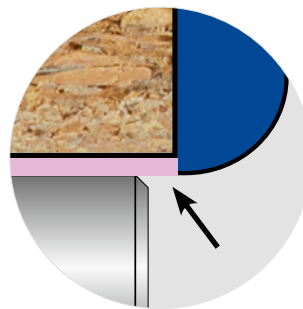

Optimum compensation for protective films

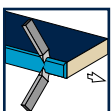

**TECHNICAL DATA OF THE EDGETEQ S-240 SERIES**

	Model 1220 FC	Model 1230 FC	Model 1240 FC	Model 1230 HF	Model 1230 AT
<b>Overall length (mm)</b>	4236	4740	5273	4740	5035
<b>Feed [m/min]</b>	11				8
<b>WORKING DIMENSIONS</b>					
<b>Workpiece width (mm) *</b> for workpiece thickness 8–22 mm			70		
<b>Workpiece thickness (mm)</b>	8–50 (opt. 8–60)		8–60		
<b>Edge thickness rollers (mm)</b>			0.3–3		
<b>Edge thickness strips/moldings (mm)</b>	0.4–3 (opt. 0.4–6)		0.4–6		

\* Dependent on the workpiece thickness

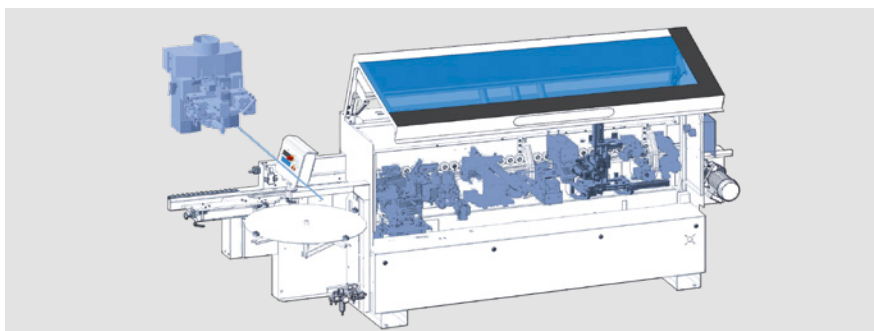
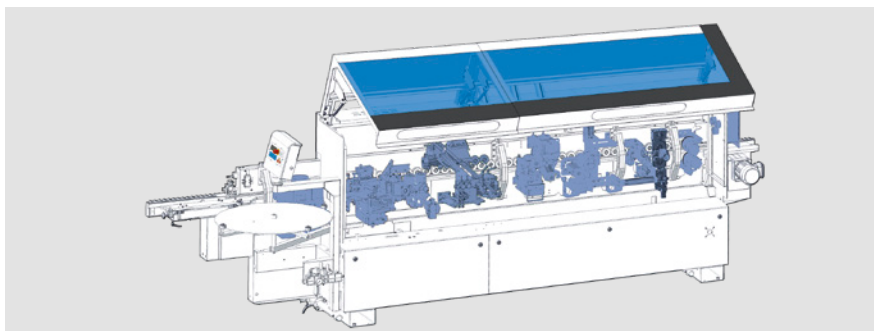
**Model 1220 FC****Model 1230 FC**

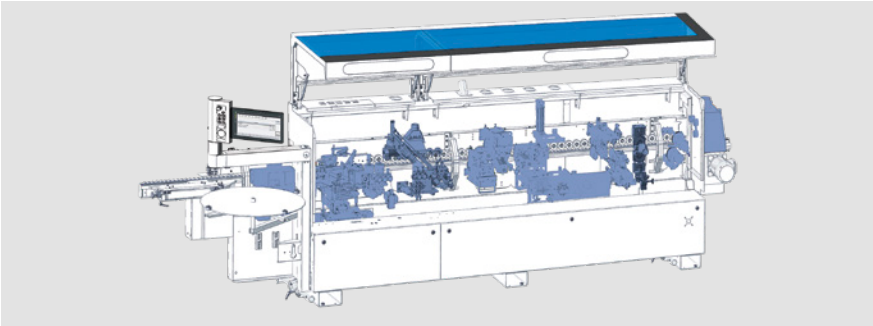

**Model 1240 FC**

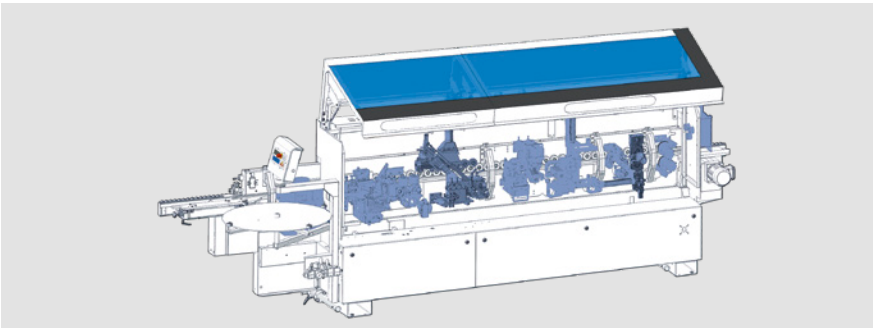

**Model 1230 HF**

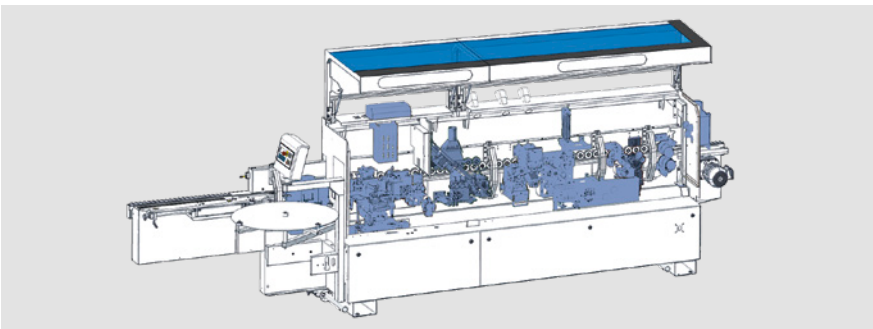

**Model 1230 AT**

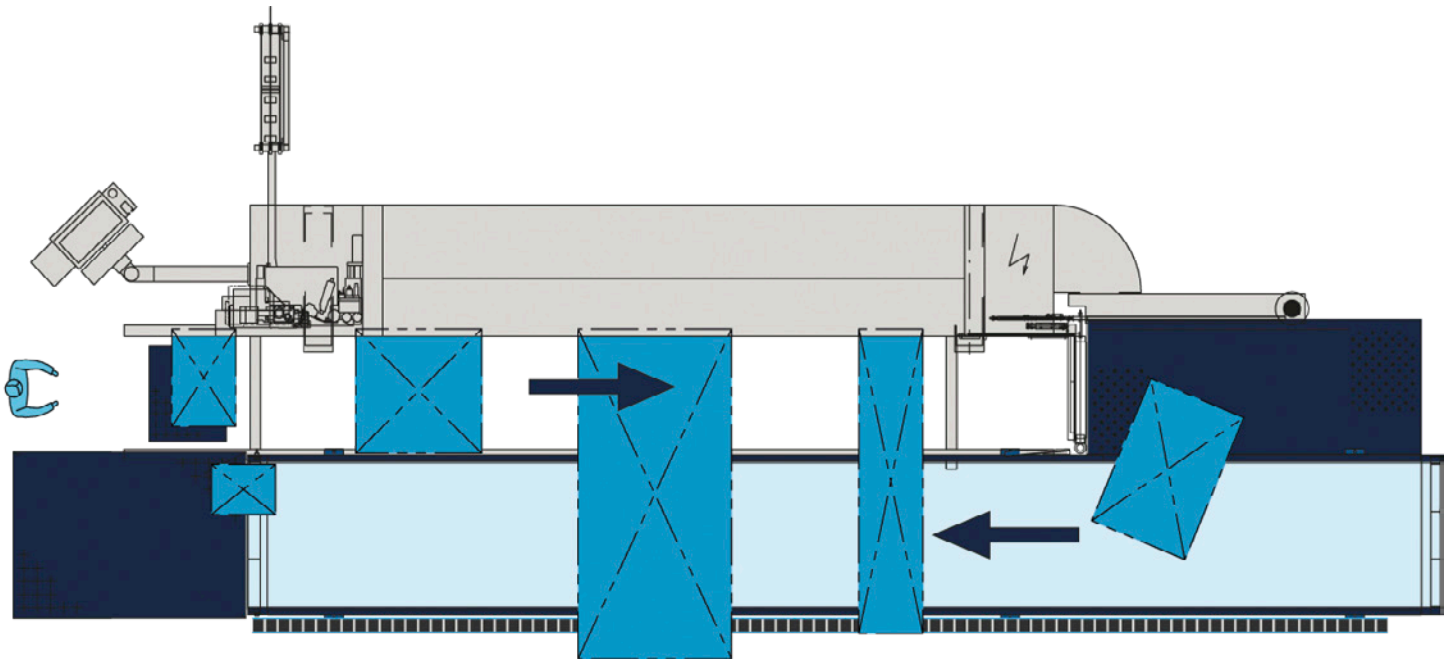

EDGETEQ S-500 with workpiece return LOOPTEQ

## LOOPTEQ O-200 and LOOPTEQ O-300 return: higher productivity for your HOMAG edge banding machine

This indispensable helper makes the return system of your HOMAG EDGETEQ even more efficient. One-person operation enables you to optimize your workpiece return flow, resulting in a streamlined and efficient production process. Your

HOMAG machine from the EDGETEQ S-240 series (from model 1240 FC) can be freely combined with this return. It is ideally suited for customers with small, narrow and medium-sized workpieces.

### Your benefits at a glance:

- **Fast return on investment — pays for itself from just nine hours of operating time per week**
- **Flexible personnel organization thanks to cost-effective single-person operation**
- **Ergonomic working — manual parts handling is reduced to a minimum**
- **Better quality control — quick response to material adjustments**

## Technical data

	LOOPTEQ O-200	LOOPTEQ O-300 TFU 140/20	LOOPTEQ O-300 TFU 140/25
Workpiece length (mm)	300 – 2500	300 – 2500	240 – 2700
Workpiece width (mm)	50 – 1450	60 – 800	60 – 1000
Workpiece thickness (mm)	8 – 60	8 – 60	8 – 60
<b>FOUR-SIDED PROCESSING*</b>			
Min. workpiece size (mm)	300 x 300	300 x 80	240 x 80
Max. workpiece size (mm)	1450 x 1450	2000 x 800	2500 x 1000
<b>MISCELLANEOUS</b>			
Workpiece weight (max. kg)	50	50	50
Surface weight (kg/m <sup>2</sup> )	25	25	25

\*In four-sided processing, larger parts can be returned or ejected with manual assistance in the event of transverse offset or rotation.

### By the way

The return pays for itself within one year, starting from nine hours of use per week!

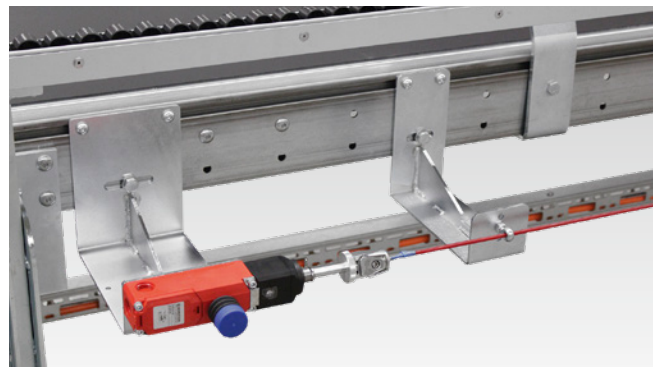

#### Equipment for CE conformity:

Pull cord longitudinally to the return belt.

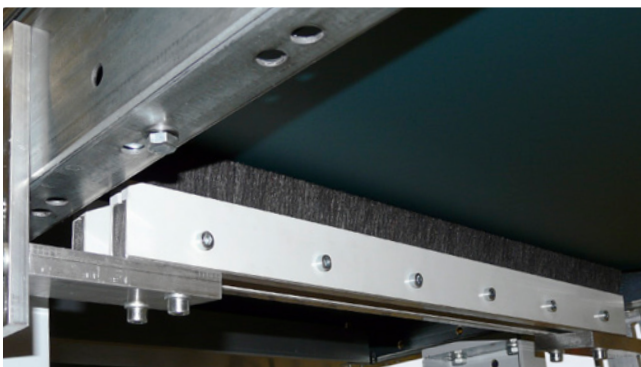

#### Cleaning the belts

For optimum protection against dust and chips.

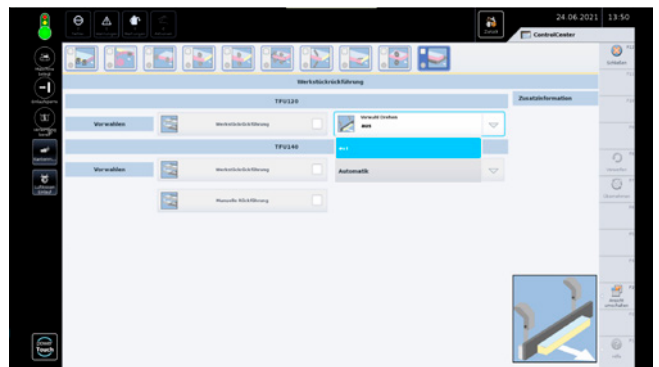

#### Return control system

The parameters for the operating modes are integrated in powerTouch.

# VALYOU

Our Mission, Your Performance.

## HC LIFE CYCLE SERVICES

Improved performance, more efficient processes, faster help, assurance of availability and smarter workin

### TEAM & COVERAGE

Largest global service network in the industry with over 1,350 personnel.

### INSTALLATION & COMMISSIONING

For a smooth start, we only let proven experts manage your setup.

### OPERATION & CONTROL

After teaching your personnel the intuitive control system, our clever apps help to make the operator's life much easier.

### MAINTENANCE & SERVICING

To keep things running, we're happy to take a preventative approach. You decide how often and how intensively you want the support to be. As we all know, prevention is better than the cure.

### eSHOP & ONLINE ADVANTAGE

A few clicks and it's fixed. Receive exclusive advantages by ordering spare parts online, depending on market availability.

[shop.homag.com](http://shop.homag.com)

### HOTLINE & READINESS

When there's an emergency, we're here. Direct by phone, digitally via app or video, or with on-site support. We are close to you with over 90 regional service organizations worldwide.

With more than 35,000 spare parts immediately available, we can deliver 85% of your orders fast.

### TRAINING & EDUCATION

With classroom, live online or eLearning training, we offer flexible options to help you get knowledge. We conduct over 4,000 customer training courses every year, and we even have our own training centers in 19 countries

### MODERNIZATION & IMPROVEMENT

Our modernization program is tailored to your machines and processes. We can evaluate your data and situation and advise you on the next step.

### ANALYSIS & SUSTAINABILITY

On request, we analyze all your processes with proven tools and procedures (LeanSixSigma). We have a large, certified team of experts for this purpose.

### FINANCING & CONSULTING

We offer you tailor-made financing concepts worldwide. With more than 60 years of experience and a close partner network of prominent banks and insurance companies to help us to find the right solution for you, we're always transparent and reliable in processing.

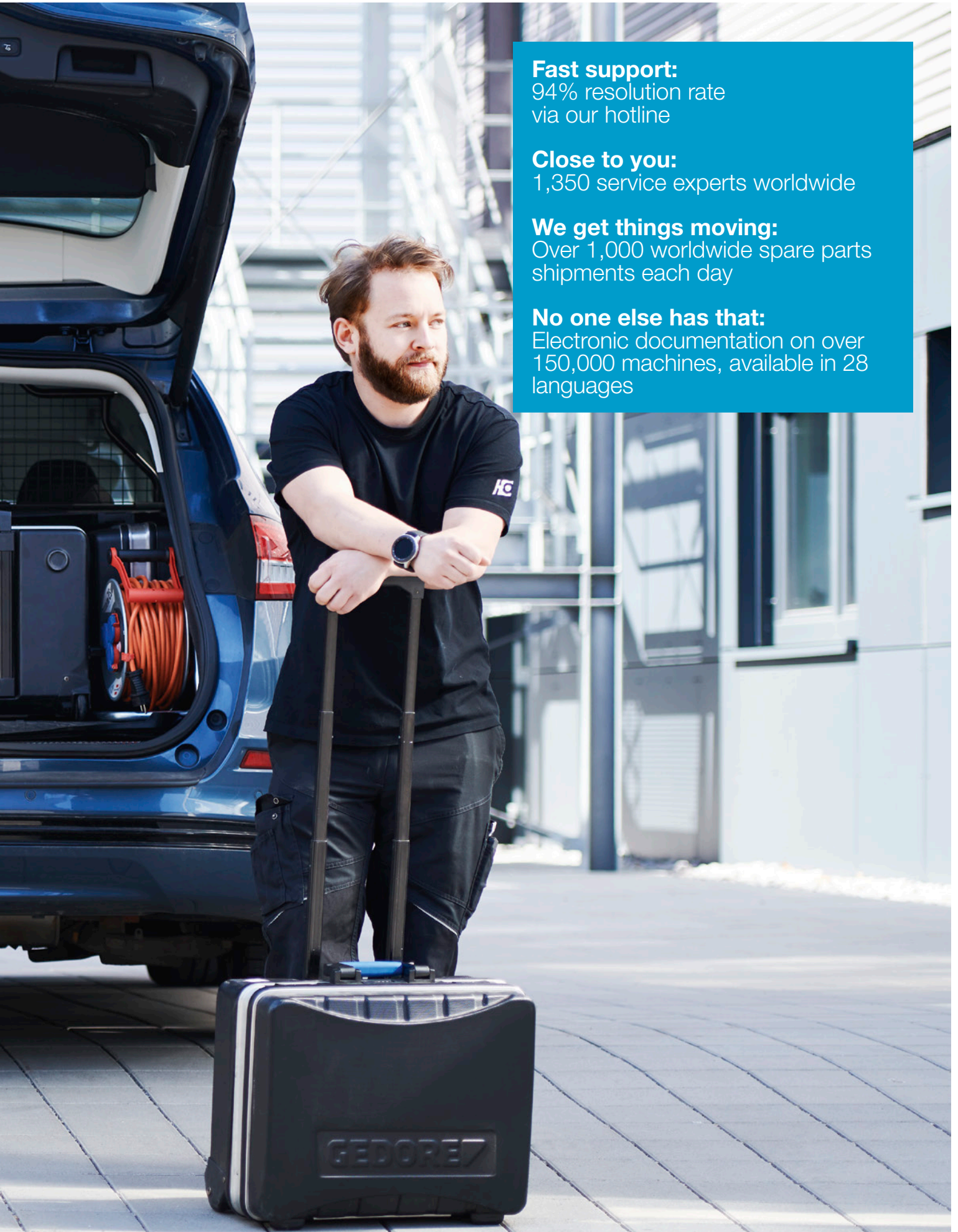

**Fast support:**

94% resolution rate  
via our hotline

**Close to you:**

1,350 service experts worldwide

**We get things moving:**

Over 1,000 worldwide spare parts  
shipments each day

**No one else has that:**

Electronic documentation on over  
150,000 machines, available in 28  
languages

As at 06/22 | Subject to technical change, print errors and mistakes. Images may show special features.



**HOMAG Group AG**

info@homag.com  
www.homag.com

**YOUR SOLUTION**