

GPPH PRODUCTS

PRO INOX | **PLUS** INOX | **ECO** | **XWT** | **BSC** | **DIY** | **MWT** | **SOG**



make **WELDING**
SIMPLE again



OFFER 2023

PROFESSIONAL WELDING TABLES



MADE IN POLAND

TABLE OF CONTENTS

1. WELDING TABLES – TRADITIONAL	
◦ PRO, PLUS, and ECO series – technical parameters	4
◦ PRO, PLUS, and ECO series – dimensions and price list – tables with legs on feet	6
◦ PRO, PLUS, and ECO series – dimensions and price list – tables with legs on wheels.....	7
◦ PRO, PLUS, and ECO series – stainless steel covers	8
2. WELDING TABLES – STAINLESS	
◦ INOX series – technical parameters	9
◦ INOX series – dimensions and price list – tables with legs on feet	11
◦ INOX series – dimensions and price list – tables with legs on wheels.....	12
3. WELDING TABLE WEIGHTS	
◦ Weights of traditional and stainless steel welding tables	13
4. WELDING TABLES – MODULAR	
◦ MWT series – technical parameters	14
◦ MWT series – dimensions and price list	15
5. WELDING TABLES – WELDING & ASSEMBLY TABLES	
◦ BASIC series – technical parameters	16
◦ BASIC series – dimensions and price list – tables with legs on feet	17
◦ BASIC series – dimensions and price list – tables with legs on wheels	18
◦ BASIC series – weights of welding tables	19
◦ DIY series – technical parameters and price	20
◦ DIY series – toolkits	21
6. WELDING TABLES – LIFTING (with hydraulic lifting system)	
◦ XWT series – technical parameters	22
◦ XWT series – dimensions and price list	23
7. GRINDING-WELDING STATION	
◦ SOG series – technical parameters	26
◦ SOG series – technical parameters and price list	27
8. TOOLS	
◦ PRO series tools	28
◦ PLUS series tools	29
◦ ECO series tools	30
◦ Universal tools	31
◦ Tool trolleys	32
◦ Tools – price list	33
◦ Toolkits	35

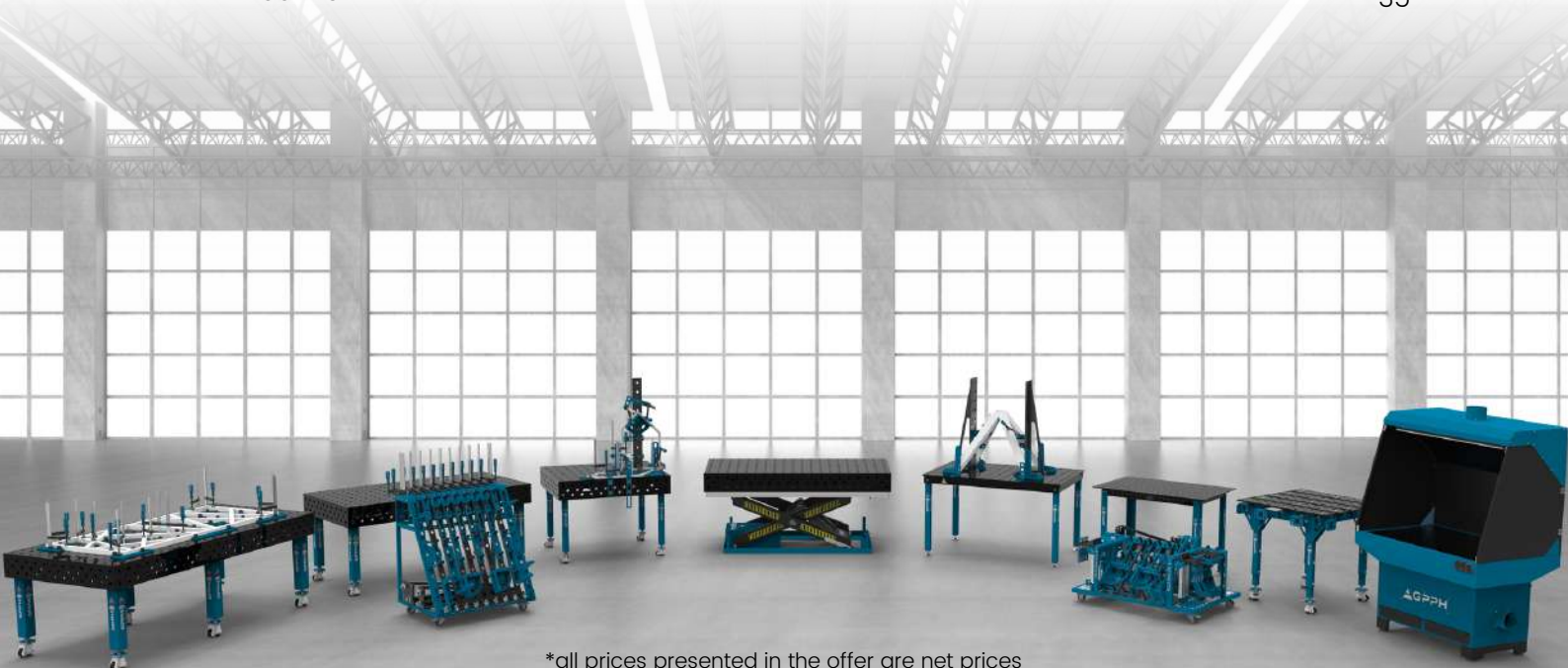

*all prices presented in the offer are net prices

WELDING TABLES – TRADITIONAL

PRO, PLUS, and ECO series – technical parameters

Traditional GPPH Welding Tables come in three series: **PRO**, **PLUS**, and **ECO**. Each of them is in as many as 10 versions of dimensions.

You will use them wherever precision during welding is needed. For example, you can use it for manual or robotic welding. As a result, your constructions will finally be made accurately, without unnecessary corrections!

It also ensures ergonomic and fast work while maintaining the precision and repeatability of the structures. All tables are available with legs on feet or legs on wheels – the choice is up to you!

Depending on your preferences, you can choose **PRO**, **PLUS**, and **ECO** Welding Tables in hole systems:

- fi 28 mm in a 100x100 mm grid
- fi 28 mm in a diagonal grid
- fi 16 mm in a 100x100 mm grid
- fi 16 mm in a diagonal grid
- fi 16 mm in a 50x50 mm grid

Tables are made of material S355J2+N according to ISO 2768-1. Each table top has an engraved scale. The engraved scale is vertical and horizontal lines in a 100x100mm grid. It is a reference point when laying the constructions and when assembling tools. Using measuring tools, you can set your structure correctly to get the required dimension.

All tables have ribs, which results in a perfectly flat work surface. Ribs are arranged every 400 mm on average. The massive and rigid foundation of the table top guarantees the highest stability during use and protection against deformation. Tables sidewalls have a height of 200 mm and are executed with a deviation tolerance of $\pm 0.3^\circ$.

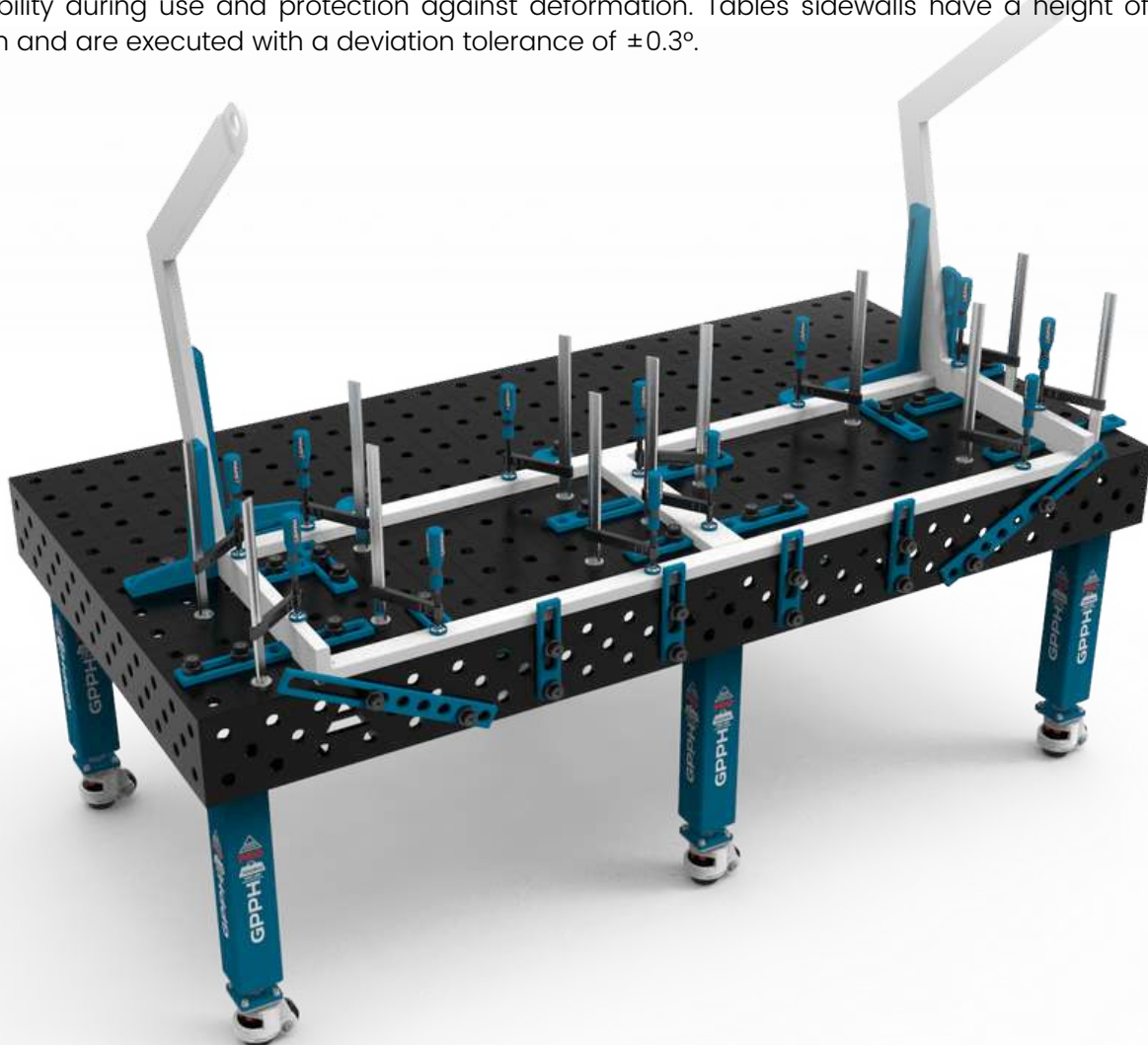

WELDING TABLES – TRADITIONAL

PRO, PLUS, and ECO series – technical parameters

Check the table below for the differences between the series of GPPH welding tables:

PARAMETER	PRO SERIES	PLUS SERIES	ECO SERIES
Tolerance on flatness for a table (on the whole worktop)*	±0,3 mm	±0,3 mm	±0,5 mm
Three grids of holes on the 4 sides	✓	✓	✓
Table top thickness	15 mm	12 mm	8 mm
Chamfered and milled holes	✓	✓	✗
Chamfered holes from bottom	✓	✓	✗
Holes manufacturing tolerance	+0,05 mm	+0,05 mm	±0,1 mm
Leg profile	100x100x4 mm	80x80x4 mm	60x60x4 mm
Capacity	700 kg / leg	500 kg / leg	250 kg / leg
Total load capacity for a table with 4 legs	2 800 kg	2 000 kg	1 000 kg
Total load capacity for a table with 6 legs	4 200 kg	3 000 kg	1 500 kg
Total load capacity for a table with 8 legs	5 600 kg	4 000 kg	2 000 kg
Milled table top edges	✓	✓	✗
Number of dimensional versions	10 versions	10 versions	10 versions

PRO, PLUS and ECO welding tables are available in the following sizes: 3000x1480 mm**, 2400x1200 mm, 2000x1000 mm, 1500x1480 mm, 1500x1000 mm, 1200x1200 mm, 1200x1000 mm, 1200x800 mm, 1000x1000 mm, 1000x1000 mm.

To work on the PRO series welding tables, you will use milled tools from the PRO series, and for the PLUS and ECO series welding tables – tools from the PLUS series. Thanks to them, you can precisely make any 2D flat and 3D spatial construction. And all this in much less time! You will find the tool PRO series on page 28 and the PLUS series on page 29.

*provided that the table is leveled correctly.

** The 3000x1480 GPPH welding table consists of two 1500x1480 GPPH welding tables connected to each other.

WELDING TABLES – TRADITIONAL

PRO, PLUS, and ECO series – dimensions and price list – tables with legs on feet

Price list for tables with legs on feet with a fi 28 mm or fi 16 mm hole system in a 100x100 mm grid:

Table top size [mm]	Net price PRO SERIES	Net price PLUS SERIES	Net price ECO SERIES
1000x600	1 520 EUR	1 060 EUR	790 EUR
1000x1000	1 760 EUR	1 280 EUR	990 EUR
1200x800	1 790 EUR	1 320 EUR	1 040 EUR
1200x1000	2 140 EUR	1 590 EUR	1 060 EUR
1200x1200	2 360 EUR	1 720 EUR	1 180 EUR
1500x1000	2 630 EUR	1 840 EUR	1 240 EUR
1500x1480	3 070 EUR	2 080 EUR	1 520 EUR
2000x1000	2 860 EUR	2 090 EUR	1 520 EUR
2400x1200	3 620 EUR	2 490 EUR	1 820 EUR
3000x1480	6 140 EUR	4 160 EUR	3 040 EUR

Price list for tables with legs on feet with a 28 mm or 16 mm hole system in a diagonal grid and for tables with a 16 mm hole system in a 50x50 mm grid:

Table top size [mm]	Net price PRO SERIES	Net price PLUS SERIES	Net price ECO SERIES
1000x600	1 820 EUR	1 320 EUR	890 EUR
1000x1000	2 070 EUR	1 570 EUR	1 090 EUR
1200x800	2 090 EUR	1 580 EUR	1 180 EUR
1200x1000	2 420 EUR	1 820 EUR	1 220 EUR
1200x1200	2 720 EUR	2 090 EUR	1 470 EUR
1500x1000	2 960 EUR	2 090 EUR	1 420 EUR
1500x1480	3 560 EUR	2 420 EUR	1 760 EUR
2000x1000	3 240 EUR	2 360 EUR	1 730 EUR
2400x1200	4 090 EUR	2 860 EUR	2 090 EUR
3000x1480	7 120 EUR	4 840 EUR	3 520 EUR

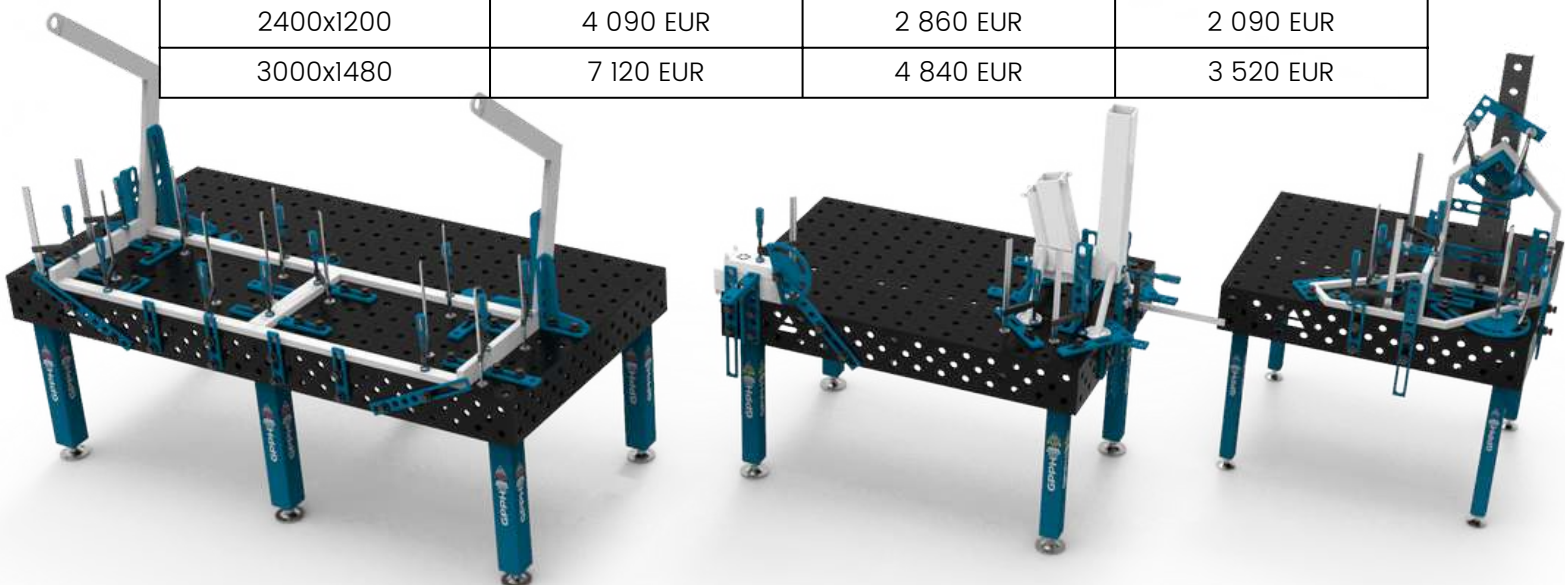

WELDING TABLES – TRADITIONAL

PRO, PLUS, and ECO series – dimensions and price list – tables with legs on wheels

Price list for tables with legs on wheels with a fi 28 mm or fi 16 mm hole system in a 100x100 mm grid:

Table top size [mm]	Net price PRO SERIES	Net price PLUS SERIES	Net price ECO SERIES
1000x600	1 776 EUR	1 280 EUR	962 EUR
1000x1000	2 016 EUR	1 500 EUR	1 162 EUR
1200x800	2 046 EUR	1 540 EUR	1 212 EUR
1200x1000	2 396 EUR	1 810 EUR	1 232 EUR
1200x1200	2 616 EUR	1 940 EUR	1 352 EUR
1500x1000	2 886 EUR	2 060 EUR	1 412 EUR
1500x1480	3 326 EUR	2 300 EUR	1 692 EUR
2000x1000	3 116 EUR	2 310 EUR	1 692 EUR
2400x1200	4 004 EUR	2 820 EUR	2 078 EUR
3000x1480	6 652 EUR	4 600 EUR	3 384 EUR

Price list for tables with legs on wheels with a 28 mm or 16 mm hole system in a diagonal grid and for tables with a 16 mm hole system in a 50x50 mm grid:

Table top size [mm]	Net price PRO SERIES	Net price PLUS SERIES	Net price ECO SERIES
1000x600	2 076 EUR	1 540 EUR	1 062 EUR
1000x1000	2 326 EUR	1 790 EUR	1 262 EUR
1200x800	2 346 EUR	1 800 EUR	1 352 EUR
1200x1000	2 676 EUR	2 040 EUR	1 392 EUR
1200x1200	2 976 EUR	2 310 EUR	1 642 EUR
1500x1000	3 216 EUR	2 310 EUR	1 592 EUR
1500x1480	3 816 EUR	2 640 EUR	1 692 EUR
2000x1000	3 496 EUR	2 580 EUR	1 902 EUR
2400x1200	4 474 EUR	3 190 EUR	2 348 EUR
3000x1480	7 632 EUR	5 280 EUR	3 864 EUR

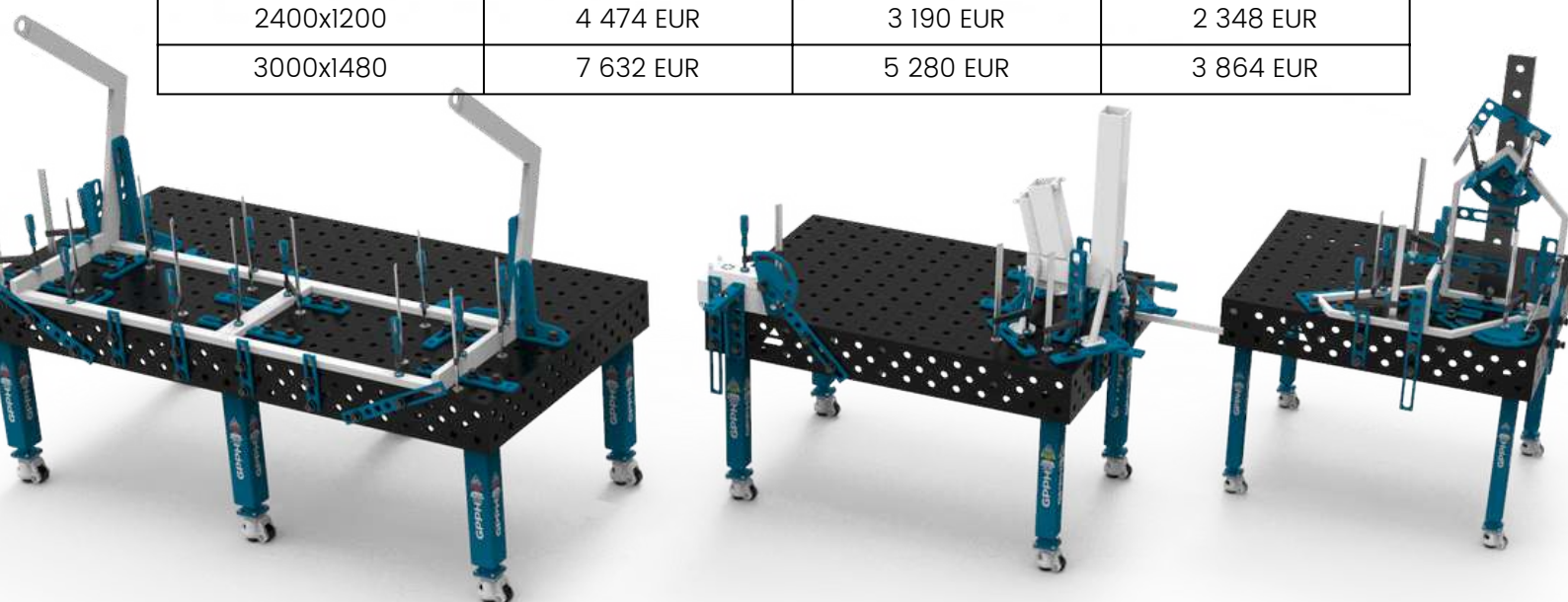

WELDING TABLES – TRADITIONAL

PRO, PLUS, and ECO series – stainless steel covers

For each welding table from the PRO, PLUS, and ECO series, you can buy a 1 mm thick stainless steel cover.

To transform the Traditional GPPH Welding Table into a table ideal for welding stainless steel, just put an overlay on it.

The hole patterns of the stainless steel cap are the same as the hole patterns of the GPPH welding tables.

Price list of stainless steel covers for tables with a fi 28 mm or fi 16 mm hole system in a 100x100 mm grid:

Table top size [mm]	Net price
1000x600	114 EUR
1000x1000	154 EUR
1200x800	154 EUR
1200x1000	178 EUR
1200x1200	199 EUR
1500x1000	215 EUR
1500x1480	246 EUR
2000x1000	274 EUR
2400x1200	372 EUR

Price list of stainless steel covers for tables with a 28 mm or 16 mm hole system in a diagonal grid and for tables with a 16 mm hole system in a 50x50 mm grid:

Table top size [mm]	Net price
1000x600	119 EUR
1000x1000	162 EUR
1200x800	162 EUR
1200x1000	189 EUR
1200x1200	214 EUR
1500x1000	226 EUR
1500x1480	262 EUR
2000x1000	292 EUR
2400x1200	392 EUR

WELDING TABLES – STAINLESS

INOX series – technical parameters

In our offer, you will find the Conventional Welding Tables GPPH INOX, which are available with **PRO** (15 mm) and **PLUS** (12 mm) series worktops. Each of them is available in ten versions of dimensions.

Stainless welding tables from the INOX series are made of 1.4301-grade stainless steel, which is characterized by better electrical conductivity than that of ordinary steel – electrical resistance at temperature 20°C = 0.73 ($\Omega \text{ mm}^2$)/m. You can use them where the precise welding of stainless steel is required.

Stainless welding tables are characterized by a high quality of execution and wear resistance. They are made of stainless steel with a high content of chromium which gives them **durability and corrosion resistance**. GPPH INOX welding tables ensure that there is no fear that iron will precipitate and that corrosion spots will be formed while welding stainless steel structures.

By using the INOX tables, your structures will be made **precisely and accurately** without any corrections. They ensure **ergonomic and effective work** while maintaining the high quality and repeatability of the executed structures. Moreover, the INOX tables series is also available in the version with legs on foot or wheels – the given table can be perfectly adapted to your needs.

Depending on your preferences, you may choose the INOX welding tables with worktops from the **PRO** or **PLUS** series with standard opening systems:

- fi 28 mm in a 100x100 mm grid
- fi 28 mm in a diagonal grid
- fi 16 mm in a 100x100 mm grid
- fi 16 mm in a diagonal grid
- fi 16 mm in a 50x50 mm grid

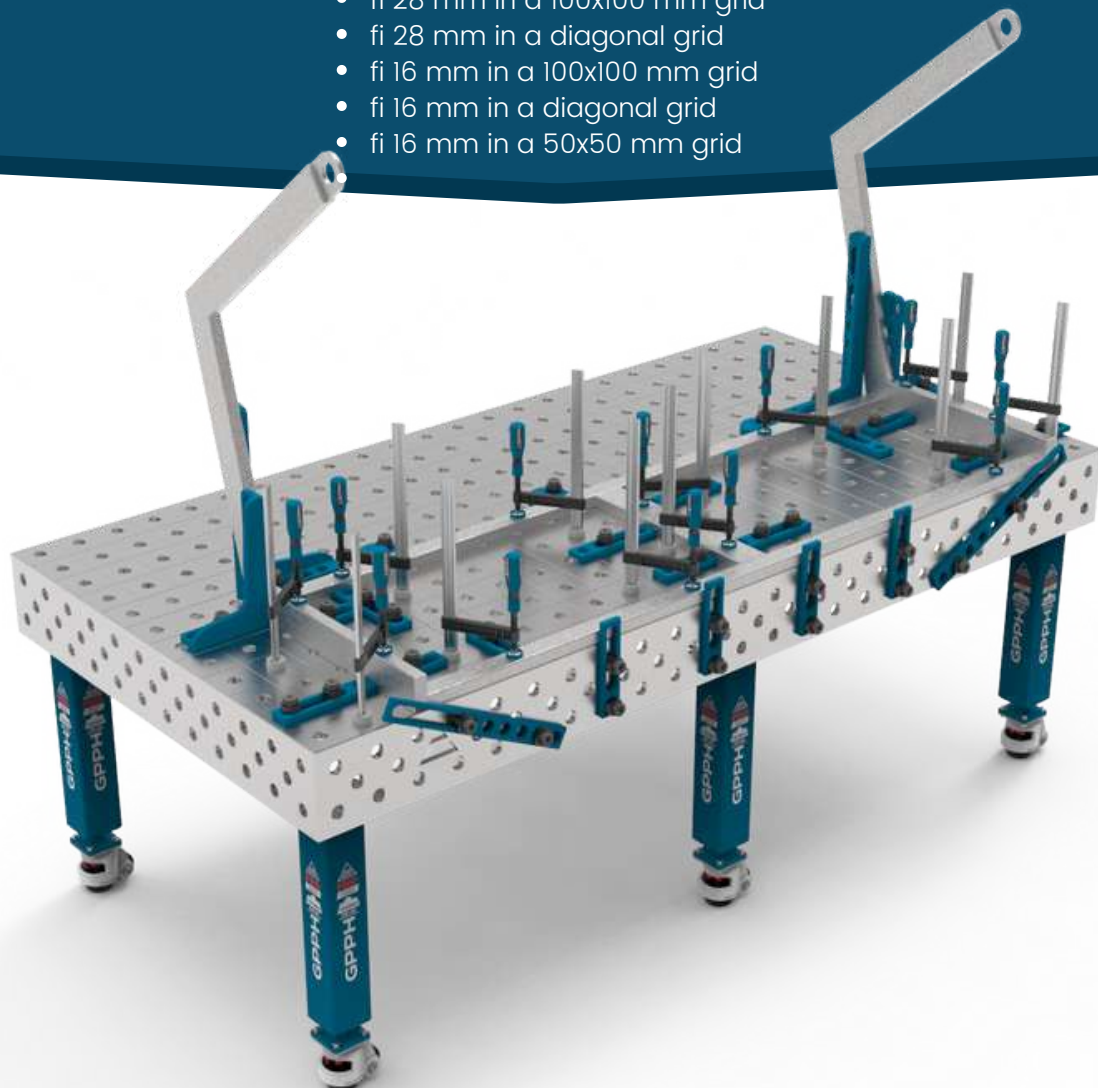

WELDING TABLES – STAINLESS

INOX series – technical parameters

Each worktop in the INOX version has an engraved pitch (more on the engraved pitch you will find on page 3). In addition, as in the case of conventional welding tables, the worktops have **robust and dense ribbing**, which affects the achievement of a **perfectly flat working surface** (tolerance on flatness ± 0.3 mm on the whole dimension of the worktop). The ribs are arranged every 400 mm on average. The robust and rigid structure of the worktop ensures maximum stability during operation and protects against deformation. The height of the sidewalls is 200 mm and they are made with a deviation tolerance of $\pm 0.3^\circ$.

On the INOX series welding tables with **PRO** worktops, you will use the PRO chamfered tools, while for the **PLUS** series worktops – the PLUS series tools. For works on the INOX tables, you may use the standard GPPH tools because they are powder coated. You will be able to execute precisely each flat and three-dimensional structure significantly faster using our tools! PRO series tools are presented on page 28, while the PLUS series is on page 29.

*Comparison of **PRO** and **PLUS** series worktops you will find on page 5.

INOX series welding tables with **PRO** and **PLUS** series worktops are available in the following dimensions: 3000x1480 mm**, 2400x1200 mm, 2000x1000 mm, 1500x1480 mm, 1500x1000 mm, 1200x1200 mm, 1200x1000 mm, 1200x800 mm, 1000x1000 mm, 1000x600 mm.



* The 3000x1480 GPPH welding table consists of two 1500x1480 GPPH welding tables connected to each other.

WELDING TABLES – STAINLESS

INOX series – dimensions and price list – tables with legs on feet

Price list for INOX tables with legs on feet with a fi 28 mm or fi 16 mm hole system in a 100x100 mm grid:

Table top size [mm]	Net price PRO SERIES worktop	Net price PLUS SERIES worktop
1000x600	4 120 EUR	2 990 EUR
1000x1000	5 860 EUR	3 990 EUR
1200x800	5 540 EUR	3 890 EUR
1200x1000	6 490 EUR	4 520 EUR
1200x1200	7 290 EUR	5 090 EUR
1500x1000	7 720 EUR	5 320 EUR
1500x1480	10 160 EUR	6 990 EUR
2000x1000	9 590 EUR	6 590 EUR
2400x1200	12 790 EUR	8 740 EUR
3000x1480	20 320 EUR	13 980 EUR

Price list for INOX tables with legs on feet with a 28 mm or 16 mm hole system in a diagonal grid and for tables with a 16 mm hole system in a 50x50 mm grid:

Table top size [mm]	Net price PRO SERIES worktop	Net price PLUS SERIES worktop
1000x600	4 540 EUR	3 520 EUR
1000x1000	6 290 EUR	4 540 EUR
1200x800	5 990 EUR	4 290 EUR
1200x1000	6 990 EUR	4 990 EUR
1200x1200	7 820 EUR	5 590 EUR
1500x1000	8 260 EUR	5 860 EUR
1500x1480	10 690 EUR	7 540 EUR
2000x1000	10 190 EUR	7 160 EUR
2400x1200	13 460 EUR	9 390 EUR
3000x1480	21 380 EUR	15 080 EUR

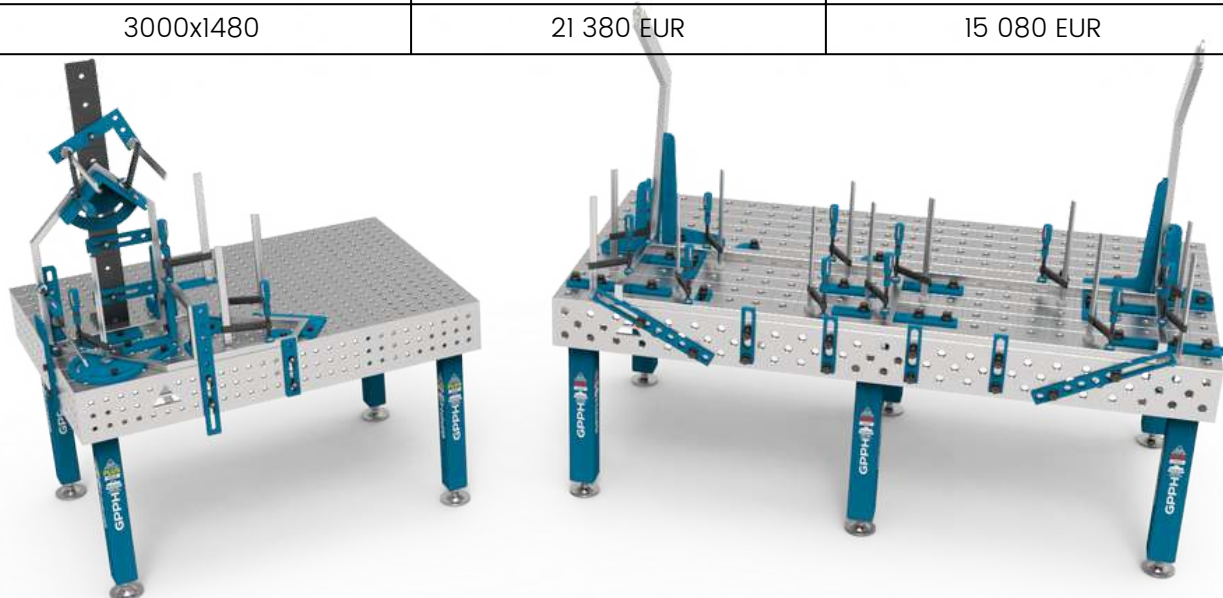

WELDING TABLES – STAINLESS

INOX series – dimensions and price list – tables with legs on wheels

Price list for INOX tables with legs on wheels with a fi 28 mm or fi 16 mm hole system in a 100x100 mm grid:

Table top size [mm]	Net price PRO SERIES worktop	Net price PLUS SERIES worktop
1000x600	4 376 EUR	3 210 EUR
1000x1000	6 116 EUR	4 210 EUR
1200x800	5 796 EUR	4 110 EUR
1200x1000	6 746 EUR	4 740 EUR
1200x1200	7 546 EUR	5 310 EUR
1500x1000	7 976 EUR	5 540 EUR
1500x1480	10 416 EUR	7 210 EUR
2000x1000	9 846 EUR	6 810 EUR
2400x1200	13 174 EUR	9 070 EUR
3000x1480	20 832 EUR	14 420 EUR

Price list for INOX tables with legs on wheels with a 28 mm or 16 mm hole system in a diagonal grid and for tables with a 16 mm hole system in a 50x50 mm grid:

Table top size [mm]	Net price PRO SERIES worktop	Net price PLUS SERIES worktop
1000x600	5 616 EUR	4 436 EUR
1000x1000	7 366 EUR	5 456 EUR
1200x800	7 066 EUR	5 206 EUR
1200x1000	8 066 EUR	5 906 EUR
1200x1200	8 896 EUR	6 506 EUR
1500x1000	9 336 EUR	6 776 EUR
1500x1480	11 766 EUR	8 456 EUR
2000x1000	11 266 EUR	8 076 EUR
2400x1200	15 074 EUR	10 764 EUR
3000x1480	23 532 EUR	16 912 EUR

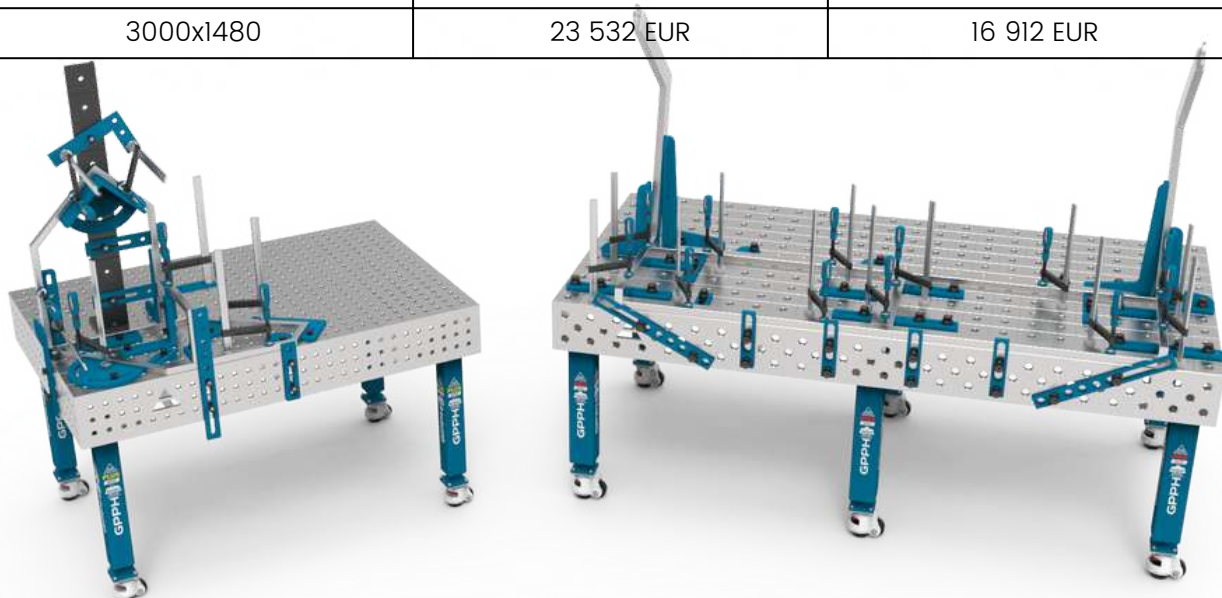

WELDING TABLES WEIGHTS

weights of traditional and stainless steel welding tables

Weights of traditional and stainless GPPH welding tables*:

Table dimensions [mm]	Weight of PRO series	Weight of PRO INOX series	Weight of PLUS series	Weight of PLUS INOX series	Weight of ECO series
1000x600	210 kg	210 kg	170 kg	170 kg	110 kg
1000x1000	280 kg	290 kg	230 kg	230 kg	150 kg
1200x800	270 kg	280 kg	220 kg	220 kg	140 kg
1200x1000	320 kg	320 kg	260 kg	260 kg	170 kg
1200x1200	350 kg	360 kg	280 kg	290 kg	190 kg
1500x1000	370 kg	380 kg	300 kg	310 kg	200 kg
1500x1480	490 kg	510 kg	390 kg	410 kg	270 kg
2000x1000	460 kg	480 kg	370 kg	380 kg	250 kg
2400x1200	630 kg	660 kg	510 kg	530 kg	340 kg
3000x1480	980 kg	1020 kg	780 kg	810 kg	530 kg

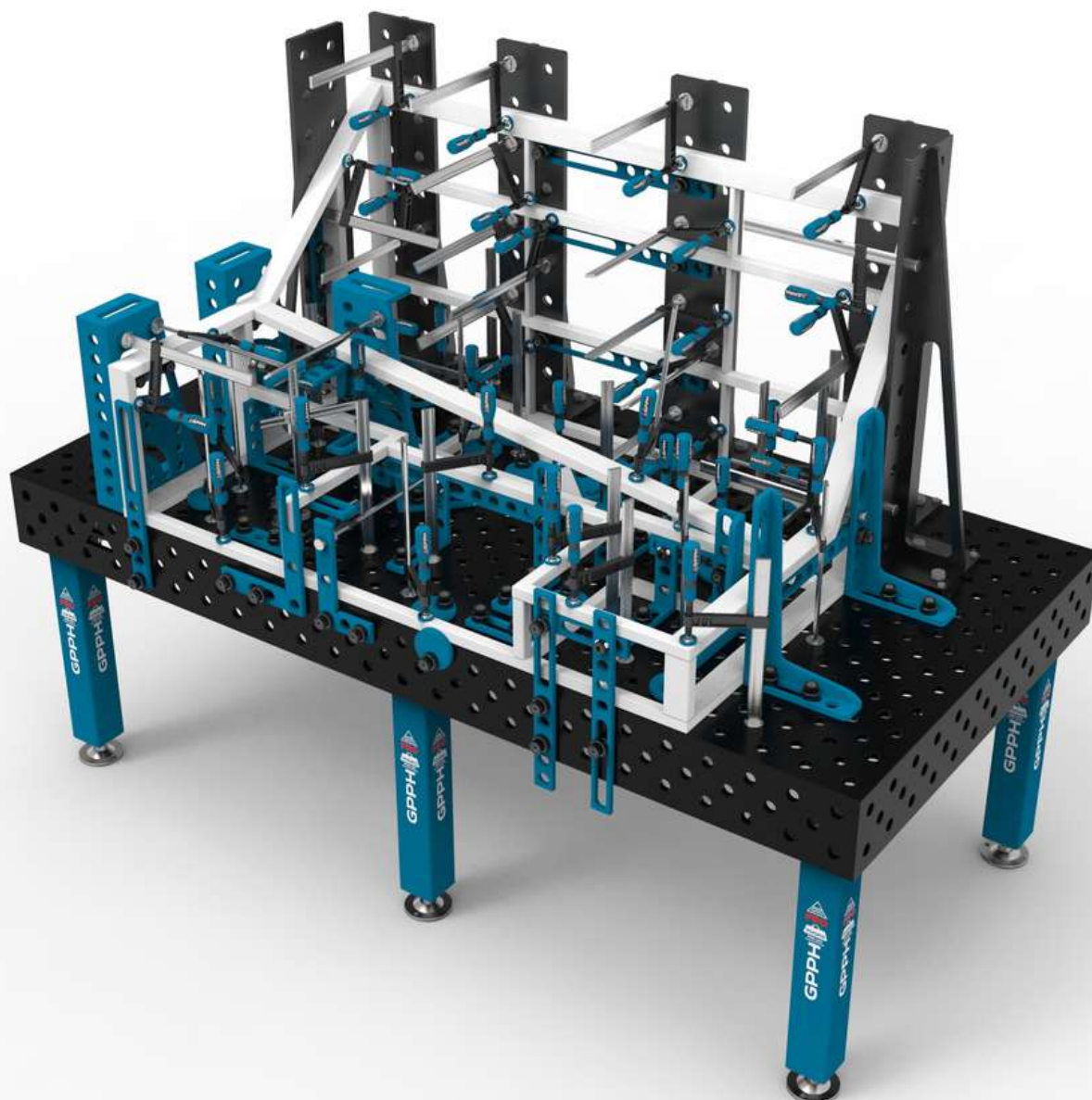

*these are approximate values

WELDING TABLES – MODULAR

MWT series – technical parameters

GPPH Modular Welding Tables are available in two variants of the top plates:

- material: S355J2+N
- material: tool steel subjected to the following treatment processes: nitriding + oxidation

The top of the modular tables consists of milled, sliding plates with a thickness of 15 mm, and by adjusting their surface, you will get **perfect flatness**. The plates are in a system of holes ϕ 28 mm in a 100x100 mm grid.

They have milled and chamfered holes to facilitate the assembly of tools. Modular tables are compatible with tools from the PRO series (more on page 28). In addition, the construction of our modular tables allows you to increase the number of mounting tools placed in the gaps between the tabletop boards – it's improving work ergonomics.

Modular tables have wheels with a foot in the basic legs, with a load capacity of 250 kg per leg. In the versions of extendable modular tables, there are adjustable supports in the additional legs. You can adjust the table high 850 mm – 1150 mm, P=50 mm.

You can combine the tables to get a larger work surface. Optionally, you can also purchase side plates.

Types of GPPH Modular Welding Tables:

- **SINGLE TABLE** – we offer three standard versions. They are ideal for small-scale production or serve as the basis for unlimited expansion of the surface of the welding station. They are in three dimensions: 1000x1000, 1200x1200, and 1600x1500.
- **EXTENDABLE SINGLE TABLE** – each table from our offer can be unfolded thanks to sliding plates and the use of additional legs. They are in three dimensions: 1770x1000, 2170x1200, and 2670x1600.
- **DOUBLE TABLE** – the most popular sets are sets composed of two single tables. The design of the tables allows expansion in every direction. They are in three dimensions: 2000x1000, 2400x1200, and 3200x1500.
- **SET WITH A LARGE WORK SURFACE** – connection of two unfolded tables by means of connectors is the perfect solution for spatial construction. They are in three dimensions: 2630x1770, 3030x2170, 4000x2670.



*the visualizations show Modular Welding Tables. From the top: Single table measuring 1200x1200 mm, Extendable single table measuring 2170x1200 mm, Double table measuring 2400x1200 mm, and Set with a large work surface measuring 2170x3030 mm. All tables in the visualizations have top plates made of S355J2+N steel.

WELDING TABLES – MODULAR

MWT series – dimensions and price list

Dimension [mm]	Material of the top plates: S355J2+N	Material of the top plates: tool steel subjected to the following treatment processes: nitriding + oxidation
SINGLE TABLE		
1000x1000	2 040 EUR	3 660 EUR
1200x1200	2 260 EUR	4 360 EUR
1600x1500	2 570 EUR	5 670 EUR
EXTENDABLE SINGLE TABLE		
1770x1000	2 220 EUR	3 670 EUR
2170x1200	2 480 EUR	4 570 EUR
2670x1600	2 880 EUR	5 990 EUR
DOUBLE TABLE		
2000x1000	4 080 EUR	7 320 EUR
2400x1200	4 520 EUR	8 720 EUR
3200x1500	5 140 EUR	11 340 EUR
SET WITH A LARGE WORK SURFACE		
2630x1770	4 290 EUR	7 160 EUR
3030x2170	4 700 EUR	8 890 EUR
4000x2670	5 300 EUR	11 490 EUR
SET OF SIDE PLATES		
for a single modular table with dimensions of 1000x1000	450 EUR	1 460 EUR
for a single modular table with dimensions of 1200x1200	490 EUR	1 820 EUR
for a single modular table with dimensions of 1600x1500	530 EUR	2 140 EUR



WELDING TABLES – WELDING & ASSEMBLY TABLES

BASIC series – technical parameters

WHERE WILL YOU USE THE BASIC WELDING TABLE? YOU CAN USE IT WHEREVER WELDING REQUIRES PRECISION.

It does not matter if your welding work is done classically by hand or you use welding robots – BASIC tables are a perfect choice! Your constructions will finally be made accurately, **without unnecessary corrections!**

We have an excellent solution for you if you use a welding robot for your work! The BASIC welding table is a **perfect base for robotic welding** and measuring stations. For such jobs, no side plates use. Therefore, the BASIC Welding Table meets all needs and is **more cost-effective** than Traditional Welding Tables with side plates.

Using milled tools from the PLUS series (see page 29), you will build an appropriate and easy-to-use work environment for making repeatable flat and spatial structures.

BASIC welding tables have:

- Perfectly flat work surface [± 0.3 mm on whole worktop];
- The massive and rigid base of the tabletop is 80mm high;
- Chamfered and milled holes for easy tool mounting, executed in tolerance $+0.05$ mm;
- Engraved scale in a 100x100mm grid;
- Height adjustment with standard legs approx. 880–930mm;
- All tables are rib reinforced, arranged every 400 mm on average;
- Milled table top edges;
- Tabletop thickness 12mm;
- Legs made of 60x60mm profile;
- Table load capacity up to 1,500 kg (250 kg/leg).

BASIC tables are available in the hole systems:

- fi 28 mm in a 100x100 mm grid;
- fi 16 mm in a 100x100 mm grid;
- fi 16 mm in a 50x50 mm grid;
- fi 16 mm in diagonal grid.

BASIC welding tables are available in the dimensions:

- 2400x1200,
- 2000x1000,
- 1500x1480,
- 1500x1000,
- 1200x1200,
- 1200x1000,
- 1200x800,
- 1000x1000,
- 1000x600.

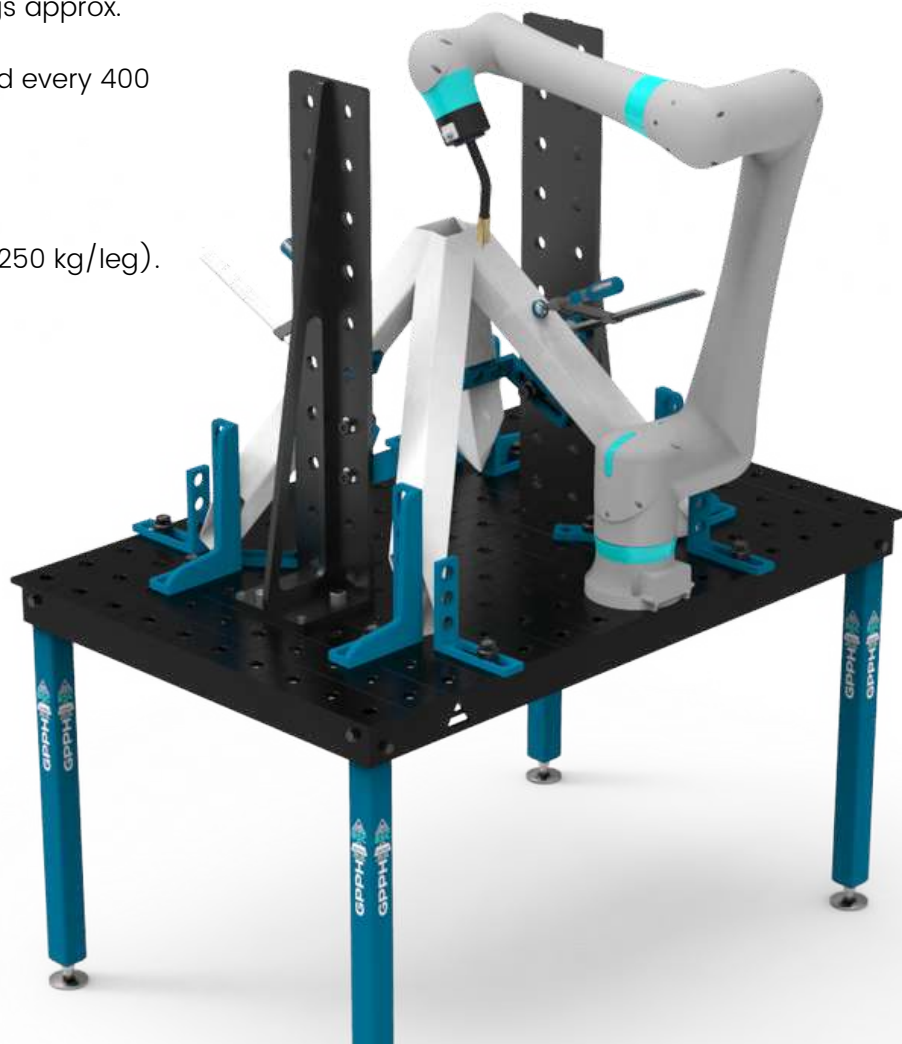

WELDING TABLES – WELDING & ASSEMBLY TABLES

BASIC series – dimensions and price list – tables with legs on feet

Price list for tables with legs on feet with a fi 28 mm or fi 16 mm hole system in a 100x100 mm grid:

Table top size [mm]	Net price
1000x600	760 EUR
1000x1000	980 EUR
1200x800	940 EUR
1200x1000	1 060 EUR
1200x1200	1 190 EUR
1500x1000	1 220 EUR
1500x1480	1 590 EUR
2000x1000	1 490 EUR
2400x1200	1 990 EUR

Price list for tables with legs on feet with a 16 mm hole system in a diagonal grid and for tables with a 16 mm hole system in a 50x50 mm grid:

Table top size [mm]	Net price
1000x600	860 EUR
1000x1000	1 070 EUR
1200x800	1 060 EUR
1200x1000	1 190 EUR
1200x1200	1 290 EUR
1500x1000	1 340 EUR
1500x1480	1 720 EUR
2000x1000	1 640 EUR
2400x1200	2 140 EUR

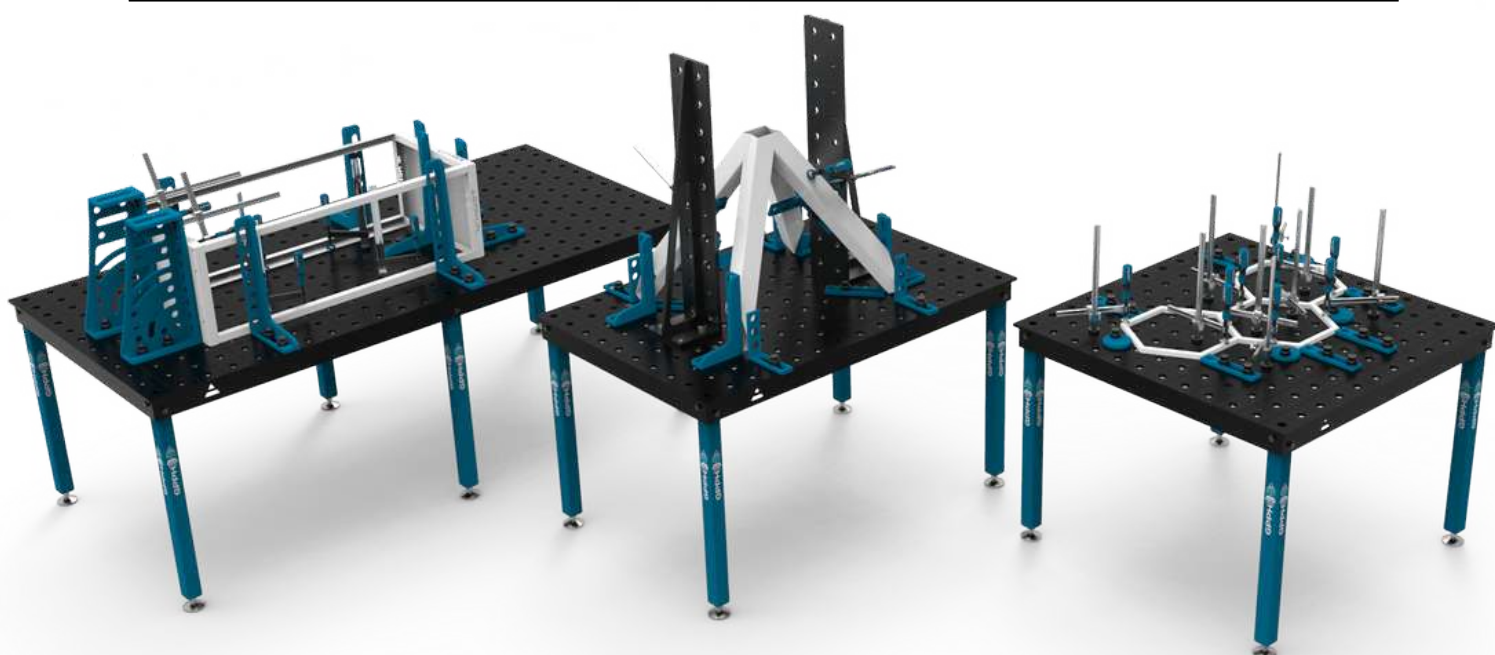

WELDING TABLES – WELDING & ASSEMBLY TABLES

BASIC series – dimensions and price list – tables with legs on wheels

Price list for tables with legs on wheels with a fi 28 mm or fi 16 mm hole system in a 100x100 mm grid:

Table top size [mm]	Net price
1000x600	932 EUR
1000x1000	1 152 EUR
1200x800	1 112 EUR
1200x1000	1 232 EUR
1200x1200	1 362 EUR
1500x1000	1 392 EUR
1500x1480	1 762 EUR
2000x1000	1 662 EUR
2400x1200	2 248 EUR

Price list for tables with legs on wheels with a 16 mm hole system in a diagonal grid and for tables with a 16 mm hole system in a 50x50 mm grid:

Table top size [mm]	Net price
1000x600	1 032 EUR
1000x1000	1 242 EUR
1200x800	1 232 EUR
1200x1000	1 362 EUR
1200x1200	1 462 EUR
1500x1000	1 512 EUR
1500x1480	1 892 EUR
2000x1000	1 812 EUR
2400x1200	2 398 EUR

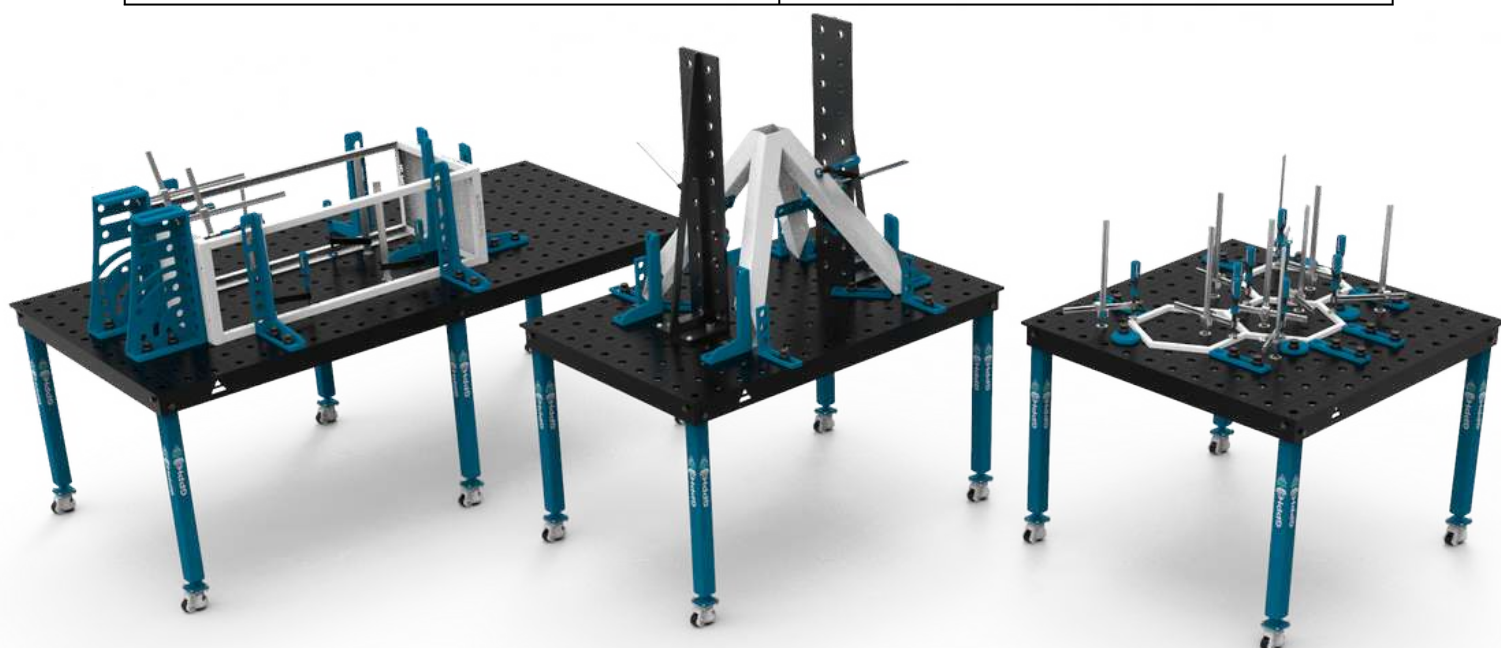

WELDING TABLES – WELDING & ASSEMBLY TABLES

BASIC series – weights of welding tables

Weights of GPPH welding tables from the BASIC series*:

Table top size [mm]	Weight
1000x600	110 kg
1000x1000	160 kg
1200x800	150 kg
1200x1000	180 kg
1200x1200	200 kg
1500x1000	220 kg
1500x1480	300 kg
2000x1000	280 kg
2400x1200	390 kg

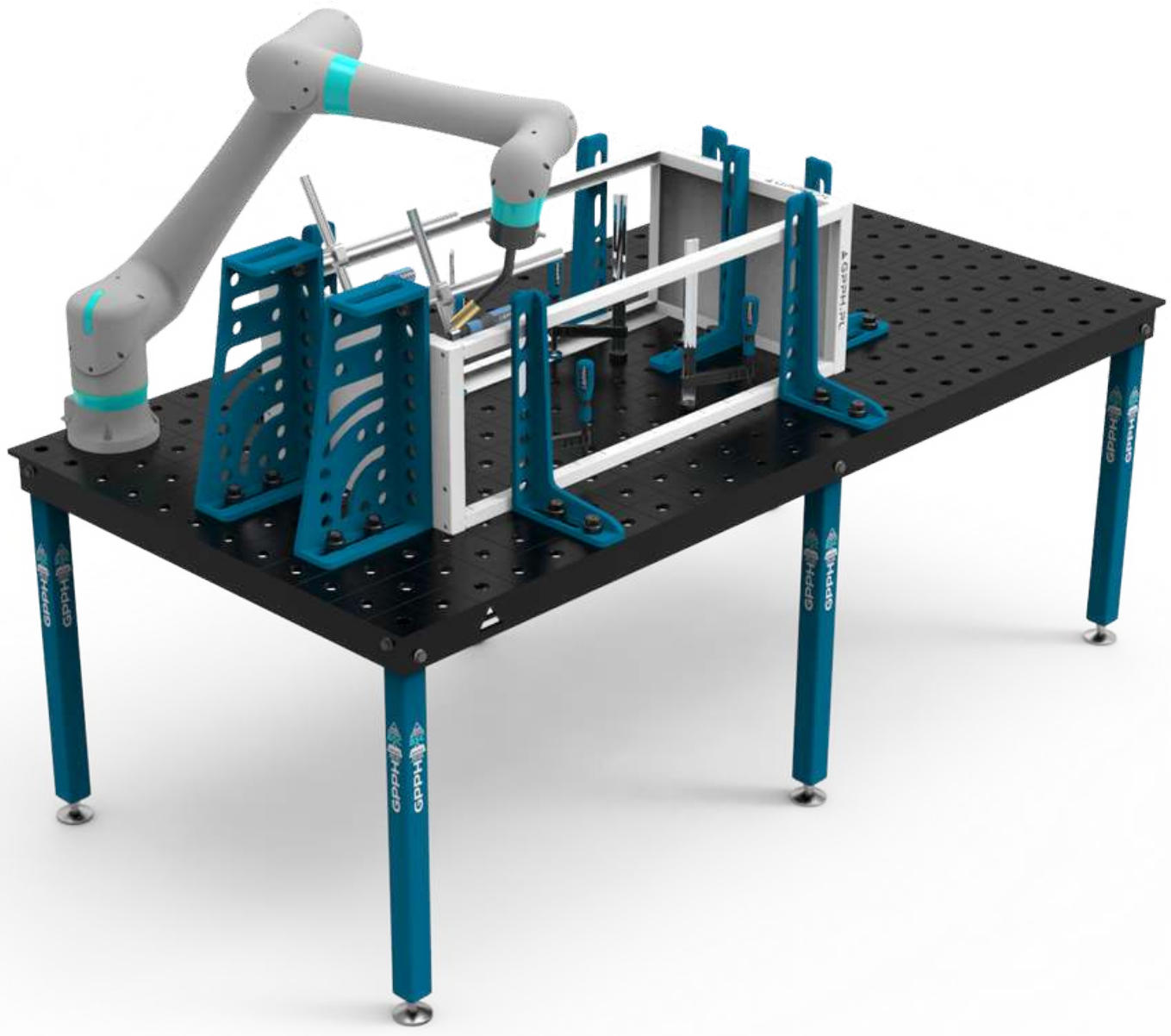

*these are approximate values

WELDING TABLES – WELDING & ASSEMBLY TABLES

DIY series – technical parameters and price

The DIY Welding and Assembly Table has a dimension of 1200x800 mm and is available in the version of holes 16 mm in a 50x50 mm grid. The holes have an execution tolerance of ± 0.1 mm. In addition, the DIY table has an engraved scale in a 100x100 mm grid. The height of the table is 880 mm. The DIY welding and assembly table is made of S355J2+N material.

DIY tables are **densely ribbed**, which affects their perfect flatness [$\pm 0,5$ mm on the whole worktop]. In addition, they have equipped with leveling feet that level the unevenness of the floor.

The DIY table top is 8 mm thick. The maximum load capacity of the table is 500 kg. The table weight is approx. 90 kg. This product will be perfect not only for the welder and the DIY enthusiast, carpenter, and car mechanic, as an auxiliary table for CNC machines and various workshops.

For DIY tables, tools from the PLUS series are compatible with the fast assembly bolt 19-22 ECO/PLUS (see tools on page 30).

ASSEMBLY-WELDING TABLE DIY CONSISTS OF:



DIY assembly-welding
table net price: 760 EUR

1. Metal rigid frame reinforced with ribs
2. Working table 8 [mm] thick made of S355J2+N steel
3. Legs equipped with leveling feet to compensate for unevenness of the flooring
4. Engraved scale in the grid 100x100 [mm] and assembly holes of system 16, in the grid 50x50 [mm]

ADDITIONAL ACCESSORIES FOR DIY TABLES:

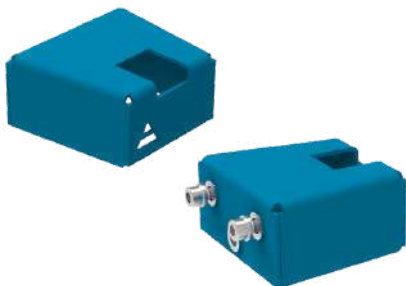

Adapter for tool shelves: 11,40 EUR / pcs.



Set of wheels for DIY table: 46 EUR / 4 pcs.

WELDING TABLES – WELDING & ASSEMBLY TABLES

DIY series – toolkits

For DIY welding and assembly tables, we offer two ready-made sets of tools from the PLUS series (you can find a presentation of all tools in this series on page 29) fastened with a fast assembly bolt 19-22 ECO/PLUS (see on page 30).

Tool kit no. 1 included shelf adapters to fit a mobile tool shelf to the side of a DIY tabletop.

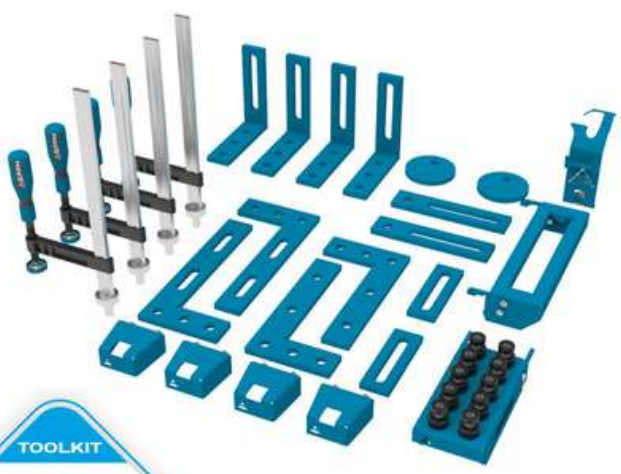

TOOLKIT
35
pieces
DIY no. 1

Price of Toolkit No. 1
for DIY Table:
1 063,60 EUR



TOOLKIT
13
pieces
DIY no. 2

Price of Toolkit No. 2
for DIY Table:
407 EUR

WELDING TABLES – LIFTING

with hydraulic lifting system – XWT series – technical parameters

GPPH welding tables with hydraulic lifting system are professional tables with automatic adjustment of table top height.

With it you will quickly and easily reach the ideal working height of the table top ensuring high comfort of work.

Welding tables with hydraulic lifting system are equipped with:

- overload valve preventing lifting too heavy loads;
- safety valve stopping the lowering in the case of rupture of the hydraulic lines;
- limit switches protecting against crushing or personal injury.

Welding tables with a hydraulic lifting system are available in the series of GPPH welding table tops:

- **PRO**, **PLUS**, and **ECO**, which are made of S355J2+N steel;
- **PRO INOX** and **PLUS INOX**, which are made of stainless steel of the 1.4301 grade.

(Differences between tabletop series can be found on page 5).

Each series is available in 4 sizes: 1500x1000 mm, 1500x1480 mm, 2000x1000 mm, 2400x1200 mm.

Furthermore, each table top is available with ϕ 28 mm holes in the grids: 100x100 mm and diagonal, and in the ϕ 16 mm holes system in the grids: 50x50 mm, 100x100 mm and diagonal.

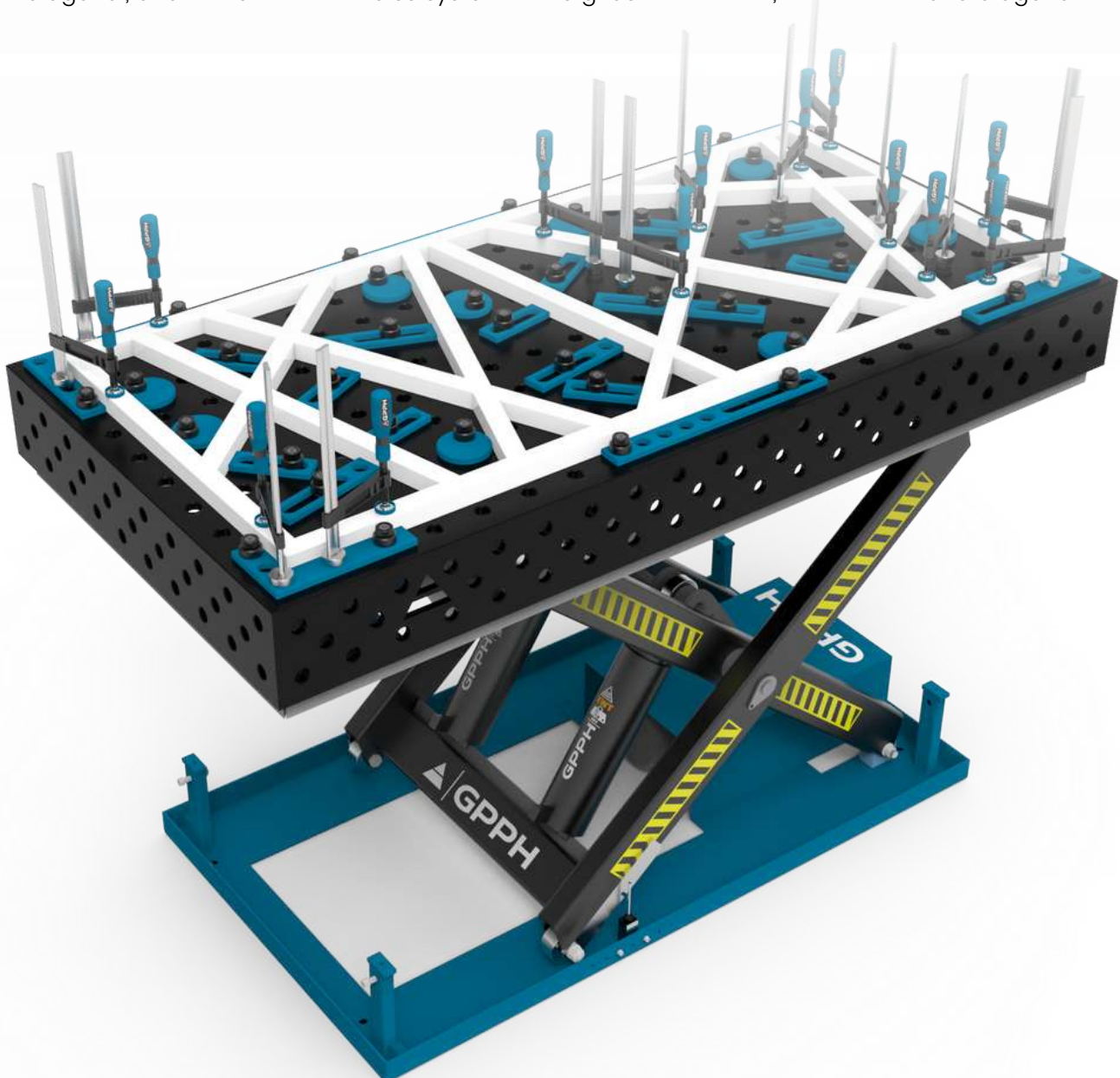

WELDING TABLES – LIFTING

with hydraulic lifting system – XWT series – technical parameters

Technical parameters of the base with hydraulic lifting system:

- supply voltage: 400 V
- revolutions: 1400 rpm
- protection class: IP54
- insulation class: F

Table dimensions [mm]	Max. load capacity [kg]	Lifting time with a load [s]	Max. table height [mm]	Min. table height [mm]	Dimensions of the base of the lifting [mm]	Motor power [kW]
1500x1000	1600	20-25	1150	480	1220x785	2.2
1500x1480	1500	20-25	1450	480	1220x785	2.2
2000x1000	3500	30-40	1200	550	1863x890	2.2
2400x1200	3400	45-55	1550	550	2000x900	2.2

Weights of the GPPH welding tables with hydraulic lifting system:

Table dimensions [mm]	Weight of XWT with table top from the PRO series [kg]	Weight of XWT with table top from the PLUS series [kg]	Weight of XWT with table top from the ECO series [kg]
1500x1000	638	568	468
1500x1480	779	679	559
2000x1000	865	775	655
2400x1200	1135	1015	845

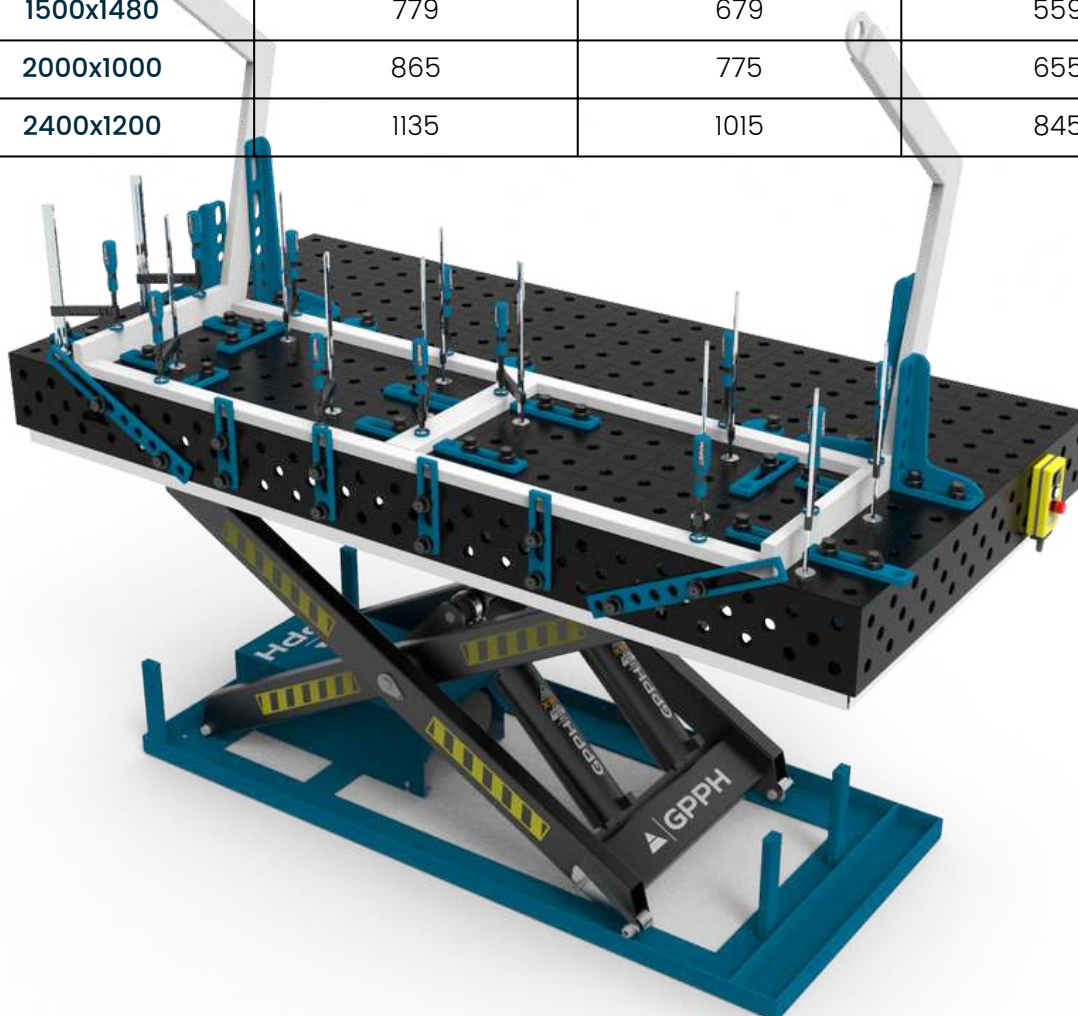

WELDING TABLES – LIFTING

with hydraulic lifting system – **XWT** series – dimensions and price list

Price list for the tables with a top made of S355J2+N steel with fi 28 mm and fi 16 mm holes system in a 100x100 mm grid:

Table top dimension [mm]	PRO SERIES net price	PLUS SERIES net price	ECO SERIES net price
1500x1000	4 620 EUR	3 830 EUR	3 230 EUR
1500x1480	5 210 EUR	4 220 EUR	3 660 EUR
2000x1000	5 600 EUR	4 830 EUR	4 260 EUR
2400x1200	6 710 EUR	5 580 EUR	4 910 EUR

Price list for the tables with a top made of S355J2+N steel with fi 28 mm and fi 16 mm holes system in a diagonal grid and for tables with fi 16 mm holes system in a 50x50 mm grid:

Table top dimension [mm]	PRO SERIES net price	PLUS SERIES net price	ECO SERIES net price
1500x1000	4 950 EUR	4 080 EUR	3 410 EUR
1500x1480	5 700 EUR	4 560 EUR	3 900 EUR
2000x1000	5 980 EUR	5 100 EUR	4 470 EUR
2400x1200	7 180 EUR	5 950 EUR	5 180 EUR

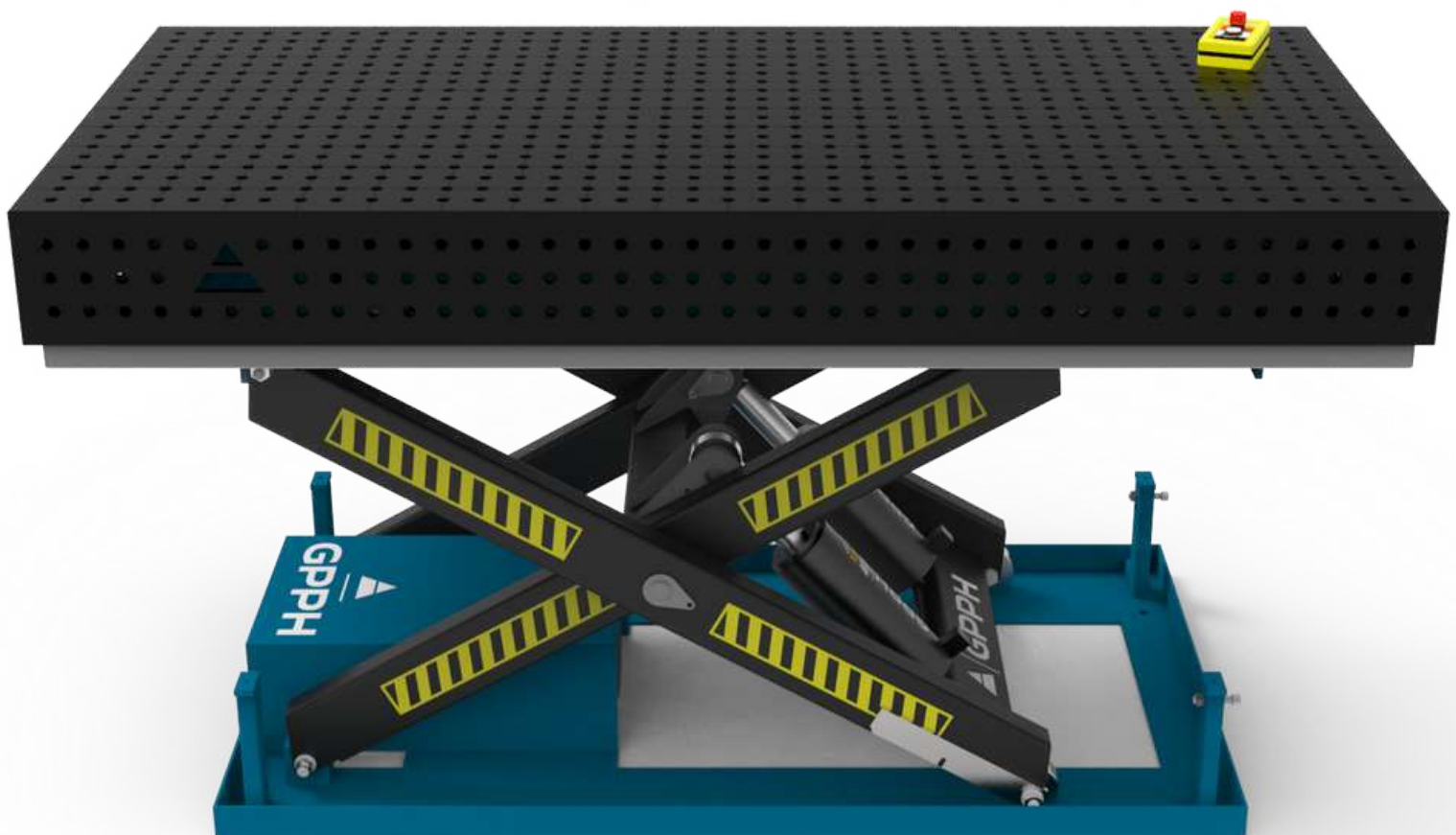

WELDING TABLES – LIFTING

with hydraulic lifting system – XWT series – dimensions and price list

Price list for the tables with a top made of stainless steel, grade 1.4301, with fi 28 mm and fi 16 mm holes system in a 100x100 mm grid:

Table top dimension [mm]	PRO INOX SERIES net price	PLUS INOX SERIES net price
1500x1000	9 710 EUR	7 310 EUR
1500x1480	12 300 EUR	9 130 EUR
2000x1000	12 330 EUR	9 330 EUR
2400x1200	15 880 EUR	11 830 EUR

Price list for the tables with a top made of stainless steel, grade 1.4301, with fi 28 mm and fi 16 mm holes system in a diagonal grid and for tables with fi 16 mm holes system in a 50x50 mm grid:

Table top dimension [mm]	PRO SERIES net price	PLUS SERIES net price
1500x1000	10 250 EUR	7 850 EUR
1500x1480	12 830 EUR	9 680 EUR
2000x1000	12 930 EUR	9 900 EUR
2400x1200	16 550 EUR	12 480 EUR

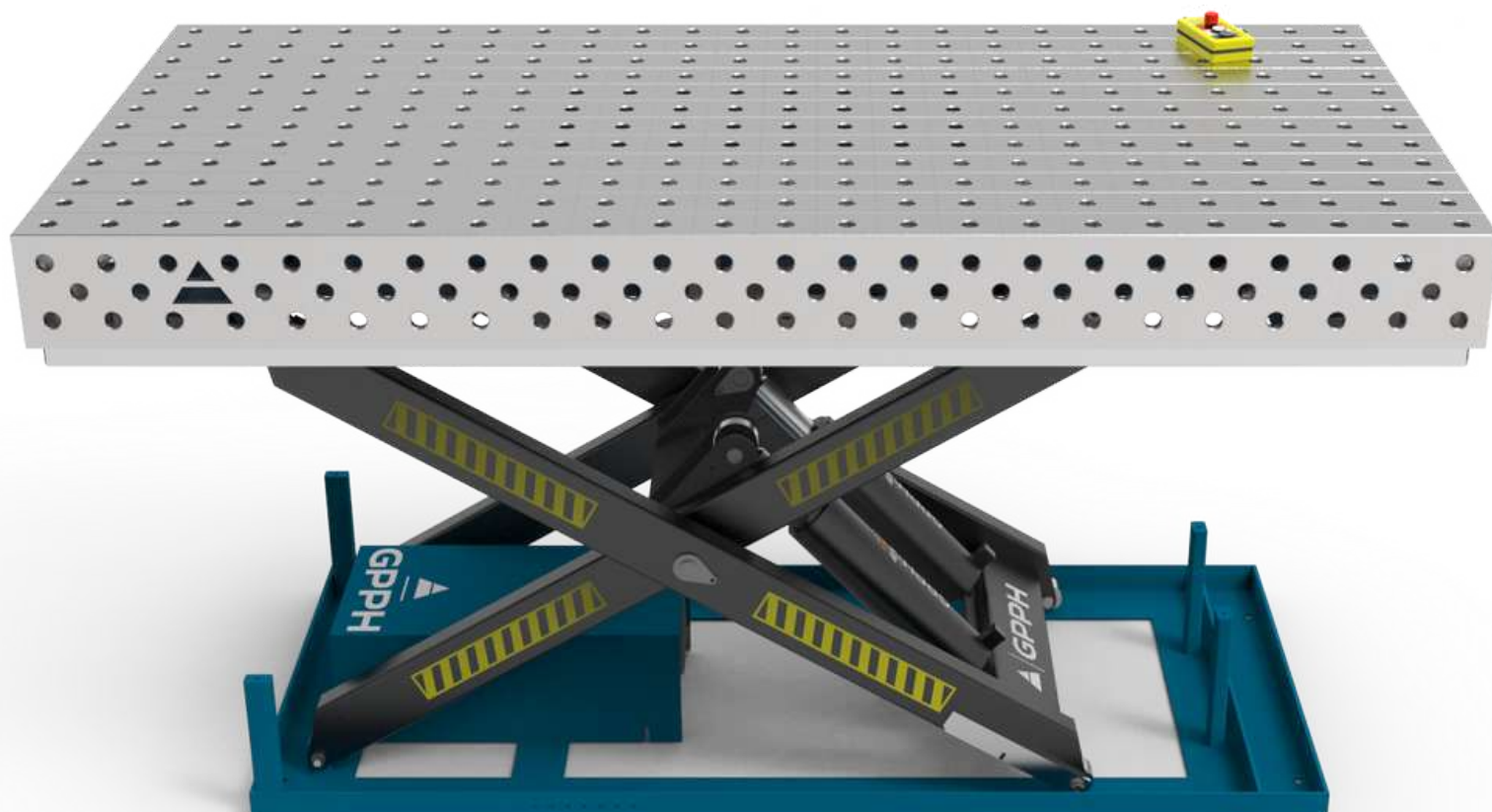

GRINDIG-WELDING STATION

SOG series – technical parameters

The grinding-welding station is intended for capturing and removing the dust and gases formed during grinding with a hand grinder or welding and metalworking operations. The station may be used with an exhaust fan or fan-powered filter equipment.

The GPPH grinding-welding station is available in three versions:

- Grinding-welding station – base
- Grinding-welding station – base with guards
- Grinding-welding station – base with top exhaust

The workstation base is adapted for the installation of guards and a top extraction system. Each variant of the grinding-welding station consists of a working table with a worktop made of 8 mm thick metal sheet.

Grinding-welding station is available in two versions of dimensions of the worktop:

- 1270x700 mm;
- 1870x770 mm.

Worktop has the assembly holes in a $\phi 28$ mm system with a 100x100 mm grid and additional holes for extraction of dust and gases.

Grinding-welding station with the covers is equipped with a back cover, while the variant with top extraction – the top extraction system. Both versions (with covers and top extraction) are equipped with tilting doors on the right and left – it allows positioning the items on the table which are longer than the width of the grinding-welding station.

Each SOG version is equipped with a connector $\phi 160$ mm installed in the side surface of the extraction trough. The air may be exhausted from the bottom through the table of extraction trough. All types of the grinding-welding station are equipped with an extraction trough with drawers, two 230V power outlets for the connection of power tools and a system for the connection of the lighting of the working space.

For GPPH grinding-welding stations, you can use PLUS series tools mounted with an adjustable 19–22 ECO/PLUS mandrel (see tools on page 30).



GRINDIG-WELDING STATION

SOG series – technical parameters and price list

Parameters for worktop with the dimensions:	1270x770 mm	1870x770 mm
BASE		
Weight	167 kg	225 kg
Resistance of flow	250 Pa	250 Pa
Recommended airflow for welding	1500 m ³ /h	2200 m ³ /h
Recommended airflow for grinding	3000 m ³ /h	4000 m ³ /h
Net price	2 640 EUR	3 990 EUR
BASE WITH GUARDS		
Weight	190 kg	250 kg
Resistance of flow	250 Pa	250 Pa
Recommended airflow for welding	1500 m ³ /h	2200 m ³ /h
Recommended airflow for grinding	3000 m ³ /h	4000 m ³ /h
Net price	2 970 EUR	4 140 EUR
BASE WITH TOP EXHAUST		
Weight	264 kg	315 kg
Resistance of flow	250 Pa	250 Pa
Recommended airflow for welding	1500 m ³ /h	2200 m ³ /h
Recommended airflow for grinding	3000 m ³ /h	4000 m ³ /h
Net price	3 560 EUR	5 090 EUR



BASE

BASE WITH GUARDS

BASE WITH TOP EXHAUST

PRO SERIES TOOLS

dedicated to tables: **PRO**, MWT and **XWT** with PRO series tops

Flat tools



STOP PRO 150

16_N_004_PRO | 28_N_004_PRO



STOP PRO 225

16_N_005_PRO | 28_N_005_PRO

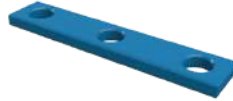

STOP PRO 260

16_N_006_PRO | 28_N_006_PRO



STOP PRO 500

16_N_007_PRO | 28_N_007_PRO



PROTRACTOR PRO

16_N_008_PRO | 28_N_008_PRO



ANGLE PRECISION SQUARE
(FLAT) PRO 275x150

16_N_009_PRO | 28_N_009_PRO



ANGLE PRECISION SQUARE
(FLAT) PRO 320x150

16_N_010_PRO | 28_N_010_PRO



ANGLE PRECISION SQUARE
(FLAT) PRO 350x250

16_N_011_PRO | 28_N_011_PRO

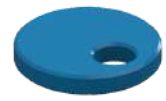

ECCENTRIC STOP
PRO Ø100mm

16_N_003_PRO | 28_N_003_PRO

Spatial tools



ANGLE BRACKET
PRO 185x175

16_N_012_PRO | 28_N_012_PRO



ANGLE BRACKET
PRO 200x200

16_N_013_PRO | 28_N_013_PRO



ANGLE BRACKET
PRO 300x190

16_N_014_PRO | 28_N_014_PRO



ANGLE BRACKET
PRO 450x250

16_N_015_PRO | 28_N_015_PRO



ANGLE BRACKET
PRO 275x500x175x100

16_N_016_PRO | 28_N_016_PRO

Increasing working surface



TABLE EXTENSION
PRO 1000X100

16_100x100_N_017_PRO
28_100x100_N_017_PRO



TABLE EXTENSION
PRO 1000X200

16_100x100_N_018_PRO
28_100x100_N_018_PRO



WELDING CONNECTION BLOCK
PRO 1000X200X200

16_50x50_N_019_PRO
16_100x100_N_019_PRO
28_100x100_N_019_PRO

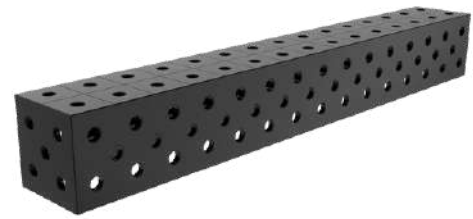

WELDING CONNECTION BLOCK
PRO 1500X200X200

16_50x50_N_020_PRO
16_100x100_N_020_PRO
28_100x100_N_020_PRO

Assembly tools



MOUNTING PIN PRO

16_T_015_PRO | 28_T_015_PRO



FAST ASSEMBLY BOLT
30 PRO

16_N_002_PRO | 28_N_002_PRO



MAGNETIC FAST ASSEMBLY
BOLT PRO

16_N_002_PRO_MG
28_N_002_PRO_MG



FAST ASSEMBLY BOLT UNI

16_N_002_UNI | 28_N_002_UNI

PLUS SERIES TOOLS

dedicated to tables: **PLUS**, **BASIC**, and **XWT** with PLUS series tops
as well as for tables: **ECO**, **DIY**, **XWT** with tops from the ECO series and for **SOG** stations**

Flat tools



STOP PLUS 150

16_N_004_PLUS | 28_N_004_PLUS



STOP PLUS 225

16_N_005_PLUS | 28_N_005_PLUS

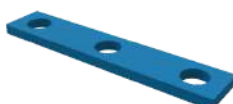

STOP PLUS 260

16_N_006_PLUS | 28_N_006_PLUS



STOP PLUS 500

16_N_007_PLUS | 28_N_007_PLUS

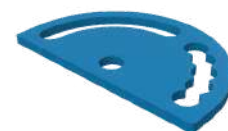

PROTRATOR PLUS

16_N_008_PLUS | 28_N_008_PLUS



ANGLE PRECISION SQUARE
(FLAT) PLUS 275x150

16_N_009_PLUS | 28_N_009_PLUS



ANGLE PRECISION SQUARE
(FLAT) PLUS 320x150

16_N_010_PLUS | 28_N_010_PLUS



ANGLE PRECISION SQUARE
(FLAT) PLUS 350x250

16_N_011_PLUS | 28_N_011_PRO



ECCENTRIC STOP
PLUS Ø100mm

16_N_003_PLUS | 28_N_003_PLUS

Spatial tools



ANGLE BRACKET
PLUS 185x175

16_N_012_PLUS | 28_N_012_PLUS



ANGLE BRACKET
PLUS 200x200

16_N_013_PLUS | 28_N_013_PLUS



ANGLE BRACKET
PLUS 300x190

16_N_014_PLUS | 28_N_014_PLUS



ANGLE BRACKET
PLUS 450x250

16_N_015_PLUS | 28_N_015_PLUS



ANGLE BRACKET
PLUS 275x500x175x100

16_N_016_PLUS | 28_N_016_PLUS

Increasing working surface



TABLE EXTENSION
PLUS 1000X100

16_100x100_N_017_PLUS
28_100x100_N_017_PLUS



TABLE EXTENSION
PLUS 1000X200

16_100x100_N_018_PLUS
28_100x100_N_018_PLUS



WELDING CONNECTION BLOCK
PLUS 1000X200X200

16_50x50_N_019_PLUS
16_100x100_N_019_PLUS
28_100x100_N_019_PLUS



WELDING CONNECTION BLOCK
PLUS 1500X200X200

16_50x50_N_020_PLUS
16_100x100_N_020_PLUS
28_100x100_N_020_PLUS

Assembly tools



MOUNTING PIN PLUS

16_T_015_PLUS | 28_T_015_PLUS



FAST ASSEMBLY BOLT
23 PLUS

16_N_002_PLUS | 28_N_002_PLUS



MAGNETIC FAST ASSEMBLY
BOLT PLUS

16_N_002_PLUS_MG
28_N_002_PLUS_MG



FAST ASSEMBLY BOLT UNI

16_N_002_UNI | 28_N_002_UNI

*all tools are available in fi 16 mm and fi 28 mm holes.

**in this case (tables: ECO, DIY, XWT with an ECO series top and SOG stands), the tools are mounted with a fast assembly bolt 19-22 ECO/PLUS - you will find it on page 30.

ECO SERIES TOOLS

dedicated to increasing the working surface of ECO tables and for mounting PLUS series tools on tables: ECO, DIY, XWT series with ECO series tops and on SOG stations**

Increasing working surface



TABLE EXTENSION
ECO 1000X100

16_100x100_N_017_ECO
28_100x100_N_017_ECO



TABLE EXTENSION
ECO 1000X200

16_100x100_N_018_ECO
28_100x100_N_018_ECO



WELDING CONNECTION BLOCK

ECO 1000X200X200

16_50x50_N_019_ECO
16_100x100_N_019_ECO
28_100x100_N_019_ECO



WELDING CONNECTION BLOCK

ECO 1500X200X200

16_50x50_N_020_ECO
16_100x100_N_020_ECO
28_100x100_N_020_ECO

Assembly tools



MOUNTING PINECO

16_T_015_ECO | 28_T_015_ECO



FAST ASSEMBLY BOLT

19-22 ECO/PLUS
16_N_002_ECO_PLUS
28_N_002_ECO_PLUS



MAGNETIC FAST ASSEMBLY
BOLT PLUS

16_N_002_PLUS_MG
28_N_002_PLUS_MG



FAST ASSEMBLY BOLT UNI

16_N_002_UNI | 28_N_002_UNI



*all tools are available in fi 16 mm and fi 28 mm holes.

**in this case, the tools are mounted using the 19-22 PLUS/ECO adjustable mandrel - you will find it on this page in the "Assembly tools" section

UNIVERSAL TOOLS

dedicated to all GPPH tables and stations

Fastening clamps



FASTENING CLAMP
16_N_001A | 28_N_001A



FASTENING CLAMP
WITH LEVER
16_N_001B | 28_N_001B



VARIABLE THROAT
DEPTH CLAMP
16_N_001C | 28_N_001C



VARIABLE THROAT DEPTH
WITH LEVER CLAMP
16_N_001D | 28_N_001D



FASTENING CLAMP
16_N_001E | 28_N_001E



FASTENING CLAMP
WITH LEVER
16_N_001F | 28_N_001F

Prisms, welding torch handle



PRISM Ø58MM 130°
16_N_021 | 28_N_021



PRISM Ø58MM 130°/90°
16_N_023 | 28_N_023



PRISM Ø58MM 90°
16_N_022 | 28_N_022



WELDING TORCH HANDLE
N_024

Mobile tool shelves



FAST ASSEMBLY BOLT SHELF S
16_T_011A | 28_T_011A



FAST ASSEMBLY BOLT SHELF M
16_T_011B | 28_T_011B



CLAMP SHELF S
16_T_011C | 28_T_011C



CLAMP SHELF M
16_T_011D | 28_T_011D



FLAT SHELF S
16_T_011E | 28_T_011E



FLAT SHELF M
16_T_011F | 28_T_011F



FLAT SHELF L
16_T_011G | 28_T_011G

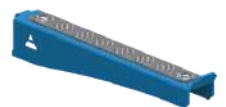

MOBILE SHELF FOR EXTENSIONS
T_011J



MIX SHELF
16_T_011H | 28_T_011H



DOCUMENTATION SHELF
16_T_011I | 28_T_011I

TOOL TROLLEYS

maintaining order at the workplace

Tool trolley M

16_T_012B | 28_T_012B

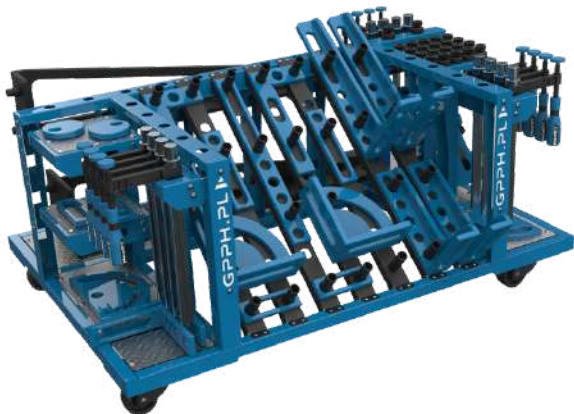

One of the many advantages of the small tool trolley is that it fits under most dimensions of GPPH Welding Tables. You have all the tools at your fingertips while working!

Tool trolley L

16_T_012A | 28_T_012A

The large GPPH tool trolley will accommodate a set of tools even for the most demanding user! Thanks to it, your workplace will become transparent like never before, and GPPH tools will be clearly arranged and more accessible.



*tool trolleys are available in the version of holes fi 16 mm and fi 28 mm. You can check the price of tool trolleys on page 33



TOOLS

price list

TOOL	PRICE		
	PRO SERIES	PLUS SERIES	ECO SERIES
FLAT TOOLS			
Stop 150	29 EUR	21 EUR	
Stop 225	33 EUR	24 EUR	
Stop 260	36 EUR	26 EUR	
Stop 500	52 EUR	38 EUR	
Protractor	57 EUR	48 EUR	
Angle precision square (flat) 275x150	48 EUR	43 EUR	
Angle precision square (flat) 320x150	55 EUR	50 EUR	
Angle precision square (flat) 350x250	67 EUR	62 EUR	
Eccentric stop Ø100	31 EUR	24 EUR	
SPATIAL TOOLS			
Angle bracket 185x175	72 EUR	50 EUR	
Angle bracket 200x200	105 EUR	88 EUR	
Angle bracket 300x190	88 EUR	76 EUR	
Angle bracket 450x250	117 EUR	107 EUR	
Angle bracket 275x500x175x100	236 EUR	186 EUR	
INCREASING WORKING SURFACE			
Table extension 1000x100	226 EUR	167 EUR	141 EUR
Table extension 1000x200	286 EUR	214 EUR	164 EUR
Welding connection block 1000x200x200 Ø16 mm, grid 50x50 mm	510 EUR	410 EUR	310 EUR
Welding connection block 1000x200x200 Ø16 mm / Ø28 mm, grid 100x100 mm	449 EUR	354 EUR	239 EUR
Welding connection block 1500x200x200 Ø16 mm, grid 50x50 mm	640 EUR	520 EUR	380 EUR
Welding connection block 1500x200x200 Ø16 mm / Ø28 mm, grid 100x100 mm	599 EUR	499 EUR	329 EUR
ASSEMBLY TOOLS			
Mounting pin	9 EUR	9 EUR	9 EUR
Fast assembly bolt 30 PRO	33 EUR		
Fast assembly bolt 23 PLUS		31 EUR	
Fast assembly bolt 19-22 ECO/PLUS			31 EUR
Magnetic fast assembly bolt PRO	35,60 EUR		
Magnetic fast assembly bolt PLUS		35,60 EUR	
Fast assembly bolt UNI	43 EUR		

TOOLS

price list

TOOL	PRICE
FASTENING CLAMPS	
Fastening clamp	31 EUR
Fastening clamp with lever	55 EUR
Variable throat depth clamp	71 EUR
Variable throatdepth with lever clamp	96 EUR
Fastening clamp	43 EUR
Fastening clamp with lever	77 EUR
PRISMS, WELDING TORCH HANDLE	
Prism Ø58mm 130°	12 EUR
Prism Ø58mm 130°/90°	17 EUR
Prism Ø58mm 90°	12 EUR
Welding torch handle	24 EUR
MOBILE TOOL SHELVES	
Fast assembly bolt shelf S	17 EUR
Fast assembly bolt shelf M	19 EUR
Clamp shelf S	17 EUR
Clamp shelf M	19 EUR
Flat shelf S	22 EUR
Flat shelf M	24 EUR
Flat shelf L	26 EUR
Mobile shelf for extensions	12 EUR
MIX shelf	33 EUR
Documentation shelf	24 EUR
TOOL TROLLEYS	
Tool trolley M	669 EUR
Tool trolley L	669 EUR

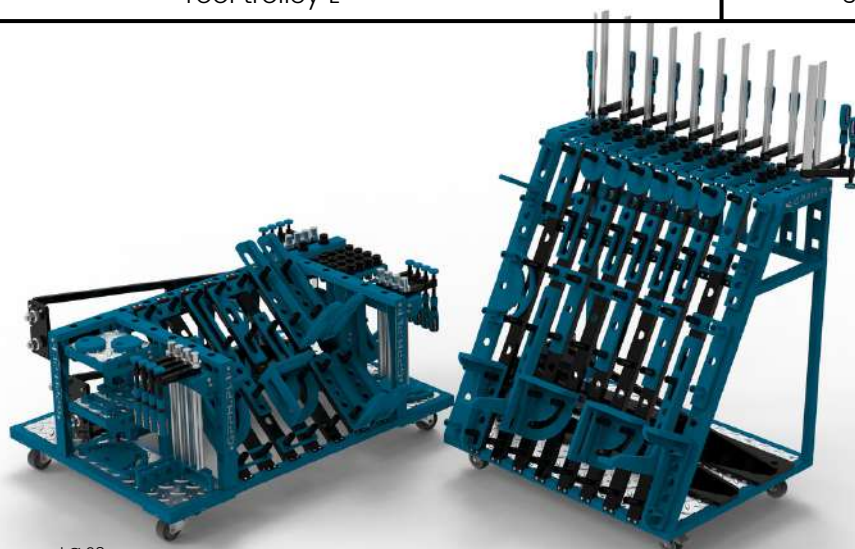

TOOLKITS

each toolkit is available in the PRO and PLUS series tool**

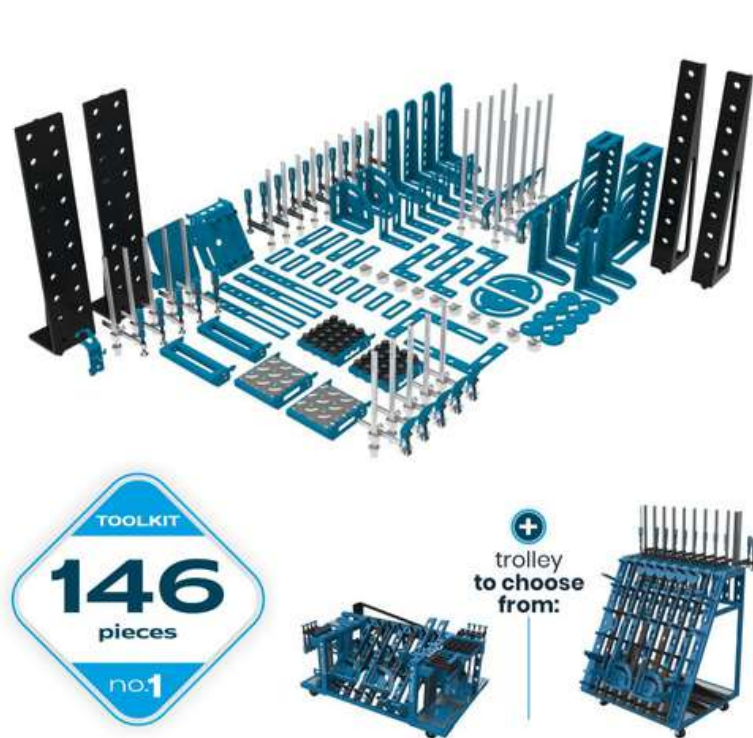

Price of toolkit no. 1 of the PRO series tool: 8 379 EUR
Price of toolkit no. 1 of the PLUS series tool: 7 389 EUR

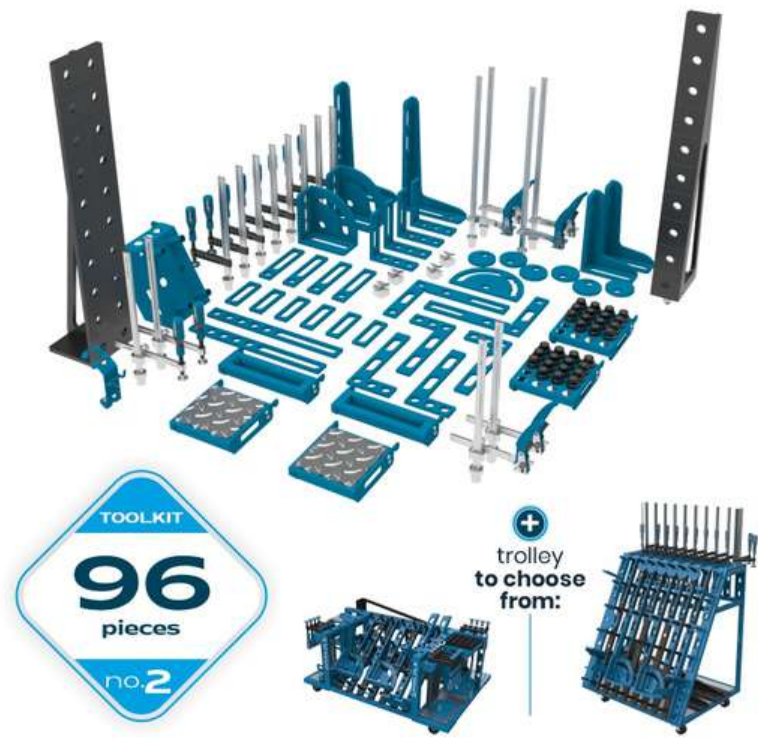

Price of toolkit no. 2 of the PRO series tool: 5 129 EUR
Price of toolkit no. 2 of the PLUS series tool: 4 589 EUR



Price of toolkit no. 3 of the PRO series tool: 2 539 EUR
Price of toolkit no. 3 of the PLUS series tool: 2 229 EUR

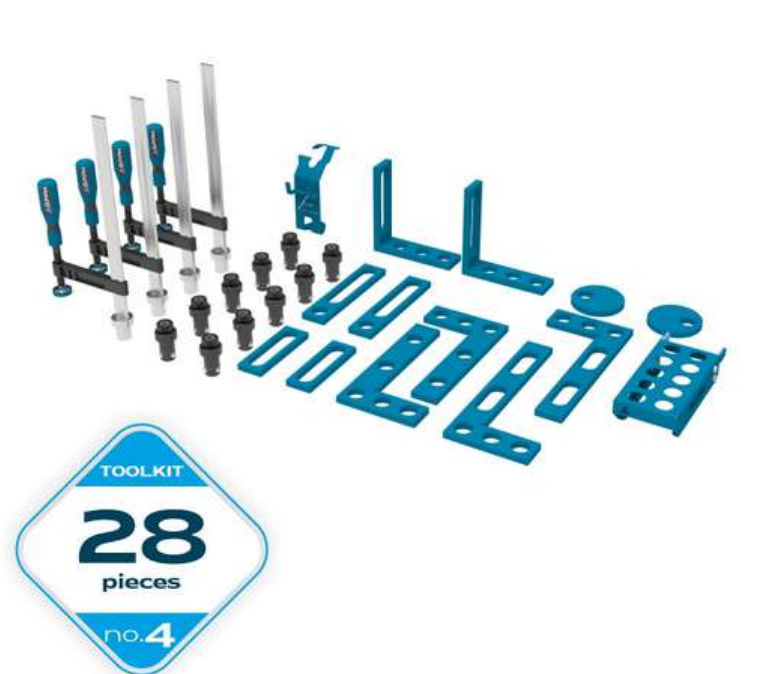

Price of toolkit no. 4 of the PRO series tool: 1 031 EUR
Price of toolkit no. 4 of the PLUS series tool: 899 EUR

*all tools are available in the version Ø 16 mm and Ø 28 mm.

**in the case of sets with tools from the PLUS series, depending on the thickness of the tabletop, the fast assembly bolt included in the set changes - in the case of PLUS, BASIC, and XWT tables with PLUS series top, it is the Fast assembly bolt 23 PLUS, and in the case of ECO, DIY, XWT tables with ECO series top and SOG stations, it is fast assembly bolt 19-22 ECO/PLUS.

TOOLKITS

each toolkit is available in the PRO and PLUS series tool**

Number of tools included in the set				
Tool	Toolkit no. 1	Toolkit no. 2	Toolkit no. 3	Toolkit no. 4
Fastening clamp	10	8	8	4
Fastening clamp with lever	10	4	2	-
Variable throat depth clamp	5	2	-	-
Variable throatdepth with lever clamp	5	2	-	-
Fast assembly bolt	40	30	18	10
Eccentric stop Ø100	8	6	4	2
Stop 150	8	6	4	2
Stop 225	4	4	4	2
Stop 500	4	2	-	-
Protractor	2	1	1	-
Angle precision square (flat) 275x150	-	-	-	2
Angle precision square (flat) 320x150	4	4	2	2
Angle precision square (flat) 350x250	2	2	2	-
Angle bracket 185x175	8	4	4	2
Angle bracket 200x200	2	2	2	-
Angle bracket 300x190	4	2	2	-
Angle bracket 450x250	4	2	1	-
Angle bracket 275x500x175x100	2	-	-	-
Table extension 1000x100	2	1	-	-
Table extension 1000x200	2	1	-	-
Welding torch handle	1	1	1	1
Prism Ø58mm 130°	10	-	-	-
Prism Ø58mm 130°/90°	-	4	2	-
Tool trolley (versions to choose: M or L)	1	1	-	-
Fast assembly bolt shelf S	-	-	-	1
Fast assembly bolt shelf M	2	2	1	-
Clamp shelf M	2	2	1	-
Flat shelf M	2	2	1	-
MIX shelf	1	1	-	-
Documentation shelf	1	-	-	-
The total number of tools included in the set	146	96	60	28



OFFICIAL DISTRIBUTOR
GLOMACHT BV



+31 / 6 8722 7638



sales@glomacht.com



Rotterdam, NL

www.GLOMACHT.com