

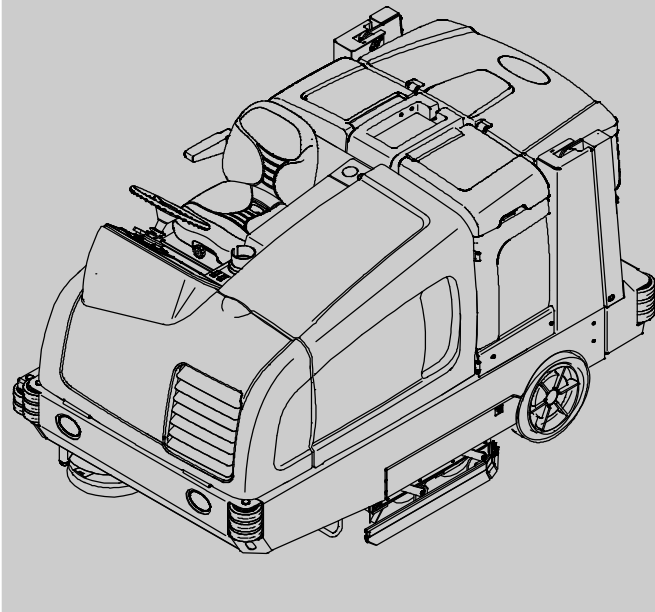

# M30

(Gas/LPG)



## Scrubber-Sweeper Operator Manual



**The Safe Scrubbing Alternative<sup>®</sup>**

**ES<sup>®</sup> Extended Scrub System**

**TennantTrue<sup>®</sup> Parts**

**Hygenic<sup>®</sup> Fully Cleanable Tanks**

**FloorSmart<sup>®</sup> Integrated Cleaning System**

**IRIS<sup>®</sup> a Tennant Technology**



## North America / International



For the latest Parts manuals and other  
language Operator manuals, visit:

[www.tennantco.com/manuals](http://www.tennantco.com/manuals)

**9003943**  
**Rev. 13 (5-2016)**



## INTRODUCTION

This manual is furnished with each new model. It provides necessary operation and maintenance instructions.



**Read this manual completely and understand the machine before operating or servicing it.**

This machine will provide excellent service. However, the best results will be obtained at minimum costs if:

- The machine is operated with reasonable care.
- The machine is maintained regularly - per the machine maintenance instructions provided.
- The machine is maintained with manufacturer supplied or equivalent parts.

### PROTECT THE ENVIRONMENT



Please dispose of packaging materials, used components such as batteries and fluids in an environmentally safe way according to local waste disposal regulations.



Always remember to recycle.

### MACHINE DATA

Please fill out at time of installation for future reference.

Model No. – \_\_\_\_\_

Serial No. – \_\_\_\_\_

Installation Date – \_\_\_\_\_

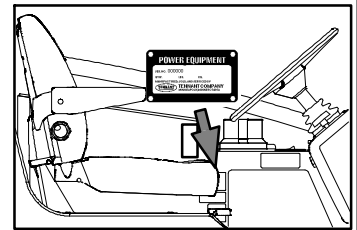

## INTENDED USE

The M30 is an industrial rider machine designed to sweep/scrub hard surfaces (concrete, asphalt, stone, synthetic, etc). Typical applications include industrial warehouses, manufacturing facilities, distribution facilities, stadiums, arenas, convention centers, parking facilities, transportation terminals, and construction sites. Do not use this machine on soil, grass, artificial turf, or carpeted surfaces. This machine can be used both indoors and outdoors, but ensure there is adequate ventilation if used indoors. This machine is not intended for use on public roadways. Do not use this machine other than described in this Operator Manual.

### Tennant Company

PO Box 1452

Minneapolis, MN 55440

Phone: (800) 553-8033 or (763) 513-2850

www.tennantco.com



### CALIFORNIA PROPOSITION 65 WARNING:

**Engine exhaust from this product contains chemicals known to the State of California to cause cancer, birth defects, or other reproductive harm.**

Thermo-Sentry, Touch-N-Go, 1-STEP, Clean-Wedge, Variable Drain Valve, EasyOpen, Grip-n-Go, MaxPro, Dura-Track, SmartRelease, InstantAccess, Duramer, FaST-PAK, ErgoSpace, Insta-Fit, and Lower Total Cost of Ownership are trademarks of Tennant Company.

Specifications and parts are subject to change without notice.

Copyright © 2008-2012, 2014, 2015, 2016 TENNANT Company, Printed in U.S.A.

**CONTENTS**

	Page		Page
Important Safety Instructions –		Scrubbing .....	25
Save These Instructions .....	3	Double Scrubbing .....	26
<b>Operation</b> .....	7	Water Pickup Mode (No Scrubbing) .....	27
Machine Components .....	7	Sweeping .....	27
Controls And Instruments .....	8	Emptying The Hopper .....	29
Touch Panel .....	9	Engaging Hopper Support Pin .....	30
Symbol Definitions .....	10	Disengaging Hopper Support Pin .....	30
Operation Of Controls .....	11	Removing The Hopper Dust Filter .....	31
Charging System Indicator .....	11	Cleaning The Hopper And Debris Screen .	32
Engine Oil Pressure Indicator .....	11	Draining And Cleaning The Recovery Tank	34
Check Engine Indicator .....	11	Draining The Recovery Tank With	
Parking Brake Indicator (Option) .....	11	The Drain Hose .....	34
Setting The Engine Speed .....	12	Draining The Recovery Tank With The	
Side Brush (Option) .....	12	Drain Plug .....	35
Fuel Indicator .....	12	Draining And Cleaning The Solution Tank .	37
Gasoline Machines .....	12	Fault Indicator(S) .....	39
Lpg Machines .....	12	Conditions / Warnings .....	40
Hour Meter .....	13	Options .....	41
Supervisor Control Buttons .....	13	Spray Nozzle (Option) .....	41
Operating Lights .....	13	Vacuum Wand (Option) .....	42
Hazard Light (Option) .....	13	High Pressure Washer (Option) .....	43
Operator Seat .....	14	Machine Troubleshooting .....	45
Seat Belts .....	14	<b>Maintenance</b> .....	47
Steering Column Tilt Knob .....	15	Maintenance Chart .....	48
Brake Pedal .....	15	Lubrication .....	51
Parking Brake Pedal .....	15	Engine Oil .....	51
Directional Pedal .....	15	Squeegee Caster Bearings .....	51
Squeegee Protectors (Option) .....	15	Front Wheel Support Bearing .....	51
How The Machine Works .....	16	Steering Cylinder Bearing .....	51
Brush Information .....	17	Rear Wheel Bearings .....	51
While Operating The Machine .....	17	Hopper Lift Arm Pivots .....	52
Pre-Operation Checklist .....	18	Hopper Door Pivots .....	52
Changing The Lpg Tank .....	19	Torque Tubes .....	52
Starting The Machine .....	20	Hydraulics .....	53
Turning Off The Machine .....	20	Hydraulic Fluid .....	54
Filling The Solution Tank .....	21	Hydraulic Hoses .....	54
Foam Scrubbing (Fast Mode) / Ec-H2o		Engine .....	55
Scrubbing (Ec-H2o Mode) .....	21	Cooling System .....	55
Conventional Scrubbing Mode .....	21	Air Filter .....	55
Es (Extended Scrub) Mode With		Fuel Filter (Lpg) .....	56
Auto-Fill .....	22	Fuel Filter (Gasoline) .....	56
Es (Extended Scrub) Mode –		Electronic Pressure Regulator (Lpg)	
Manually Filling Tanks .....	22	(S/N 000000 – 003999) .....	56
Setting Scrub Modes .....	23	Lpg Vaporizer .....	56
Setting Fast Mode .....	23	Engine Belt .....	57
Setting Es (Extended Scrub) Mode .....	23	Pcv System .....	57
Setting Ec-H2o Mode .....	23	Spark Plugs – Gm Engines	
Setting Brush Pressure .....	24	(S/N 000000 – 003999) .....	57
Setting Solution Flow .....	24	Spark Plugs – Mitsubishi Engines	
Conventional, Fast, And Ec-H2o		(S/N 004000 – ) .....	57
Solution Flow .....	24	Timing Belt – Gm Engines	
Es (Extended Scrub) Solution Flow ...	24	(S/N 000000 – 003999) .....	58
		Camshaft And Balance Shaft Belts –	
		Mitsubishi Engines (S/N 004000 – )	58

# CONTENTS

	Page		Page
Battery	58	<b>Specifications</b>	85
Fuses And Relays	58	General Machine Dimensions/Capacities	85
Relay Panel Fuses And Relays	58	General Machine Performance	85
Engine Harness Fuses And Relays	59	Hydraulic System	85
Optional Relays	59	Power Type	86
Circuit Breakers (Ec-H2o)	59	Tires	87
Cleaning The Hopper Dust Filter	60	Steering	87
Thermo-Sentry	60	Fast System	88
Main Brushes	61	Ec-H2o System	88
Replacing Or Rotating The		Machine Dimensions	89
Main Brushes	61		
Checking The Main Brush Pattern	63		
Adjusting The Main Brush Taper	64		
Adjusting The Main Brush Width	64		
Side Brush (Option)	65		
Replacing The Side Brush	65		
Fast System	66		
Replacing The Fast-Pak Carton	66		
Cleaning The Fast Supply Hose			
Connector	66		
Cleaning The Fast System Filter Screen	66		
Replacing The Fast System Filters	67		
Ec-H2o Module Flush Procedure	67		
Cleaning The Ec-H2o Filter Screen	68		
Squeegee Blades	69		
Replacing (Or Rotating) The			
Rear Squeegee Blades	69		
Replacing Or Rotating The Side			
Squeegee Blades	71		
Replacing The Side Brush Squeegee Blade			
(S/N 000000-001278) (Option)	73		
Replacing Or Adjusting The Side Brush			
Squeegee Blade (S/N 001279-			
) (Option)	74		
Leveling The Rear Squeegee	75		
Adjusting The Rear Squeegee Blade			
Deflection	76		
Skirts And Seals	77		
Scrub Head Skirt	77		
Recovery Tank Seal	77		
Solution Tank Seals	77		
Brakes And Tires	78		
Brakes	78		
Tires	78		
Front Wheel	78		
Propelling Motor	78		
Pushing, Towing, And Transporting			
The Machine	79		
Pushing Or Towing The Machine	79		
Transporting The Machine	79		
Machine Jacking	81		
Storage Information	81		
Freeze Protection (Machines Without			
Ec-H2o System)	82		
Freeze Protection (Machines With			
Ec-H2o System)	82		
Priming The Ec-H2o System	84		

## IMPORTANT SAFETY INSTRUCTIONS – SAVE THESE INSTRUCTIONS

The following precautions are used throughout this manual as indicated in their description:

 **WARNING:** To warn of hazards or unsafe practices that could result in severe personal injury or death.

 **CAUTION:** To warn of unsafe practices that could result in minor or moderate personal injury.

**FOR SAFETY:** To identify actions that must be followed for safe operation of equipment.

The following information signals potentially dangerous conditions to the operator. Know when these conditions can exist. Locate all safety devices on the machine. Report machine damage or faulty operation immediately.

 **WARNING:** Flammable materials can cause an explosion or fire. Do not use flammable materials in tank.

 **WARNING:** Flammable materials or reactive metals can cause an explosion or fire. Do not pickup.

 **WARNING:** Moving belt and fan. Keep away.

 **WARNING:** Engine emits toxic gases. Serious injury or death can result. Provide adequate ventilation.

 **WARNING:** Raised hopper may fall. Engage hopper support pin.

 **WARNING:** Lift arm pinch point. Stay clear of hopper lift arms.

 **WARNING:** Burn hazard. Hot surface. Do NOT touch.

 **WARNING:** Do not spray people or animals. Severe personal injury can result. Wear eye protection. Hold sprayer with two hands.

 **CAUTION:** LPG engine will run for a few seconds after key is turned off. Apply parking brake before leaving machine.

**WARNING:** This machine contains chemicals known to the State of California to cause cancer, birth defects, or other reproductive harm.

This machine may be equipped with technology that automatically communicates over the cellular network. If this machine will be operated where cell phone use is restricted because of concerns related to equipment interference, please contact a Tennant representative for information on how to disable the cellular communication functionality.

**FOR SAFETY:**

1. **Do not operate machine:**
  - Unless trained and authorized.
  - Unless operator manual is read and understood.
  - Unless mentally and physically capable of following machine instructions.
  - If it is not in proper operating condition.
  - In areas where flammable vapors/liquids or combustible dusts are present.
  - In areas that are too dark to safely see the controls or operate the machine unless operating / headlights are turned on.
  - In areas with possible falling objects unless equipped with overhead guard.
2. **Before starting machine:**
  - Check for fuel, oil, and liquid leaks.
  - Keep sparks and open flame away from refueling area.
  - Make sure all safety devices are in place and operate properly.
  - Check brakes and steering for proper operation.
  - Adjust seat and fasten seat belt.
3. **When starting machine:**
  - Keep foot on brake and directional pedal in neutral.

## SAFETY PRECAUTIONS

### 4. When using machine:

- Use only as described in this manual.
- Do not pick up burning or smoking debris, such as cigarettes, matches or hot ashes
- Use brakes to stop machine.
- Go slowly on inclines and slippery surfaces.
- Reduce speed when turning.
- Keep all parts of body inside operator station while machine is moving.
- Use care when reversing machine.
- Move machine with care when hopper is raised.
- Make sure adequate clearance is available before raising hopper.
- Do not raise hopper when machine is on an incline.
- Never allow children to play on or around machine.
- Do not carry passengers on machine.
- Always follow safety and traffic rules.
- Report machine damage or faulty operation immediately.
- Follow mixing, handling and disposal instructions on chemical containers.
- Follow safety guidelines concerning wet floors.

### 5. Before leaving or servicing machine:

- Do not park near combustible materials, dusts, gases, or liquids.
- Stop on level surface.
- Set parking brake.
- Turn off machine and remove key.

### 6. When servicing machine:

- All work must be done with sufficient lighting and visibility.
- Avoid moving parts. Do not wear loose clothing, jewelry and secure long hair.
- Block machine tires before jacking machine up.
- Jack machine up at designated locations only. Support machine with jack stands.
- Use hoist or jack that will support the weight of the machine.
- Do not power spray or hose off machine near electrical components.
- Disconnect battery connections before working on machine.
- Avoid contact with battery acid.
- Avoid contact with hot engine coolant.
- Do not remove cap from radiator when engine is hot.
- Allow engine to cool.
- Keep flames and sparks away from fuel system service area. Keep area well ventilated.

- Use cardboard to locate leaking hydraulic fluid under pressure.
- All repairs must be performed by a trained service mechanic.
- Do not modify the machine from its original design.
- Use Tennant supplied or approved replacement parts.
- Wear personal protective equipment as needed and where recommended in this manual.



For Safety: wear hearing protection.



For Safety: wear protective gloves.



For Safety: wear eye protection.



For Safety: wear protective dust mask.

### 7. When loading/unloading machine onto/off truck or trailer:

- Drain tanks before loading machine.
- Lower scrub head and squeegee before tying down machine.
- Empty debris hopper before loading machine.
- Turn off machine and remove key.
- Use ramp, truck or trailer that will support the weight of the machine and operator.
- Use winch. Do not drive the machine onto/off the truck or trailer unless the load height is 380 mm (15 in) or less from the ground.
- Set parking brake after machine is loaded.
- Block machine tires.
- Tie machine down to truck or trailer.

The following safety labels are mounted on the machine in the locations indicated. If these or any labels become damaged or illegible, install a new label in its place.

## EMISSIONS LABEL – Located on the side of the operator compartment.

	<b>▲ WARNING</b>	<b>▲ AVERTISSEMENT</b>	<b>▲ ADVERTENCIA</b>
	Machine emits toxic gases. Serious injury or death can result. Provide adequate ventilation.	La machine produit des gaz toxiques. Ces gaz peuvent provoquer des blessures ou la mort. Veillez à ce que l'endroit soit bien aéré.	La máquina emite gases tóxicos. Pueden provocar lesiones graves o fatales. Asegúrese de que existe suficiente ventilación.
	25971		

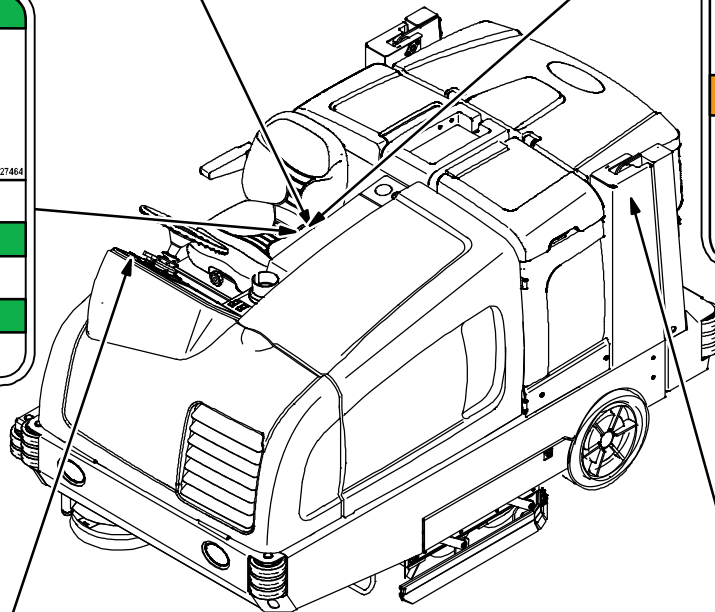

## FOR SAFETY LABEL – Located on the side of the operator compartment.

<b>FOR SAFETY</b>

27484
Read manual before operating machine.
<b>POUR VOTRE SECURITE</b>
Lisez le manuel avant d'utiliser la machine.
<b>PARA SEGURIDAD</b>
Lea el manual antes de operar la máquina.



## FLAMMABLE SPILLS LABEL – Located on the side of the operator compartment.

<b>▲ WARNING</b>

11535
Flammable materials or reactive metals can cause explosion or fire. Do not pick up.
<b>▲ AVERTISSEMENT</b>
Les matériaux inflammables ou les métaux réactifs peuvent causer une explosion ou un incendie. Ne les ramassez pas.
<b>▲ ADVERTENCIA</b>
Los materiales inflamables o metales reactivos pueden causar explosiones o incendios. No los recoja.

<b>▲ CAUTION</b>	<b>▲ ATTENTION</b>	<b>▲ ATENCIÓN</b>
		
LPG engine will run for a few seconds after key is turned off. Apply parking brake before leaving machine.	Le moteur à GPL tourne encore quelques secondes une fois le contact coupé. Engagez le frein de stationnement avant de quitter la machine.	El motor LPG seguirá funcionando algunos segundos después de retirar la llave de contacto. Aplique el freno de estacionamiento antes de abandonar la máquina.
1920434		

## LPG ENGINE LABEL – Located next to the ignition switch on the instrument panel. (LPG machines only)

<b>▲ WARNING</b>

56781
Lift arm pinch point. Stay clear of hopper lift arms.
<b>▲ AVERTISSEMENT</b>
Attention au point d'articulation du bras d'élévation. Ne vous approchez pas des bras d'élévation de la trémie.
<b>▲ ADVERTENCIA</b>
Punto de pinzamiento del brazo elevador. No se acerque a los brazos elevadores de la caja colectora.

## HOPPER LIFT ARMS LABEL – Located on both hopper lift arms.

# SAFETY PRECAUTIONS

**FAN AND BELT LABEL –**  
Located on engine compartment panel.

<b>▲ WARNING</b>



Moving belt and fan. Keep away.
<b>▲ AVERTISSEMENT</b>
La courroie et le ventilateur sont en mouvement. Ne vous approchez pas.
<b>▲ ADVERTENCIA</b>
Correa y ventilador en movimiento. Manténgase alejado.

**HIGH PRESSURE SPRAY HAZARD LABEL –** Located on frame of machine.

<b>▲ WARNING</b>

Do not spray people or animals. Severe personal injury can result. Wear eye protection. Hold sprayer with two hands.
<b>▲ AVERTISSEMENT</b>
N'aspérez pas les personnes ou les animaux. Vous pourriez occasionner de graves blessures. Portez une protection oculaire. Tenez le pulvérisateur à deux mains.
<b>▲ ADVERTENCIA</b>
No pulverizar sobre personas o animales. Pueden producirse lesiones graves. Utilice protección ocular. Sujete el pulverizador con ambas manos.

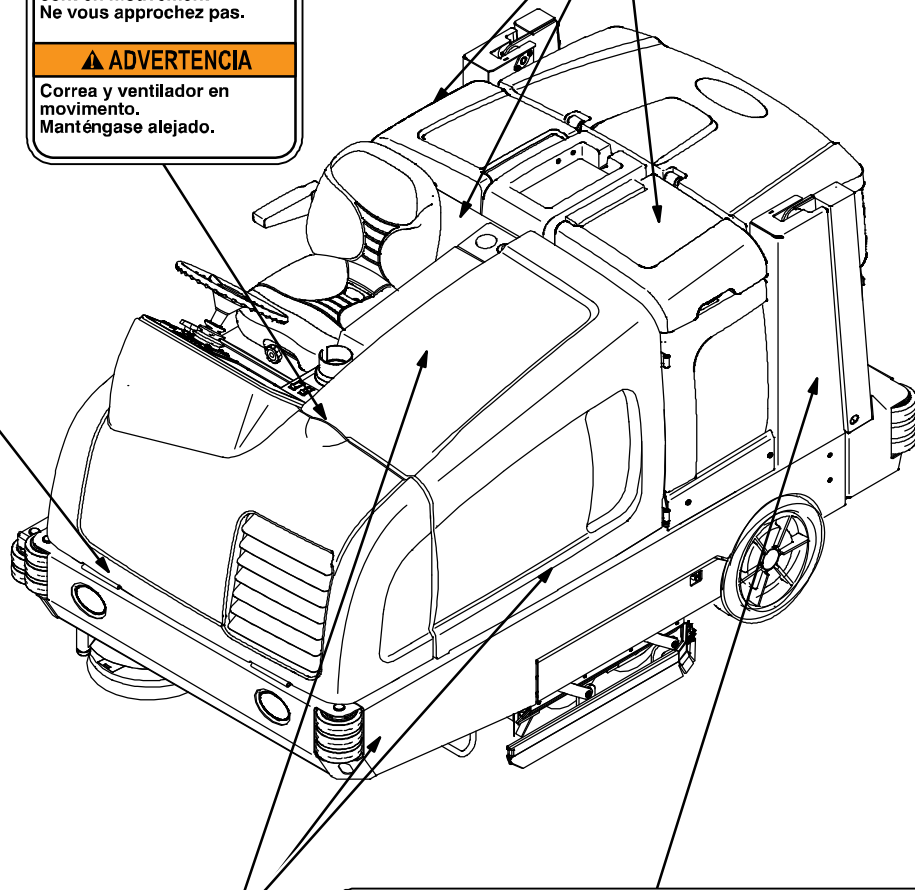

**FLAMMABLE MATERIALS LABEL –**  
Located next to the solution tank covers and on the detergent tank.

	<b>▲ WARNING</b>	<b>▲ AVERTISSEMENT</b>	<b>▲ ADVERTENCIA</b>
	Flammable materials can cause explosion or fire. Do not use flammable materials in tank.	Les matières inflammables peuvent causer une explosion ou un incendie. N'utilisez pas de matières inflammables dans le(s) réservoir(s).	Los materiales inflamables pueden provocar explosiones o incendios. No utilice materiales inflamables en el depósito(s).
			



	<b>▲ WARNING</b>
	Burn hazard. Hot surface. Do NOT touch.
	<b>▲ AVERTISSEMENT</b>
	Risque de brûlures. Surface chaude. Ne pas toucher.
	<b>▲ ADVERTENCIA</b>
	Peligro de quemaduras. Superficie caliente. NO tocar.

**HOT SURFACE LABEL –** Located on the side of the bumper, on the exhaust shield, and on the hydraulic reservoir.

	<b>▲ WARNING</b>	<b>▲ AVERTISSEMENT</b>	<b>▲ ADVERTENCIA</b>
	Raised hopper may fall. Engage hopper support pin.	En position relevée, le bac à déchets peut retomber. Engagez la broche du support de bac à déchets.	La caja colectora elevada puede caer. Coloque el pasador de apoyo de la caja colectora.

**RAISED HOPPER LABEL –** Located on both hopper lift arms.



## OPERATION

## MACHINE COMPONENTS

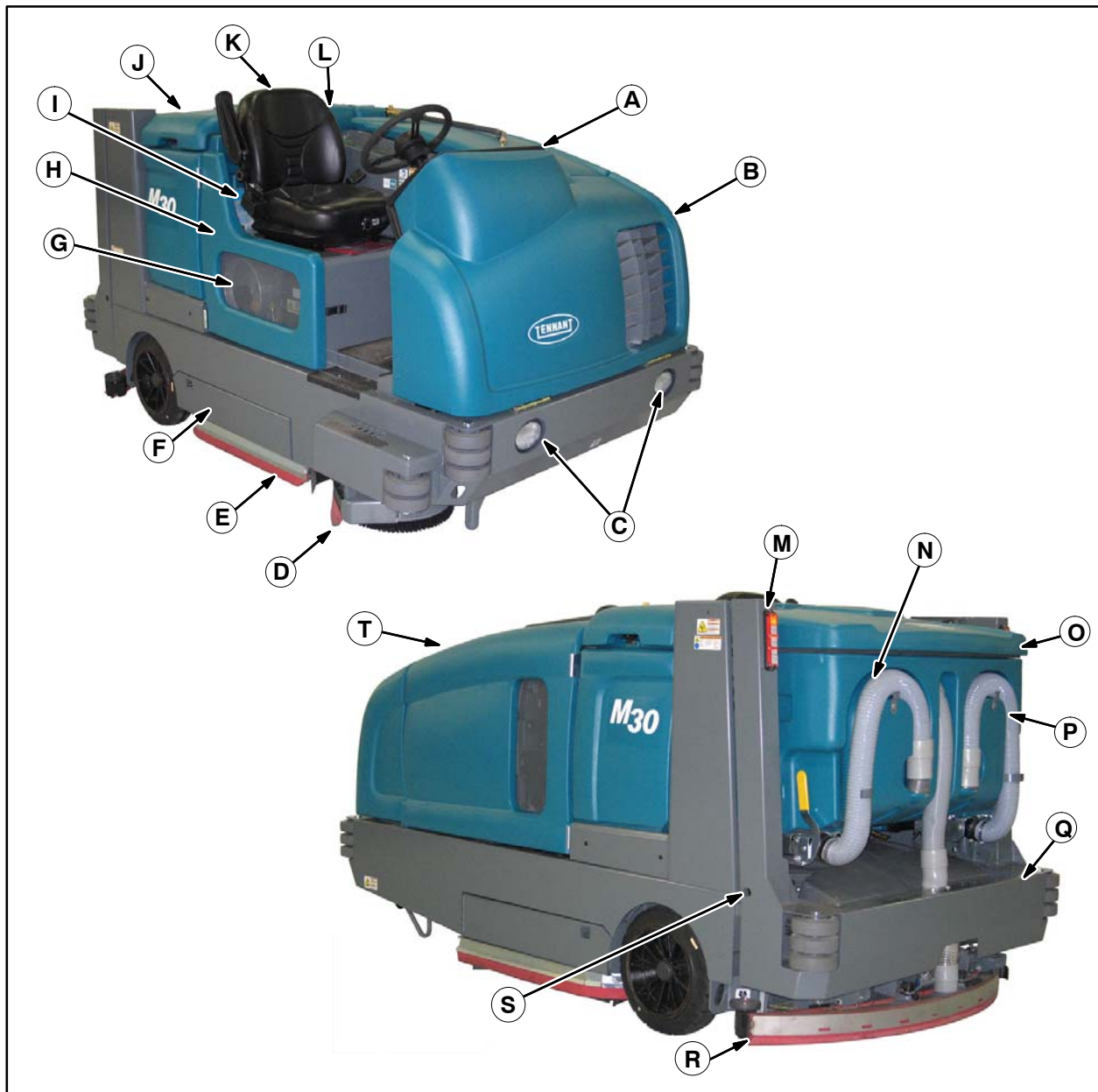

- A. Instrument panel
- B. Front shroud
- C. Headlights
- D. Side brush (option)
- E. Side squeegee
- F. Scrub head access door
- G. Fuel tank
- H. Seat shroud
- I. FaST carton, or ES detergent tank, or ec-H<sub>2</sub>O System Module compartment (option)
- J. Solution tank cover

- K. Operator seat
- L. Spray wand – nozzle behind seat (option)
- M. Taillights
- N. Recovery tank drain hose
- O. Recovery tank cover
- P. Solution tank drain hose
- Q. Hopper
- R. Rear squeegee
- S. Hopper safety pin
- T. Engine cover

# OPERATION

## CONTROLS AND INSTRUMENTS

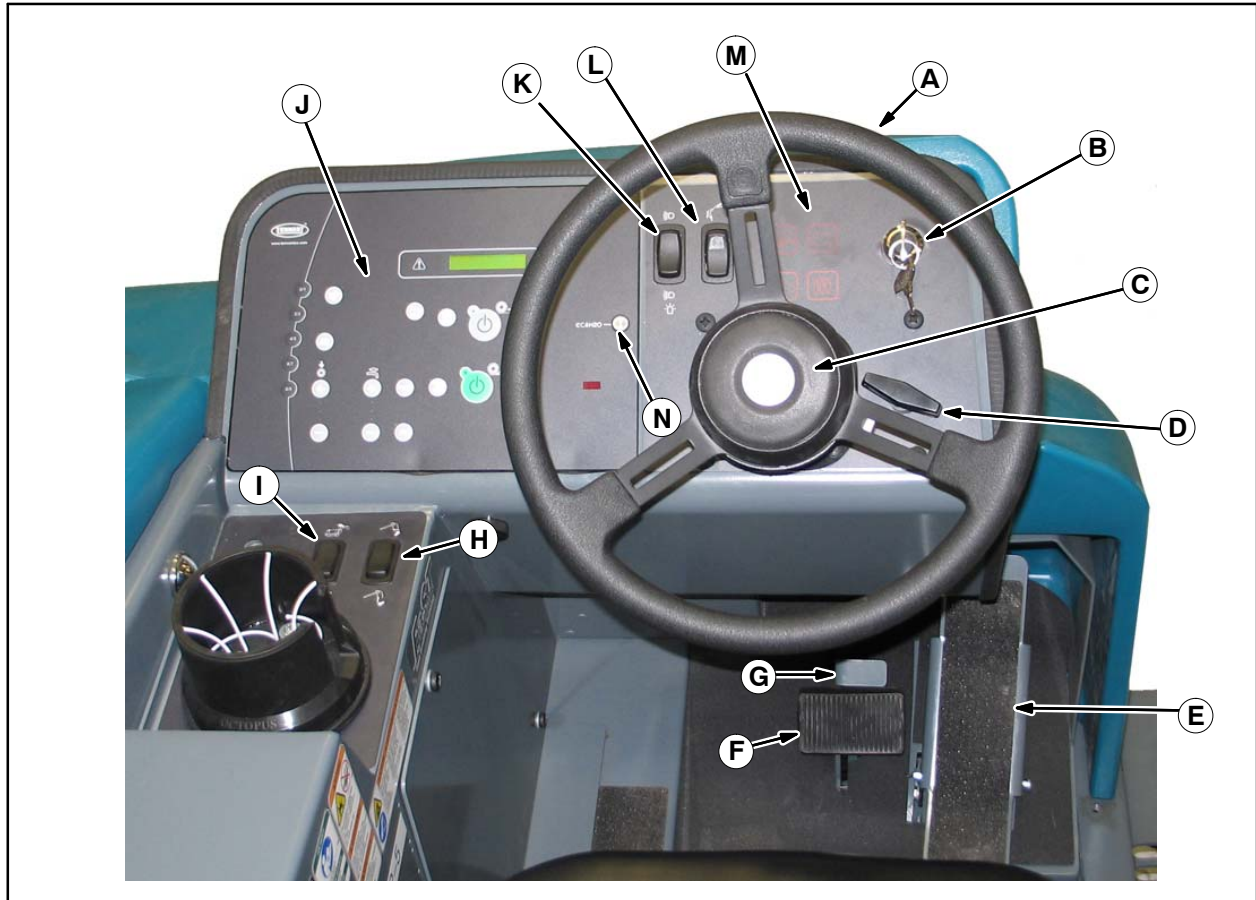

- A. Steering wheel
- B. Ignition switch
- C. Horn button
- D. Steering column tilt knob
- E. Directional pedal
- F. Brake pedal
- G. Parking brake pedal
- H. Hopper door open / close switch
- I. Hopper raise / lower switch
- J. Touch panel
- K. Operating / Hazard Lights switch
- L. Spray nozzle switch (option)
- M. Engine indicator lights
- N. *ec-H2O* system indicator light (option)

## TOUCH PANEL

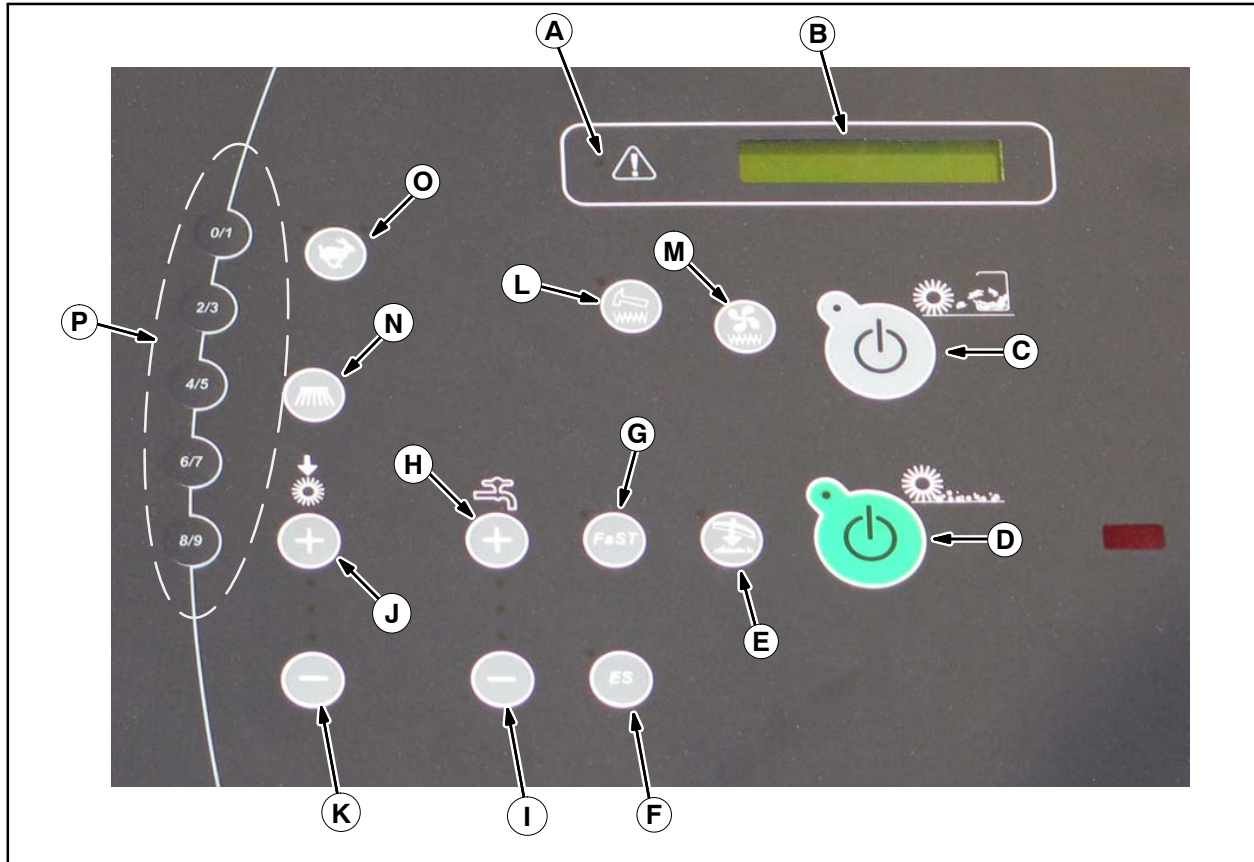































- A. Fault indicator light
- B. Hour meter / fuel indicator / fault code indicator
- C. 1-STEP sweep button
- D. 1-STEP scrub button
- E. Scrub vacuum fan / squeegee button
- F. ES (Extended Scrub) button (option)
- G. FaST button (option)
- ec-H2O button (option)
- H. Solution increase button (+)
- I. Solution decrease button (-)
- J. Brush pressure increase button (+)
- K. Brush pressure decrease button (-)
- L. Filter shaker button
- M. Sweep vacuum fan button
- N. Side brush button (option)
- O. Engine speed button
- P. Supervisor control buttons

# OPERATION

## SYMBOL DEFINITIONS

These symbols are used on the machine to identify controls, displays, and features.

	Hazard light		Engine speed
	Operating lights		Side brush
	Spray nozzle		Main brush pressure
	Hopper door open		Solution flow
	Hopper door close		Increase
	Hopper raise		Decrease
	Hopper lower		Charging system
	Fault indicator		Engine oil pressure (000000-001138)
	Filter shaker		Engine oil pressure (001139- )
	Sweep vac fan		Check engine
	Scrub vac fan/squeegee		Parking Brake (001139- )
	1-STEP sweep		Horn
	1-STEP scrub		Jack point
	ES (extended scrub)		Unleaded fuel only
	FaST (foam scrubbing)		ec-H2O (option)

**OPERATION OF CONTROLS**

**CHARGING SYSTEM INDICATOR**

The *Charging system indicator* comes on when the alternator is not operating within the normal range. If this indicator comes on, stop the machine immediately and correct the problem.

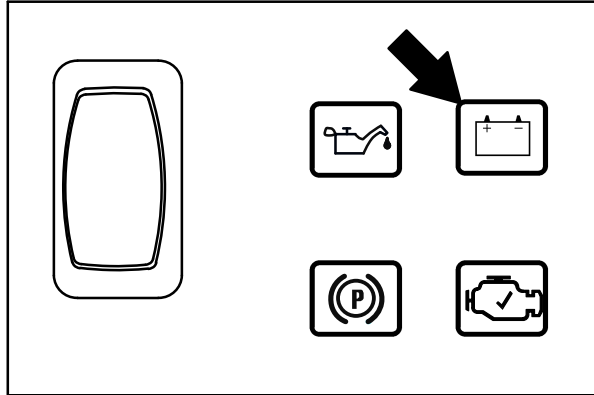

**ENGINE OIL PRESSURE INDICATOR**

The *Engine oil pressure indicator* comes on when the engine oil pressure falls below the normal operating pressure. If this indicator comes on, stop the machine immediately and correct the problem.

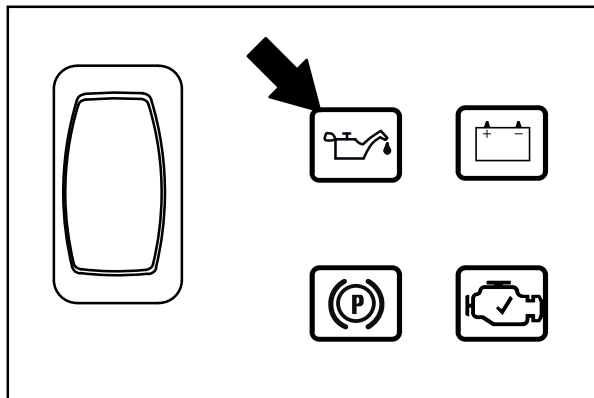

**CHECK ENGINE INDICATOR**

The *Check engine indicator* comes on when the engine control system detects a fault during machine operation.

If this indicator comes on, contact a Tennant service representative.

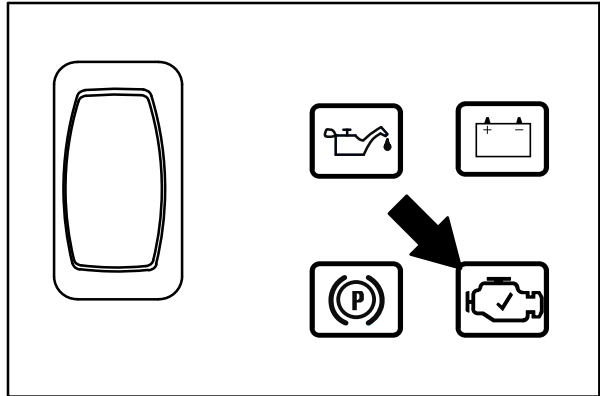

**PARKING BRAKE INDICATOR (OPTION)**

The *parking brake indicator* comes on when the parking brake is engaged.

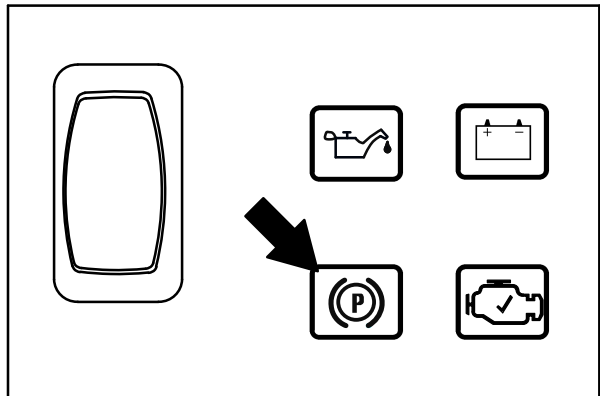



# OPERATION

## SETTING THE ENGINE SPEED

The engine speed is controlled automatically when either the *1-STEP Scrub button* or *1-STEP Sweep button* is pressed. When not sweeping or scrubbing, press the *Engine Speed button* to increase the engine RPM for increased travel speed. Press the *Engine Speed button* again to reduce the engine RPM. The two lights above the button indicate engine speed setting. When one light is lit the engine is in the low setting. When two lights are lit the engine is in the high setting.

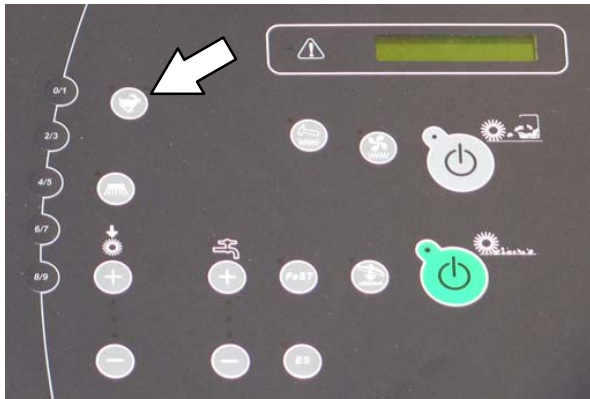

## FUEL INDICATOR

### GASOLINE MACHINES

For gasoline machines, the *Fuel indicator* displays the amount of fuel left in the tank. The fault indicator will flash and a low fuel message will appear when the tank is near empty.

*NOTE: Do not use leaded fuels. Leaded fuels will permanently damage the system oxygen sensor and catalytic converter.*

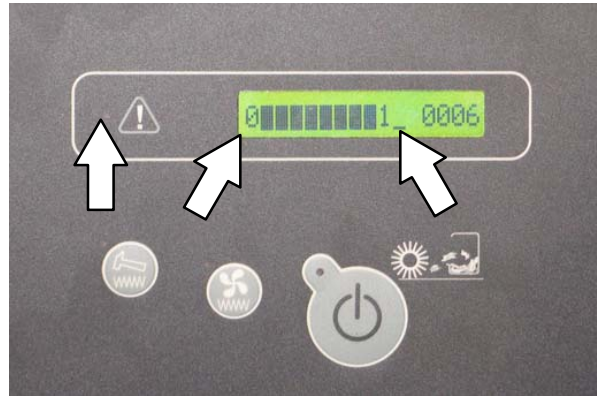

## SIDE BRUSH (OPTION)

The side brush allows users to sweep or scrub difficult to reach corners and areas near walls. The side brush also widens the scrubbing/ sweeping path.

With the *1-STEP Scrub button* or *1-STEP Sweep button* activated, press the *Side brush button* to lower and start the side brush. The light next to the button will come on. When finished using the side brush, press the button again to raise and stop the side brush. The light next to the button will turn off. The machine will default to the last setting used when it is powered on or off.

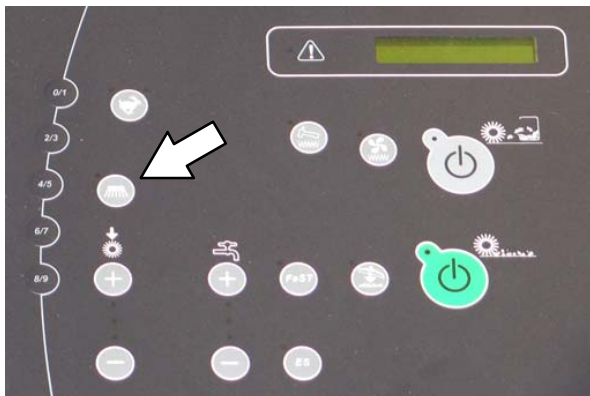

### LPG MACHINES

For LPG machines, the *Fuel indicator* does NOT display the amount of fuel in the LPG tank. It will display all the indicator bars to show that some fuel is in the tank. When the LPG tank is near empty, the fault indicator will flash and a low fuel message will appear.

The *LPG fuel gauge* on the tank displays the amount of fuel in the LPG tank.

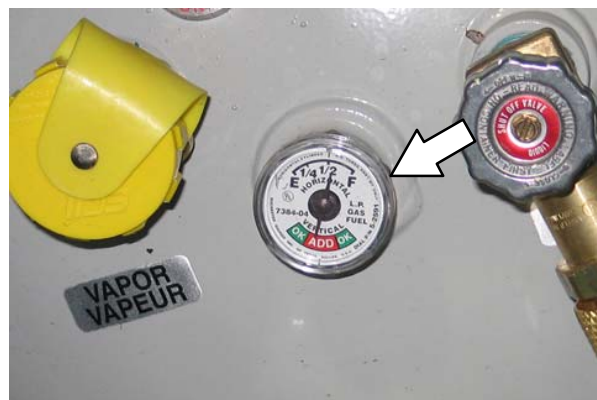

**HOURLY METER**

The *Hour meter* records the hours the machine was operated. Use this information to determine machine service intervals.

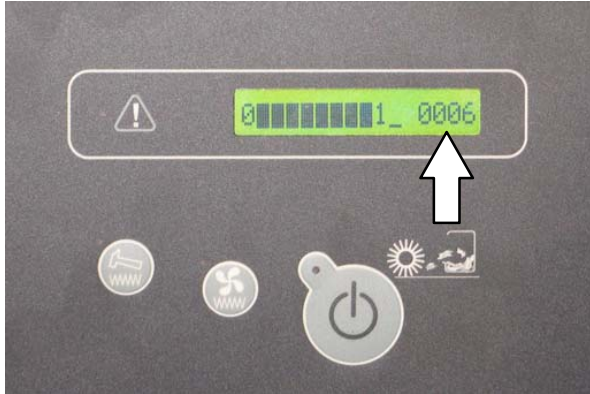

**OPERATING LIGHTS**

Push the top of the *Operating / hazard light switch* to turn on the headlights and taillights. Return the light switch to the center position to turn off the lights.



**SUPERVISOR CONTROL BUTTONS**

The *Supervisor Control buttons* are for accessing the configuration and diagnostic modes. Only properly trained service personnel and TENNANT representatives should access these modes.

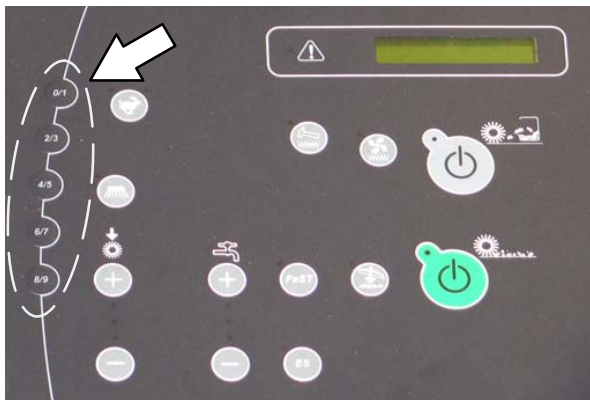

**HAZARD LIGHT (OPTION)**

Press the bottom of the *Operating / hazard light switch* to turn on the hazard light, headlights, and taillights. Return the light switch to the center position to turn off the lights.

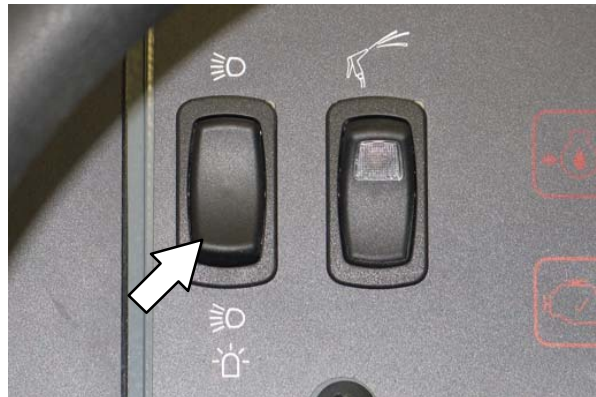

## OPERATION

### OPERATOR SEAT

The operator seat has three adjustments: backrest angle, operator weight, and front to back.

The backrest adjustment knob adjusts the angle of the backrest.



Increase angle: Turn the angle adjustment knob counterclockwise.

Decrease angle: Turn the angle adjustment knob clockwise.

The weight adjustment knob controls the firmness of the operator seat.



Increase firmness: Turn the weight adjustment knob clockwise.

Decrease firmness: Turn the weight adjustment knob counterclockwise.

Use the gauge next to the weight adjustment knob to help determine seat firmness for the operator.

The front-to-back adjustment lever adjusts the seat position.



Adjust: Pull the lever out and slide the seat to the desired position. Release the lever to lock the seat into place.

### SEAT BELTS

**FOR SAFETY: Before starting machine, adjust seat and fasten seat belt.**





**STEERING COLUMN TILT KNOB**

1. Pull the *Steering column tilt knob* and adjust the steering column to the desired height.
2. Release the *Steering column tilt handle*.



**BRAKE PEDAL**

Press the *Brake pedal* to stop the machine.



**PARKING BRAKE PEDAL**

Press the *Brake pedal* down as far as possible and use toe to lock the *Parking brake pedal* into place. Press the *Brake pedal* to release the parking brake. The *Parking brake pedal* will return to the unlocked position.



**DIRECTIONAL PEDAL**

Press the top of the *Directional pedal* to move forward and the bottom of the pedal to move backward. The backup lights will come on when the machine is in reverse. The pedal returns to the neutral position when it is released.



*NOTE: An audible alarm will sound and the backup light will flash when backing the machine if equipped with the optional backup alarm.*

**SQUEEGEE PROTECTORS (OPTION)**

The rear and side squeegee protectors help protect the rear squeegee from being damaged.

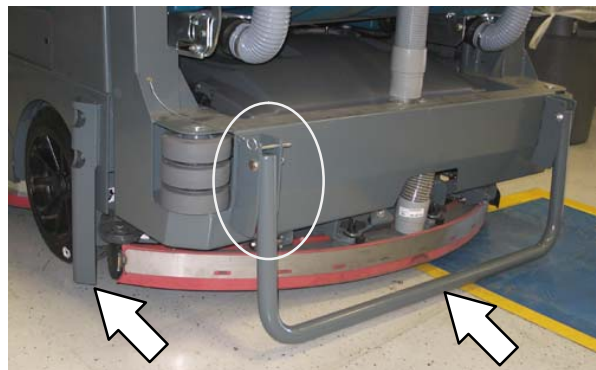

To engage the rear squeegee protector, pull the pin, lower the protector bar, and reinsert the pin.



# OPERATION

## HOW THE MACHINE WORKS

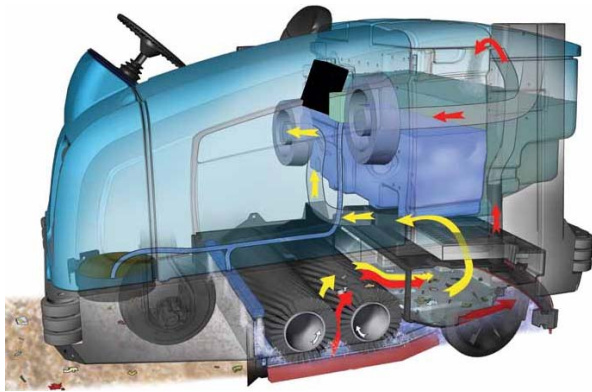

This machine can effectively scrub or sweep dirty floors. The *1-STEP Scrub button* and *1-STEP Sweep button* make it possible to immediately begin scrubbing or sweeping.

The *1-STEP Sweep button* operates all the dry sweeping functions (without scrubbing). The *1-STEP Scrub button* operates all the scrubbing functions. (The machine also sweeps while scrubbing).

When in the conventional Scrub mode, a water and detergent mixture is used to scrub the floor.

When in the optional FaST (Foam scrubbing) mode, the FaST scrubbing system mixes the FaST-PAK concentrate with a small amount of water, creating a large volume of expanded wet foam. The FaST system can be used with all double scrubbing and heavy duty scrubbing applications.



When in the optional ES (Extended Scrub) mode, the dirty solution in the recovery tank is filtered through the ES system and returned to the solution tank for reuse. Detergent is then injected into the returned solution to revitalize the cleaning capability of the solution.

When in the optional *ec-H2O* (electrically converted water) mode, normal water passes through a module where it is oxygenated and charged with an electric current. The electrically converted water changes into a blended acidic and alkaline solution forming a neutral pH cleaner. The converted water attacks the dirt, breaks it into smaller particles, and pulls it off the floor surface allowing the machine to easily scrub away the suspended soil. The converted water then returns to normal water in the recovery tank. The *ec-H2O* system can be used while double scrubbing.

---

**BRUSH INFORMATION**

---

For best results, use the correct brush type for the cleaning application. Listed below are the brushes and the applications for which each is best suited.

*NOTE: The amount and type of soilage play an important role in determining the type of brushes to use. Contact a Tennant representative for specific recommendations.*

**PolyPro brush** – Heavy duty polypropylene bristles provide a more aggressive cleaning performance and can more easily lift compacted dirt, debris, and sand while offering excellent scrubbing performance.

**Polypropylene brush** – General purpose polypropylene bristles lift lightly compacted dirt without scuffing high-gloss coated floors.

**Polyester brush** – Softer general purpose polyester bristles lift light debris while sweeping and gently clean while scrubbing. Perfect for sensitive floor surfaces. Polyester does not absorb water so it is preferred over Nylon in wet applications.

**Super AB brush** – Nylon fiber impregnated with abrasive grit to remove stains and compacted dirt. Aggressive action on any surface. Performs well on buildup, grease, or tire marks.

---

**WHILE OPERATING THE MACHINE**

---

Pick up oversized debris before scrubbing or sweeping. Pick up wire, string, twine, large pieces of wood, or any other debris that could become wrapped around or tangled in the brushes.

Drive as straight a path as possible. Avoid bumping into posts or scraping the sides of the machine. Overlap the scrub/sweep paths by several centimeters (a few inches).

Avoid turning the steering wheel too sharply when the machine is in motion. The machine is very responsive to the movement of the steering wheel. Avoid sudden turns, except in emergencies.

Adjust the machine speed, brush pressure, and solution flow as required when scrubbing. Use the lowest brush pressure and solution flow settings for best performance. If the machine is equipped with the FaST or *ec-H2O* system, use the FaST or *ec-H2O* system for the best scrubbing results.

Keep the machine moving to prevent damaging floor finishes.

If poor cleaning performance is observed, stop cleaning and refer to *MACHINE TROUBLESHOOTING* in this manual.

Perform the Daily Maintenance Procedures after each use (see *MACHINE MAINTENANCE* in this manual).

Drive the machine slowly on inclines. Use the brake pedal to control machine speed on descending inclines. Scrub with the machine up inclines rather than down inclines.

**FOR SAFETY: When using machine, go slowly on inclines and slippery surfaces.**

Do not operate machine in areas where the ambient temperature is above 43° C (110° F). Do not operate scrubbing functions in areas where the ambient temperature is below freezing 0° C (32° F).

The maximum rated incline for scrubbing with the machine is 10%. The maximum rated incline during transport of the machine is 14%.

## PRE-OPERATION CHECKLIST

- Check the hydraulic fluid level.
- Check the fuel level.
- Check the machine for fluid leaks.
- Check the condition of the main brushes. Remove string, banding, plastic wrap, or other debris wrapped around the brushes.
- Check the main brush compartment right skirts, seals, and squeegee for damage and wear.
- Side Brush Option: Check the condition of the brush. Remove string, banding, plastic wrap, or other debris wrapped around the brush.
- Side Brush Option: Check the condition of the side brush skirt or squeegee.
- Check the radiator and hydraulic cooler fins for debris.
- Check the engine coolant level.
- Check the engine oil level.
- Check the main brush compartment left skirts, seals, and squeegee for damage and wear.
- Check the left solution tank cover seal for damage and wear.
- Check the recovery tank cover seal for damage and wear.
- Clean the vacuum fan debris filter.
- Drain and clean the recovery tank.
- ES Option: Drain and clean the solution tank, float sensor, and ES filter.
- Check the right solution tank cover seal for damage and wear.
- Check the condition of the hopper dust filter and seals.
- Clean the hopper and the debris screen.
- Check the squeegee hose for debris or blockage.
- Check the squeegees for damage, wear, and deflection adjustment.
- FaST Scrubbing: Check the FaST-PAK concentrate agent level. Replace carton as needed. See the INSTALLING THE FaST-PAK CARTON section of the manual.
- FaST Scrubbing: Ensure all conventional cleaning agents are drained and rinsed from the solution tank.
- FaST Scrubbing: Ensure the solution tank is filled with **clear cool water only**.
- Check the horn, headlights, taillights, safety lights, and backup alarm (if equipped).
- Check the brakes and steering for proper operation.
- Check the service records to determine maintenance requirements.



**CHANGING THE LPG TANK**

**FOR SAFETY: Before leaving or servicing machine, stop on level surface, set parking brake, turn off machine, and remove key.**

1. Open the side access door.
2. Close the LPG tank service valve.

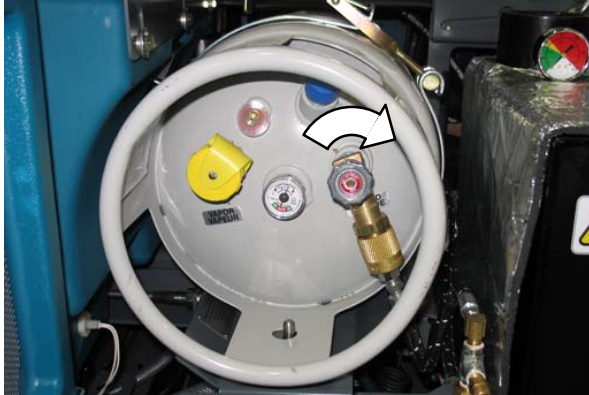

3. Start the machine and operate the engine until it stops from lack of fuel. Turn off the machine.
4. Lift the operator seat open and engage the seat latch so the seat remains open.

**FOR SAFETY: When servicing machine, keep flames and sparks away from fuel system service area. Keep area well ventilated.**

5. Put on gloves and remove the quick disconnect tank coupling.



6. Disengage the mounting strap and remove the empty LPG fuel tank.

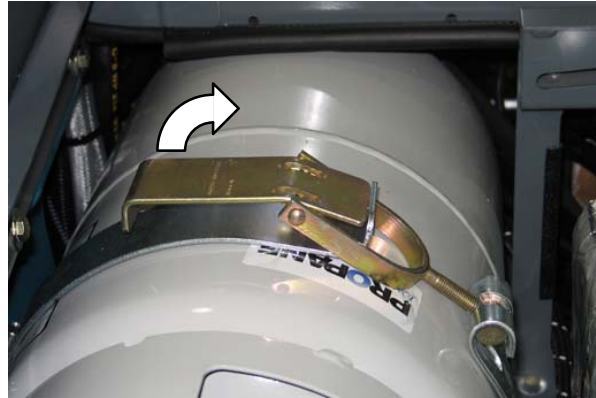

7. Align the hole in the tank collar with the centering pin and carefully place the full LPG tank onto the tray. Secure the tank with mounting strap.

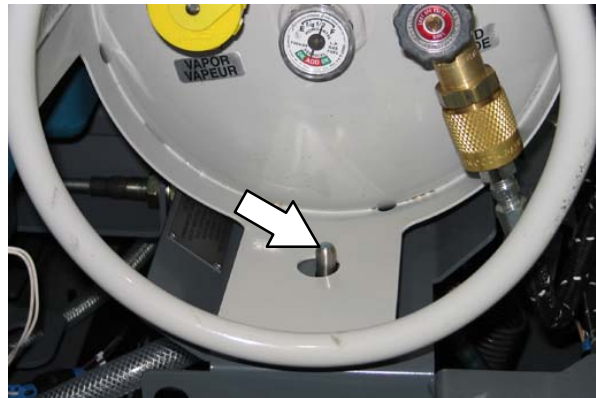

8. Connect the LPG fuel line to the tank service coupling. Make sure the tank service coupling is clean and undamaged and that it matches the fuel line coupling.
9. Slowly open the tank service valve and check for leaks. If a leak is found, immediately close the service valve and inform the appropriate personnel.

# OPERATION

## STARTING THE MACHINE

1. LPG powered machines: Slowly open the liquid service valve.

*NOTE: Opening the service valve too quickly may cause the service check valve to stop the flow of LPG fuel. If the check valve stops the fuel flow, close the service valve, wait a few seconds, and slowly open the valve again.*

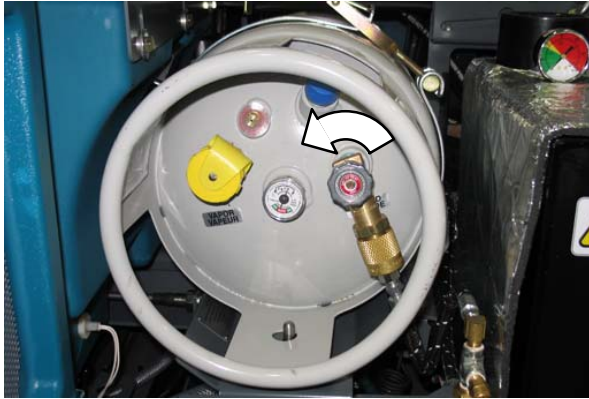

2. Sit in the operator seat and press the brake pedal or set the parking brake.

**FOR SAFETY: When starting machine, keep foot on brake and directional pedal in neutral.**

3. Turn the ignition switch key until the engine starts.



*NOTE: Do not operate the starter motor for more than 10 seconds at a time or after the engine has started. Allow the starter to cool 15–20 seconds between starting attempts or damage to the starter motor may occur.*

4. Allow the engine and hydraulic system to warm up for three to five minutes.

**WARNING: Engine emits toxic gases. Severe respiratory damage or asphyxiation can result. Provide adequate ventilation. Consult with your regulatory authorities for exposure limits. Keep engine properly tuned.**

5. Turn on lights.

## TURNING OFF THE MACHINE

1. Stop the machine and turn off all scrubbing/ sweeping functions.
2. Turn the ignition switch key counter clockwise to turn off the machine. Remain in the operator seat until the engine is off.

**CAUTION: LPG engine will run for a few seconds after key is turned off. Apply parking brake before leaving machine.**

*NOTE: To protect engine emission components on LPG powered machines, the engine will continue to operate for a few seconds after the ignition switch is turned off.*

**FOR SAFETY: Before leaving or servicing machine, do not park near combustible materials, dust, gases, or liquids. Stop on level surface, set parking brake, turn off machine, and remove key.**

## FILLING THE SOLUTION TANK

### FOAM SCRUBBING (FaST MODE) / ec-H<sub>2</sub>O SCRUBBING (ec-H<sub>2</sub>O MODE)

**FOR SAFETY: Before leaving or servicing machine, stop on level surface, set parking brake, turn off machine, and remove key.**

1. Open either the left or right solution tank fill cover.
2. Fill the solution tank with only clean COOL WATER (less than 21°C / 70°F). DO NOT use hot water or add any conventional floor cleaning detergents or FaST system failure may result.

**! WARNING: Flammable materials can cause an explosion or fire. Do not use flammable materials in tank(s).**

*NOTE: To install or change the FaST-PAK carton, see the REPLACING THE FaST-PAK CARTON section of the manual.*



*NOTE: Do not use the FaST or ec-H<sub>2</sub>O system when there are conventional cleaning detergents in the solution tank. Drain, rinse, and refill the solution tank with clear cool water before operating the FaST or ec-H<sub>2</sub>O system. Conventional cleaning detergents may cause a FaST or ec-H<sub>2</sub>O system failure.*

## CONVENTIONAL SCRUBBING MODE

**FOR SAFETY: Before leaving or servicing machine, stop on level surface, set parking brake, turn off machine, and remove key.**

1. Open either the left or right solution tank fill cover.
2. Partially fill solution tank with water (not to exceed 60°C / 140°F). Pour the required amount of detergent into the solution tank. Fill the solution tank with water until the level is just below the indicator tab.

**! WARNING: Flammable materials can cause an explosion or fire. Do not use flammable materials in tank(s).**

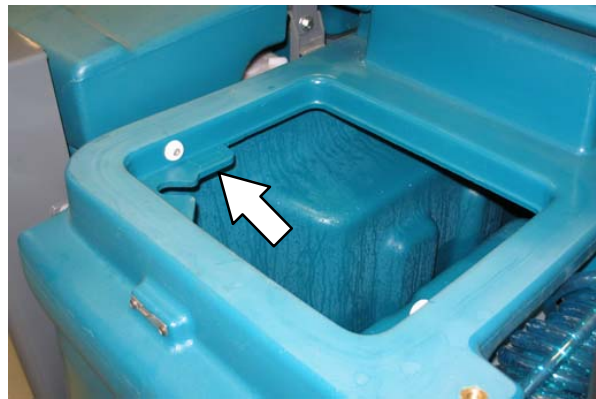

**ATTENTION: For Conventional Scrubbing, only use recommended cleaning detergents. Machine damage due to improper detergent usage will void the manufacturer's warranty.**

*NOTE: Pour a recommended foam control solution into the recovery tank if excessive foam appears. For specific detergent recommendations, contact a TENNANT representative.*



## OPERATION

### ES (EXTENDED SCRUB) MODE WITH AUTO-FILL

**FOR SAFETY:** Before leaving or servicing machine, stop on level surface, set parking brake, and turn off machine.

1. Connect the hose from the water source (not to exceed 60°C / 140°F) to the auto-fill connection.

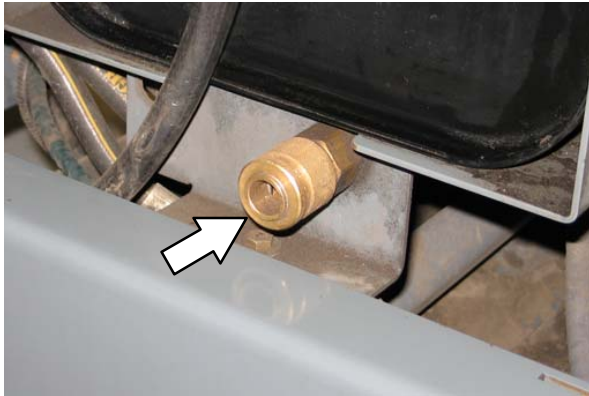

2. Turn the ignition switch to the on position (without starting) and turn on the water source. The auto-fill automatically fills the tanks to the proper level.
3. Fill the detergent tank with the proper detergent.

**ATTENTION:** For ES Scrubbing, only use recommended low-foaming cleaning detergents. Machine damage due to the use of improper detergent will void the manufacturer's warranty.

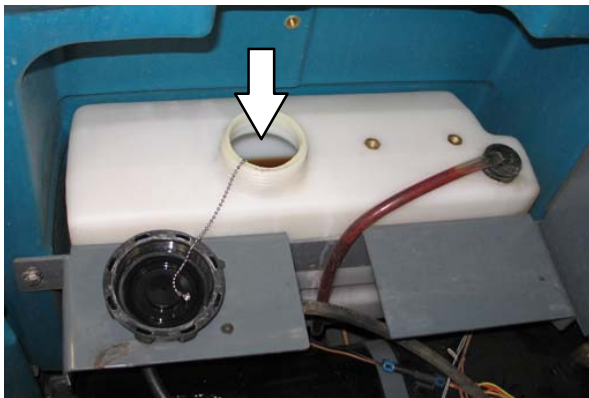

### ES (EXTENDED SCRUB) MODE - MANUALLY FILLING TANKS

**FOR SAFETY:** Before leaving or servicing machine, stop on level surface, set parking brake, and turn off machine.

1. Open either the left or right solution tank cover and fill the solution tank with water (not to exceed 60°C / 140°F) until the level is just below the indicator tab.

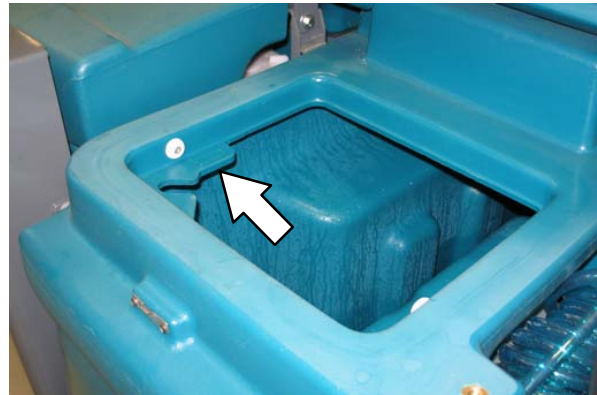

2. Open the recovery tank cover and fill the recovery tank with water (not to exceed 60°C / 140°F) until the recovery tank is approximately half full.

**WARNING:** Flammable materials can cause an explosion or fire. Do not use flammable materials in tank(s).

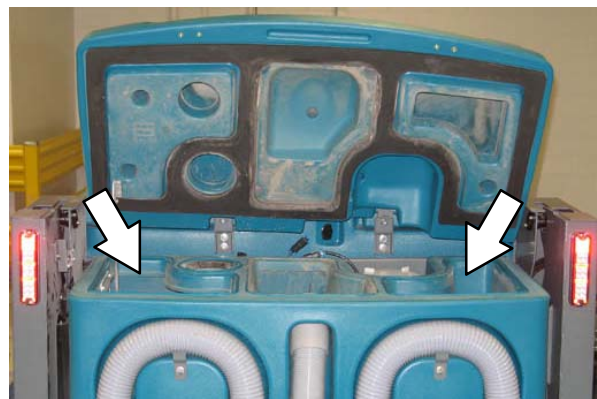



## SETTING SCRUB MODES

Before scrubbing, determine which scrub mode will be used (FaST, ES or conventional). Then set the scrub brush pressure and adjust the solution flow levels.

### SETTING FaST MODE

The *FaST button* enables the FaST system to come on when the *1-STEP Scrub button* is activated. The light next to the button will come on. The machine will default to the last setting used when it is powered on or off.

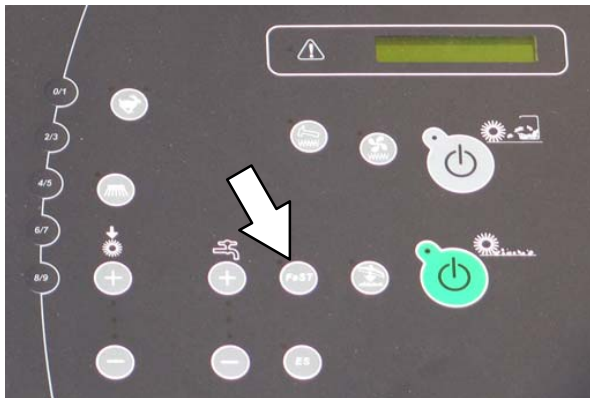

### SETTING ES (EXTENDED SCRUB) MODE

The *ES button* enables the ES system to come on when the *1-STEP Scrub button* is activated. The light next to the button will come on. The machine will default to the last setting used when it is powered on or off.

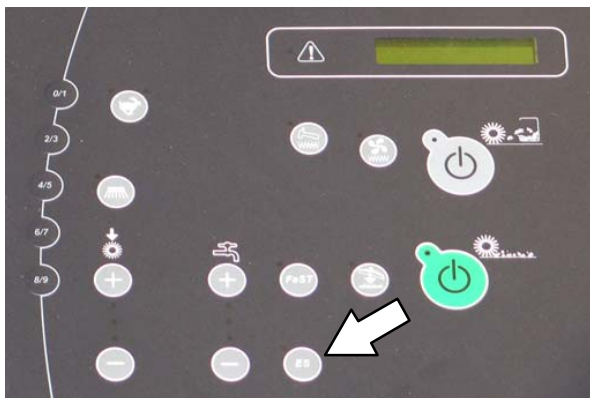

**NOTE:** When the ES system is turned on there is a slight delay before the ES pump begins operating.

### SETTING ec-H2O MODE

The *ec-H2O button* enables the *ec-H2O* system to come on when the *1-STEP Scrub button* is activated. The light next to the button will come on. The machine will default to the last setting used when it is powered on or off.

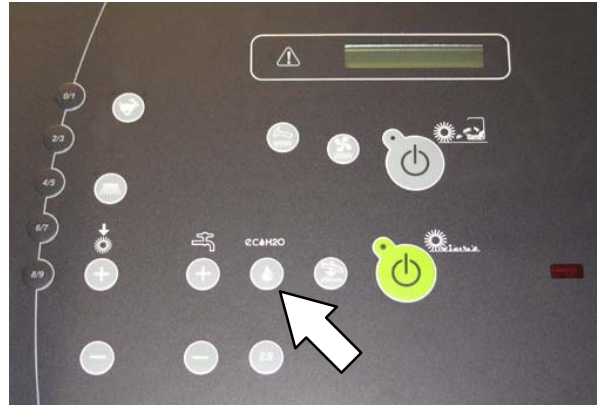

**NOTE:** Storage or transporting machines equipped with *ec-H2O* in freezing temperatures requires special procedures. Follow the freeze protection procedure located in the **STORAGE INFORMATION** section.

# OPERATION

## SETTING BRUSH PRESSURE

Under normal cleaning conditions, the brush pressure should be set to the minimum setting (the bottom light). Under heavy grime conditions, the brush pressure can be set to a higher setting. Travel speed and floor conditions will affect cleaning performance.

With the *1-STEP Scrub button* or the *1-STEP Sweep button* activated, press either the *Brush Pressure increase button (+)* or the *Brush Pressure decrease button (-)* to set the brush pressure for the surface being cleaned. If brushes are worn, it may be necessary to increase the brush pressure. The machine will default to the last setting used when it is powered on or off.

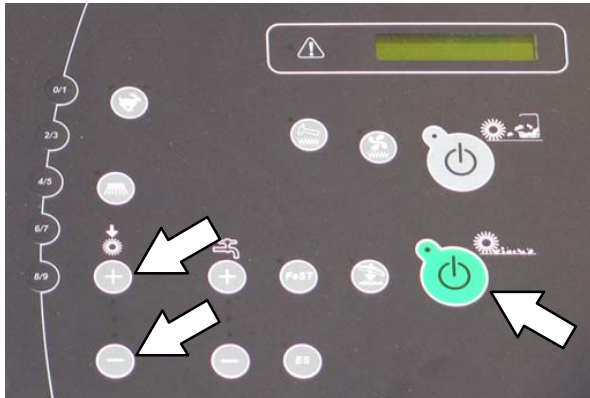

## SETTING SOLUTION FLOW

With the *1-STEP Scrub button* activated, press either *Solution increase button (+)* or *Solution decrease button (-)* to set the solution flow level. Travel speed and floor conditions will affect scrubbing performance. The machine will default to the last setting used when the machine is powered on or off.

**NOTE:** In the *ES* and *FaST* modes, the solution flow buttons control both the solution AND detergent flow levels.

To turn off all solution and detergent flow, press the *Solution decrease button (-)* until all indicator lights are off.

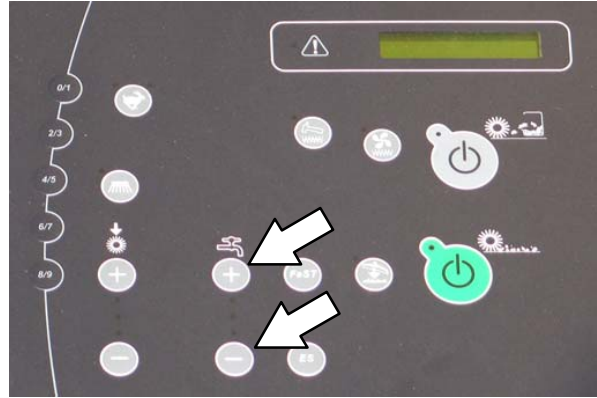

## CONVENTIONAL, FaST, AND ec-H2O SOLUTION FLOW

Under normal soilage conditions the solution flow level should be set to the lowest setting (the bottom light). Under heavy grime conditions, the solution flow level should be set to the higher settings (middle or top lights).

## ES (EXTENDED SCRUB) SOLUTION FLOW

**For ES machines, the detergent flow is turned off when the solution flow is in the lowest setting (one light).** Under normal soilage conditions, the solution flow level should be alternated between the middle and lowest setting. The middle setting (two lights) allows solution AND detergent flow. The lowest setting (one light) allows solution flow WITHOUT adding detergent. Detergent does not have to be continuously added with the solution flow to attain effective scrubbing results.

**SCRUBBING**

The *1-STEP Scrub button* operates all the scrubbing functions. (The machine also wet sweeps while scrubbing).

**FOR SAFETY: Do not operate machine, unless operator manual is read and understood.**

1. Start the machine.

*NOTE: Make sure the scrub modes / settings are set before scrubbing.*

2. Press the *1-STEP Scrub button*. The light on the button will come on. All the preset scrubbing functions will turn on.

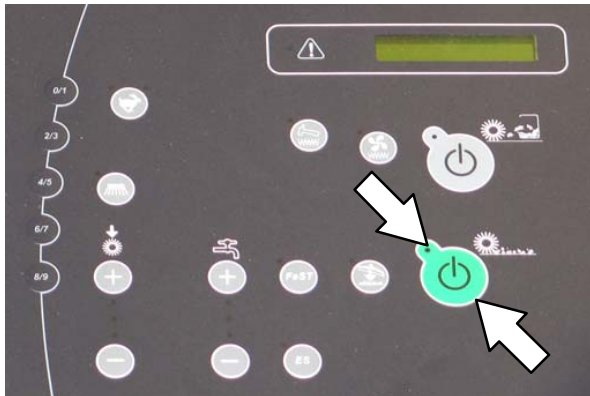

*NOTE: DO NOT turn on the FaST or ec-H2O system during conventional scrubbing. Conventional cleaning detergents could cause a FaST or ec-H2O system failure. Drain, rinse, and refill the solution tank with cool clean water before operating the FaST or ec-H2O system.*

3. Release the parking brake, then press the *Directional pedal* to begin scrubbing.

**WARNING: Flammable materials or reactive metals can cause an explosion or fire. Do not pick up.**

**FOR SAFETY: When using machine, go slow on inclines and slippery surfaces.**

*NOTE: The squeegee automatically rises when the machine is driven backwards. This prevents damaging the squeegee.*

*NOTE: The ec-H2O system indicator light will not turn on until the machine starts scrubbing.*

**ec-H2O Model:** If an alarm sounds and the ec-H2O system indicator light begins to blink red, the ec-H2O module must be flushed to resume ec-H2O operation (See ec-H2O MODULE FLUSH PROCEDURE).



*NOTE: When the alarm sounds and the light blinks red, the machine will bypass the ec-H2O system. To continue scrubbing, press the ec-H2O button to turn off the ec-H2O system.*

**ATTENTION: (ec-H2O model) Do not allow solution tank to run dry. ec-H2O module failure may result if operated without water for an extended period.**

<b>ec-H2O SYSTEM INDICATOR LIGHT CODE</b>	<b>CONDITION</b>
Solid green	Normal operation
Blinking red	Flush ec-H2O module
Solid red	Contact Service Center

4. Release the *directional pedal* and press the *brake pedal* to stop the machine.
5. Press the *1-STEP Scrub button* to stop scrubbing. The light next to the button will go off and scrubbing functions will stop after a short delay.

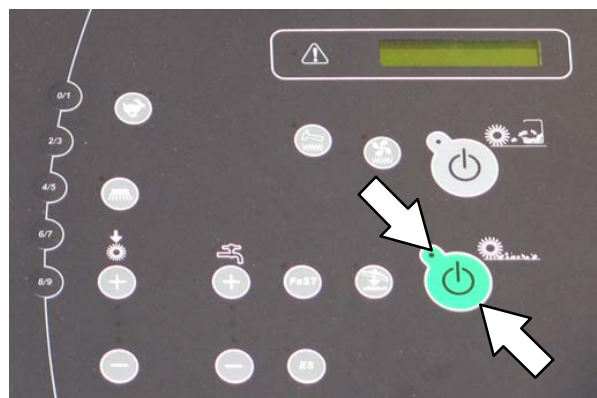

# OPERATION

## DOUBLE SCRUBBING

For heavily soiled areas, use the double scrubbing method.

Double scrubbing can be performed using the FaST SCRUBBING SYSTEM (option), ec-H<sub>2</sub>O SCRUBBING SYSTEM (option) or CONVENTIONAL SCRUBBING methods.

Side brush option (S/N 000000–001278): Before double scrubbing, manually lock the side brush squeegee into the raised position. Pull the pin from the side brush squeegee bracket, manually raise the side squeegee to the upper position, then reinsert the brush pin.



Side brush option (S/N 001279– ): Before double scrubbing, remove the side brush bumper. Pull the pins and remove the squeegee bumper.

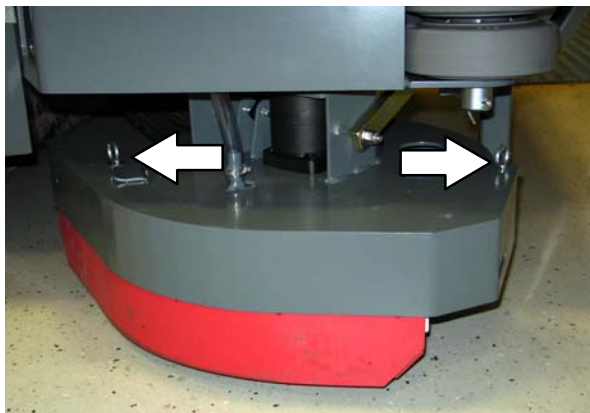

Press the 1-STEP Scrub button, and then the Scrub vacuum fan/squeegee button. The light above the Scrub vacuum fan/squeegee button will turn off, the squeegee will rise, and the vacuum fan will stop operating. Scrub the heavily soiled area.

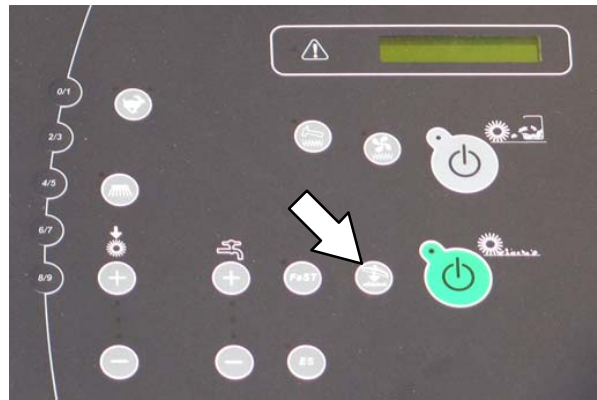

**FOR SAFETY: When using machine, go slow on inclines and slippery surfaces.**

Let the cleaning solution soak on the floor for 5–15 minutes. Then place the side squeegee into the lower position and lock into place with the pin.

Press the *Scrub vacuum fan/squeegee button* again to lower the squeegee and turn on the vacuum fan. The light above the button will come on. Scrub the floor a second time to pick up the cleaning solution.



**WARNING: Flammable materials or reactive metals can cause an explosion or fire. Do not pick up.**

*NOTE: To turn off the solution flow when scrubbing the area a second time, repeatedly press the Solution decrease button (-) until all lights above the button are off.*

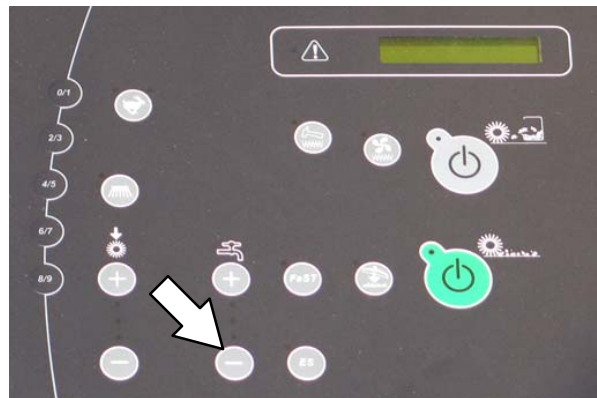

*NOTE: Double scrubbing is not recommended in areas where the cleaning solution will run under racks or damage products.*



**WATER PICKUP MODE (NO SCRUBBING)**

The machine can be used to pick up water or non-flammable liquid spills without scrubbing.

To pick up water or non-flammable liquid spills, make sure the 1-STEP Scrub button is not activated. The light next to the button must be off.

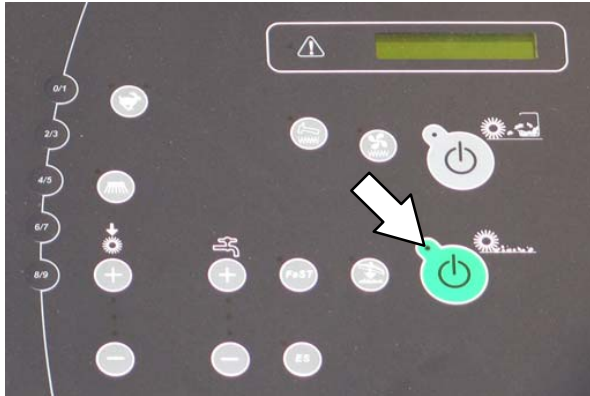

**WARNING:** Flammable materials or reactive metals can cause an explosion or fire. Do not pick up.

Press the *Scrub vacuum fan/squeegee button*. The light above the button will come on, the squeegee will lower, and the vacuum fan will start operating. Pick up the water or non-flammable liquid spill.

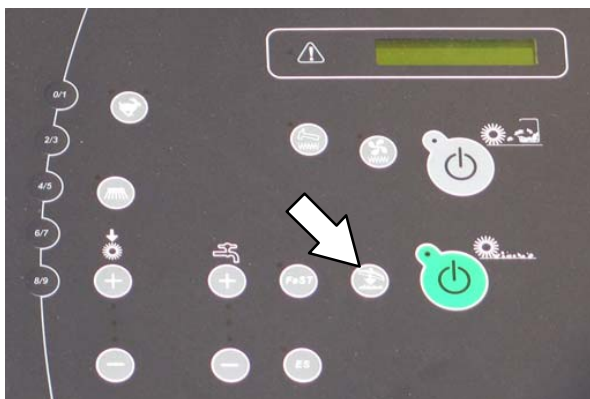

**SWEEPING**

*NOTE: The 1-STEP Sweep button operates all the sweeping functions (without scrubbing).*

**FOR SAFETY: Do not operate machine, unless operator manual is read and understood.**

Side brush option (S/N 000000-001278): Before sweeping, manually lock the side brush squeegee into the raised position. Pull the pin from the side brush squeegee bracket, manually raise the side squeegee to the upper position, then reinsert the brush pin.



Side brush option (S/N 001279- ): Before sweeping, remove the side brush bumper. Pull the pins and remove the squeegee bumper.

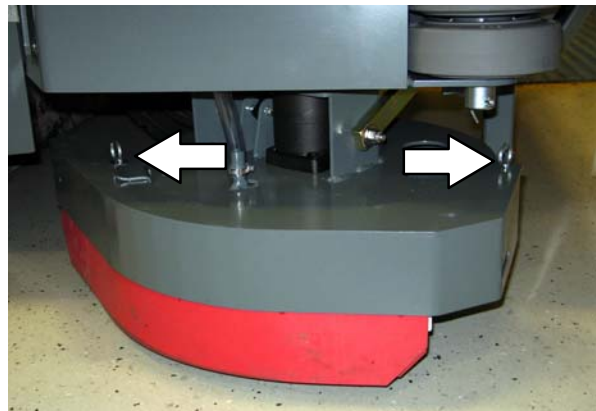

## OPERATION

1. Start the machine.

*NOTE: Make sure the sweep modes / settings are set before sweeping.*

2. Press the *1-STEP Sweep button*. The light on the button will come on. All the preset sweeping functions will turn on.

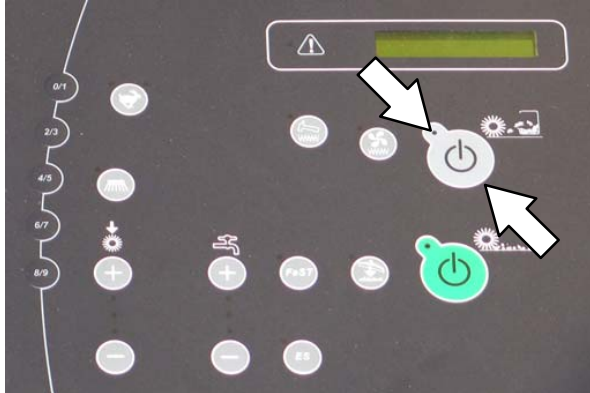

3. Release the parking brake, then press the *Directional pedal* to begin sweeping.

**FOR SAFETY: When using machine, go slow on inclines and slippery surfaces.**

*NOTE: Press the Sweep vacuum fan button to turn off the vacuum fan when sweeping over large wet areas or standing water. This prevents the hopper dust filter from getting wet while sweeping.*

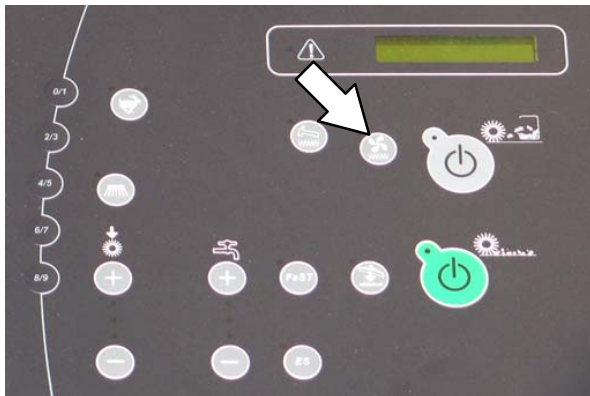

4. Release the *Directional pedal* and press the *Brake pedal* to stop the machine.

5. Press the *1-STEP Sweep button* to stop sweeping. The light next to the button will turn off and the sweeping functions will stop after a short delay.

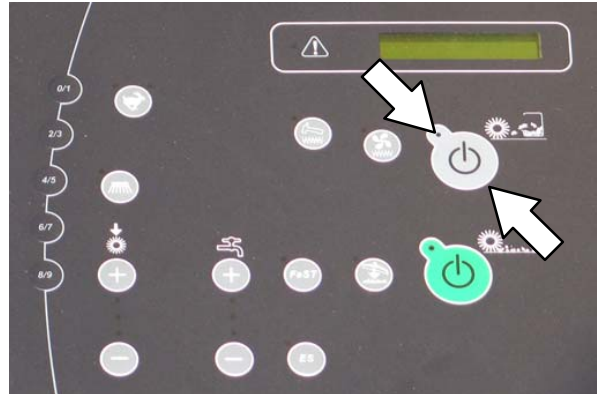

*NOTE: The filter shaker automatically shakes the filter for a short time each time the 1-STEP Sweep button is turned off.*

6. Empty the debris hopper at the end of each shift or as needed. See *EMPTYING THE HOPPER* section of this manual

**EMPTYING THE HOPPER**

1. Drive the machine to a debris site or container.
2. Press the *Filter shaker button*. The shaker operates for approximately 30 seconds. The indicator light comes on while the filter shaker is operating.

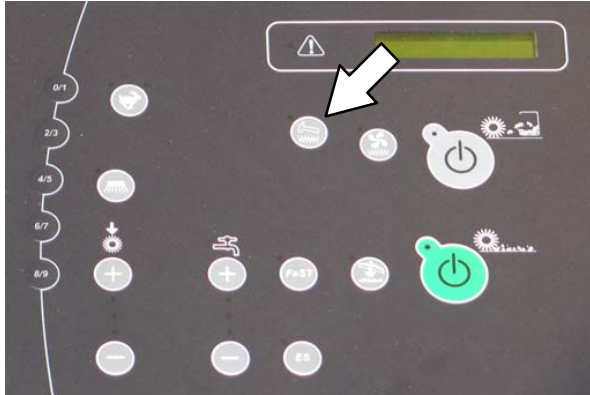

3. After the filter shaker stops, press and hold the top of the *Hopper raise/lower button* to raise the hopper. Release the button when the hopper is at the desired position.

**FOR SAFETY: When using machine, make sure adequate clearance is available before raising hopper. Do not raise hopper when machine is on an incline.**

*NOTE: Be aware the minimum ceiling height needed to raise the hopper is 2500 mm (98 in).*

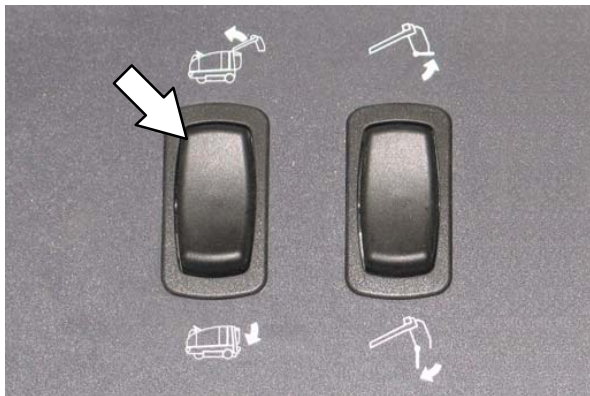

4. Slowly back the machine up to the debris container.

**FOR SAFETY: When using machine, use care when reversing machine. Move machine with care when hopper is raised.**

5. Press and hold the bottom of the *Hopper door open/close button* to open the hopper door and empty the contents from the hopper.

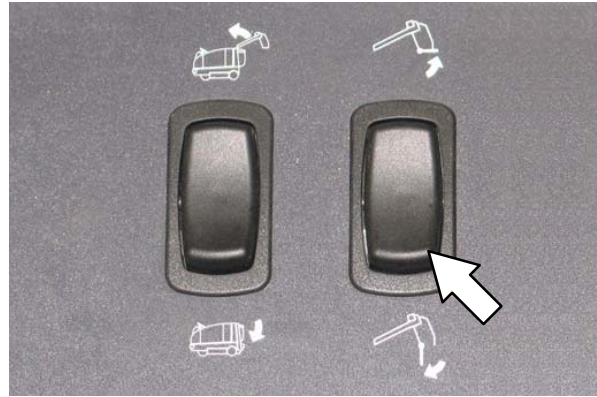

6. Slowly drive the machine forward away from the debris site or container.
7. Stop the machine, then press and hold the bottom of the *Hopper raise/lower button* until the hopper is completely lowered.

*NOTE: The hopper door will close automatically when the hopper is lowered. The hopper door can be closed by pressing the top of the hopper door open/close button.*





# OPERATION

## ENGAGING HOPPER SUPPORT PIN

The hopper support pin is a safety feature used to prevent the raised hopper from falling. Always use the hopper support pin whenever leaving the hopper in a raised position.

1. Stop the machine.
2. Press and hold the top of the *Hopper raise/lower switch* to raise the hopper. Release the switch when the hopper is at the desired position.

 **WARNING: Lift arm pinch point. Stay clear of hopper lift arms.**

**FOR SAFETY: When using machine, make sure adequate clearance is available before raising hopper.**

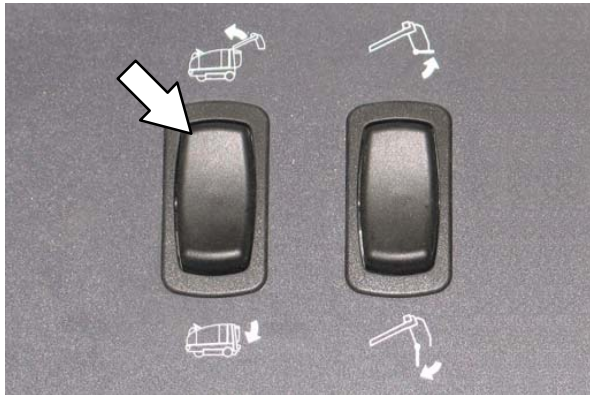

3. Set the parking brake.
4. Remove the hopper support pin from the storage tube.

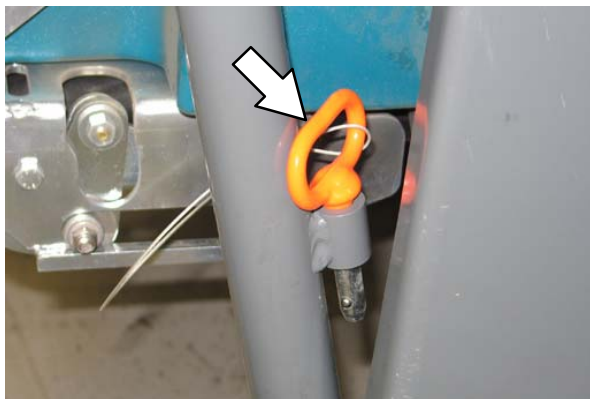

5. Insert the hopper support pin into one of the three hopper support holes. Lower the hopper until it rests on the support pin.

 **WARNING: Raised hopper may fall. Engage hopper support pin.**

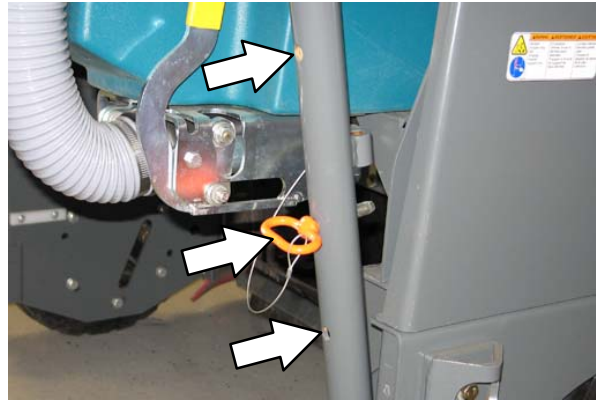

## DISENGAGING HOPPER SUPPORT PIN

1. Set the parking brake.
2. Press and hold the top of the *Hopper raise/lower switch* until the hopper is off the support pin.
3. Remove the hopper support pin from the hopper support hole and insert it into the storage tube.
4. Sit in the operators seat, then press and hold the bottom of the *Hopper raise/lower switch* until the hopper is completely lowered.

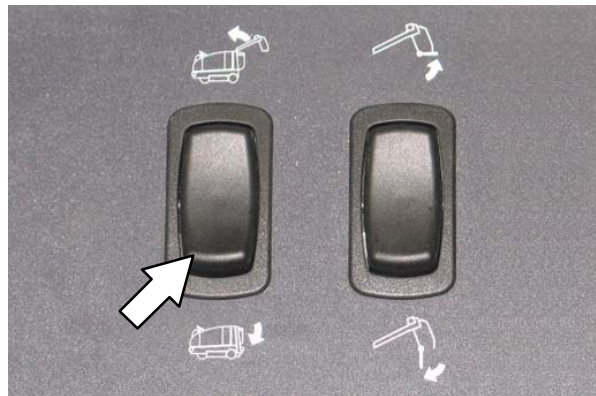

 **WARNING: Lift arm pinch point. Stay clear of hopper lift arms.**



**REMOVING THE HOPPER DUST FILTER**

*NOTE: Empty hopper before removing the hopper dust filter.*

1. Raise the hopper to the middle support position and engage the hopper support pin. See *ENGAGING HOPPER SUPPORT PIN* section of this manual.

*NOTE: Do NOT raise the hopper to the top support position when accessing the dust filter.*

**WARNING:** Raised hopper may fall. Engage hopper support pin.

**WARNING:** Lift arm pinch point. Stay clear of hopper lift arms.

2. Turn off the machine.

**FOR SAFETY: Before leaving or servicing machine, stop on level surface, set parking brake, turn off machine, and remove key.**

3. Loosen the hose clamp on the squeegee vacuum hose.
4. Disconnect the squeegee vacuum hose from the hopper.



5. Unhook the handles from the filter cover.

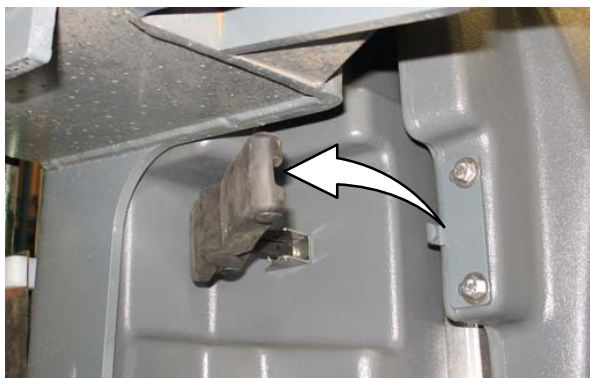

6. Open the filter cover and rest it against the machine.



7. Remove the dust filter and perma-filter tray from the hopper.



8. Clean or discard the dust filter. See the *CLEANING THE HOPPER DUST FILTER* section of this manual.

9. Place the perma-filter tray into the hopper.

10. Place the cleaned or new dust filter into the hopper. Position the filter screen side up as shown below.

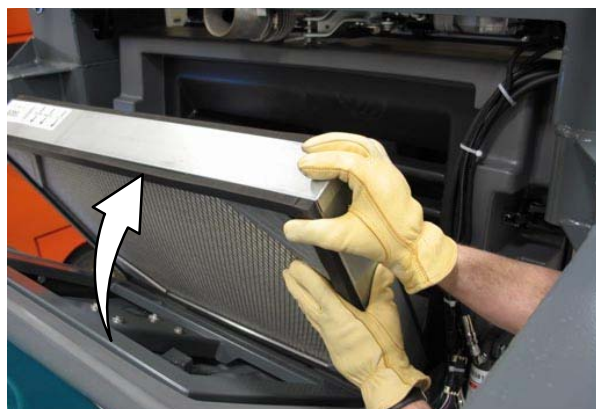

## OPERATION

11. Close the filter cover and secure the filter cover to the hopper with the handles.
12. Reconnect the squeegee vacuum hose to the hopper.
13. Disengage the hopper support pin and lower the hopper. See the *DISENGAGING HOPPER SUPPORT PIN* section of this manual.

## CLEANING THE HOPPER AND DEBRIS SCREEN

**FOR SAFETY: Before leaving or servicing machine, stop on level surface, and set parking brake.**

1. Disconnect the vacuum hose from the debris screen.

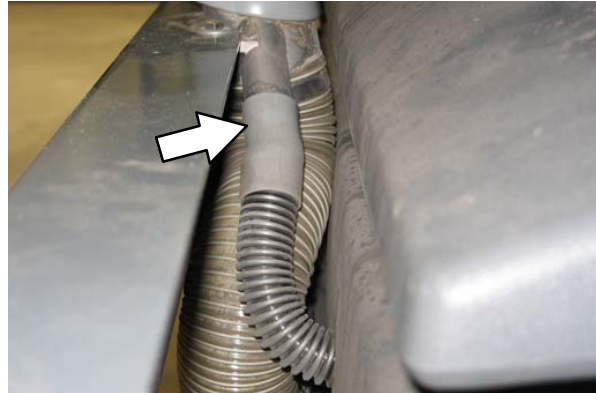

2. Raise the hopper to the middle support position and engage the hopper support pin. See *ENGAGING HOPPER SUPPORT PIN* section of this manual.

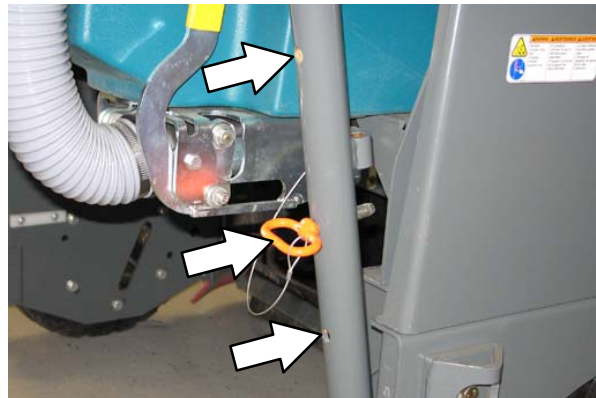

**WARNING:** Raised hopper may fall. Engage hopper support pin.

**WARNING:** Lift arm pinch point. Stay clear of hopper lift arms.

3. Turn off the machine.

4. Remove the filter from the hopper. See the **REMOVING THE HOPPER DUST FILTER** section of this manual.

**NOTE:** Do **NOT** raise the hopper to the top support position when accessing the dust filter.

5. Start the machine.
6. Press and hold the bottom of the *hopper door open / close switch* until the hopper door is completely open.



7. Turn off the machine.
8. Flush dirt and debris from the debris hose and debris screen and out into the hopper.

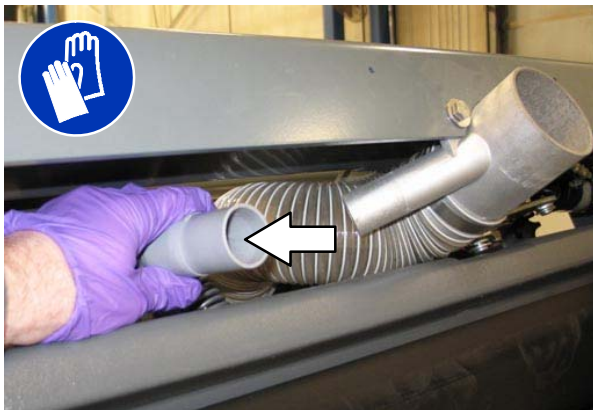

9. Rinse dirt and debris from the debris screen and the hopper. If necessary, remove the debris screen to clean.



10. Reinstall the hopper dust filter. See **REMOVING THE HOPPER DUST FILTER** section of this manual.
11. Disengage the hopper support pin and lower the hopper. See the **DISENGAGING HOPPER SUPPORT PIN** section of this manual.



## OPERATION

### DRAINING AND CLEANING THE RECOVERY TANK

Drain and clean the recovery tank daily or when the recovery tank full indicator comes on.

Clean the outside of the recovery tank with vinyl cleaner.

**FOR SAFETY: Before leaving or servicing machine, stop on level surface, set parking brake, turn off machine, and remove key.**

### DRAINING THE RECOVERY TANK WITH THE DRAIN HOSE

1. Lift the recovery tank cover.



2. Place the recovery tank drain hose nozzle next to a floor drain.

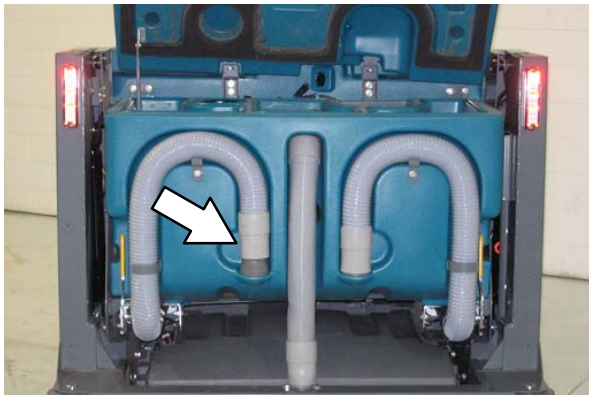

3. Open the recovery tank Variable Drain Valve.

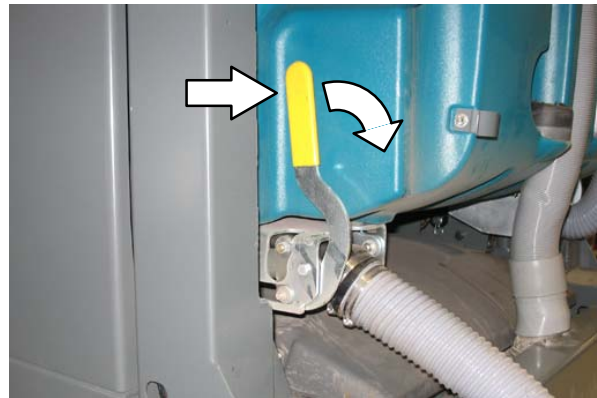

4. Rinse dirt and debris down through the drain hole in the demister tray and flush the vacuum hose.

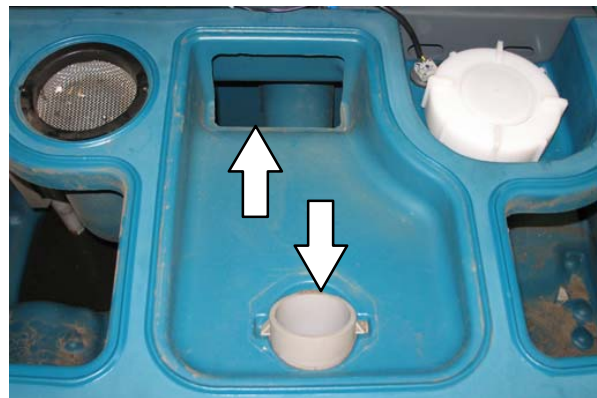

**NOTE: DO NOT use steam to clean tanks. Excessive heat can damage tanks and components.**

5. Remove the vacuum screen from the recovery tank and rinse the screen.



6. Rinse the float sensor.



7. ES machines: Rinse the ES filter. If necessary, remove the ES filter from the recovery tank.

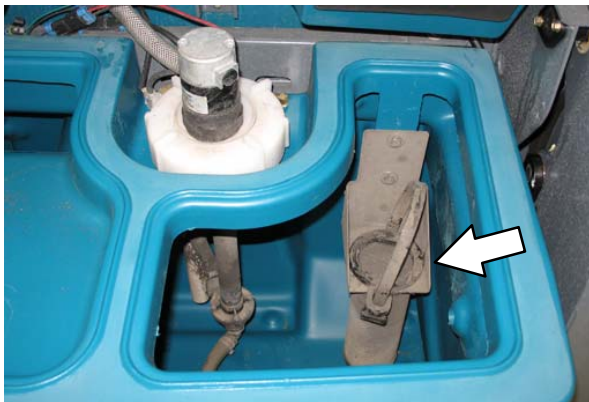

8. Rinse dirt and debris towards the recovery tank drain. Allow the recovery tank to drain.

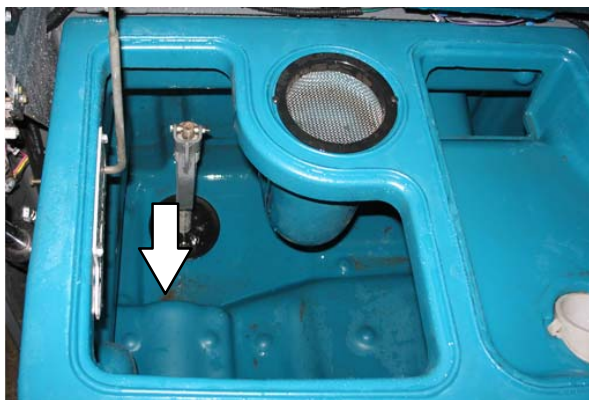

9. Close the recovery tank Variable Drain Valve.

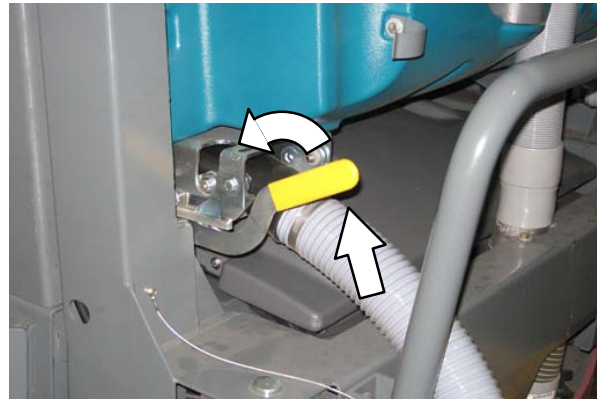

10. Reinstall the recovery tank drain hose onto the back of the recovery tank and close the recovery tank cover.

### DRAINING THE RECOVERY TANK WITH THE DRAIN PLUG

Use the drain plug to drain the recovery tank if the tank is draining slowly or if the drain hose is plugged.

1. Park the machine so the larger drain in the recovery tank is positioned over the disposal drain. Set the parking brake.
2. To avoid getting the hopper filter wet, raise the hopper and engage the hopper support pin in the lowest position.

**WARNING:** Raised hopper may fall. Engage hopper support pin.

**WARNING:** Lift arm pinch point. Stay clear of hopper lift arms.



**FOR SAFETY:** Before leaving or servicing machine, stop on level surface, set parking brake, turn off machine, and remove key.



## OPERATION

3. Lift the drain plug handle and remove the drain plug from the tank.

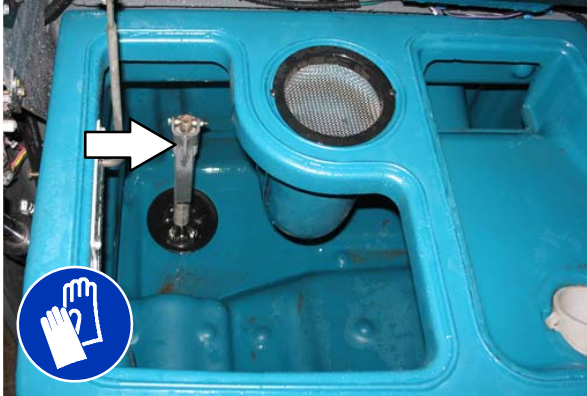

6. Rinse dirt and debris out the open drain.



4. Open the recovery tank Variable Drain Valve.

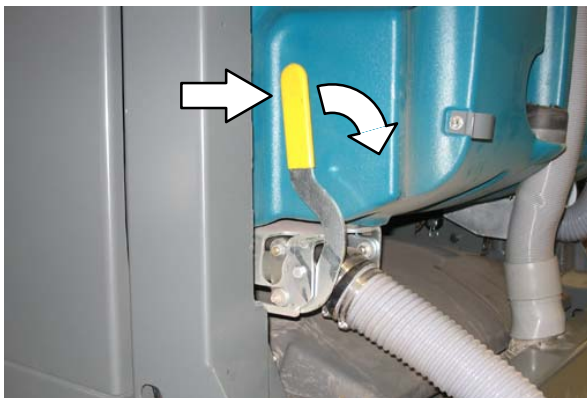

7. Clean the drain hole, then reinsert the drain plug. Push the handle down to tighten. Be sure the drain plug is fully seated before tightening.

*NOTE: If necessary, turn the handle clockwise for a tighter fit and counterclockwise for a looser fit.*

5. Remove the recovery tank drain hose from the back of the recovery tank, then rinse the dirt and debris from the hose into the tank.



8. Close the recovery tank Variable Drain Valve.

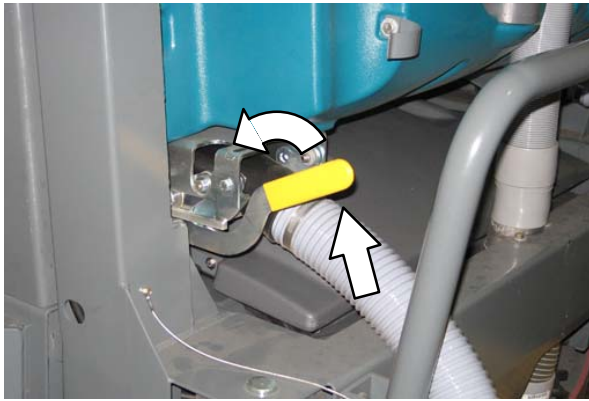

9. Reinstall the recovery tank drain hose onto the back of the recovery tank.
10. Remove the hopper support pin and insert it into the storage tube. Then lower the hopper.
11. Close the recovery tank cover.

### DRAINING AND CLEANING THE SOLUTION TANK

The solution tank on non-ES machines does not require regular maintenance. If deposits form on the bottom of the tank, rinse the tank with a strong blast of warm water.

Clean the outside of the solution tank with vinyl cleaner.

The solution tank on machines with the ES option should be drained and cleaned daily.

**FOR SAFETY: Before leaving or servicing machine, stop on level surface, set parking brake, turn off machine, and remove key.**

1. Open the solution tank cover(s).



2. Place the solution tank drain hose nozzle next to a floor drain.

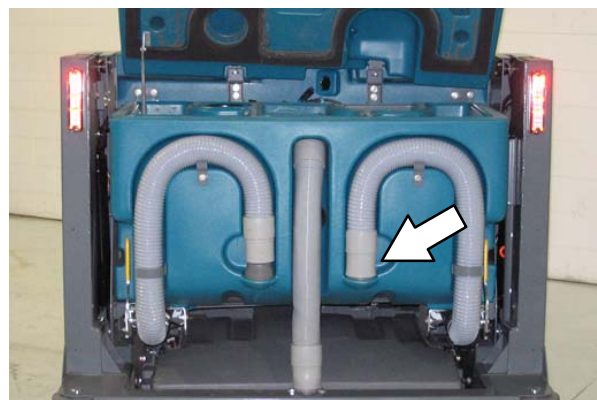

## OPERATION

3. Open the solution tank Variable Drain Valve.

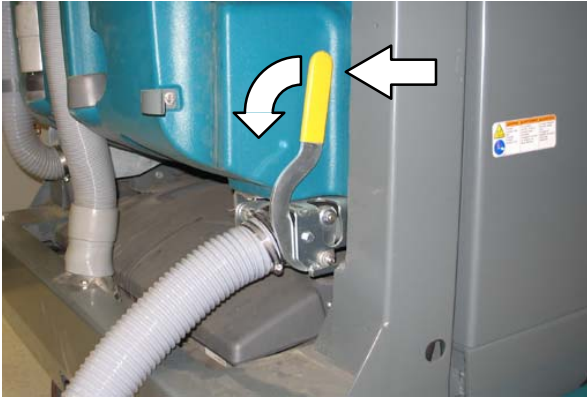

6. Close the solution tank Variable Drain Valve.

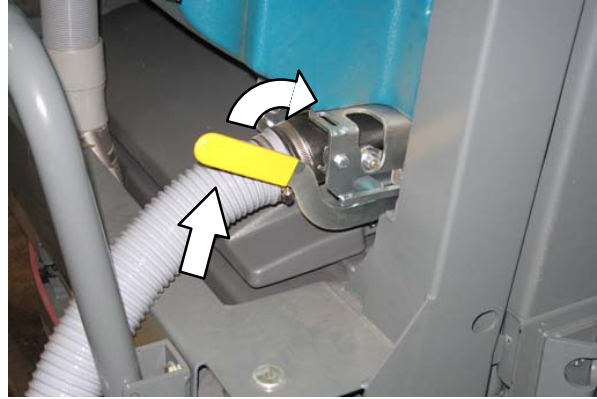

4. Rinse the solution tank. Flush dirt and debris toward the solution tank drain.

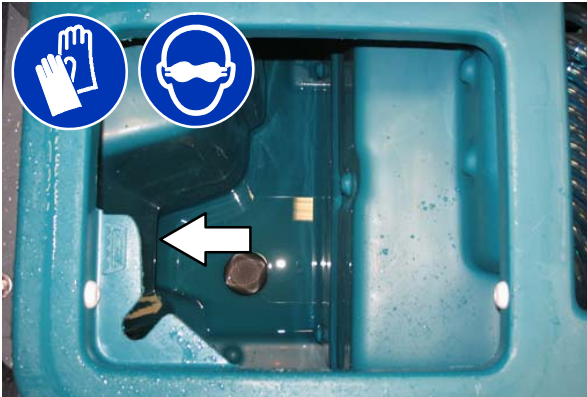

7. Reinstall the solution tank drain hose onto the back of the recovery tank.

8. Close the solution tank cover(s).

5. Rinse the float sensor and the screen filter. Allow the solution tank to drain.

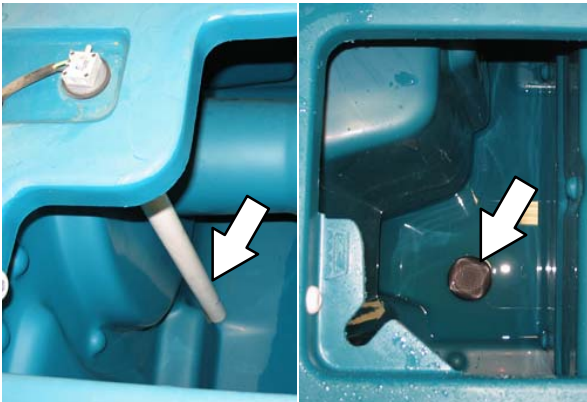



**FAULT INDICATOR(S)**

This machine is equipped with two visual indicators, a red indicator light and an LCD (liquid crystal display).

The red indicator light will blink continuously indicating that a fault has occurred.



The LCD will display a fault code. If there is more than one fault, each fault will alternately display.



All faults are also accompanied by an audible alarm to alert the operator a fault has occurred.

To reset the fault indicators, turn the machine off, then eliminate the cause of the fault. The fault indicator will reset when the machine is restarted.

Refer to the table below to determine the cause and remedy for the fault.

Fault Code (Displayed in LCD)	Cause(s)	Result	Remedy
F1: Hopper Up	Hopper is up	Terminates sweeping and scrubbing functions	Lower hopper completely.
F3: Clogged Hyd	Hydraulic filter is clogged	-	Replace hydraulic filter.
F4: Shaker Filter	Hopper dust filter is clogged	-	Activate filter shaker to unclog hopper dust filter.
F5: Hopper Fire	Fire in the hopper	Terminates sweeping functions and closes hopper door	Shut off machine. Extinguish fire. If necessary, call emergency personnel.
F6: Sol. Tank E.	Solution tank is empty	-	Fill solution tank.
F7: Rec. Tank Full	Recovery tank is full	Terminates scrubbing functions	Press the <i>Scrub vacuum fan/squeegee button</i> for one minute of extended water pickup. Empty recovery tank. ES models: activate the ES system to prevent this.
F8: High Eng Temp *GM engine (S/N 000000-003999)	Engine temperature is high	-	Shut off machine. Contact TENNANT service representative.
F9: High Hyd Temp	Hydraulic fluid temperature is high	-	Shut off machine. Contact TENNANT service representative.
F10: Low Fuel	Low fuel	-	Fill fuel tank (gasoline). Replace fuel tank (LPG)
F11: Open Scb Vac (Optional)	Scrub vacuum hose is not connected	-	Connect vacuum hose to squeegee assembly.
F12: Seat Sw Open (Optional)	Operator not in the seat while engine is running and parking brake not engaged	Engine will shut off	Engage parking brake before leaving the machine.

*\*NOTE: Mitsubishi engines machine serial number 004000 and above will display a "check engine" indicator and will automatically shut the machine off if the coolant is too hot.*

# OPERATION

## CONDITIONS / WARNINGS

Condition codes are typically caused by the operator attempting to activate modes that are unavailable. The code will appear in the LCD.

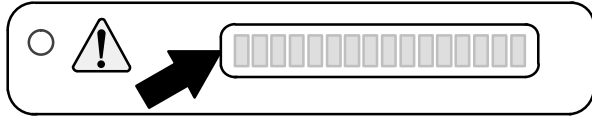

Refer to the table below to determine the cause of the condition.

Condition Code (Displayed in LCD)	Condition(s)	Description
C2: No Sweep Vac	Sweep vacuum unavailable	Sweep vacuum not available when 1-STEP scrub system is active.
C3: No FaST Mode	FaST mode unavailable	Only machines equipped with FaST system can be operated in FaST mode.
C4: No ES Mode	ES mode unavailable	Only machines equipped with ES system can be operated in ES mode.
C5: No ES/FaST	ES and FaST systems unavailable	Only machines equipped with ES or FaST system can be operated in these modes.
C6: No Side Sweep	Side sweep unavailable	Side sweep not allowed to operate by itself.

**OPTIONS**

**SPRAY NOZZLE (OPTION)**

The spray nozzle is used to clean the machine and surrounding areas. The solution tank provides a water/solution supply for the spray nozzle. A wand is included with the spray nozzle.

*NOTE: Do NOT get water on electronic components when using the spray nozzle to clean the machine.*

**FOR SAFETY: Before leaving or servicing machine, stop on level surface, set parking brake, and turn off machine.**

1. Turn the key to the on position (without starting the machine).

*NOTE: The spray nozzle can be operated while the engine is running, but it is recommended to turn the engine off while using the spray nozzle.*

2. Press the top of the *Spray nozzle switch* to turn on the water supply. The light on the switch will come on when the spray nozzle is activated.

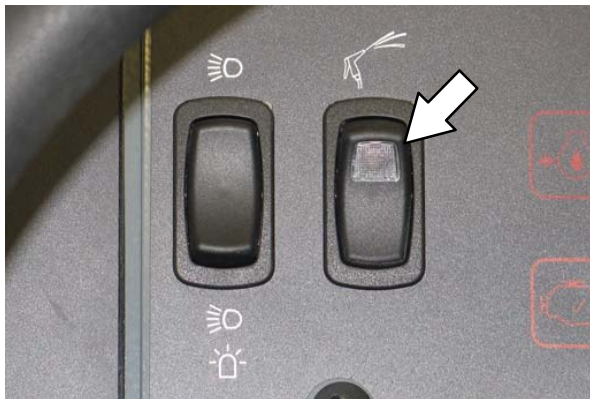

3. Remove the spray nozzle from the storage area and clean as required.

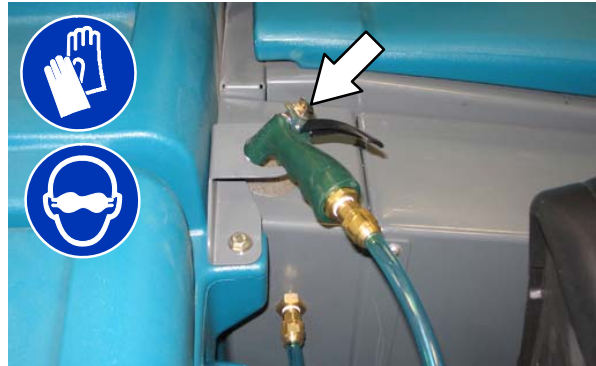

**FOR SAFETY: When using pressurized air or water, wear eye protection.**

4. If cleaning a hard to reach area, install the wand onto the spray nozzle.

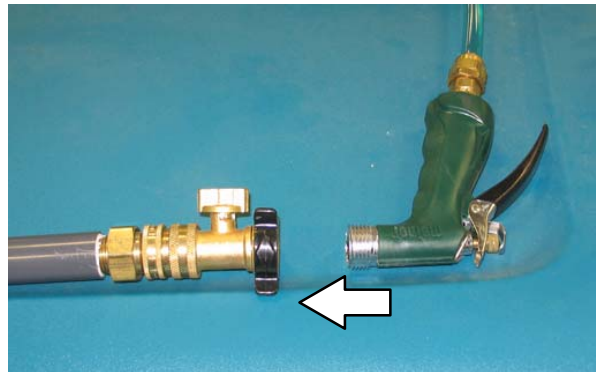

5. Twist the off/on knob to turn on the wand.

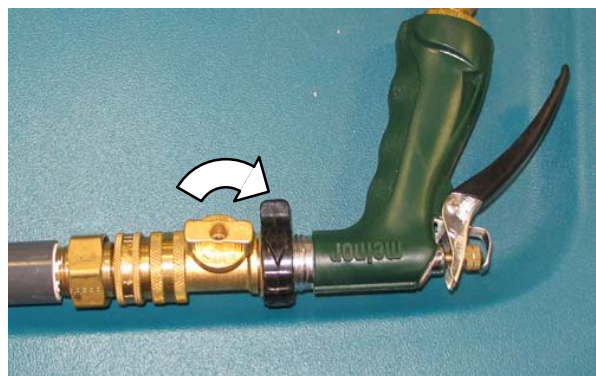

6. When finished cleaning, place the spray nozzle and wand back into their storage locations.

7. Press the bottom of the *Spray nozzle switch* to turn off the water supply.

## OPERATION

### VACUUM WAND (OPTION)

**FOR SAFETY: Before leaving or servicing machine, stop on level surface, set parking brake, turn off machine, and remove key.**

1. Remove the vacuum wand nozzle and hose from the storage bag.



2. Attach the wand hose to the vacuum hose.



3. Assemble the wand and nozzle.
4. Start the machine.

**! WARNING: Engine emits toxic gases. Severe respiratory damage or asphyxiation can result. Provide adequate ventilation. Consult with your regulatory authorities for exposure limits. Keep engine properly tuned.**

5. Verify that the *1-STEP Scrub button* is off. The light next to the button will be off.

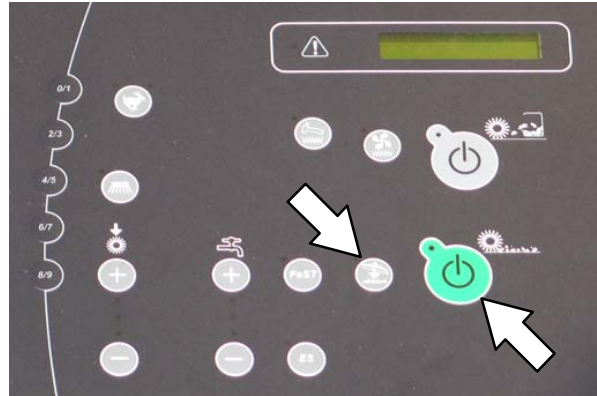

6. Press the *Scrub vacuum fan/squeegee button*. The light above the button will turn on and the vacuum fan will start operating.

**NOTE: The squeegee will lower.**

7. Clean the spill or debris.



8. When finished vacuuming, press the *Scrub vacuum fan/squeegee button* to turn off the vacuum. The light above the button will turn off.
9. Turn off the machine.
10. Disassemble the vacuum wand assembly and return it to the storage bag.
11. Reattach the vacuum hose to the hopper lift arm.



**HIGH PRESSURE WASHER (OPTION)**

The high pressure washer is used to clean the machine and surrounding areas.

*NOTE: Do NOT get water on electronic components when using the high pressure washer to clean the machine.*

**FOR SAFETY: Before leaving or servicing machine, stop on level surface, set parking brake, and turn off machine.**

**FOR SAFETY: When using pressurized air or water, wear eye and ear protection.**

1. Turn off the machine and set the parking brake.

*NOTE: The high pressure washer will not operate unless the parking brake is set.*

2. Open the front shroud.

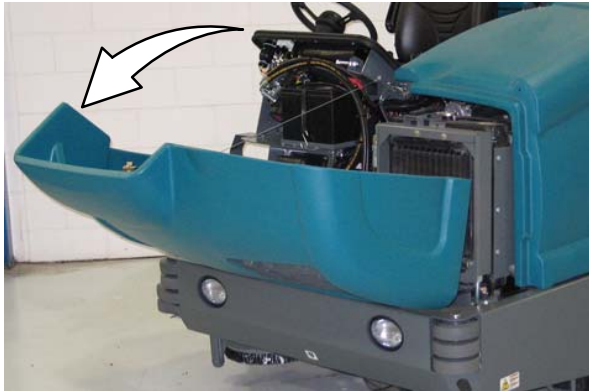

3. Connect the hose to the high pressure washer system.

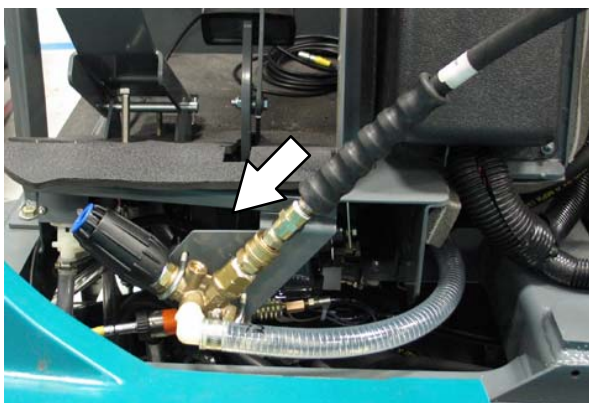

4. Connect the other end of the hose to the wand.

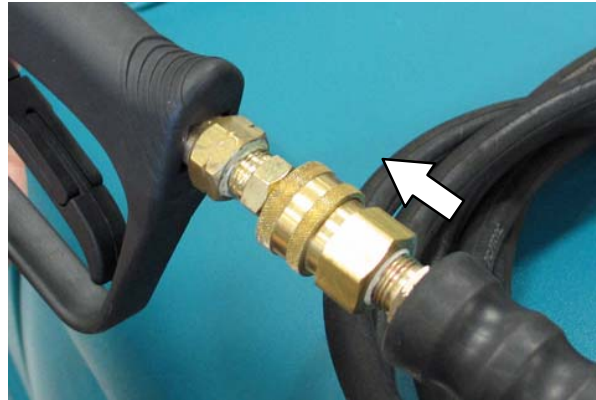

5. Adjust the nozzle on the wand to the desired setting.

Pull the nozzle out for the **Low** pressure setting, or push the nozzle in for the **High** pressure setting. Twist the nozzle for either the **Stream** or **Fan** setting.



6. Start the machine.

**WARNING:** Engine emits toxic gases. Severe respiratory damage or asphyxiation can result. Provide adequate ventilation. Consult with your regulatory authorities for exposure limits. Keep engine properly tuned.

## OPERATION

- Verify that the *1-STEP Scrub* button is off. The light next to the button will be off.



- Press the top of the *Pressure washer switch*.

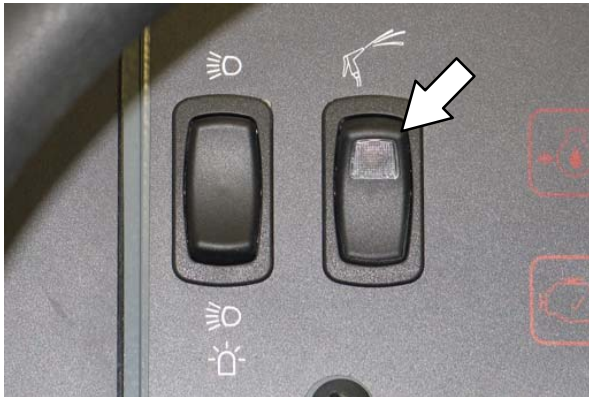

- If necessary, adjust the pressure. Turn the knob clockwise to increase pressure and counterclockwise to decrease pressure.

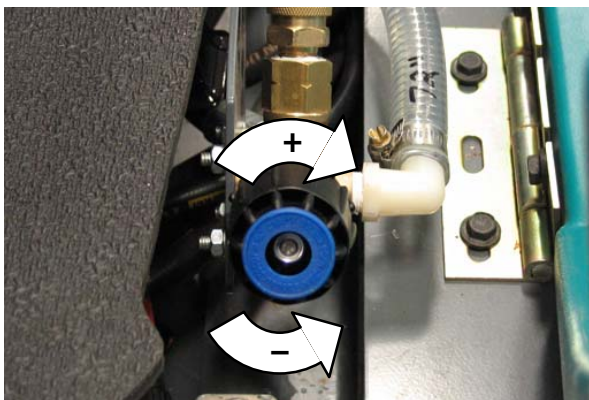

**NOTE:** Adjust the pressure at the wand before adjusting it at the system.

- Squeeze the trigger to begin cleaning.

**WARNING:** Do not spray people or animals. Severe personal injury can result. Wear eye protection. Hold sprayer with two hands.



- When finished cleaning, release the trigger.

- Press the bottom of the *Pressure washer switch* to turn off the washer.

- Turn off the machine.

- Disassemble the hose and wand and return them to the proper storage locations.

- Close the front shroud.

**MACHINE TROUBLESHOOTING**

Problem	Cause	Remedy
Trailing water—poor or no water pickup	Scrub vacuum fan turned off	Turn on vacuum fan
	Worn squeegee blades	Rotate or replace squeegee blades
	Squeegee out of adjustment	Adjust squeegee
	No detergent in solution tank causing squeegee to chatter	Add detergent to solution tank
	Vacuum hose clogged	Flush vacuum hoses
	Vacuum screen dirty	Clean vacuum screen
	Recovery tank cover seals worn	Replace seals
	Debris caught in squeegee	Remove debris
	Vacuum hose to squeegee or recovery tank disconnected or damaged	Reconnect or replace vacuum hose
	Recovery tank cover not completely closed	Check for obstructions and make sure cover is closed properly
Scrub vacuum fan will not turn on	Vacuum fan / squeegee button turned off	Turn on Vacuum fan / squeegee button
	Recovery tank full	Drain recovery tank
	Foam filling recovery tank	Empty recovery tank
		Use less detergent/or use defoamer
Recovery tank sensor dirty or stuck	Clean or replace sensor	
Little or no solution flow to the floor (Conventional Scrubbing Mode)	Solution tank empty	Fill solution tank
	Solution flow turned off	Turn on solution flow
	Solution supply lines plugged	Flush solution supply lines
Excessive dusting	Brush skirts and dust seals worn, damaged, or out of adjustment	Replace or adjust brush skirts and/or brush seals
	Hopper dust filter clogged	Shake and/or replace dust filter
	Sweep vacuum fan seal damaged	Replace vacuum fan seal
	Sweep vacuum fan failure	Call Tennant service representative
	Thermo-Sentry tripped	Allow Thermo-Sentry to cool
Poor sweeping performance	Worn brush bristles	Replace brushes
	Brush pressure set too light	Increase brush pressure
	Main brushes not properly adjusted	Adjust brushes
	Debris caught in main brush drive mechanism	Remove debris from main brush drive mechanism
	Main and/or side brush drive failure	Call Tennant service representative
	Hopper is full	Empty hopper
	Hopper lip skirts worn or damaged	Replace lip skirts
	Improper main brushes	Call Tennant service representative
Poor scrubbing performance	Improper detergent or brushes	Call Tennant service representative
	Solution tank empty	Fill solution tank
	Debris caught on main brushes	Remove debris

## OPERATION

Problem	Cause	Remedy
Poor scrubbing performance	Worn main brushes	Replace brushes
	Brush pressure set too light	Increase brush pressure
FaST System does not operate	FaST button is turned off	Turn on the FaST button
	Clogged FaST-PAK supply hose and/or connector	Soak connector and hose in warm water and clean
	FaST-PAK carton is empty or not connected	Replace FaST-PAK carton and/or connect supply hose
	FaST system is not primed	To prime, operate the FaST solution system for a few minutes
	Clogged filter screen	Drain solution tank, remove and clean filter screen
	Blown fuse	Call Tennant service representative
	Faulty solution pump	Call Tennant service representative
ES System does not operate	<i>ES button</i> is turned off	Turn on <i>ES button</i>
	ES sensor in tank dirty	Clean sensor
	Clogged ES pump filter	Clean ES filter
	Water level in recovery tank too low	Fill recovery tank about half full
	Water level in solution tank too low	Fill solution tank
Sweeping or Scrubbing functions do not turn on	Hopper is up	Completely lower hopper
	Fire in the hopper	Shut off machine. Extinguish fire. If necessary, call emergency personnel.
	Recovery tank full	Press the <i>Scrub vacuum fan/squeegee button</i> for one minute of extended water pickup. Empty recovery tank. ES models: activate the ES system to prevent this.
<b>ec-H2O Model:</b> <i>ec-H2O</i> system indicator light blinks red and the alarm sounds	Mineral deposit build-up in module	Flush module (See <i>ec-H2O</i> MODULE FLUSH PROCEDURE), if indicator light starts flashing within 1–10 seconds, repeat flush procedure. If indicator light starts flashing after a minute of scrubbing, the water may have low conductivity.
	Low water conductivity	Add 8ml of salt to every 40 L of water.
<b>ec-H2O Model:</b> <i>ec-H2O</i> system indicator light solid red	Defective module	Contact Service Center
<b>ec-H2O Model:</b> <i>ec-H2O</i> system indicator light does not turn on	Defective light or module	Contact Service Center
<b>ec-H2O Model:</b> No water flow	Clogged module	Contact Service Center
	Defective solution pump	Replace solution pump
	Clogged filter screen	Clean filter screen



MAINTENANCE

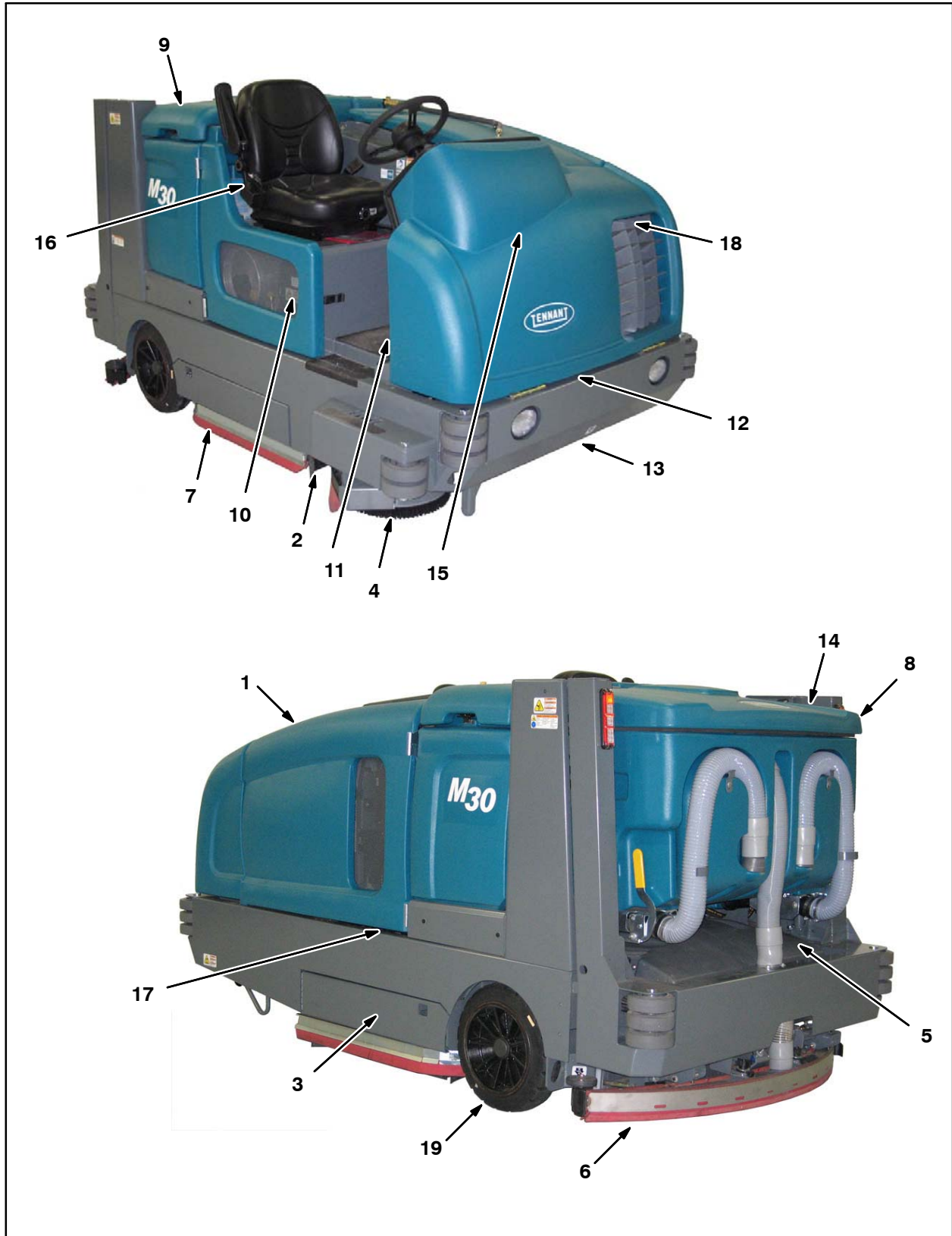

# MAINTENANCE

## MAINTENANCE CHART

The table below indicates the *Person Responsible* for each procedure.

**O = Operator.**

**T = Trained Service Mechanic.**

Interval	Person Resp.	Key	Description	Procedure	Lubricant /Fluid	No. of Service Points
Daily	O	1	Engine	Check oil level	EO	1
				Check coolant level in reservoir	WG	1
	O	10	Hydraulic fluid reservoir	Check fluid level	HYDO	1
	O	8, 9	Tank cover seals	Check for damage or wear	-	3
	O	3	Main brushes	Check for damage and wear	-	2
				Side brush (option)	Check for damage and wear	-
	O	4	Side brush (option)	Check squeegee blade for damage and wear	-	1
				Rear Squeegee Blade	Check for damage and wear	-
	O	6	Rear Squeegee Blade	Check deflection	-	1
				Side Squeegee Blades	Check for damage and wear	-
	O	8	Recovery tank	Clean	-	1
	O	8	Recovery tank, ES mode (option)	Clean ES filter	-	1
	O	9	Solution tank, ES mode (option)	Clean	-	1
O	5	Hopper	Clean hopper, debris screen, and hose	-	1	
20 Hours	O	5	Hopper dust filter	Check for damage, clean, replace if necessary	-	1
50 Hours	O	16	FaST / ec-H2O filter screen	Clean	-	1
	O	3	Main brushes	Rotate front to rear	-	2
	T	3	Main brushes	Check brush pattern and adjust if needed	-	2
	T	13	Front wheel	Torque wheel nuts <b>(after initial 50 hours only)</b>	-	1
	T	15	Battery	Clean and tighten battery cable connections <b>(after initial 50 hours only)</b>	-	1
	T	1	Engine	Check belt tension	-	1

Interval	Person Resp.	Key	Description	Procedure	Lubricant /Fluid	No. of Service Points
100 Hours	T	18	Radiator	Clean core exterior	-	1
	T	18	Hydraulic cooler	Clean core exterior	-	1
	T	1	Engine	Change oil and filter	EO	1
				Drain LPG vaporizer oil buildup	-	1
			Engine, GM (S/N 000000-003999)	Drain oil from electronic pressure regulator (EPR)	-	1
	O	13, 19	Tires	Check for damage	-	3
	T	6	Rear squeegee casters	Lubricate	SPL	2
	T	6	Rear squeegee	Check leveling	-	1
O	2	Scrub head skirt	Check for damage or wear	-	1	
200 Hours	T	12	Front wheel support bearings	Lubricate	SPL	2
	T	1, 17	Torque tube	Lubricate	SPL	4
	T	12	Steering cylinder	Lubricate	SPL	1
	T	1, 18	Radiator hoses and clamps	Check for tightness and wear	-	2
	T	11	Brake pedal	Check adjustment	-	1
	T	14	Hopper lift arm pivots	Lubricate	SPL	2
	T	5	Hopper door pivots	Lubricate	SPL	2
400 Hours	T	1	Engine, GM (S/N 000000-003999)	Clean and re-gap or replace spark plugs	-	4
	T	1	Engine	Replace air filter	-	1
				Replace fuel filter	-	1
T	20	Rear wheel bearings	Check, lubricate, and adjust	SPL	2	
800 Hours	T	10	Hydraulic reservoir	Replace filler cap		1
	T	1	Engine, GM (S/N 000000-003999)	Check timing belt	-	1
	T	-	Hydraulic hoses	Check for wear and damage	-	All
	T	1, 18	Cooling system	Flush	WG	2
	T	13	Propelling motor	Torque shaft nut	-	1
	T	13	Front wheel	Torque wheel nuts	-	1
	T	15	Battery	Clean and tighten battery cable connections	-	1

*NOTE: Change the hydraulic fluid, filter, and suction strainer, indicated (\*), after every 800 hours for machines NOT originally equipped with **TennantTrue** premium hydraulic fluid. (See Hydraulics section).*

**LUBRICANT/FLUID**

EO . . . Engine oil, 5W30 SAE-SG/SH only.

HYDO . **TennantTrue** premium hydraulic fluid or equivalent

WG . . . Water and ethylene glycol anti-freeze, -34° C (-30° F)

SPL . . . Special lubricant, Lubriplate EMB grease (Tennant part number 01433-1)

*NOTE: More frequent maintenance intervals may be required in extremely dusty conditions.*

## MAINTENANCE

The table below indicates the *Person Responsible* for each procedure.

**O = Operator.**

**S = Trained Service Mechanic.**

Interval	Person Resp.	Key	Description	Procedure	Lubricant/ Fluid	No. of Service Points
1000 Hours	T	16	FaST system filters	Replace	–	2
	T	1	Engine, Mitsubishi (S/N 004000– )	Replace spark plugs	–	4
	T	1	Engine	Inspect PCV system	–	1
	T	1, 19	Radiator hoses	Check for cracks or deterioration	–	2
1200 Hours	T	10	Hydraulic reservoir	* Replace fluid filter	–	1
2000 Hours	T	1	Engine, GM (S/N 000000–003999)	Replace timing belt	–	1
2400 Hours	T	10	Hydraulic reservoir	* Change hydraulic fluid	HYDO	1
				* Replace strainer outlet		1
5000 Hours	T	1	Engine, Mitsubishi (S/N 004000– )	Replace camshaft and balance shaft belts	–	2

*NOTE: Change the hydraulic fluid, filter, and suction strainer, indicated (\*), after every 800 hours for machines NOT originally equipped with **TennantTrue** premium hydraulic fluid. (See Hydraulics section).*

### LUBRICANT/FLUID

EO . . . . Engine oil, 5W30 SAE–SG/SH only.

HYDO . **TennantTrue** premium hydraulic fluid or equivalent

WG . . . Water and ethylene glycol anti-freeze, –34° C (–30° F)

SPL . . . Special lubricant, Lubriplate EMB grease (Tennant part number 01433–1)

*NOTE: More frequent maintenance intervals may be required in extremely dusty conditions.*



**LUBRICATION**

**FOR SAFETY: Before leaving or servicing machine, stop on level surface, set parking brake, turn off machine, and remove key.**

**ENGINE OIL**

Check the engine oil level daily. Change the oil and oil filter after every 100 hours of operation.



Fill the engine with oil until the oil is between the indicator marks on the dipstick. DO NOT fill past the top indicator mark.

The engine oil capacity for **GM engines** (machines serial number 003999 and below) is 3.5 L (3.7 qt) with oil filter.

The engine oil capacity for **Mitsubishi engines** (machines serial number 004000 and above) is 4.7 L (5 qt) with oil filter.

**SQUEEGEE CASTER BEARINGS**

Lubricate the squeegee caster bearings after every 100 hours of operation.

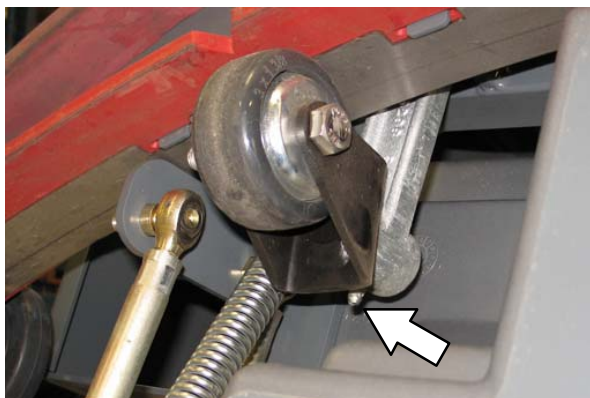
**FRONT WHEEL SUPPORT BEARING**

Lubricate the front wheel support bearings after every 200 hours of operation. Both front wheel support grease fittings are located underneath the frame support plate.

**STEERING CYLINDER BEARING**

Lubricate the steering cylinder after every 200 hours of operation. The steering cylinder bearing is located next to the front wheel support.

**REAR WHEEL BEARINGS**

Inspect the rear wheel bearings for seal damage, and repack and adjust every 400 hours of operation. Use Lubriplate EMB grease (Tennant part number 01433-1).

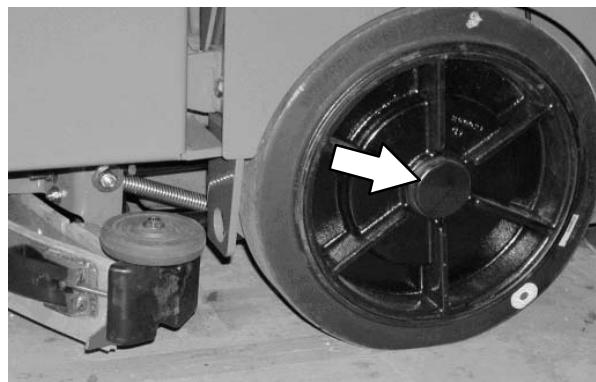

# MAINTENANCE

## HOPPER LIFT ARM PIVOTS

Lubricate the hopper lift arm pivots after every 200 hours of operation.



## HOPPER DOOR PIVOTS

Lubricate the hopper door pivots after every 200 hours of operation.



## TORQUE TUBES

Lubricate the torque tubes after every 200 hours of operation. The torque tube grease fittings on the operator side of the machine are located beneath the fuel tank.



On the other side of the machine the torque tube grease fittings are located beneath the propel pump.

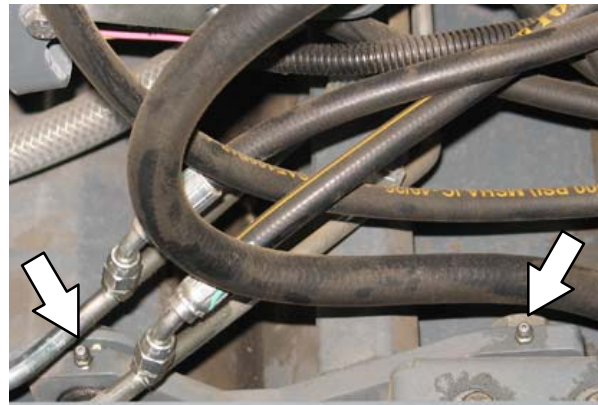

**HYDRAULICS**

Check the hydraulic fluid level at operating temperature daily. The hydraulic fluid level should be between the two lines on the hydraulic gauge. The hopper must be down when checking hydraulic fluid level.

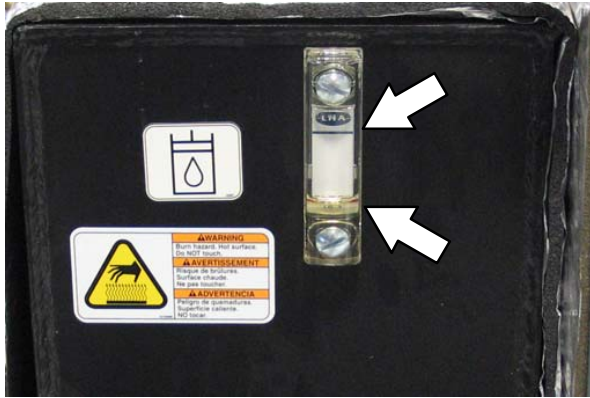

**ATTENTION! Do not overfill the hydraulic fluid reservoir or operate the machine with a low level of hydraulic fluid in the reservoir. Damage to the machine hydraulic system may result.**

Drain and refill the hydraulic fluid reservoir with new **TennantTrue** premium hydraulic fluid after every 2400 hours of operation. Machines have a blue colored drop (left photo) on the hydraulic fluid label if originally equipped with **TennantTrue** premium hydraulic fluid.

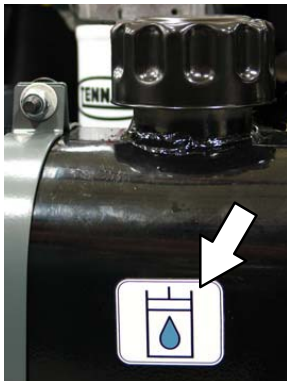

**TennantTrue Fluid**

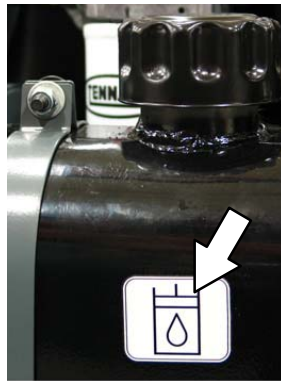

**Previous Fluid**

Replace the filler cap after every 800 hours of operation. Apply a light film of hydraulic fluid onto the filler cap gasket before installing the cap onto the reservoir.



Replace the hydraulic fluid filter after every 1200 hours of operation or if the hydraulic reservoir gauge is in the yellow/red zone when the reservoir hydraulic fluid is approximately 32° C (90° F).

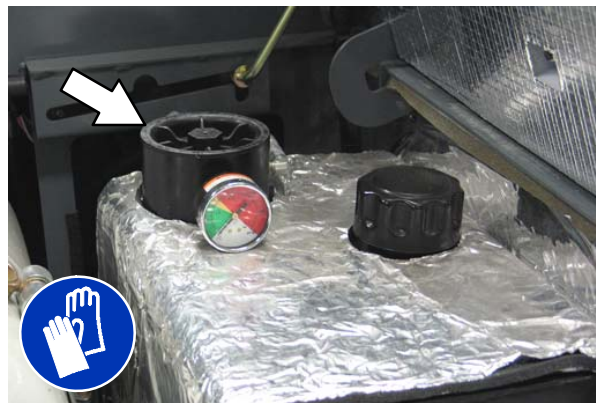

Replace the hydraulic strainer outlet after every 2400 hours of operation.



# MAINTENANCE

## HYDRAULIC FLUID

There are three fluids available for different ambient air temperature ranges:

TennantTrue premium hydraulic fluid (Extended Life)			
Part Number	Capacity	ISO Grade Viscosity Index (VI)	Ambient Air Temperature Ranges
1057710	3.8 L (1 gal)	ISO 100 VI 126 or higher	19° C (65° F) or higher
1057711	19 L (5 gal)		
1069019	3.8 L (1 gal)	ISO 68 VI 155 or higher	7 to 43° C (45 to 110° F)
1069020	19 L (5 gal)		
1057707	3.8 L (1 gal)	ISO 32 VI 163 or higher	16° C (60° F) or lower
1057708	19 L (5 gal)		

If using a locally-available hydraulic fluid, be sure the specifications match Tennant hydraulic fluid specifications. Substitute fluids can cause premature failure of hydraulic components.

**ATTENTION! Hydraulic components depend on system hydraulic fluid for internal lubrication. Malfunctions, accelerated wear, and damage will result if dirt or other contaminants enter the hydraulic system.**

## HYDRAULIC HOSES

Check the hydraulic hoses after every 800 hours of operation for wear or damage.

**FOR SAFETY: When servicing machine, use cardboard to locate leaking hydraulic fluid under pressure.**

High pressure fluid escaping from a very small hole can almost be invisible, and can cause serious injuries.

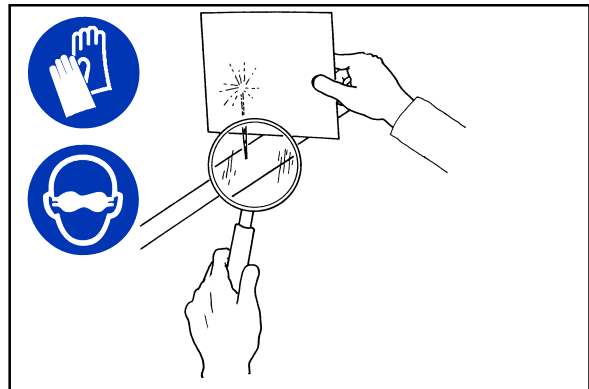

00002

Consult a physician immediately if injury results from escaping hydraulic fluid. Serious infection or reaction can occur if proper medical treatment is not given immediately.

Contact a mechanic or supervisor if a leak is discovered.



**ENGINE**

**FOR SAFETY: Before leaving or servicing machine, stop on level surface, set parking brake, turn off machine, and remove key.**

**COOLING SYSTEM**

**FOR SAFETY: When servicing machine, avoid contact with hot engine coolant. Do not remove cap from radiator when engine is hot. Allow engine to cool.**

Check the coolant level in the reservoir daily. The coolant level must be between the indicator marks when the engine is cold. Refer to the coolant manufacture for water/coolant mixing instructions.

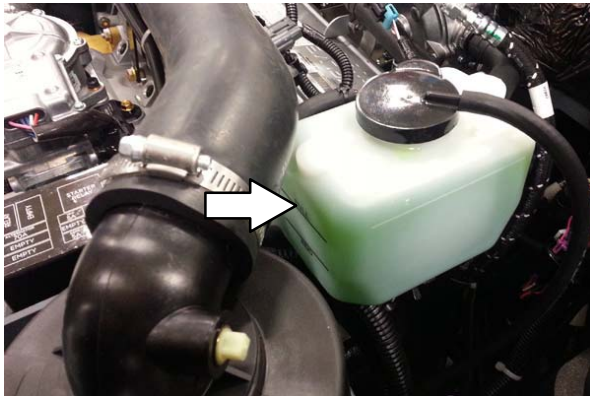

Flush the radiator and the cooling system after every 800 hours of operation.

Check the radiator hoses and clamps after every 200 hours of operation. Tighten loose clamps. Replace damaged hoses and clamps.

Check the radiator hoses for cracks and deterioration after every 1000 hours of operation.

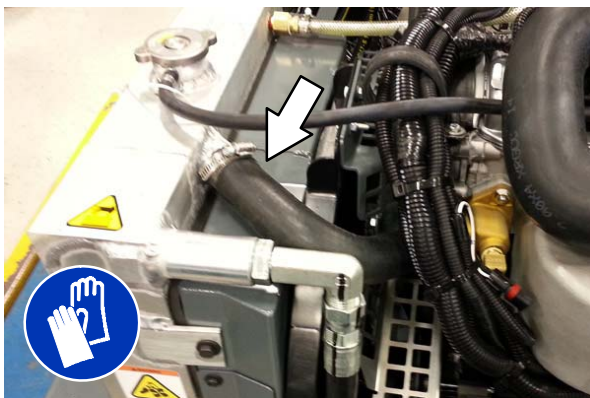

Check the radiator core exterior and hydraulic cooler fins for debris after every 100 hours of operation. Blow or rinse all dust through the grille and radiator fins, in the opposite direction of normal air flow. Be careful to not bend the cooling fins when cleaning. Clean thoroughly to prevent the fins from becoming encrusted with dust. To avoid cracking the radiator, allow the radiator and cooler fins to cool before cleaning.

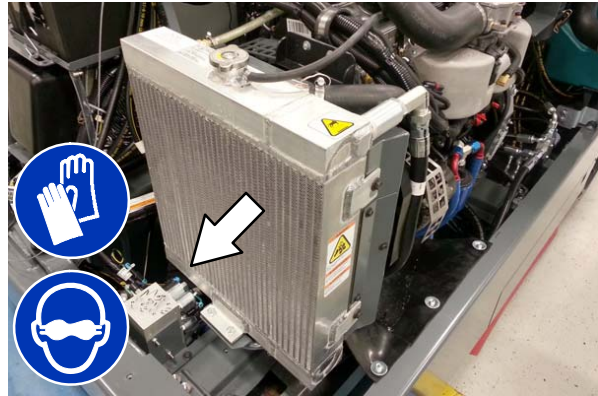

**FOR SAFETY: When servicing machine, wear eye and ear protection when using pressurized air or water.**

**AIR FILTER**

Replace the air filter after every 400 hours of operation.

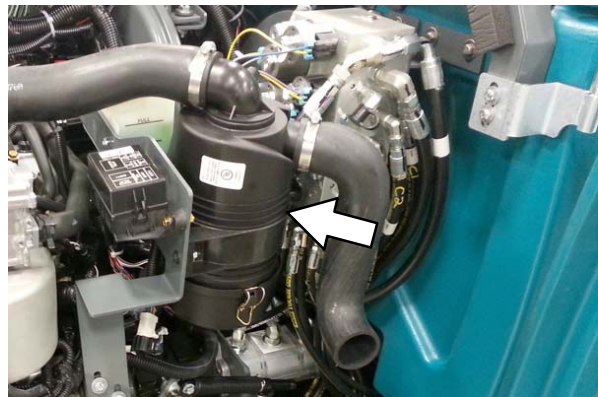

## MAINTENANCE

### FUEL FILTER (LPG)

Replace the LPG fuel filter after every 400 hours of operation.

Disassemble the fuel lock off valve to access the LPG fuel filter.

**FOR SAFETY: When servicing machine, keep flames and sparks away from fuel system service area. Keep area well ventilated.**

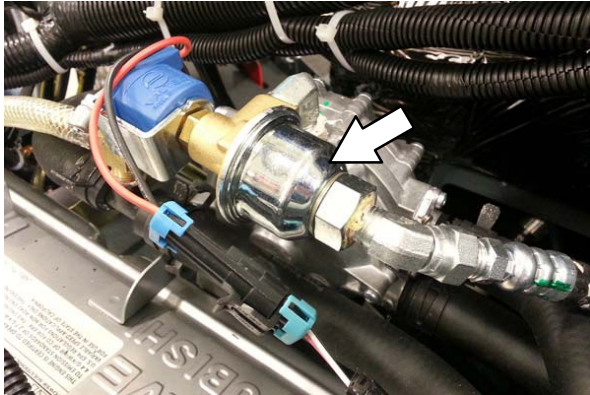

### ELECTRONIC PRESSURE REGULATOR (LPG) (S/N 000000 – 003999)

Remove the sensor and drain the oil from the LPG electronic pressure regulator after every 100 hours of operation.

**FOR SAFETY: When servicing machine, keep flames and sparks away from fuel system service area. Keep area well ventilated.**

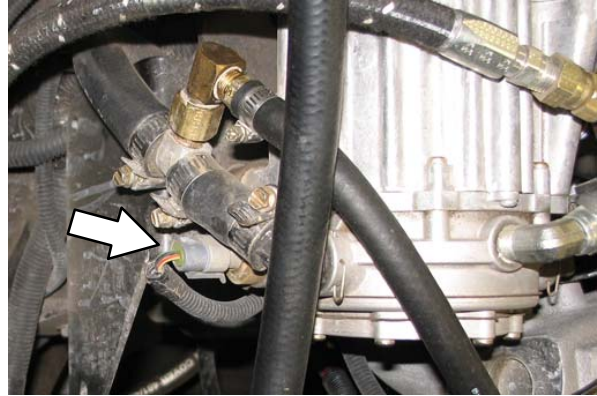

### FUEL FILTER (Gasoline)

Replace the gasoline fuel filter after every 400 hours of operation.

**FOR SAFETY: When servicing machine, keep flames and sparks away from fuel system service area. Keep area well ventilated.**



### LPG VAPORIZER

Drain oil buildup in the LPG vaporizer after every 100 hours of operation.

**FOR SAFETY: When servicing machine, keep flames and sparks away from fuel system service area. Keep area well ventilated.**





**ENGINE BELT**

Check the belt tension after every 50 hours of operation. Adjust tension as necessary. Proper belt tension is 13 mm (0.50 in) from a force of 4 to 5 kg (8 to 10 lb) applied at the mid-point of the longest span.

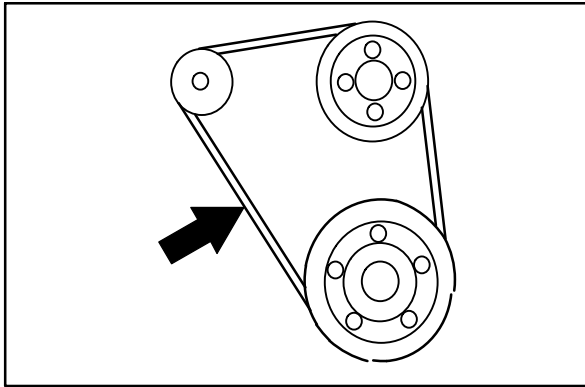

**WARNING:** Moving belt and fan. Keep away.

**PCV SYSTEM**

Inspect the PCV system after every 1000 hours of operation.



**SPARK PLUGS – GM ENGINES  
(S/N 000000 – 003999)**

Clean or replace, and set the gap of the spark plugs after every 400 hours of operation. The proper spark plug gap is 1 mm (0.042 in).

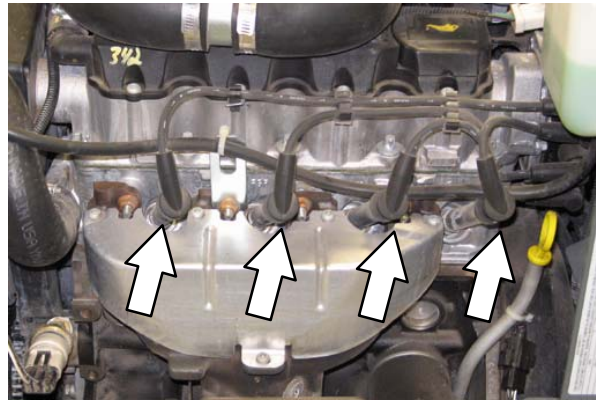

**SPARK PLUGS – MITSUBISHI ENGINES  
(S/N 004000 – )**

Replace the spark plugs after every 1000 hours of operation.

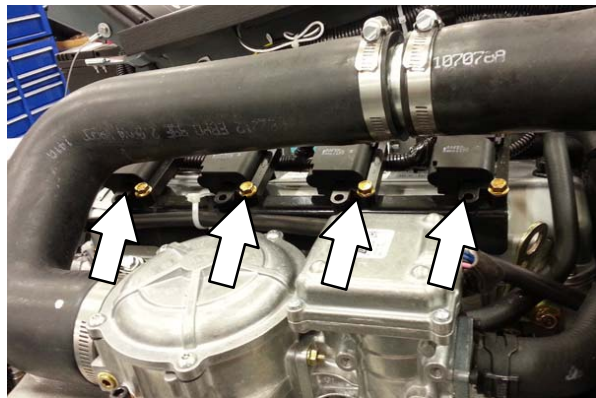

## MAINTENANCE

### TIMING BELT – GM ENGINES (S/N 000000 – 003999)

Check the timing belt after every 800 hours of operation.

Replace the timing belt after every 2000 hours of operation.

### CAMSHAFT AND BALANCE SHAFT BELTS – MITSUBISHI ENGINES (S/N 004000 – )

Replace the camshaft and balance shaft belts after every 5000 hours of operation.

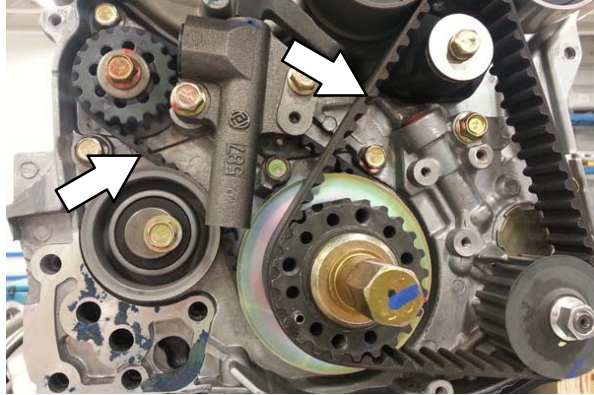

## BATTERY

Clean and tighten the battery connections after the first 50 hours of operation and after every 800 hours after that. Do not remove the vent plugs from the battery or add water to the battery.

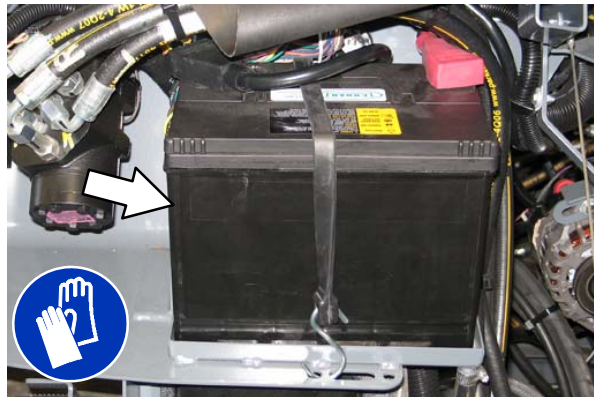

**FOR SAFETY:** When servicing machine, avoid contact with battery acid.

## FUSES AND RELAYS

### RELAY PANEL FUSES AND RELAYS

*Fuses* are one-time protection devices designed to protect the wire harness by stopping the flow of current in the event of a circuit overload. *Relays* switch the electrical power going to the machine electrical systems on/off. Remove the relay panel cover to access *fuses* and *relays*.

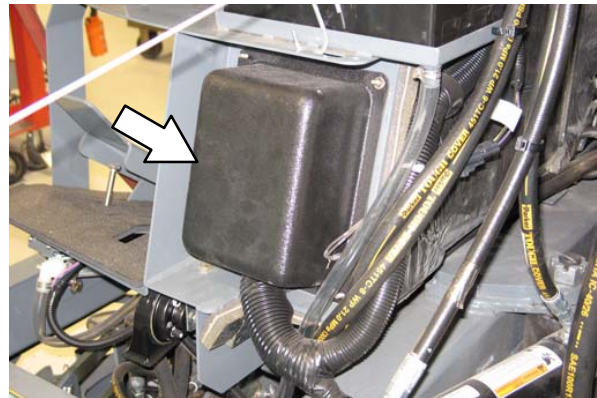

**NOTE:** Always replace a fuse with a fuse of the same amperage. Extra 15 Amp fuses are provided inside the relay panel drawer on the relay panel.

Refer to the diagram below for locations of the *fuses* and *relays* on the relay panel.

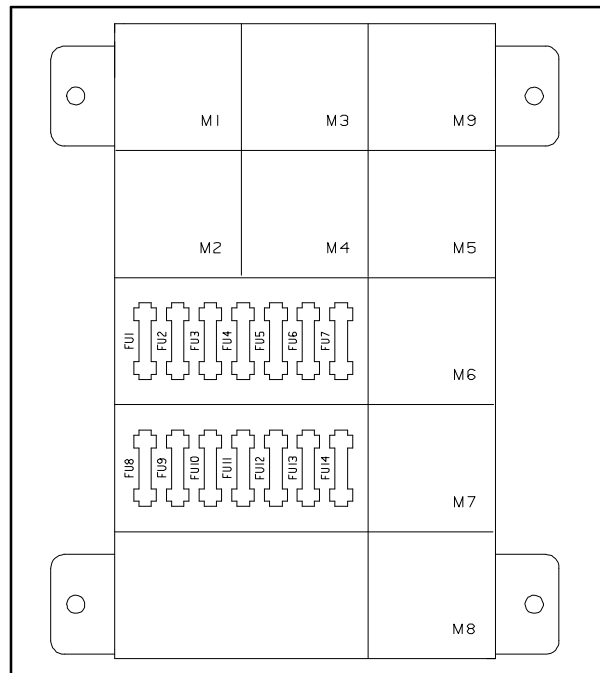



Refer to the table below for the *fuses* and circuits protected.

Fuse	Rating	Circuit Protected
FU1	15 A	Auxiliary Relays/Engine Controls
FU2	15 A	Shaker
FU3	15 A	Horn
FU4	15 A	Not Used
FU5	15 A	Scrub Vacuum/Main Brush/Squeegee Down/Hopper Up
FU6	15 A	Enable/Side Brush/Sweep Vacuum
FU7	15 A	Solution/Hopper Latch and Door/Auto Fill/Reverse/Shaker
FU8	15 A	ES/FaST/Detergent/Hopper Down/Spray Wand
FU9	15 A	Lights
FU10	15 A	Unswitched B+ for controller board
FU11	15 A	Not Used: Options
FU12	15 A	Spray Nozzle Pump
FU13	15 A	AC/Heater Option
FU14	15 A	Not Used

-	20 A	ec-H2O (near ignition switch)
---	------	-------------------------------



Refer to the table below for the *relays* and circuits controlled.

Relay	Rating	Circuit Controlled
M1	12 VDC, 40 A	Auxiliary 1
M2	12 VDC, 40 A	Auxiliary 2
M3	12 VDC, 40 A	Shaker
M4	12 VDC, 40 A	Reverse
M5	12 VDC, 40 A	Horn
M6	12 VDC, 40 A	Shutdown
M7	12 VDC, 40 A	Starter
M8	12 VDC, 40 A	Auxiliary 3
M9	12 VDC, 40 A	Spare

## ENGINE HARNESS FUSES AND RELAYS

The *engine harness fuses and relays* are located in the fuse box inside the engine compartment. Refer to the fuse box cover for locations of engine harness fuses and relays.



**NOTE:** Always replace a fuse with a fuse of the same amperage.

## OPTIONAL RELAYS

The optional spray nozzle or pressure wand relay is located behind the battery. The optional FaST scrubbing system relay is located behind the seat.

Relay	Rating	Circuit Controlled
-	12 VDC, 40 A	Spray Wand
-	12 VDC, 40 A	Pressure Washer
-	12 VDC, 40 A	FaST

## CIRCUIT BREAKERS (ec-H2O)

Circuit breakers are resettable electrical circuit protection devices that stop the flow of current in the event of a circuit overload. Once a circuit breaker is tripped, allow breaker to cool and then press the reset button to manually reset the breaker.

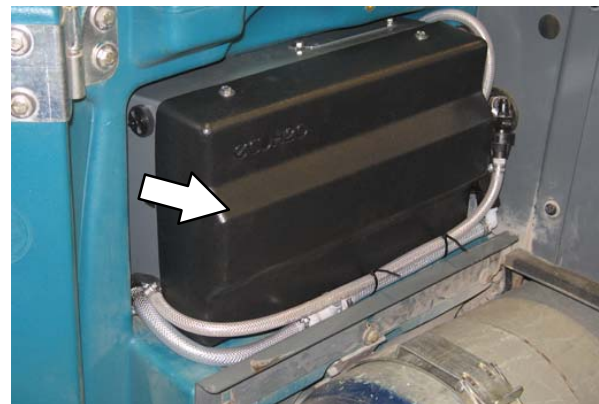

## MAINTENANCE

### CLEANING THE HOPPER DUST FILTER

Shake the dust filter before emptying the hopper and at the end of every shift. Inspect and clean the filter after every 20 hours of operation. Replace damaged dust filters.

*NOTE: The dust filter may need to be cleaned at more frequent intervals if the machine is used in extremely dusty conditions.*

Use one of the following methods to clean the dust filter:

**SHAKING**—Press the *filter shaker button*.

**TAPPING**—Tap the filter, with the dirty side down, gently on a flat surface. **Do not damage the edges of the filter.** The filter will not seal properly in the filter frame if the edges of the filter are damaged.

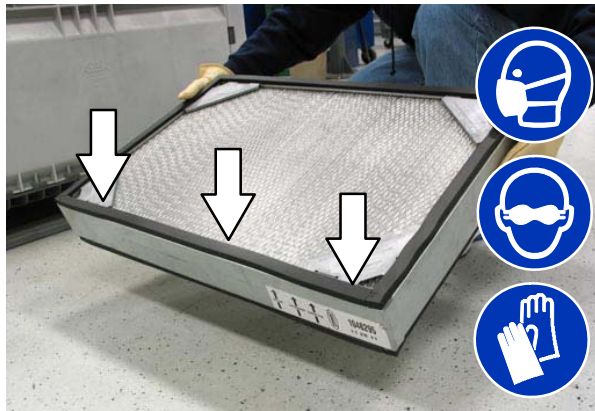

**AIR**—Always wear eye protection when using compressed air. Blow air through the dust filter opposite the direction of the arrows. Never use more than 690 kPa (100 psi) of air pressure and never hold the nozzle closer than 50 mm (2 in) to the filter. This may be done with the dust filter in the machine.

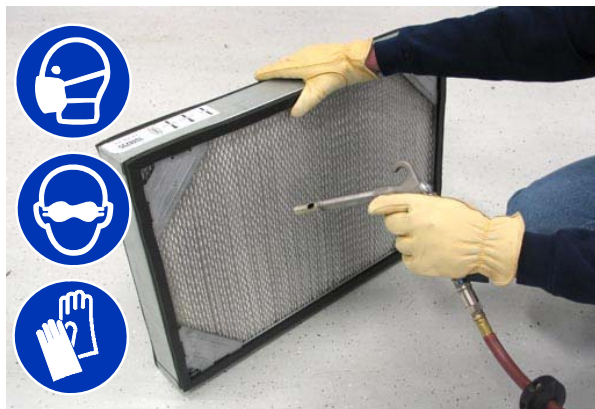

**WATER**—Rinse the dust filter with a low pressure garden hose through the dust filter opposite the direction of the arrows.



*NOTE: If water is used to clean the dust filter, be sure the filter is completely dry before reinstalling it into the hopper. **Do Not** reinstall a wet dust filter.*

### THERMO-SENTRY

The Thermo-Sentry, located inside the hopper, senses the temperature of the air pulled up from the hopper. If there is a fire in the hopper, the Thermo-Sentry stops the vacuum fan and cuts off the air flow. The Thermo-Sentry automatically resets after cooling down.

**MAIN BRUSHES**

**FOR SAFETY: Before leaving or servicing machine, stop on level surface, set parking brake, turn off machine, and remove key.**

Check the main brushes daily for tangled wire or string, wear, and damage.

Replace the brushes when they no longer clean effectively.

Rotate the brushes from front to rear after every 50 hours of machine operation for maximum brush life and best scrubbing performance.

*NOTE: Replace brushes in sets of two. Otherwise one scrub brush may scrub more aggressively than the other.*

**REPLACING OR ROTATING THE MAIN BRUSHES**

The front brush can be accessed on the left side of the machine and rear brush can be accessed on the right side of the machine.

1. Raise the scrub head.

**FOR SAFETY: Before leaving or servicing machine, stop on level surface, set parking brake, turn off machine, and remove key.**

2. Open the outer brush doors.



3. Open the inner brush doors.



4. Remove the brush idler plates.

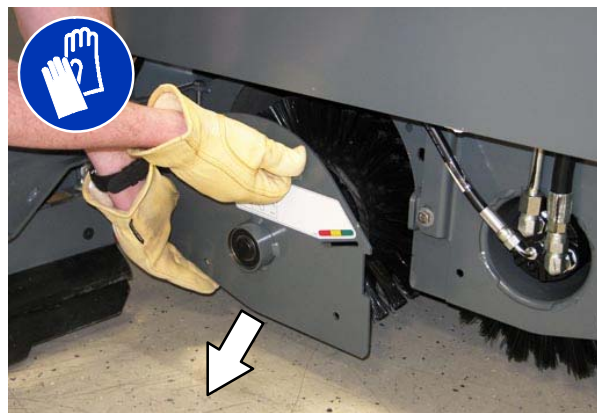

5. Pull the brushes out from the scrub head.





## MAINTENANCE

6. Install the new or rotated brushes by pushing down on the ends while sliding them onto the drive motor hubs.



7. If rotating the brushes, always rotate the front with the back so that they wear evenly. They may be rotated end-for-end as well.

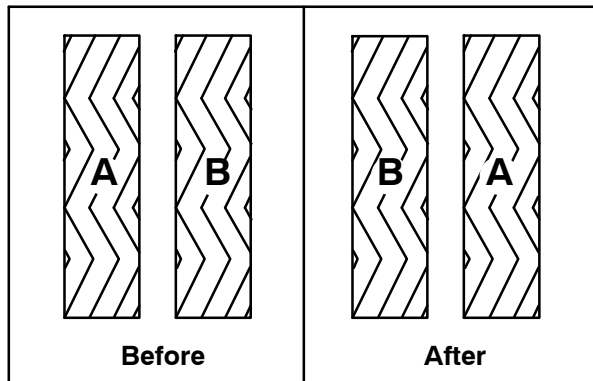

8. Reinstall the brush idler plates.
9. Close the inner and outer brush doors.
10. Check the brush pattern and adjust if needed after rotating them. Refer to *CHECKING AND ADJUSTING THE MAIN BRUSH PATTERN*.



## CHECKING THE MAIN BRUSH PATTERN

1. Apply chalk, or a similar marking material, to a smooth and level section of the floor.

*NOTE: If chalk or other material is not available, allow the brush to spin on the floor for two minutes. A polish mark will remain on the floor.*

2. Raise the scrub head, then position the brushes over the chalked area.
3. Set the parking brake.
4. Press the *1-STEP Sweep button* to lower the scrub head. Set the brush pressure to the lowest setting and allow the brushes to operate for 15 to 20 seconds. Keep the scrub head in one spot in the chalked area.
5. Raise the scrub head, release the parking brake, and drive the machine away from the chalked area.

**FOR SAFETY: Before leaving or servicing machine, stop on level surface, set parking brake, turn off machine, and remove key.**

6. Observe the brush patterns. If the brush pattern is the same width across the entire length of each brush and both brushes are the same width, no adjustment is necessary.

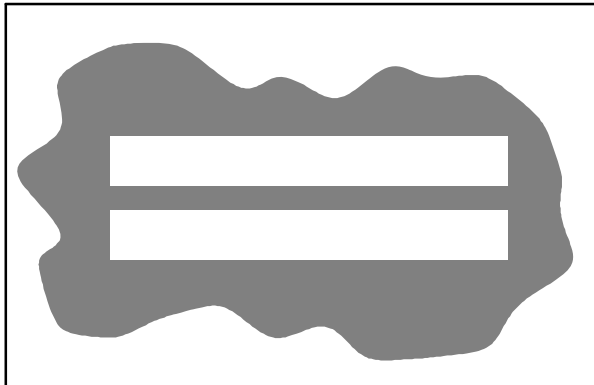

10355

7. If the brush patterns are tapered, see *ADJUSTING THE MAIN BRUSH TAPER* section of this manual.

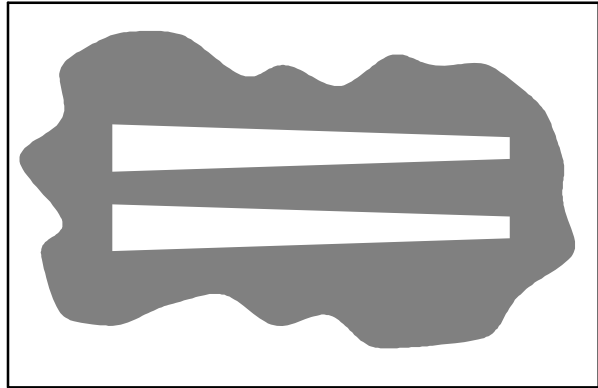

10652

8. The brush patterns should be 50 to 75 mm (2 to 3 in) wide with the brushes in the lowered position and both patterns should be the same width. If the width of the brushes is not the same, see *ADJUSTING THE MAIN BRUSH WIDTH* section of this manual.

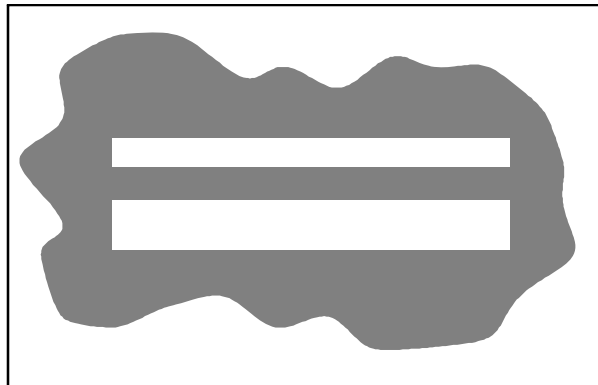

10653

## MAINTENANCE

### ADJUSTING THE MAIN BRUSH TAPER

1. Loosen the four mounting bolts on the brush drive housing.

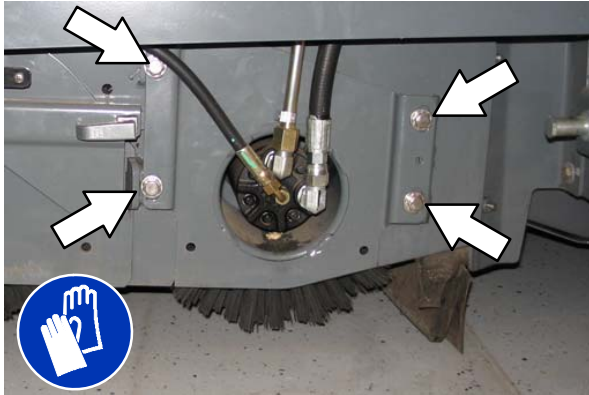

2. Move the brush drive housing up to decrease the pattern width on that side of the scrub head or down to increase the pattern width on that side of the scrub head.
3. Tighten the mounting bolts.
4. Recheck the pattern. Readjust if necessary.

### ADJUSTING THE MAIN BRUSH WIDTH

1. Adjust the length of the drag links on both sides of the scrub head. Lengthen the drag links to increase the rear brush pattern width. Shorten the drag links to increase the front brush pattern. Always adjust the nut on each drag link an equal number of turns.

*NOTE: Two full turns of the drag link adjustment bolt will change the brush pattern approximately 25 mm (1 in).*



2. Recheck the pattern. Readjust if necessary.

## SIDE BRUSH (OPTION)

**FOR SAFETY: Before leaving or servicing machine, stop on level surface, set parking brake, turn off machine, and remove key.**

Check the side brush daily for wear or damage. Remove any tangled string or wire from the side brush or side brush drive hub.

### REPLACING THE SIDE BRUSH

Replace the brush when it no longer cleans effectively or when the bristles are worn down to the yellow indicators.

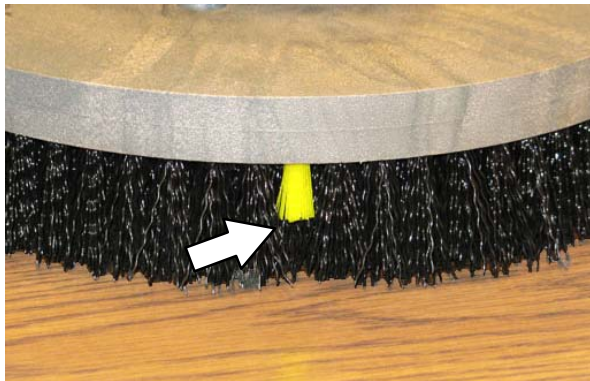

1. If necessary, raise the side brush.
2. Turn the brush until the spring handles are visible through the access hole in the side brush assembly.
3. Squeeze the spring handles and let the side brush drop to the floor.

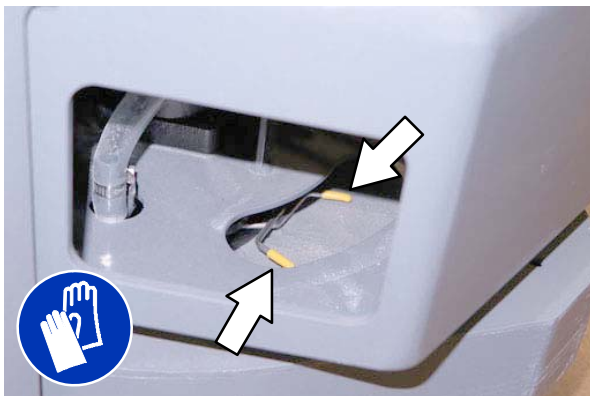

4. Remove the side brush from underneath the side brush assembly.

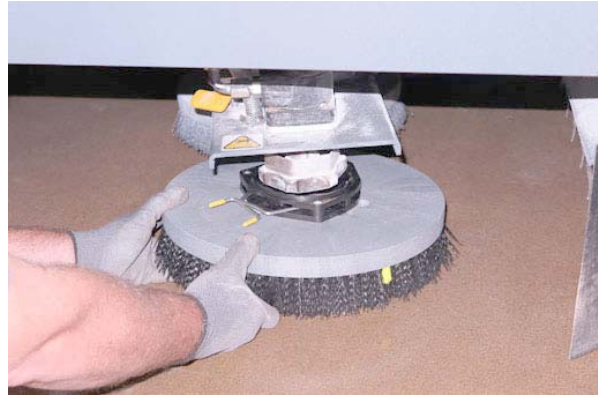

5. Set the brush spring open on the new brush to make installation easier.

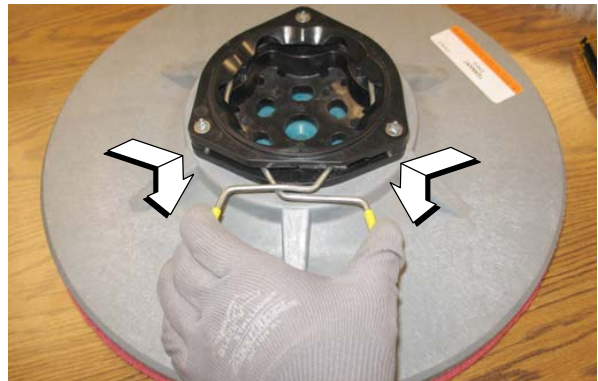

6. Place the new side brush underneath the side brush assembly and lift the side brush up onto the side brush hub until the brush locks onto the hub.

## FaST SYSTEM

### REPLACING THE FaST-PAK CARTON

**FOR SAFETY: Before leaving or servicing machine, stop on level surface, set parking brake, turn off machine, and remove key.**

1. Open the side access door.
2. Slide the seat completely forward.
3. Squeeze the button on the FaST supply hose connector, then pull the empty FaST-PAK carton out from the compartment and discard.

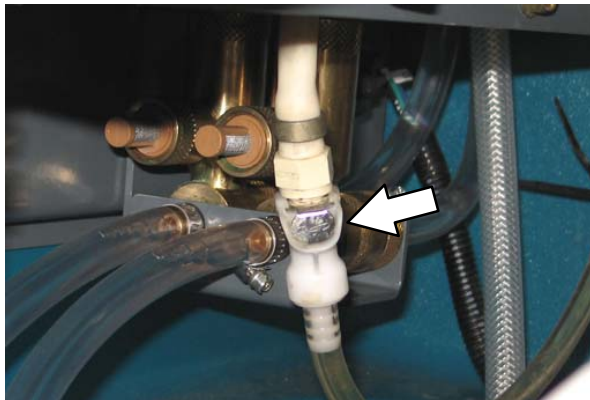

4. Remove the perforated knock outs from the new FaST-PAK carton. Do Not remove the bag from the carton. Pull out the hose connector located on the bottom of the bag and remove the hose cap from the connector.

*NOTE: The FaST-PAK Floor Cleaning Concentrate is specially designed for use with the FaST system scrubbing application. NEVER use a substitute. Other cleaning solutions may cause FaST system failure.*

5. Slide the FaST-PAK carton into the FaST-PAK bracket.
6. Connect the FaST supply hose to the FaST-PAK hose connector.
7. Scrub with the FaST system for a few minutes to allow the detergent to reach maximum foaming.

### CLEANING THE FaST SUPPLY HOSE CONNECTOR

Soak the connector in warm water if detergent buildup is visible. When a FaST-PAK carton is not installed, store the supply hose connector on the storing plug to prevent the hose from clogging.

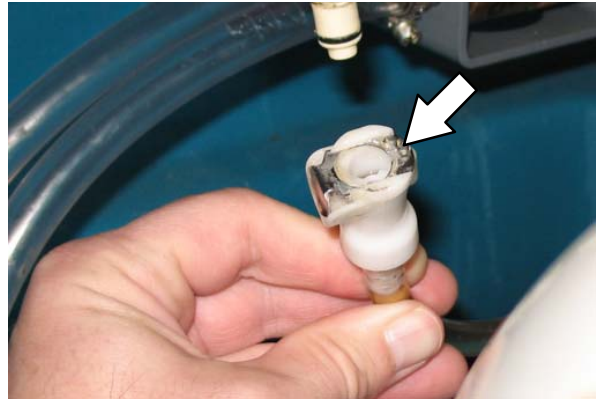

### CLEANING THE FaST SYSTEM FILTER SCREEN

The FaST system filter screen filters water from the solution tank as the water flows into the FaST system.

Remove the filter screen bowl and clean the filter screen after every 50 hours of operation. Empty the solution tank before removing the filter.

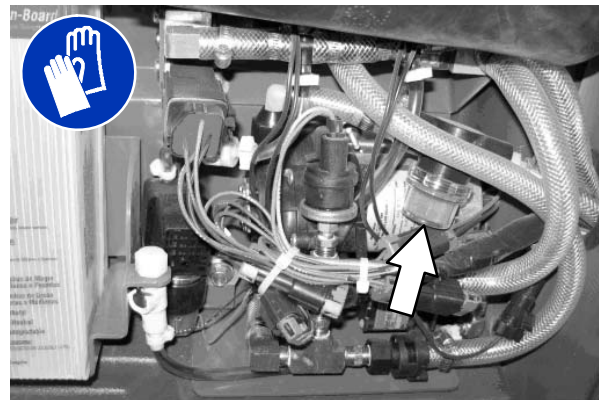



**REPLACING THE FaST SYSTEM FILTERS**

Replace the FaST system filters after every 1000 hours of operation. Empty the solution tank before replacing the filters.

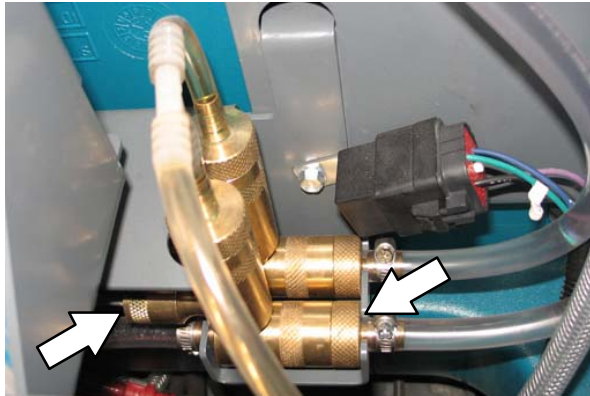

**ec-H2O MODULE FLUSH PROCEDURE**

This procedure is only required when an alarm sounds and the *ec-H2O* system indicator light begins to blink red.

**FOR SAFETY: Before leaving or servicing machine, stop on level surface, set parking brake, turn off machine.**

1. Remove both flush hoses from the storage bag located behind the operator seat.
2. Lock the operator seat cover open.

3. Disconnect the *ec-H2O* system intake hose from the solution supply hose and connect the intake flush hose (gray connector) to the *ec-H2O* system intake hose.



4. Disconnect the *ec-H2O* system outlet hose from the hose to the scrub head and connect the outlet flush hose (black connector) to the *ec-H2O* system outlet hose.



5. Place the *ec-H2O* system intake hose into a container containing 5 gallons (19 liters) of white or rice vinegar. Place the outlet hose into an empty container.



## MAINTENANCE

6. Turn the key to the on position without starting the engine.
7. Press and release the *ec-H2O module flush switch* to start the flush cycle.

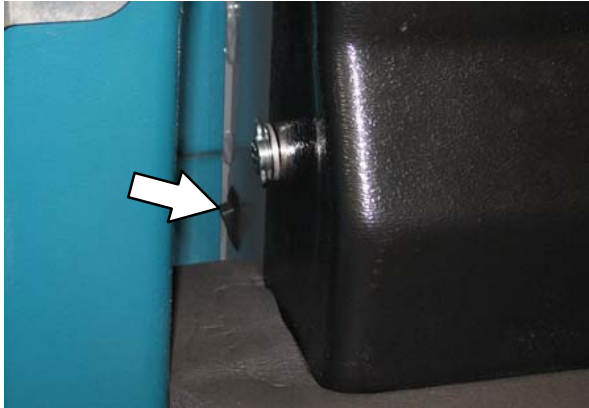

### CLEANING THE *ec-H2O* FILTER SCREEN

Remove and clean the *ec-H2O* filter screen after every 50 hours of operation.

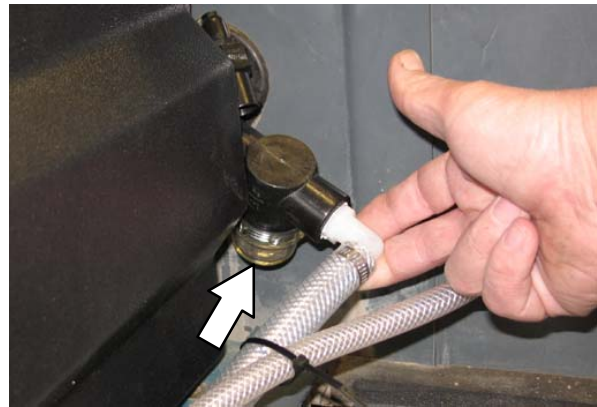

**NOTE:** The module will automatically shut off when the flush cycle is complete (approx. 7 minutes). The module must run the full 7 minute cycle in order to reset the system indicator light and alarm.

8. After the 7 minute flush cycle, remove the siphon hose from the container of vinegar and place the siphon hose into a container of cool clean water. Press the flush switch again to rinse out any remaining vinegar from the module. After 1–2 minutes, press the flush switch to turn off the module.
9. Disconnect the flush hoses from the *ec-H2O* system intake hose and outlet hose and return the flush hoses to the storage bag.
10. Reconnect *ec-H2O* intake and outlet hoses. If the *ec-H2O* system indicator light continues to flash, repeat the flush procedure. If the problem persists, contact an Authorized Service Center.
11. Close the operator seat cover.

**SQUEEGEE BLADES**

**FOR SAFETY: Before leaving or servicing machine, stop on level surface, set parking brake, turn off machine, and remove key.**

Check the squeegee blades for damage and wear daily. When the blades become worn, rotate the blades end-for-end or top-to-bottom to a new wiping edge. Replace blades when all edges are worn.

Check the deflection of the squeegee blades daily or when scrubbing a different type of surface. Check the leveling of the rear squeegee every 100 hours of operation.

**REPLACING (OR ROTATING) THE REAR SQUEEGEE BLADES**

1. Lower the scrub head.
2. Disconnect the vacuum hose from the rear squeegee assembly.

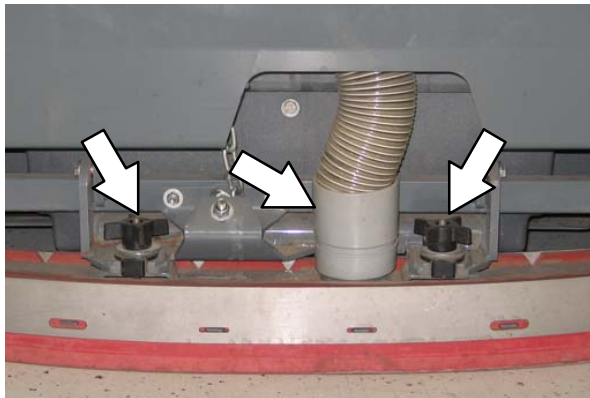

3. Remove both mounting knobs from the rear squeegee assembly.
4. Turn on the machine, raise the scrub head, and turn off the machine.
5. Remove the rear squeegee assembly from the machine.

6. Loosen the rear retaining band tension latch and open the retaining band.

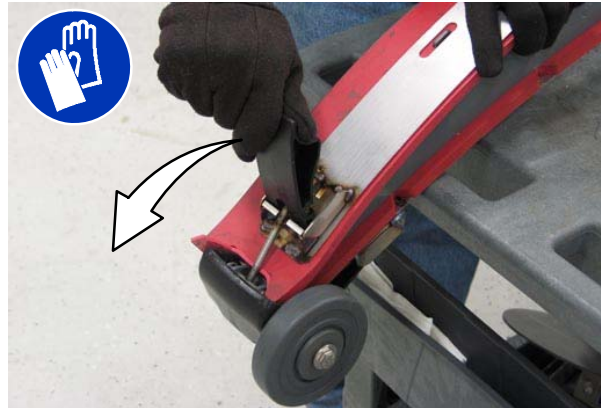

7. Remove the rear squeegee.





## MAINTENANCE

8. Install the new rear squeegee blade or rotate the existing blade to the new edge. Be sure all the holes in the squeegee blade are hooked onto the tabs.



9. Reinstall the rear retaining band aligning the tabs with the holes.



10. Tighten the rear retaining band tension latch.
11. Loosen the front retaining band tension latch and open the retaining band.



12. Remove the front squeegee.



13. Install the new front squeegee blade or rotate the existing blade to the new edge. Be sure the holes in the squeegee blade are hooked onto the tabs.





14. Reinstall the front retaining band aligning the tabs with the notches.



15. Tighten the front retaining band tension latch.
16. Reinstall the rear squeegee assembly onto the machine.
17. Check and adjust the rear squeegee if necessary. Refer to *ADJUSTING THE REAR SQUEEGEE BLADE DEFLECTION* and *LEVELING THE REAR SQUEEGEE* sections of this manual.

## REPLACING OR ROTATING THE SIDE SQUEEGEE BLADES

1. If necessary, raise the scrub head.

**FOR SAFETY: Before leaving or servicing machine, stop on level surface, set parking brake, turn off machine, and remove key.**

2. Open the outer brush doors.
3. Unhook the latch on the side squeegee retaining band from the side squeegee assembly.

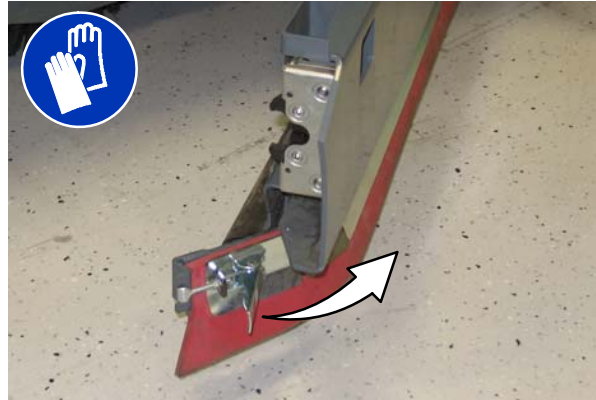

4. Remove the retaining band from the side squeegee assembly.



## MAINTENANCE

5. Remove the side squeegee blade. If the outer edge of the squeegee blade is not worn, rotate the squeegee blade with the blade from the other side of the machine. Discard the squeegee blade if both edges are worn.

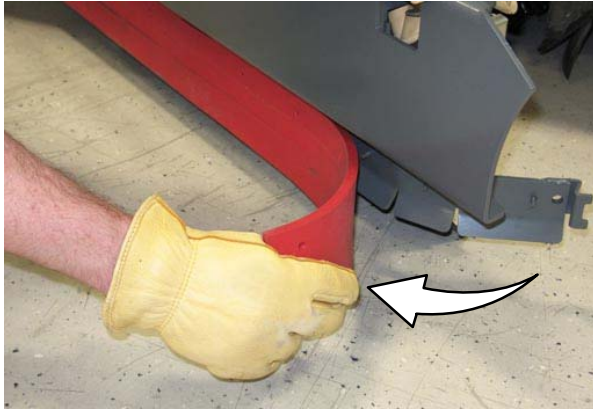

6. Install the new or rotated squeegee blades.



7. Reattach the side squeegee retaining band to the side squeegee assembly.



8. Hook the latch on the side squeegee retaining band.

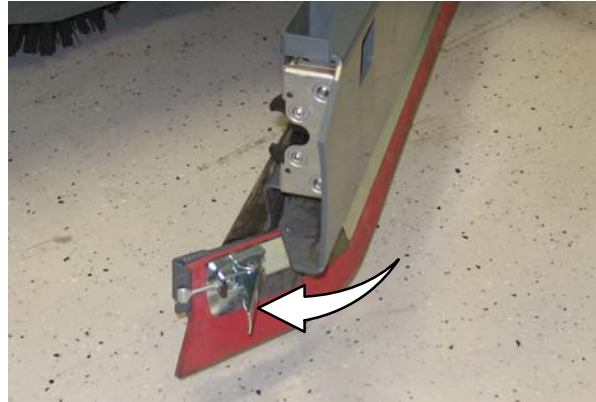

9. Close the outer brush door.

### REPLACING THE SIDE BRUSH SQUEEGEE BLADE (S/N 000000-001278) (OPTION)

Check the side brush squeegee blade for damage and wear daily. Replace the blade if the leading edge is torn or worn half-way through the thickness of the blade.

1. If necessary, raise the scrub head.

**FOR SAFETY: Before leaving or servicing machine, stop on level surface, set parking brake, turn off machine and remove key.**

2. Pull the pin from the squeegee bumper and open the squeegee bumper.



3. Remove the clevis pin and squeegee retainer.



4. Pull the squeegee out from the side brush assembly.



5. Slide the new squeegee into the side brush assembly.
6. Reinstall the squeegee retainer and clevis pin.
7. Close the squeegee bumper and reinsert the pin.

## MAINTENANCE

### REPLACING OR ADJUSTING THE SIDE BRUSH SQUEEGEE BLADE (S/N 001279- ) (OPTION)

**FOR SAFETY: Before leaving or servicing machine, stop on level surface, set parking brake, turn off machine, and remove key.**

Check the side brush squeegee blade for damage and wear daily. Replace the blade if the leading edge is torn or worn half-way through the thickness of the blade.

1. Lower the scrub head.
2. Pull the pins and remove the squeegee bumper.

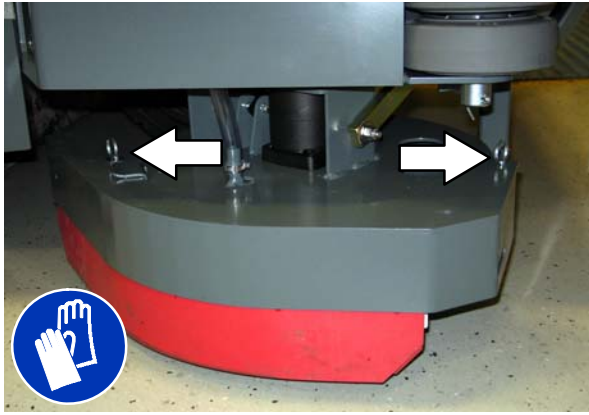

3. Open the retaining band tension latch.

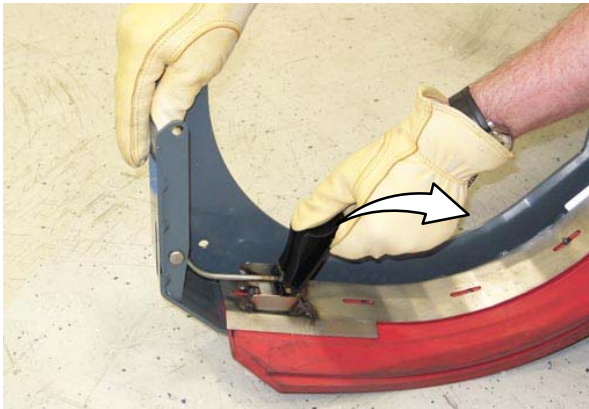

4. Remove the squeegees, spacer, and retainer from the squeegee bumper.

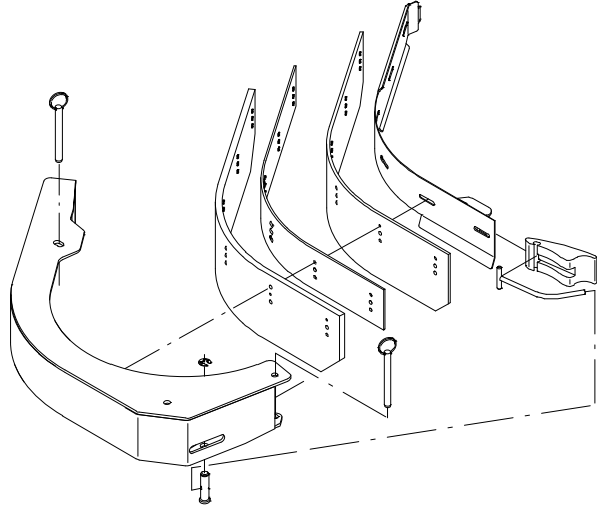

*NOTE: The side brush squeegee blades have different holes for changing height adjustment.*

5. Reinstall the squeegees, spacer, and retainer to the squeegee bumper by aligning the appropriate holes to the pins on the bumper.

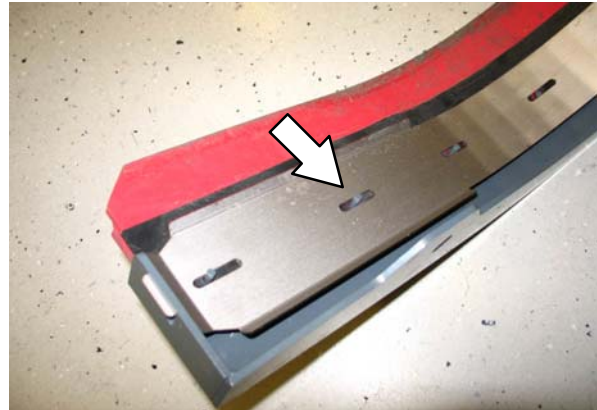

6. Reinstall the retaining band tension latch.
7. Reinstall the squeegee bumper and reinsert the pins.



**LEVELING THE REAR SQUEEGEE**

Leveling the squeegee assures the entire length of the squeegee blade is in even contact with the surface being scrubbed. Perform this adjustment on an even and level floor.

1. Lower the squeegee and drive the machine forward a few meters (feet).

**FOR SAFETY: Before leaving or servicing machine, stop on level surface, set parking brake, turn off machine, and remove key.**

2. Look at the deflection of the squeegee over the full length of the squeegee blade.
3. If the deflection is not the same over the full length of the blade, turn the squeegee levelling nut to make adjustments.

***DO NOT*** disconnect the suction hose from the squeegee frame when leveling squeegee.

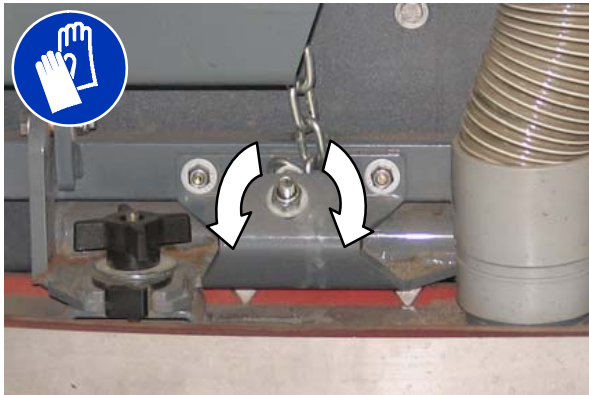

4. Turn the squeegee leveling nut counter-clockwise to decrease the deflection at the ends of the squeegee blade.

Turn the squeegee leveling nut clockwise to increase the deflection at the ends of the squeegee blade.

5. Drive the machine forward with the squeegee down to recheck the squeegee blade deflection if adjustments were made.
6. Readjust the squeegee blade deflection if necessary.

## MAINTENANCE

### ADJUSTING THE REAR SQUEEGEE BLADE DEFLECTION

Deflection is the amount of curl the overall squeegee blade has when the machine moves forward. The best deflection is when the squeegee wipes the floor dry with a minimal amount of deflection.

*NOTE: Make sure the squeegee is level before adjusting the deflection. See LEVELING THE REAR SQUEEGEE.*

1. Lower the squeegee and drive the machine forward a few meters (feet).

**FOR SAFETY: Before leaving or servicing machine, stop on level surface, set parking brake, turn off machine, and remove key.**

2. Look at the amount of deflection or “curl” of the squeegee blade. The correct amount of deflection is 12 mm (0.50 in) for scrubbing smooth floors and 15 mm (0.62 in) for rough floors.

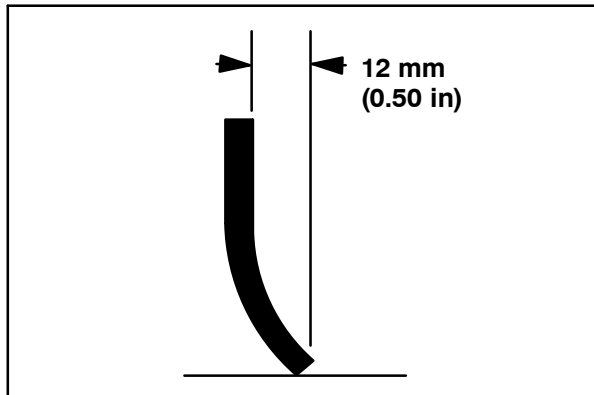

3. To adjust the overall squeegee blade deflection, turn the adjustment knobs counterclockwise to increase deflection or clockwise to decrease deflection.

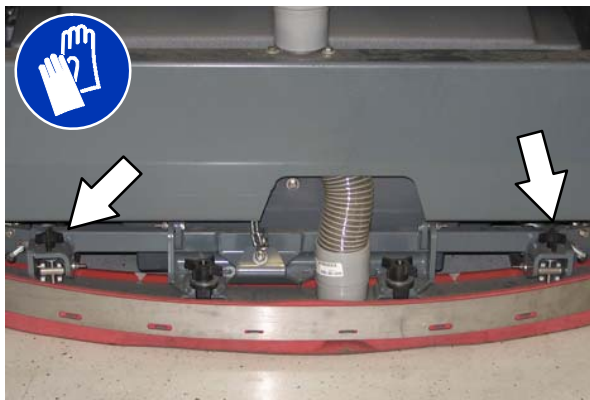

4. Drive the machine forward again to recheck the squeegee blade deflection after adjustments are made.
5. Readjust the squeegee blade deflection if necessary.

---

**SKIRTS AND SEALS**

---

**FOR SAFETY:** Before leaving or servicing machine, stop on level surface, set parking brake, turn off machine, and remove key.

**SCRUB HEAD SKIRT**

Check the skirt for damage and wear after every 100 hours of operation.



The skirts should be between 0 to 6 mm (0 to 0.25 in) from the floor when the scrub head is down.

**RECOVERY TANK SEAL**

Check the recovery tank cover seal for damage and wear daily.

**SOLUTION TANK SEALS**

Check each solution tank cover seal for damage and wear daily.



# MAINTENANCE

## BRAKES AND TIRES

### BRAKES

The mechanical brakes are located on the rear wheels. The brakes are operated by the foot brake pedal and connecting cables.

Check the brake adjustment after every 200 hours of operation.

To check the brake adjustment, measure the distance from the stationary brake pedal to the point where there is resistance in the pedal movement. The distance must be between 6 mm (0.25 in) and 19 mm (0.75 in). Adjust the brakes if required.

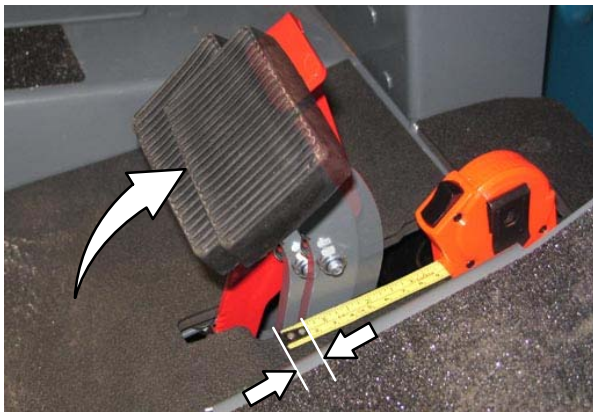

### TIRES

Check tires for damage and wear after every 100 hours of operation.

### FRONT WHEEL

Torque the front wheel nuts twice in the pattern shown to 122 to 149 Nm (90 to 110 ft lb) after the first 50 hours of operation, and after every 800 hours there after.

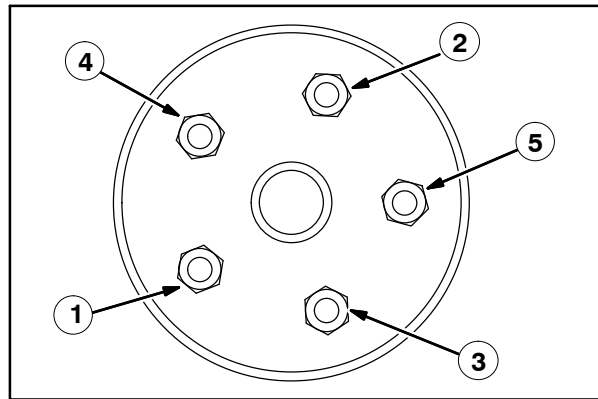

### PROPELLING MOTOR

Torque the shaft nut to 508 Nm (375 ft lb) lubricated, 644 Nm (475 ft lb) dry, after every 800 hours of operation.





**PUSHING, TOWING, AND TRANSPORTING THE MACHINE**

**PUSHING OR TOWING THE MACHINE**

If the machine becomes disabled, it can be pushed from the front or rear, but only towed from the front.

The propelling pump has a bypass valve to prevent damage to the hydraulic system when the machine is being pushed or towed. This valve allows a disabled machine to be moved for a *very short distance* and at a speed to not exceed 1.6 kp/h (1 mph). The machine is NOT intended to be pushed or towed a long distance or at a high speed.

**ATTENTION! Do not push or tow machine for a long distance or damage may occur to the propelling system.**

Turn the bypass valve located on the bottom of the propelling pump 90° (either direction) from the normal position before pushing or towing the machine. Return the bypass valve back to the normal position when through pushing or towing the machine. **Do Not** use the bypass valve during normal machine operation.

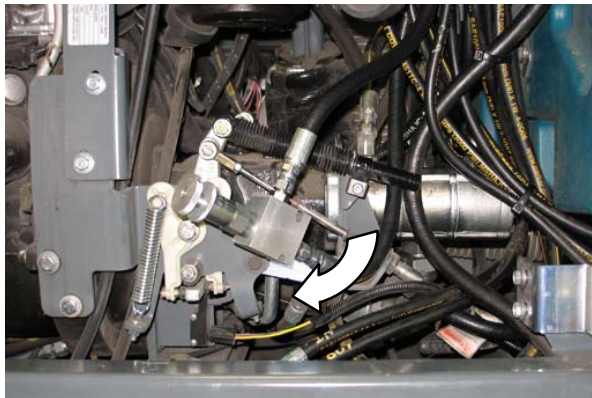
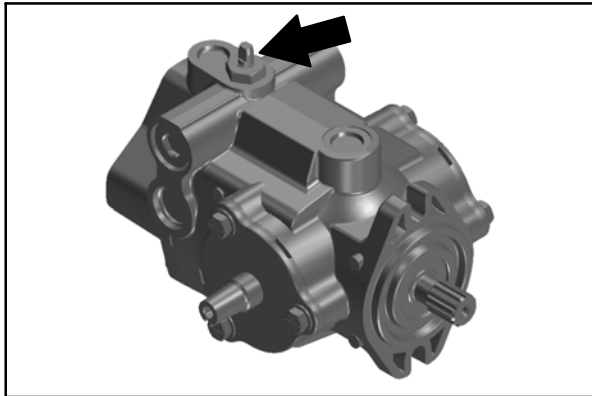

**TRANSPORTING THE MACHINE**

1. Raise the squeegee, scrub head, and brushes. If necessary, raise the hopper for additional ramp clearance.

**FOR SAFETY: When loading machine onto truck or trailer, drain tanks and empty hopper before loading machine.**

2. Position the rear of the machine at the loading edge of the truck or trailer.
3. If the loading surface is not horizontal or is higher than 380 mm (15 in) from the ground, use a winch to load machine.

If the loading surface is horizontal and 380 mm (15 in) or less from the ground, the machine may be driven onto the truck or trailer.

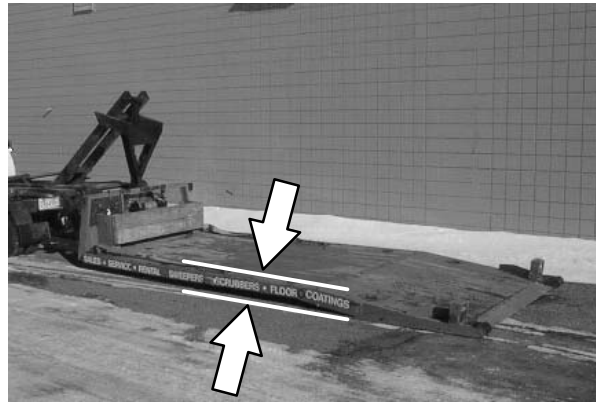

**FOR SAFETY: When loading machine onto truck or trailer, use winch. Do not drive the machine onto the truck or trailer unless the loading surface is horizontal AND is 380 mm (15 in) or less from the ground.**

4. To winch the machine onto the truck or trailer, attach the winching chains to the holes in the rear jacking brackets behind the rear tires.

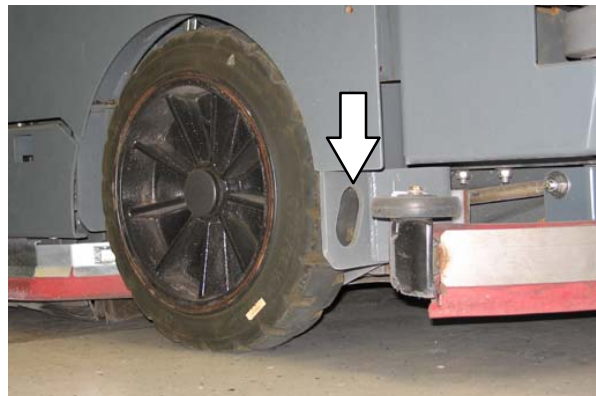

## MAINTENANCE

5. Position the machine as close to the front of the trailer or truck as possible.
6. Set the parking brake and place a block behind each wheel to prevent the machine from rolling.
7. Lower the scrub head.

**FOR SAFETY: When loading/unloading machine onto/off truck or trailer, lower scrub head and squeegee before tying down machine.**

8. Connect the tie-down straps to the holes in the right and left lower corners in front of the machine and the holes in the rear jacking brackets behind the rear tires.

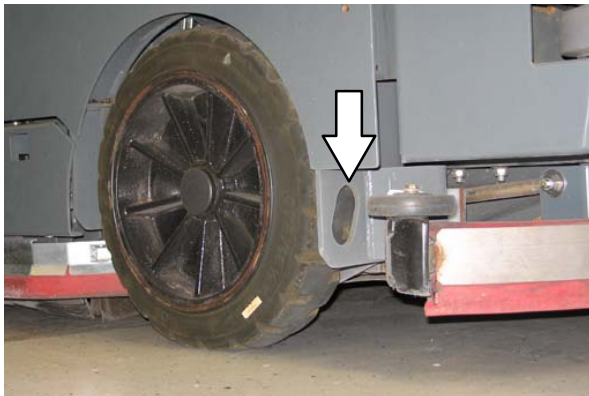
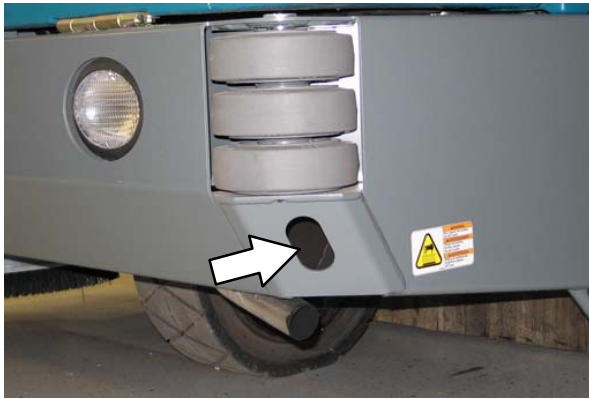

9. Route the tie-downs to the opposite ends of the machine and hook them to the brackets on the floor of the trailer or truck. Tighten the tie-down straps.

*NOTE: It may be necessary to install tie-down brackets to the floor of the trailer or truck.*

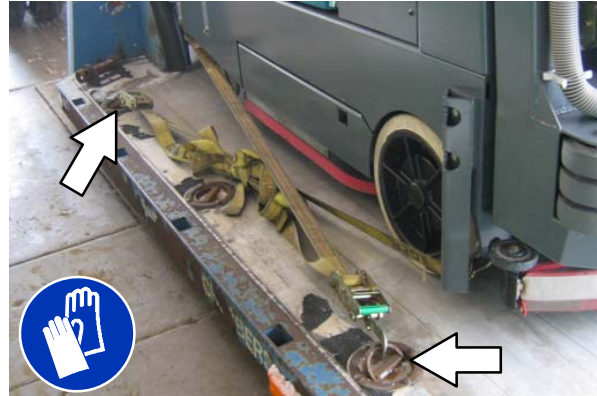

10. If the loading surface is not horizontal or is higher than 380 mm (15 in) from the ground, use a winch to unload machine.

If the loading surface is horizontal AND is 380 mm (15 in) or less from the ground, the machine may be driven off the truck or trailer.

**FOR SAFETY: When unloading machine off truck or trailer, use winch. Do not drive the machine off the truck or trailer unless the loading surface is horizontal AND 380 mm (15 in) or less from the ground.**

**MACHINE JACKING**

Empty the hopper, recovery tank, and solution tank before jacking up the machine. Jack up the machine at the designated locations. Use a hoist or jack capable of supporting the weight of the machine. Use jackstands to support the machine. Always stop the machine on a flat, level surface and block the tires before jacking up the machine.

Rear jacking locations are located directly behind the rear tires on each side of the machine.

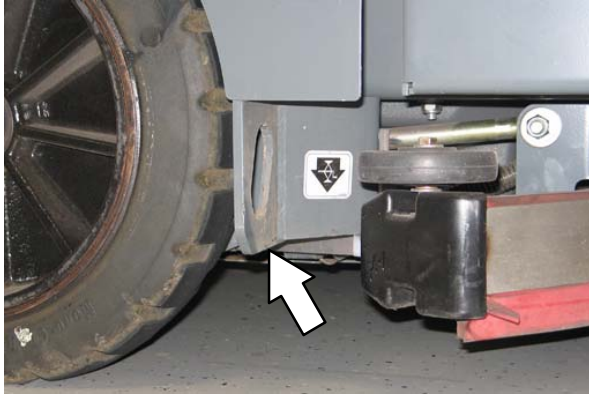

Front jacking locations are located on the frame directly in front of the front tire.

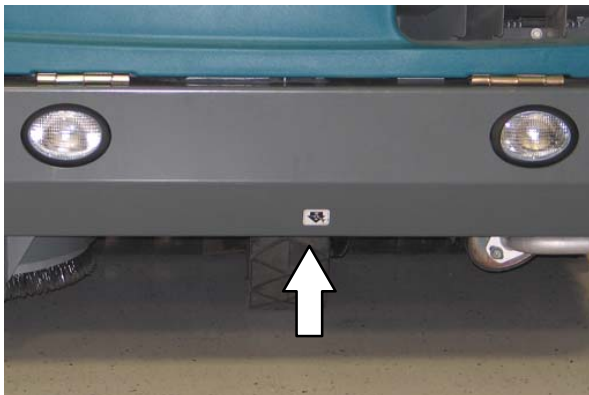

**FOR SAFETY: Before leaving or servicing machine, stop on level surface, set parking brake, turn off machine, and remove key.**

**FOR SAFETY: When servicing machine, block machine tires before jacking machine up. Use a hoist or jack that will support the weight of the machine. Jack machine up at designated locations only. Support machine with jack stands.**

**STORAGE INFORMATION**

The following steps should be taken prior to storing the machine for extended periods.

1. Drain and clean the solution and recovery tanks. Open the recovery tank and solution tank covers to allow the air to circulate.
2. Park the machine in a cool, dry area. Do not expose the machine to rain. Store indoors.
3. Remove the battery, or charge battery every three months.

## MAINTENANCE

### FREEZE PROTECTION (MACHINES WITHOUT ec-H<sub>2</sub>O SYSTEM)

**FOR SAFETY:** Before leaving or servicing machine, stop on level surface, set parking brake, and turn off machine.

1. Be sure the solution tank and recovery tank are empty.
2. Pour 3.8 L (1 gal) of Propylene Glycol Based / Recreational Vehicle (RV) Antifreeze into the solution tank.
3. Turn the key to the on position (**without starting the machine**).
4. Press the *1-STEP Scrub button*.
5. Repeatedly press the *Solution increase button (+)* until the solution flow is at the highest setting.
6. Press the *directional pedal* to circulate the RV antifreeze completely through the system.
7. Press the *1-STEP Scrub button* to turn off the system.
8. **Machines equipped with the optional spray nozzle only:** Turn on the pump until RV antifreeze solution sprays from the nozzle.
9. Turn the key to the off position.
10. The remaining RV antifreeze does not need to be drained from the solution tank.

*NOTE: Storing or transporting machines equipped with the ES or the FaST system in freezing temperatures requires special procedures. Consult a TENNANT representative for more information.*

### FREEZE PROTECTION (MACHINES WITH ec-H<sub>2</sub>O SYSTEM)

**FOR SAFETY:** Before leaving or servicing machine, stop on level surface, set parking brake, and turn off machine.

1. Empty the solution tank and recovery tank.
2. Remove the intake flush hose and from the storage bag behind the operator seat.
3. Disconnect the *ec-H<sub>2</sub>O* system intake hose from the solution supply hose and connect the intake flush hose (gray connector) to the *ec-H<sub>2</sub>O* system intake hose.



4. Pull the drain tube from the between the ec-H<sub>2</sub>O unit and the operator compartment, remove the cap from the tube, and place the end of the tube into an empty container. Set the cap aside.





5. Turn the key to the on position (**without starting the machine**).
6. Press and release the *ec-H2O* module flush switch. Allow the system to drain water into the container for 2 minutes.

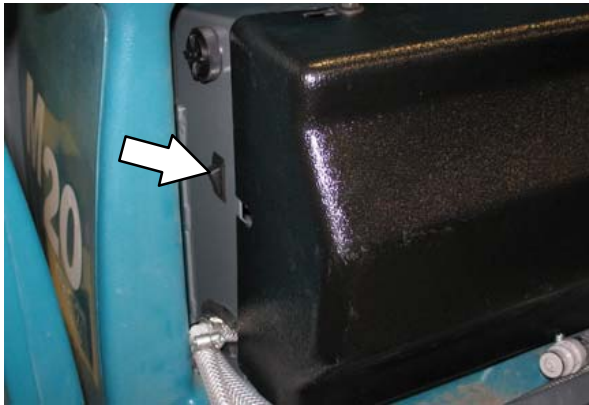

7. Press the *ec-H2O* module flush switch to shut off the system.
8. Disconnect the *ec-H2O* system outlet hose from the hose to the scrub head.



9. Blow pressurized air (less than 344 kPa (50 psi)) into the *ec-H2O* system outlet hose. Continue blowing compressed air into the outlet hose until water no longer drains from the drain tube.



10. Reinstall the cap onto the drain tube and insert the tube back between the *ec-H2O* module and the operator compartment.
11. Reconnect the *ec-H2O* system intake hose to the solution supply hose and the *ec-H2O* system outlet hose to the hose to the scrub head.
12. Return the intake flush hose to the storage bag behind the operator seat.

### PRIMING THE *ec-H2O* SYSTEM

Prime the *ec-H2O* system if the machine has been stored for a long period without water in the solution tank / *ec-H2O* system.

**FOR SAFETY: Before leaving or servicing machine, stop on level surface, set parking brake, and turn off machine.**

1. Fill the solution tank with clean cool water.  
See *FILLING THE SOLUTION TANK* section of this manual.
2. Remove the outlet flush hose (black connector) from the storage bag behind the operator seat.
3. Disconnect the *ec-H2O* system outlet hose from the hose to the scrub head and connect the outlet flush hose to the *ec-H2O* system outlet hose.



4. Place the *ec-H2O* system outlet hose into an empty container.
5. Turn the key to the on position (**without starting the machine**).
6. Press and release the *ec-H2O* module flush switch. Allow the system to drain water into the container for 2 minutes.
7. Press the *ec-H2O* module flush switch to shut off the system.
8. Disconnect the outlet flush hose from the *ec-H2O* system outlet hose and return the flush hose to the storage bag.
9. Reconnect the *ec-H2O* system outlet hose to the hose to the scrub head.

**SPECIFICATIONS**

**GENERAL MACHINE DIMENSIONS/CAPACITIES**

Item	Dimension/Capacity
Length	2745 mm (108 in)
Height	1475 mm (58 in)
Height (with overhead guard)	2135 mm (84 in)
Width/frame (roller to roller)	1475 mm (58 in)
Width (rear squeegee)	1500 mm (59 in)
Width (with side brush)	1625 mm (64 in)
Cleaning path width (Main brush length)	1220 mm (48 in)
Cleaning path width (with scrubbing side brush)	1575 mm (62 in)
Cleaning path width (with sweeping side brush)	1625 mm (64 in)
Main brush diameter (2)	305 mm (12 in)
Side brush diameter (scrubbing)	410 mm (16 in)
Side brush diameter (sweeping)	535 mm (21 in)
Solution tank capacity	284 L (75 gallons)
Recovery tank capacity	360 L (95 gallons)
Debris hopper volume capacity	198 L (7.0 ft <sup>3</sup> )
Debris hopper weight capacity	295 kg (650 lbs)
Dump height (variable to)	1525 mm (60 in)
Minimum ceiling dump height	2620 mm (103 in)
Weight – empty	1815 Kg (4000 lbs)
GVWR	2449 Kg (5400 lbs)
Transport ground clearance	80 mm (3 in)
Protection Grade	IPX3

Values determined as per IEC 60335-2-72	Measure
Sound pressure level $L_{pA}$	84 dB(A)
Sound uncertainty $K_{pA}$	3.0 dB(A)
Sound power level $L_{WA}$ + Uncertainty $K_{WA}$	106 dB(A)
Vibration – Hand–arm	< 2.5 m/s <sup>2</sup>
Vibration – Whole body	< 0.5 m/s <sup>2</sup>

**GENERAL MACHINE PERFORMANCE**

Item	Measure
Minimum aisle turn	3175 mm (125 in)
Travel speed forward (maximum)	12.9 Km/h (8 mph)
Travel speed reverse (maximum)	4.8 Km/h (3 mph)
Maximum ramp incline for loading – Empty tanks	18%
Maximum ramp incline for scrubbing	10%
Maximum ramp incline for transporting (GVWR)	14%
Maximum ambient temperature for machine operation	43° C (110° F)
Minimum temperature for operating machine scrubbing functions	0° C (32° F)

**HYDRAULIC SYSTEM**

System	Capacity	ISO Grade Viscosity Index	Ambient Air Temperature Ranges
Hydraulic reservoir	38 L (10 gal)	ISO 100 VI 126 or higher	19° C (65° F) or higher
Hydraulic total	45 L (12 gal)	ISO 68 VI 155 or higher	7 to 43° C (45 to 110° F)
		ISO 32 VI 163 or higher	16° C (60° F) or lower

# SPECIFICATIONS

## POWER TYPE

Engine	Type	Ignition	Cycle	Aspiration	Cylinders	Bore	Stroke
GM 1.6 (S/N 000000 – 003999)	Piston	Distributorless-type spark	4	Natural	4	79 mm (3.11 in)	81.5 mm (3.21 in)
	Displacement		Tennant machine governed net power			Engine mfg un-governed net power	
	1600 cc (98 cu in)		23.2 kw (32 hp) @ 2400 rpm			39.5 kw (53 hp) @ 4000 rpm	
	Fuel		Cooling system			Electrical system	
	Gasoline, 87 octane minimum, unleaded Fuel tank: 42 L (11.2 gal)		Water/ethylene glycol antifreeze			12 V nominal	
	LPG, Fuel tank: 15 kg (33 lb)		Total: 7.5 L (2 gal) Radiator: 3.8 L (1 gal)			75 A alternator	
	Idle speed, no load		(Fast) governed speed, under load			Firing order	
	950 ± 50 rpm (machines serial number 001999 and below)  1350 ± 50 rpm (machines serial number 002000 and above)		2400 ± 50 rpm			1-3-4-2	
	Spark plug gap		Valve clearance, cold			Engine lubricating oil with filter	
	1 mm (0.035 in)		No Adjustment OHC Engine			3.5 L (3.7 qt) 5W30 SAE-SG/SH	

Engine	Type	Ignition	Cycle	Aspiration	Cylinders	Bore	Stroke
Mitsubishi 2.0 (S/N 004000 – )	Piston	Coil @ Plug	4	Natural	4	85 mm (3.35 in)	88 mm (3.46 in)
	Displacement		Tennant machine governed net power			Engine mfg un-governed net power	
	1997 cc (122 cu in)		37.3 kw (50 hp) @ 2300 rpm			44.7 kw (60 hp) @ 3000 rpm	
	Fuel		Cooling system			Electrical system	
	Gasoline, 87 octane minimum, unleaded Fuel tank: 42 L (11.2 gal)		Water/ethylene glycol antifreeze			12 V nominal	
	LPG, Fuel tank: 15 kg (33 lb)		Total: 7.5 L (2 gal) Radiator: 3.8 L (1 gal)			75 A alternator	
	Idle speed, no load		(Fast) governed speed, under load			Firing order	
	1350 ± 50 rpm		2300 ± 50 rpm			1-3-4-2	
	Spark plug gap		Valve clearance, cold			Engine lubricating oil with filter	
	1.1 mm (0.043 in)		No Adjustment OHC Engine			4.7 L (5 qt) 5W30 SAE-SG/SH	



**BRAKING SYSTEM**

Type	Operation
Service brakes	Mechanical drum brakes (2), one per rear wheel, cable actuated
Parking brake	Utilize service brakes, cable actuated

**TIRES**

Location	Type	Size
Front (1)	Solid	150 mm x 460 mm (6 in x 18 in)
Rear (2)	Solid	127 mm x 460 mm (5 in x 18 in)

**STEERING**

Type	Power source
Front wheel, hydraulic cylinder and rotary valve controlled	Hydraulic accessory pump

## SPECIFICATIONS

### FaST SYSTEM

Item	Measure
Solution pump	12 Volt DC, 11A, 0.7 GPM & 1.4 GPM flow (2 speed), 75 psi high-pressure shutdown
Low solution flow rate	2.7 LPM (0.7 GPM)
High solution flow rate	5.4 LPM (1.4 GPM)
Low concentrate flow rate	2.6 CC/Minute (0.085 Liquid Ounces/Minute)
High concentrate flow rate	5.2 CC/Minute (0.17 Liquid Ounces/Minute)

### ec-H2O SYSTEM

Item	Measure
Solution pump	12 Volt DC, 11A, 0.7 GPM & 1.4 GPM flow, (2 speeds), 75 psi high-pressure shutdown
Solution flow rate	2.65 LPM (0.7 GPM) – Low
	5.30 LPM (1.4 GPM) – High

**MACHINE DIMENSIONS**

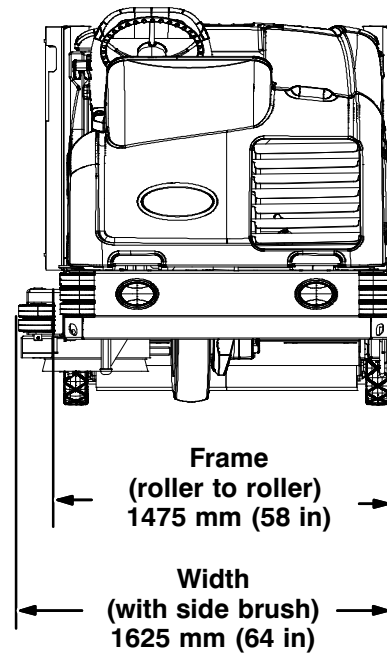
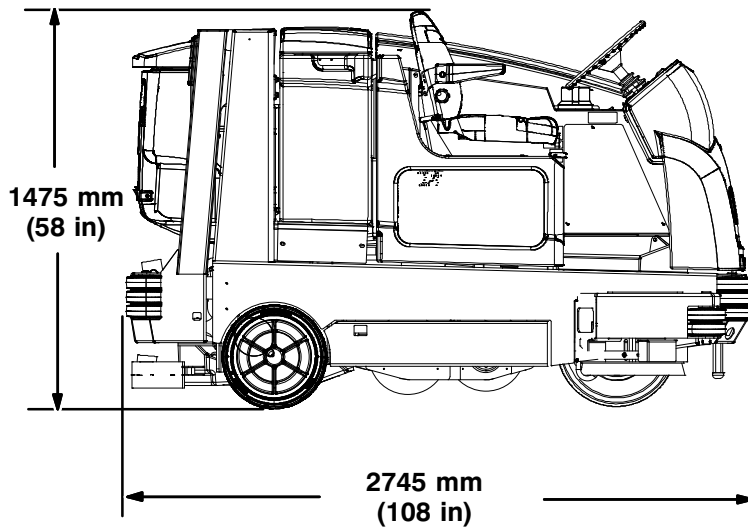
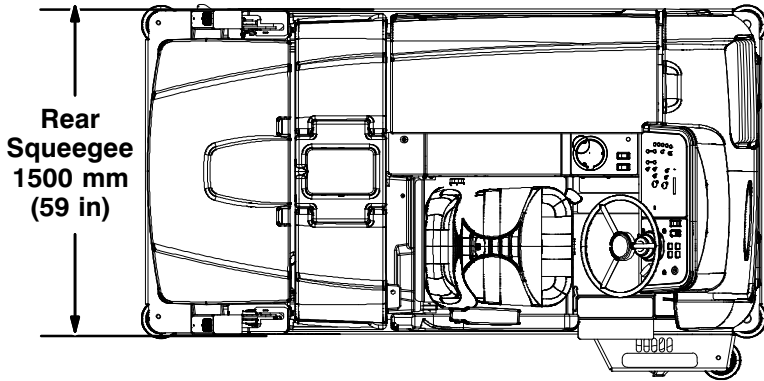

1014751

**Numbers**

- 1–STEP Scrub button, 12, 16, 23, 24, 25, 26, 27
- 1–STEP Sweep button, 12, 16, 24, 28

**A**

- Adjust operator seat, 14
- Adjust steering column, 15
- Adjusting the Main Brush Taper, 64
- Adjusting the Main Brush Width, 64
- Adjusting the Rear Squeegee Blade Deflection, 76
- Air Filter, 55
- Alarms, 39
  - Fault Indicators, 39

**B**

- Battery, 58
- Belts, Camshaft and Balance, 58
- Brake pedal, 15
- Brakes, 78
  - System specifications, 87
- Brakes and Tires, 78
  - Brakes, 78
  - Front Wheel, 78
  - Tires, 78
- Brush Information, 17
- Buttons
  - 1–STEP Scrub button, 25
  - 1–STEP Sweep button, 28
  - Brush Pressure decrease button (-), 24
  - Brush Pressure increase button (+), 24
  - ec–H2O button, 23
  - Engine Speed Button, 12
  - ES (Extended Scrub) button, 23
  - FaST button, 23
  - Filter shaker button, 29
  - Hopper door open/close button, 29
  - Hopper raise/lower button, 29
  - Scrub vacuum fan/squeegee button, 26
  - Side Brush button (Option), 12
  - Solution decrease button (-), 24
  - Solution increase button (+), 24
  - Supervisor Control Buttons, 13
  - Sweep vacuum fan button, 28
- Buttons, Controls and Instruments, 9, 12
- Bypass valve, 79

**C**

- Camshaft and Balance Shaft Belts, 58
- Capacities, 85
- Changing the LPG Tank, 19
- Charging System Indicator, 11
- Check Engine Indicator, 11
- Checking the Main Brush Pattern, 63
- Cleaning the ec–H2O filter screen, 68
- Cleaning the FaST Supply Hose Connector, 66
- Cleaning the FaST System Check Valves, 67
- Cleaning the FaST System Filter Screen, 66
- Cleaning the Hopper and Debris Screen, 32
- Cleaning the Hopper Dust Filter, 60
- Conditions / Warnings, 40
- Contents, 1
- Controls and Instruments, 8, 9
  - Touch Panel, 9
- Cooling System, 55

**D**

- Dimensions, 85
- Directional pedal, 15
- Disengaging Hopper Support Pin, 30
- Double Scrubbing, 26
- Draining and Cleaning the Recovery Tank, 34
  - Draining the Recovery Tank with the Drain Hose, 34
  - Draining the Recovery Tank with the Drain Plug, 35
- Draining and Cleaning the Solution Tank, 37
- Draining the Recovery Tank with the Drain Hose, 34
- Draining the Recovery Tank with the Drain Plug, 35
- Dust Filter, 31
  - Removing the Hopper Dust Filter, 31
  - Replacing the Hopper Dust Filter, 31



**E**

ec–H2O module flush switch, 68  
 ec–H2O Scrubbing System, Indicator Light Codes, 25  
 ec–H2O Scrubbing System Indicator Light Codes , 25  
 ec–H2O system indicator light, 25  
 Electronic Pressure Regulator, 56  
 Emptying the Hopper, 29  
 Engaging Hopper Support Pin, 30  
 Engine, 55  
   Air Filter, 55  
   Camshaft and Balance Shaft Belts, 58  
   Cooling System, 55  
   Electronic Pressure Regulator, 56  
   Engine Belt, 57  
   Fuel Filter, 56  
   LPG Vaporizer, 56  
   PCV System, 57  
   Spark Plugs, 57  
   Specifications, 86  
   Timing Belt, 58  
 Engine Belt, 57  
 Engine Harness Fuses and Relays, 59  
 Engine Oil, 51  
 Engine Oil Pressure Indicator, 11  
 Engine Speed Button, 12

**F**

FaST System, 66, 67  
   Cleaning the FaST Supply Hose Connector, 66  
   Cleaning the FaST System Check Valves, 67  
   Cleaning the FaST System Filter Screen, 66  
   Replacing the FaST–PAK Carton, 66  
 Fault Indicators, 39  
 Filling the Solution Tank, 21  
   Conventional Scrubbing Mode, 21  
   ec–H2O scrubbing (ec–H2O Mode), 21  
   ES (Extended Scrub) Mode – Manually Filling Tanks, 22  
   ES (Extended Scrub) Mode with Auto–Fill, 22  
   Foam scrubbing (FaST Mode), 21

Filters, 31  
   Cleaning the Hopper Dust Filter, 60  
   Engine Air Filter, 55  
   Gasoline Fuel Filter, 56  
   Hydraulic Fluid Filter, 53  
   LPG Fuel Filter, 56  
   Removing the Hopper Dust Filter, 31  
   Replacing the Hopper Dust Filter, 31  
 Freeze Protection (Machines with ec–H2O system), 82  
 Freeze Protection (Machines without ec–H2O system), 82  
 Front Wheel Support Bearing, 51  
 Front Wheel, Torque, 78  
 Fuel Filter  
   Gasoline, 56  
   LPG, 56  
 Fuel Indicator, 12  
 Fuses and Relays, 58  
   Engine Harness Fuses and Relays, 59  
   Optional, 59  
   Relay Panel Fuses and Relays, 58, 59

**H**

Hazard Light Switch (Option), 13  
 Headlights, 13  
 High Pressure Washer (Option), 43  
 Hopper Door Pivots, 52  
 Hopper Lift Arm Pivots, 52  
 Hopper Support Pin, 30  
   Disengaging Hopper Support Pin, 30  
   Engaging Hopper Support Pin, 30  
 Hour Meter, 13  
 How the Machine Works, 16  
 Hydraulic Fluid, 54  
 Hydraulic Hoses, 54  
 Hydraulic System, System specifications, 86  
 Hydraulics, 53  
   Drain and refill hydraulic fluid reservoir, 53  
   Hydraulic Fluid, 54  
   Hydraulic Hoses, 54  
   Replace the filler cap, 53  
   Replace the hydraulic fluid filter, 53

**I**

Incline, Rated, 17  
Indicator Light Codes, ec—H2O Scrubbing System, 25  
Indicator light, ec—H2O system, 25  
Indicators  
  Charging System Indicator, 11  
  Check Engine Indicator, 11  
  Conditions / Warnings, 40  
  Engine Oil Pressure Indicator, 11  
  Fault Indicators, 39  
  Fuel Indicator, 12  
  Hour Meter, 13

**L**

Leveling the Rear Squeegee, 75  
Lights  
  Hazard Light Switch (Option), 13  
  Headlights, 13  
  Operating, 13  
LPG Vaporizer, 56  
Lubrication, 51  
  Engine Oil, 51  
  Front Wheel Support Bearing, 51  
  Hopper Door Pivots, 52  
  Hopper Lift Arm Pivots, 52  
  Rear wheel bearings, 51  
  Squeegee Caster Bearings, 51  
  Steering Cylinder Bearing, 51  
  Torque Tubes, 52

**M**

Machine components, 7  
Machine Dimensions, 89  
Machine Jacking, 81  
Machine Operation, Pre—Operation Checklist, 18  
Machine Performance  
  Aisle Turnaround Width, 85  
  Climb and Descent Angles, 85  
  Travel Speed (Maximum), 85  
Machine Specifications, 85 – 88  
Machine Troubleshooting, 45  
Main Brushes, 61  
  Adjusting the Taper, 64  
  Adjusting the Width, 64  
  Checking the Main Brush Pattern, 63  
  Replacing or Rotating the Main Brushes, 61  
Main Brushes, Adjusting the Taper, 64  
Main Brushes, Adjusting the Width, 64  
Main Brushes, Checking the Pattern, 63  
Main Brushes, Replacing or Rotating, 61  
Maintenance, 47 – 71  
Maintenance Chart, 48

**O**

Operating Lights, 13  
Operating temperature, 17  
Operation, 7 – 31  
Operation of controls, 11  
Operator seat, 14  
Optional Relays, 59  
Options, 41  
  Hazard Light, 13  
  High Pressure Washer, 43  
  Side Brush, 12  
  Spray Nozzle, 41  
  Squeegee protectors, 15  
  Vacuum Wand, 42

**P**

Parking brake pedal, 15  
 PCV System, 57  
 Pedals  
   Brake pedal, 15  
   Directional pedal, 15  
   Parking brake pedal, 15  
 Pre—Operation Checklist, 18  
 Priming the ec—H2O system, 84  
 Propelling Motor, 78  
   Torque Shaft Nut, 78  
 Pushing or Towing the Machine, 79  
 Pushing, Towing, and Transporting the Machine, 79  
   Pushing or Towing the Machine, 79  
   Transporting the Machine, 79

**R**

Radiator, 55  
   Check hoses and clamps, 55  
   Clean core exterior, 55  
 Rated incline, 17  
 Rear Squeegee  
   Adjusting the Rear Squeegee Blade Deflection, 76  
   Leveling the Rear Squeegee, 75  
 Rear Squeegee Blade, Replacing (or Rotating) the Rear Squeegee Blade, 69  
 Rear Squeegee, Replacing (or Rotating), 69  
 Rear Wheel bearings, 51  
 Recovery Tank Seal, 77  
 Relay Panel Fuses and Relays, 58, 59  
 Removing the Hopper Dust Filter, 31  
 Replacing (or Rotating) the Rear Squeegee Blades, 69  
 Replacing or Adjusting the Side Brush Squeegee Blade (S/N 003077— ) (Option), 74  
 Replacing or Rotating the Main Brushes, 61  
 Replacing or Rotating the Side Squeegee Blades, 71  
 Replacing the FaST—PAK Carton, 66  
 Replacing the Hopper Dust Filter, 31  
 Replacing the Side Brush (Option), 65  
 Replacing the Side Brush Squeegee Blade (S/N 000000—003076) (Option), 73

**S**

Safety  
   Instructions, 3 – 5  
   Labels, 5 – 7  
 Scrub Head Skirt, 77  
 Scrubbing, 25  
 Seals, 77  
   Recovery Tank Seal, 77  
   Solution Tank Seals, 77  
 Seat belts, 14  
 Seat, Operator, 14  
 Setting Brush Pressure, 24  
 Setting Conventional Solution Flow, 24  
 Setting ec—H2O Mode, 23  
 Setting ES (Extended Scrub) Mode, 23  
 Setting ES Solution Flow, 24  
 Setting FaST Mode, 23  
 Setting FaST Solution Flow, 24  
 Setting Scrub Modes, 23  
   Setting Brush Pressure, 24  
   Setting ec—H2O Mode, 23  
   Setting ES (Extended Scrub) Mode, 23  
   Setting ES Solution Flow, 24  
   Setting FaST Mode, 23  
   Setting Solution Flow, 24  
     Conventional and FaST Mode, 24  
     ES (Extended Scrub) Mode, 24  
 Setting the Engine Speed, 12  
 Side Brush, 12  
 Side Brush (Option), 65  
   Replacing the Side Brush, 65  
   Replacing the Side Brush Squeegee (S/N 000000—003076), 73  
 Side Brush (S/N 003077— ) (Option), Replacing the Side Brush Squeegee, 74  
 Side Brush Squeegee (S/N 000000—003076) (Option), Replacing, 73  
 Side Brush Squeegee (S/N 003077— ) (Option), Replacing or Adjusting, 74  
 Side Brush, Replacing, 65  
 Side Squeegee Blades, 71  
   Replacing or Rotating the Side Squeegee Blades, 71  
 Side Squeegee, Replacing or Rotating, 71

Skirts and Seals, 77  
  Recovery Tank Seal, 77  
  Scrub Head Skirt, 77  
  Solution Tank Seals, 77  
Solution Tank Seals, 77  
Spark Plugs, 57  
Specifications, 85 – 88  
  Braking system, 87  
  ec-H<sub>2</sub>O system, 88  
  FaST System, 88  
  Hydraulic System, 85  
  Machine Capacities, 85  
  Machine Dimensions, 85  
  Machine Performance, 85  
  Power Type, 86  
  Steering, 87  
  Tires, 87  
Spray Nozzle (Option), 41  
Squeegee Blades, 69  
  Replacing (or Rotating) the Rear Squeegee  
  Blades, 69  
  Replacing or Rotating the Side Squeegee  
  Blades, 71  
Squeegee Caster Bearings, 51  
Squeegee Protectors (Option), 15  
Starting the Machine, 20  
Steering, Specifications, 87  
Steering Cylinder Bearing, 51  
Storage Information, 81  
  Freeze Protection, 82  
  Priming the ec-H<sub>2</sub>O system, 84  
  Storing the Machine, 81  
Supervisor Control Buttons, 13  
Sweeping, 27  
Symbol definitions, 10 – 12

**T**

Temperature, Operating, 17  
Thermo—Sentry, 60  
Timing Belt, 58  
Tires, 78  
  Specifications, 87  
Torque Tubes, 52  
Touch Panel, 9  
Towing the Machine, 79  
Transporting the Machine, 79  
Turning Off the Machine, 20

**V**

Vacuum Wand (Option), 42  
Vaporizer, 56

**W**

Warning Indicators, 11, 39  
  Charging System Indicator, 11  
  Check Engine Indicator, 11  
  Conditions / Warnings, 40  
  Engine Oil Pressure Indicator, 11  
  Fault Indicators, 39  
Water Pickup Mode (No Scrubbing), 27  
Wheels, 78  
While Operating the Machine, 17