

# Scanima A/S Testmixer SRB-100

Power supply.....	1
Main Current.....	2
Power supply.....	3
Emergency stop.....	4
PLC Layout.....	5
PLC Digital Input.....	6
PLC Digital Output.....	7
PLC Digital Output.....	8
PLC Analog Input.....	9
PLC Analog Output.....	10
Mixer start-stop + Stirrer start-stop.....	11
Cable-/terminal list.....	12
Cable-/terminal list.....	13
Cable-/terminal list.....	14
Cable-/terminal list.....	15
Part list.....	16
PLC I/O list.....	18
Declaration of conformity.....	19

1 2 3 4 5 6 7 8 9 10

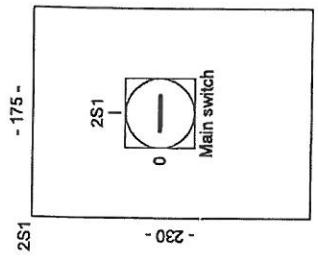

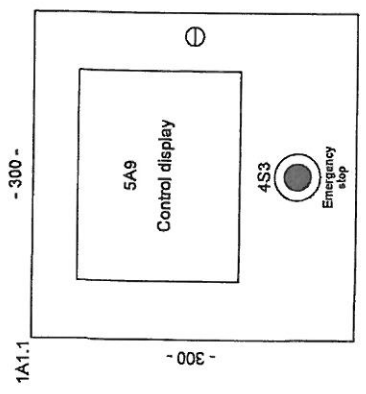
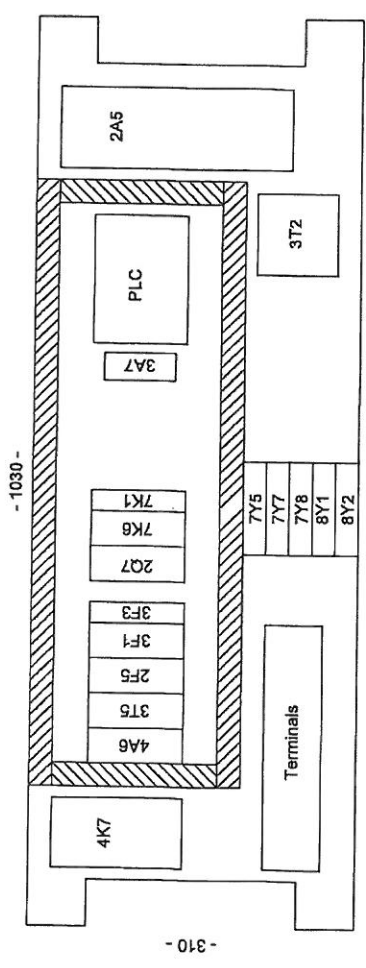
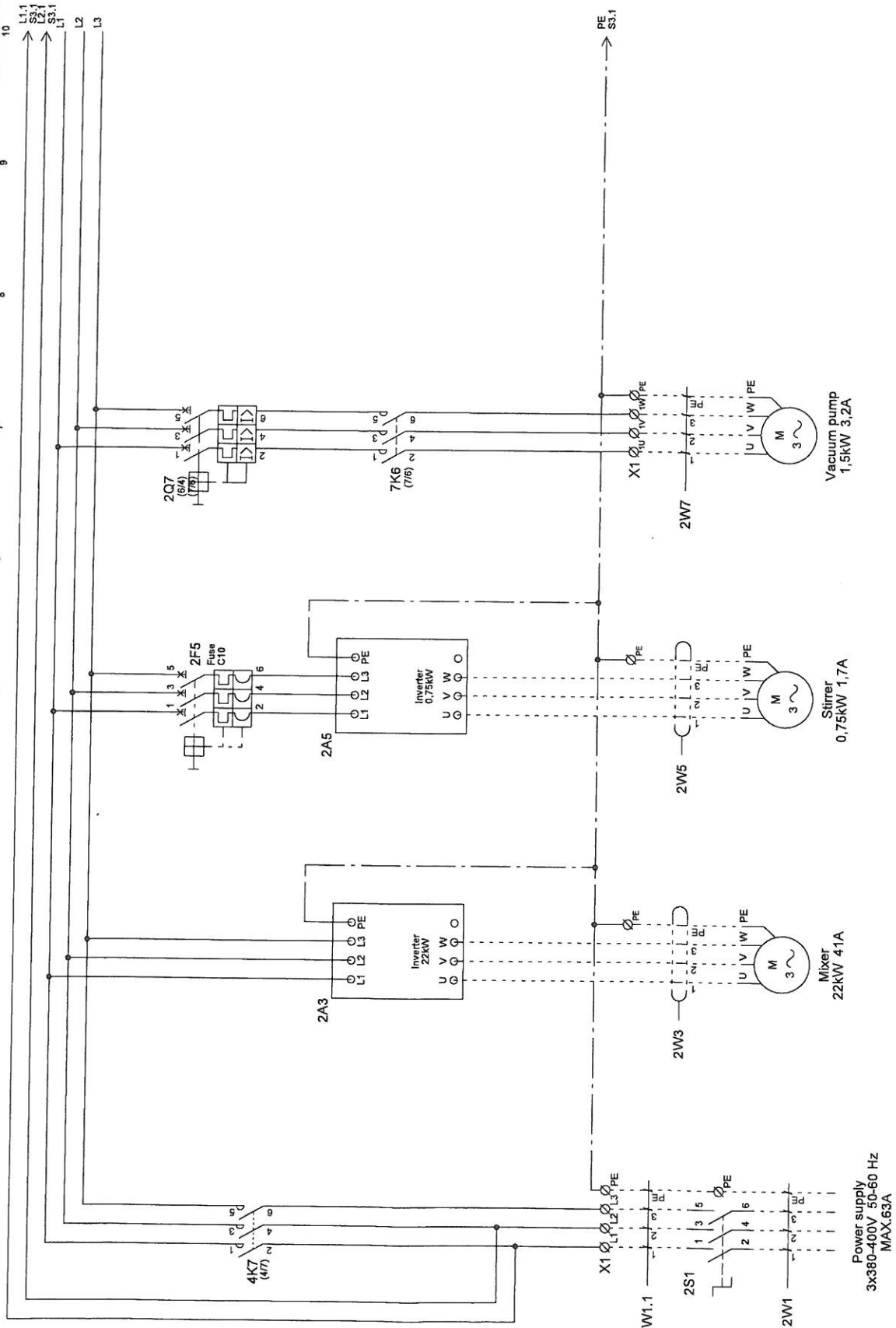

Power supply  
3x380-400V 50-60 Hz  
MAX.63A

**Nordland Automatic**  
Ingeniør-og installørfirma  
Hædsundvej 80 9000 Aalborg  
Tlf. +45 96312020

Customer: Scanima A/S  
Project title: Testmøder SRB-100  
Page title: Main Current  
Scanima no.: 9006

Constr.: Christian P.  
Date: 13-10-05  
Page latest change: 20-06-05

Case No.: D05114  
Order No.: 11346  
Rev.:  
Page 2 of 19

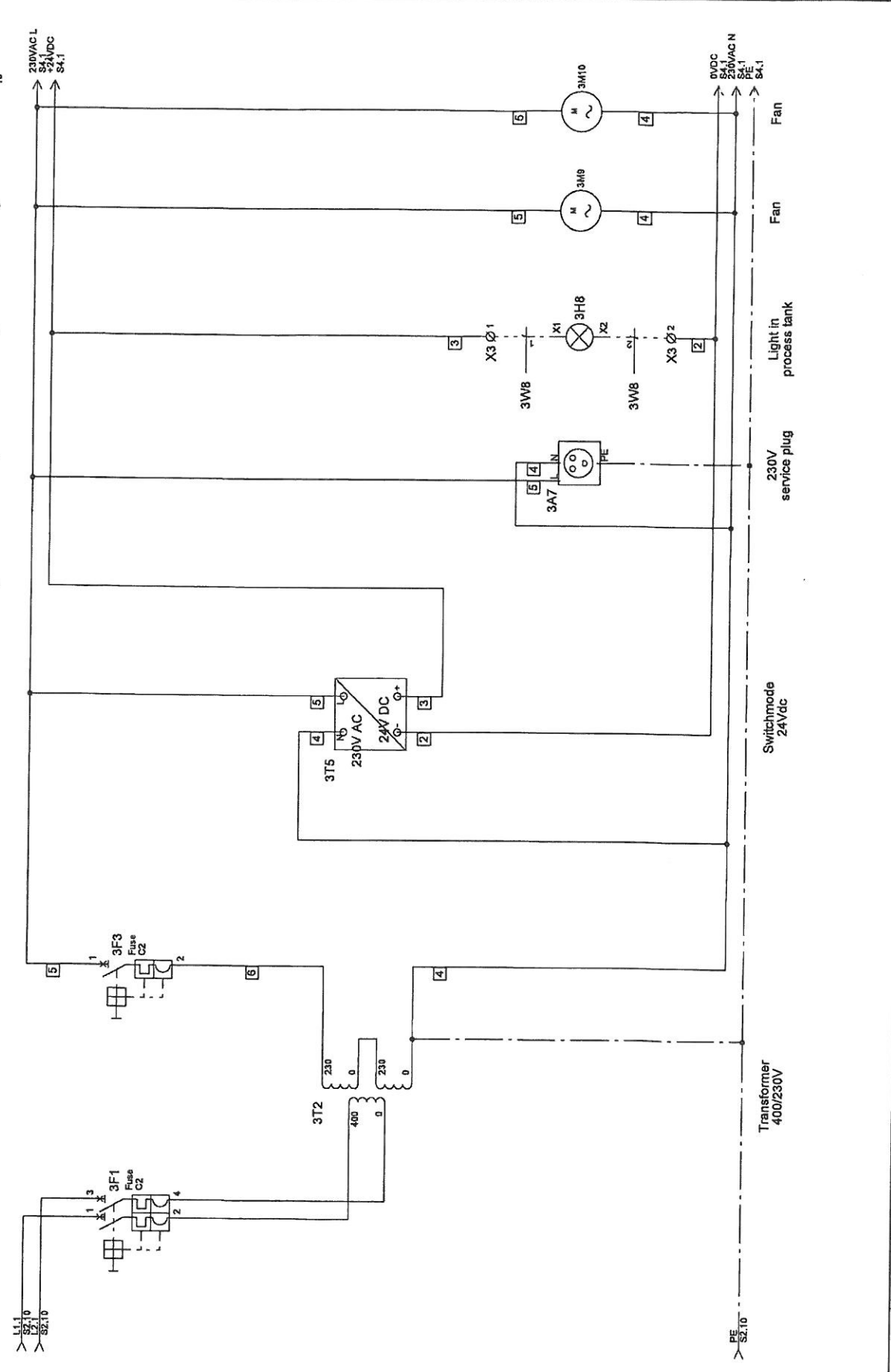

 <p><b>Nordland Automatic</b> Ingenjör- och installatörfirma Hydrobrukväg 80 8000 Åsbyrg Tel. +46 86512020</p>	Customer: Scanima AS	Case No.: D05114
	Project file: Testuser SRB-100	Order No.: 11346
	Page title: Power supply	Rev.:
	Scanima no.: 9106	Page latest change: 20-05-05

Page 3 of 19

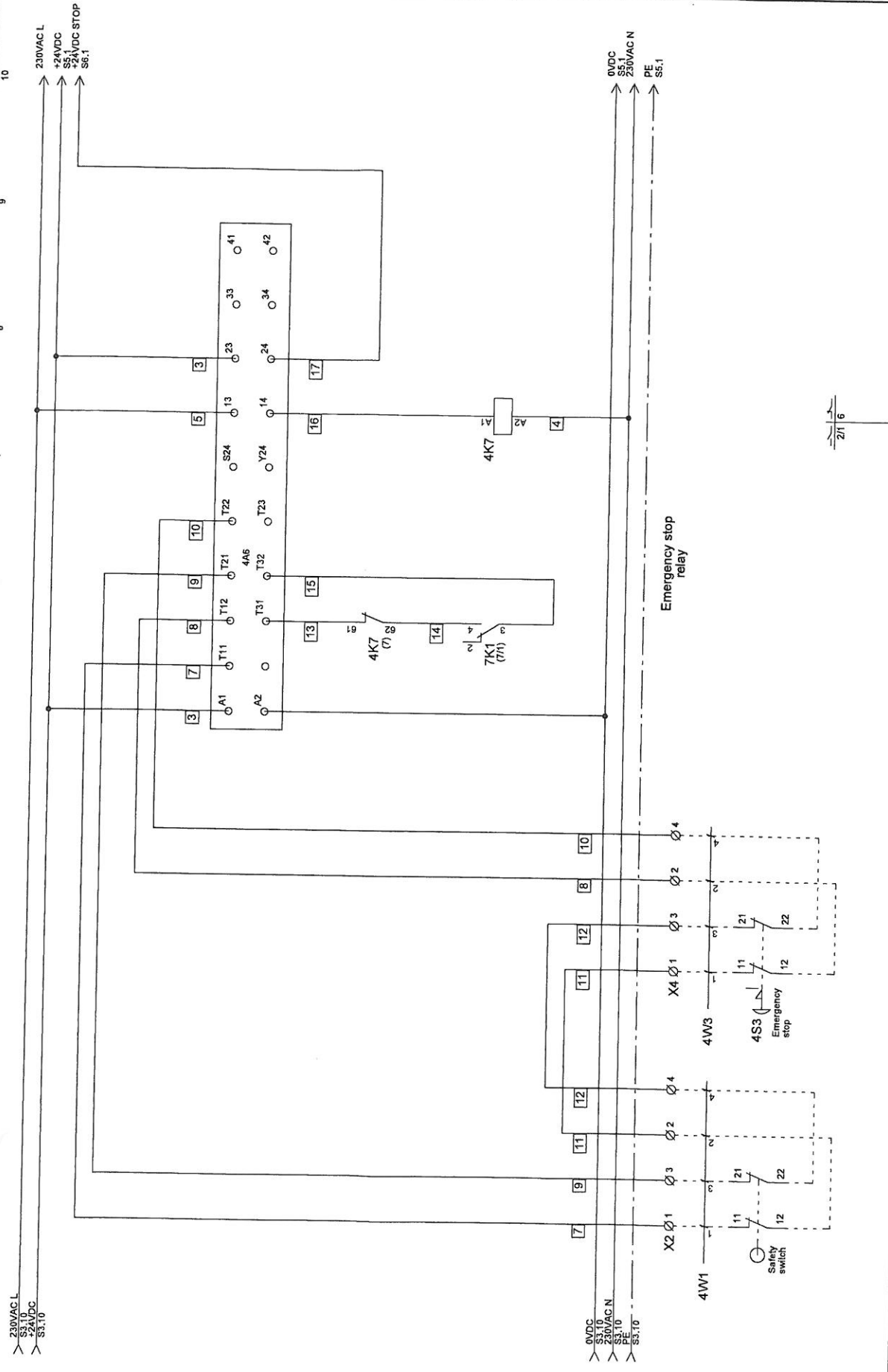

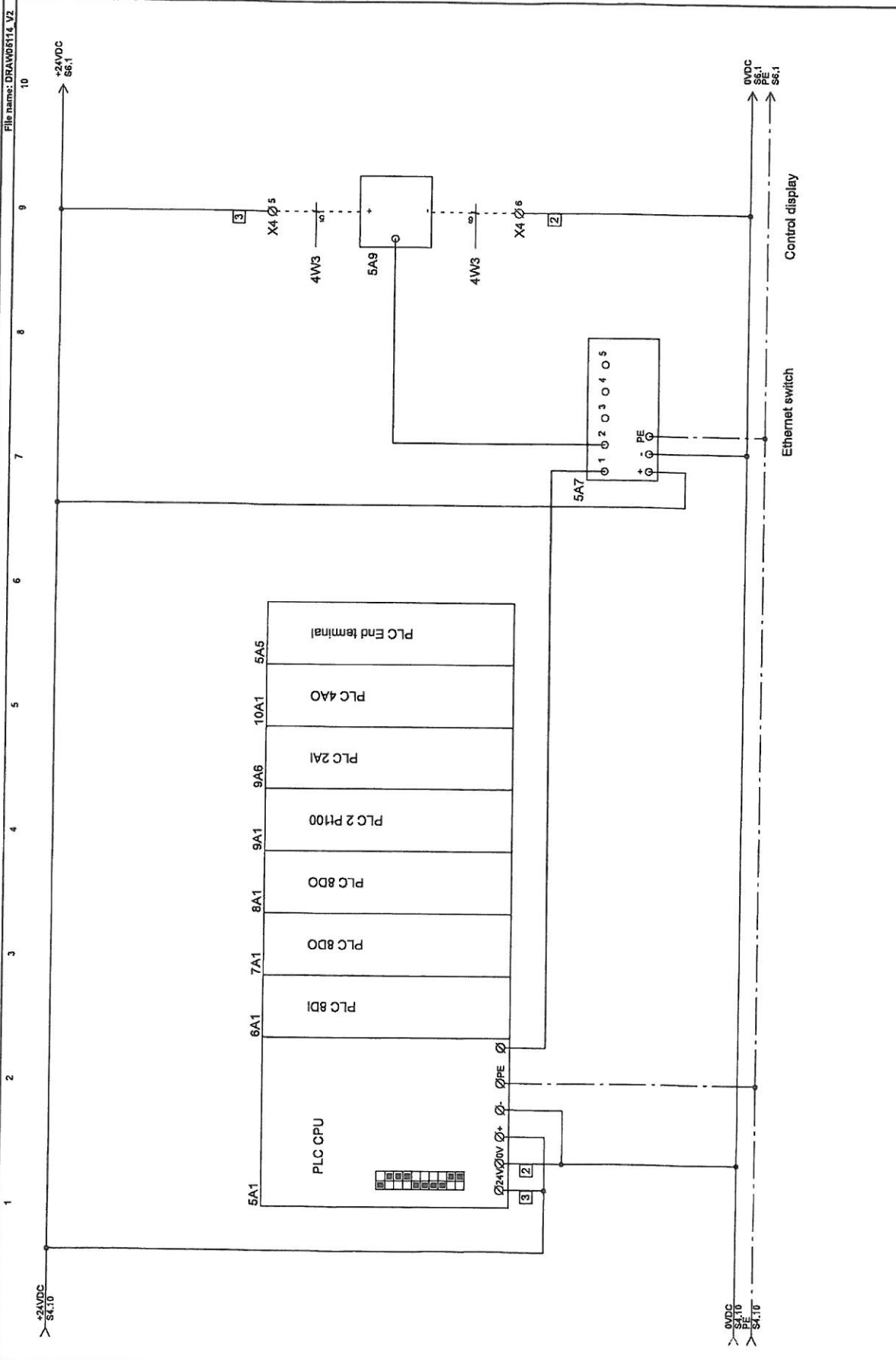



> +24VDC  
 > S5.10  
 > +24VDC STOP  
 > S4.10

> +24VDC  
 > S7.1

> 0VDC  
 > PE.10  
 > S5.10

> 0VDC  
 > SZ.1  
 > PE  
 > ST.1

Emergency stop OK	Thermo failure Mixer	Thermo failure Stirrer	Thermo failure Vacuum pump	Available	Available	Available
-------------------	----------------------	------------------------	----------------------------	-----------	-----------	-----------



**Nordland Automatic**  
 Ingeniør-og installerfirma  
 Hadsundvej 80 9000 Aalborg  
 Tlf. +45 96312020

Customer: Scanima AIS  
 Project title: Testmixer SRB-100  
 Page title: PLC Digital Input  
 Scanima no.: 9006

Case No.: D05114  
 Order No.: 1346  
 Rev.:

+24VDC  
SB.1

1 2 3 4 5 6 7 8 9 10

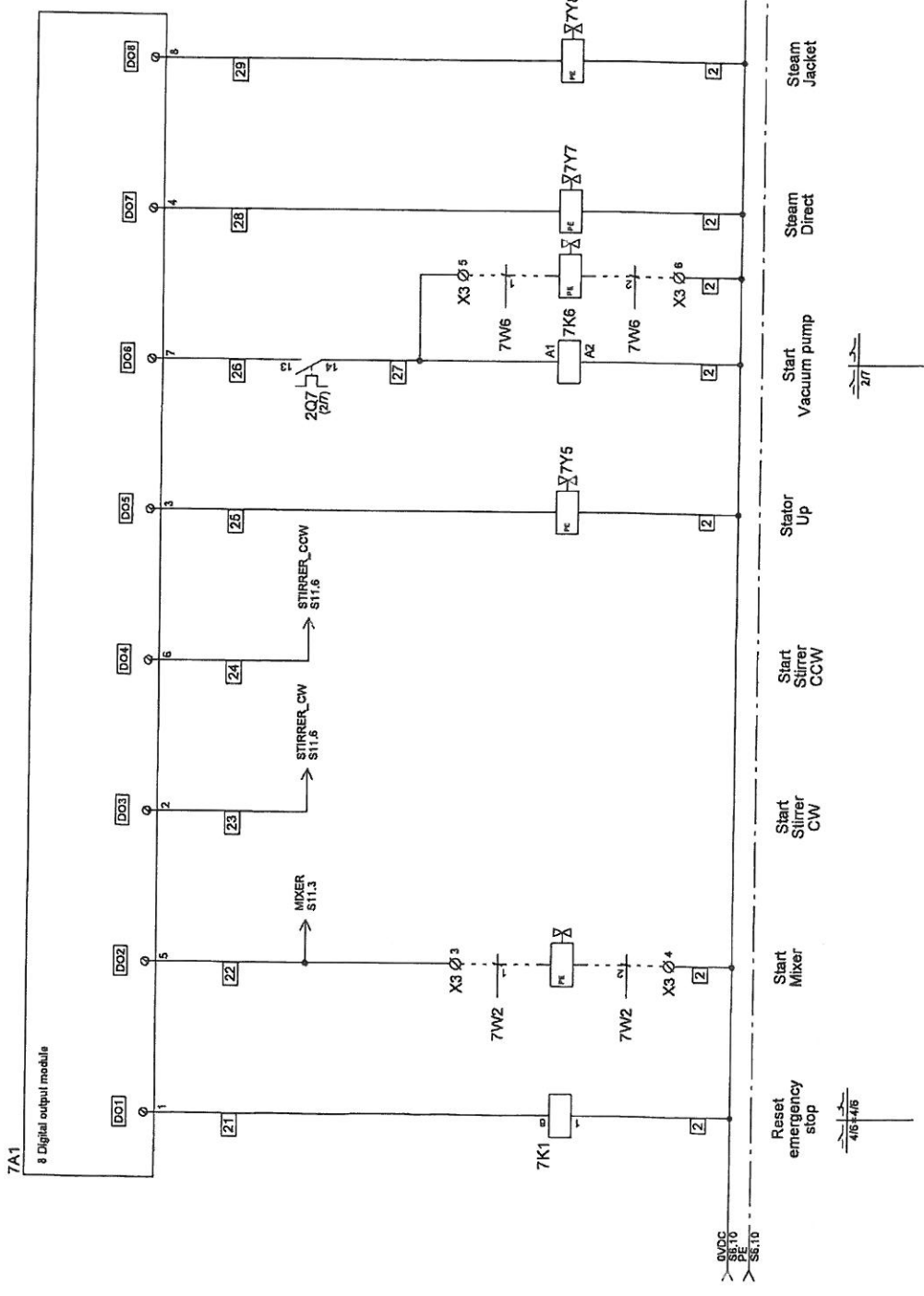

<p><b>Nordland Automatic</b>                  Ingeniør- og installerfirma                  Høvedsvej 89 9000 Aalborg                  Tlf. +45 96312020</p>		<p>Customer: Scania AS                  Project title: Tanker SRB-100                  Page title: PLC Digital Output                  Scanline no.: 9008</p>	<p>Confir.: Carsten P.                  Date: 13-10-05                  Rev.:</p>	<p>Case No.: D05114                  Order No.: 11346                  Page 7 of 19</p>
---	--	---	---	---

1 2 3 4 5 6 7 8 9 10

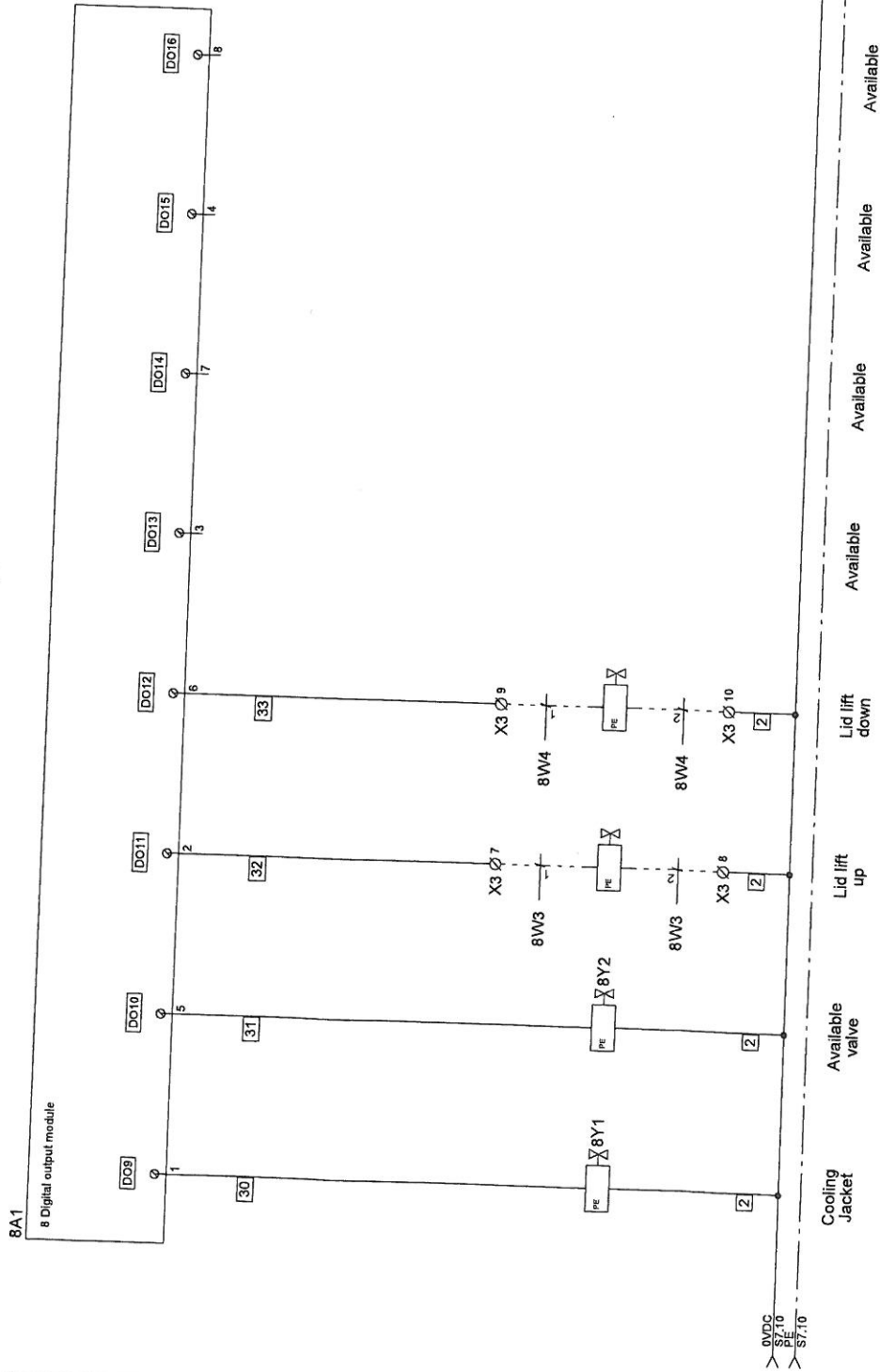

**Nordland Automatic**  
Ingeniør- og installatørfirma  
Hadsundvej 80 9000 Aalborg  
Tlf. +45 963312020

Customer: Scanima A/S  
Project title: Testmøder SRB-100  
Page title: PLC Digital Output  
Scanima no.: 9006

Case No.: D05114  
Order No.: 11346  
Rev.:  
Page latest change: 26-05-05  
Page 8 of 19

> +24VDC S10.1  
 > 0VDC S10.1  
 > PE S10.1  
 > SE1.10

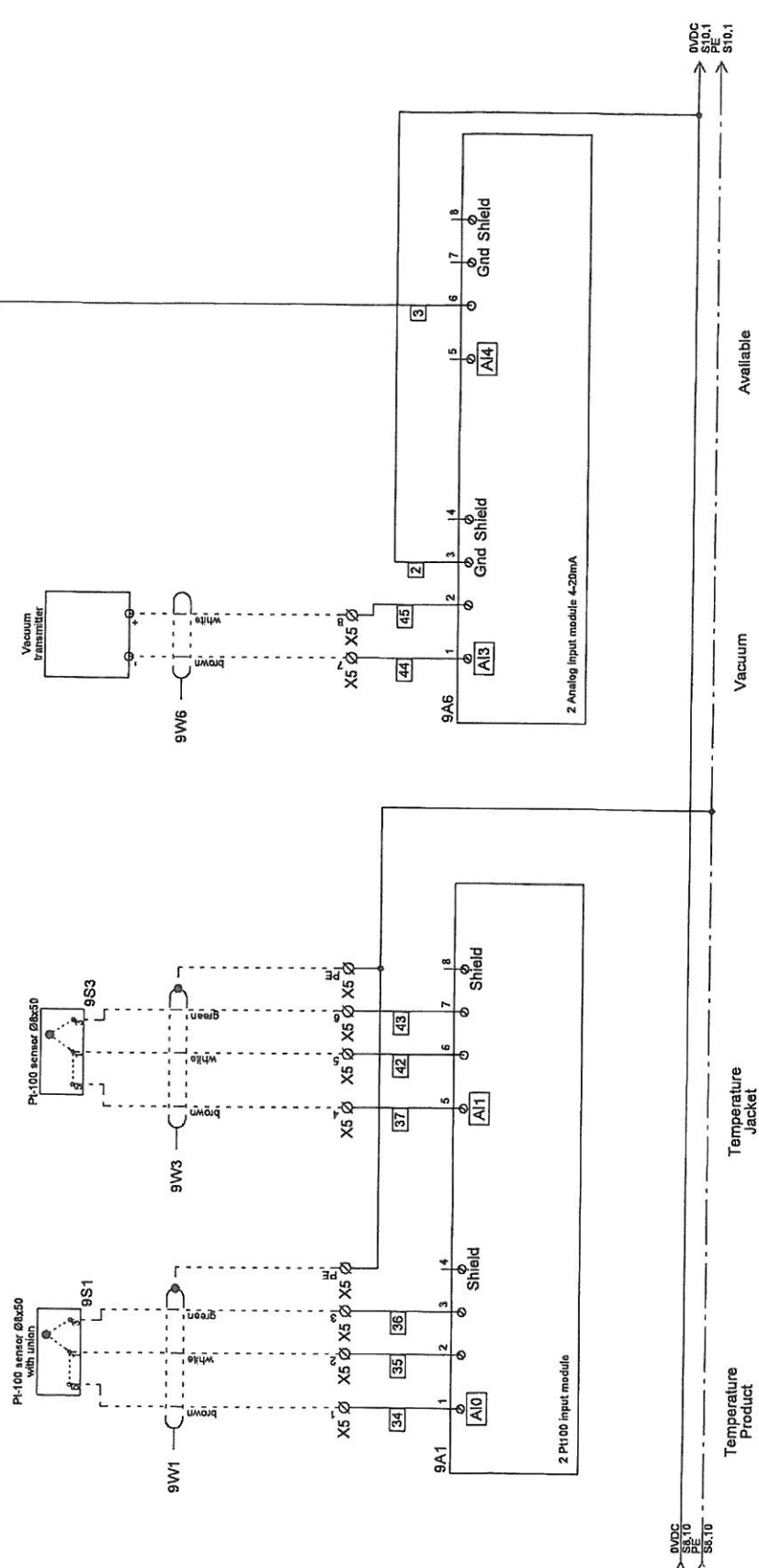

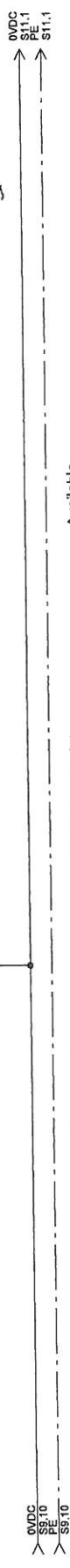
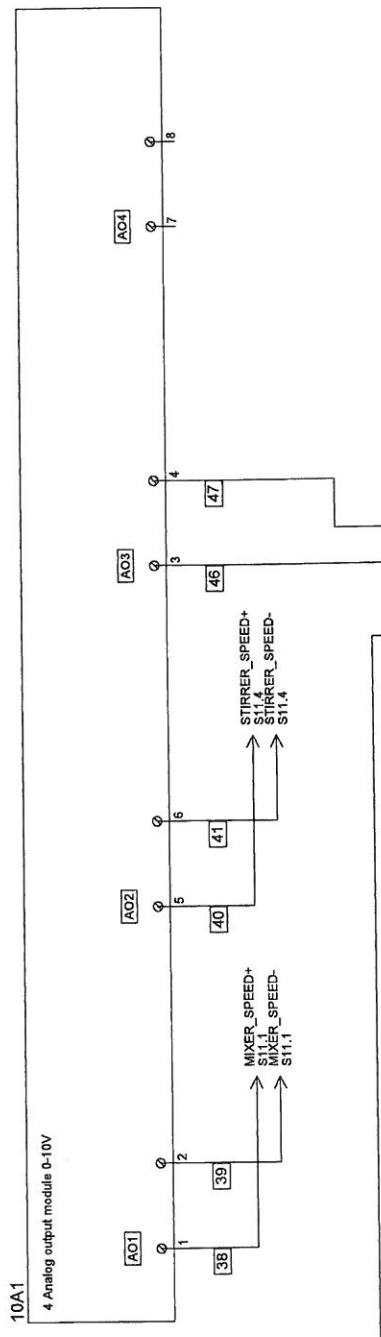



Mixer speed 0-10V = 0-100%  
 Stirrer speed 0-10V = 0-100%  
 Vacuum setpoint 0-10V = 0-100%  
 Available

		Customer: Scanima A/S Project title: Testmixer SRB-100 Page title: PLC Analog Output Scanima no.: 9006	Case No.: D05114 Order No.: 11346 Rev.: Page latest change: 28-05-05
Ingeniør- og installatørfirma Hadsundvej 80 9000 Aalborg Tlf. +45 96312020		Page 10 of 19	

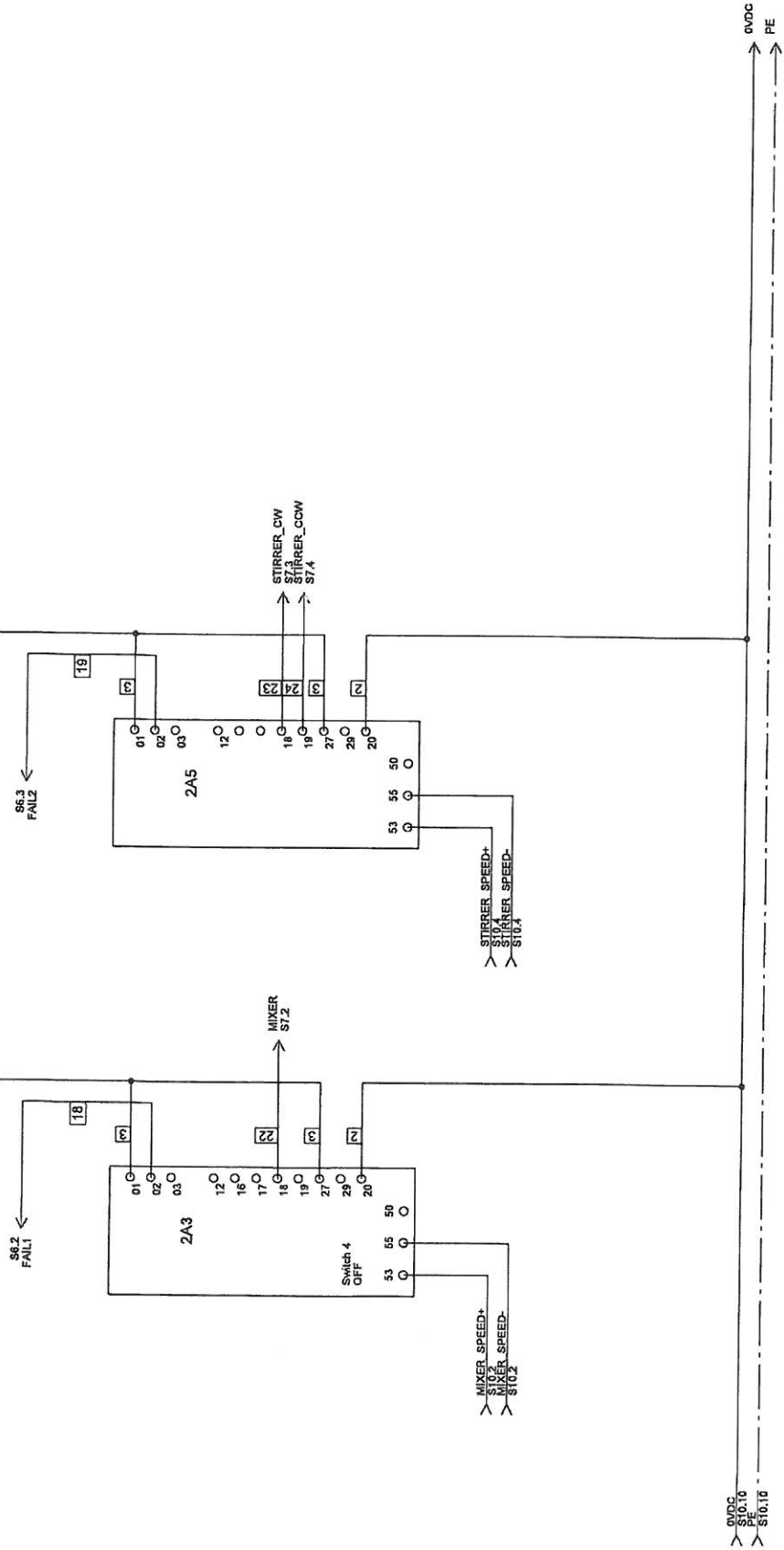
> +24VDC \$10.10 < < +24VDC



> 0VDC \$10.10 < < 0VDC PE \$10.10

 <p><b>Nordland Automatic</b> Ingeniør-og installatørfirma Hedemøvej 80 8000 Aalborg Tlf. +45 86312020</p>	<p>Customer: Scanlima AS Project title: Tømmer SRB-100 Page title: Mixer start-stop + Stirrer start-stop Scanline no.: 9006</p>	<p>Contact: Carsten P. Date: 13-10-05 Rev.:</p>	<p>Case No.: D05114 Order No.: 11346 Page latest change: 19-09-05 Page 11 of 19</p>
---	---	---	---

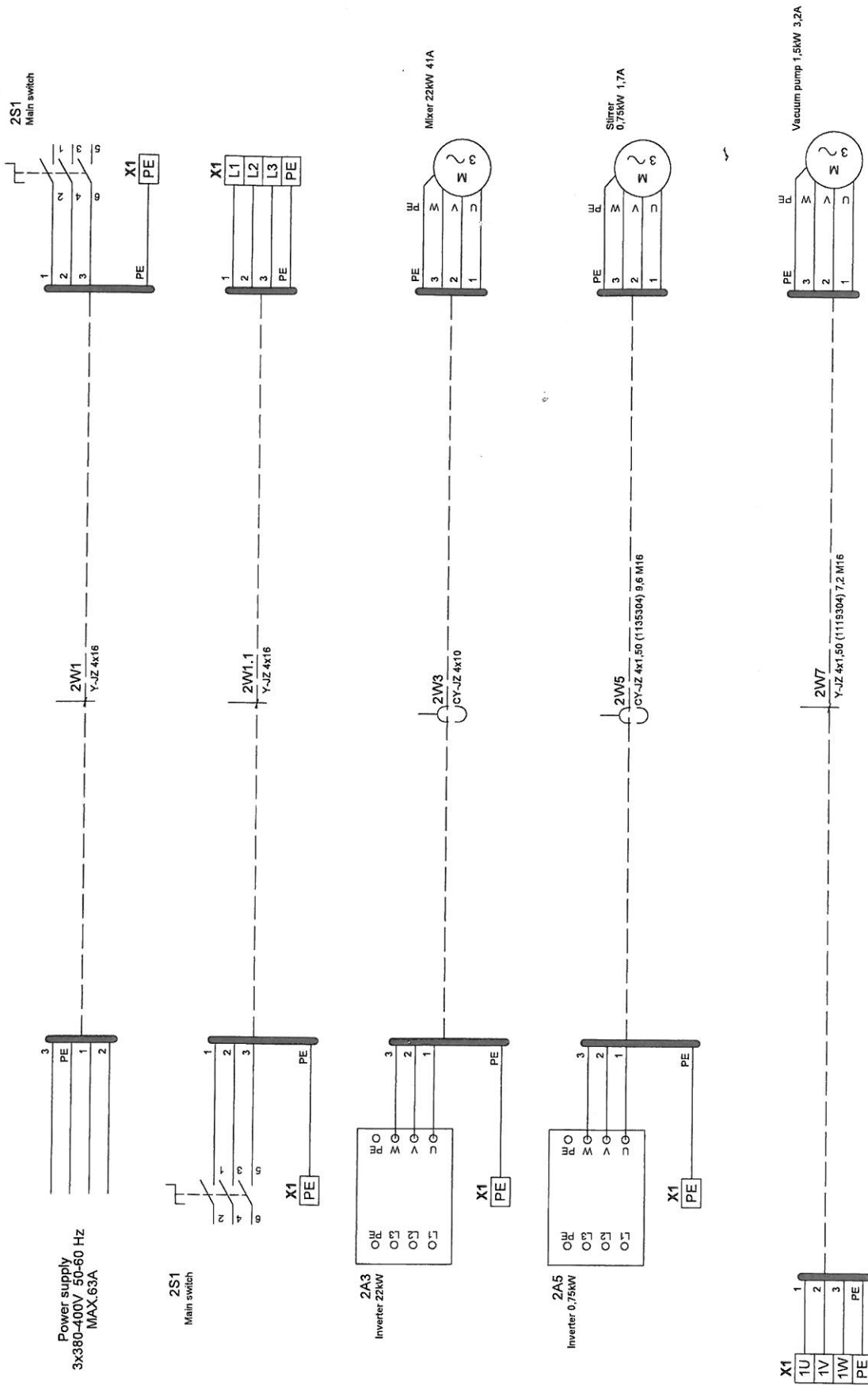

**Nordland Automatic**  
 Ingeniør-og installerfirma  
 Hadsundvej 80 9000 Aalborg  
 Tlf. +45 96312020

Kunde: Scania AS  
 Projekt titel: Testmixer SRB-100  
 Sidefelt: Cable-terminal list  
 Scania no.: 9006

Konstr.: Carsten P.  
 Godk.:  
 Sidefelt udskr: 13-10-05 08.43  
 Sidefelt sendt: 14-09-05 07.24

Sags nr: D05114  
 Ordre nr.: 11346  
 Rev.:  
 Side 12 af 19

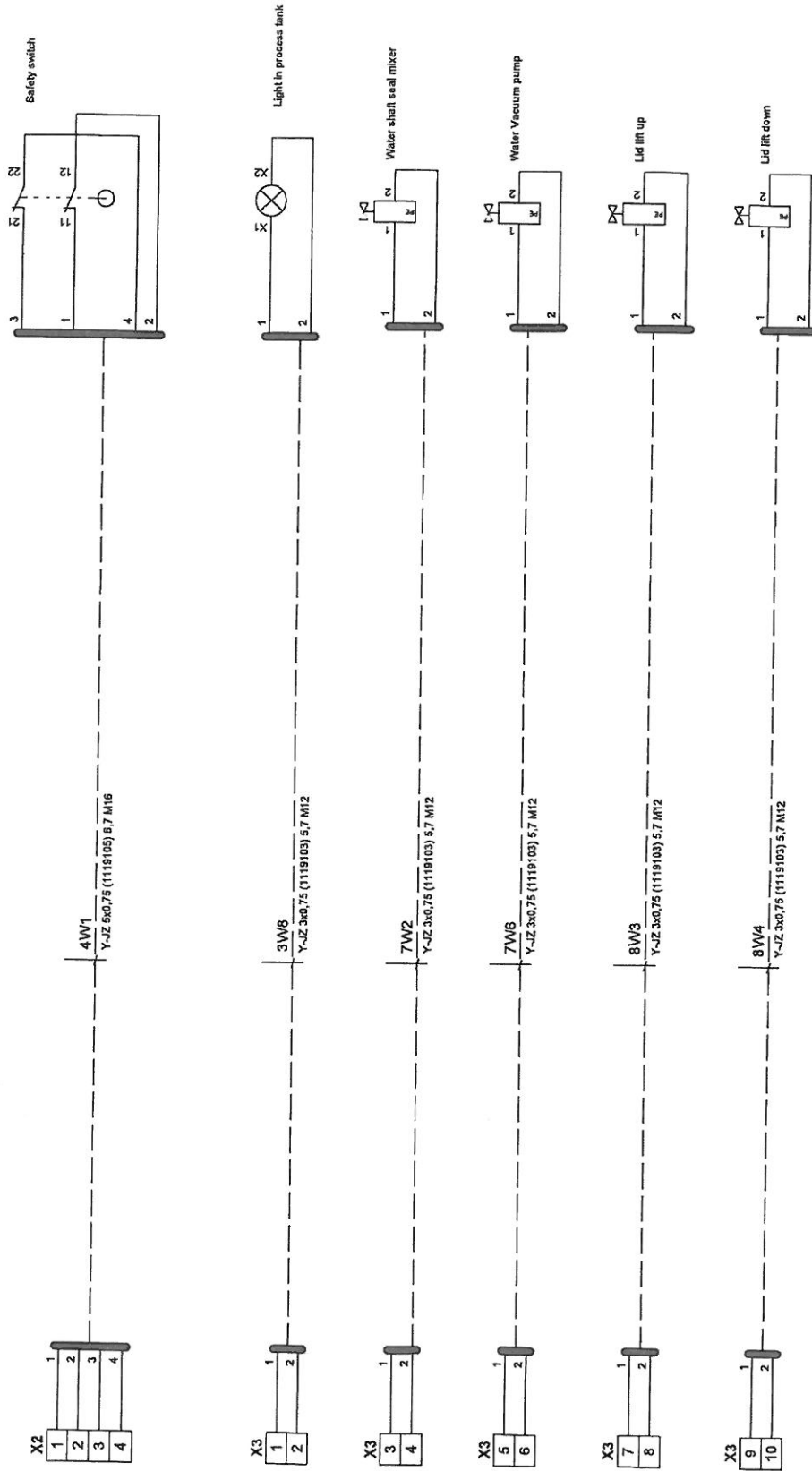

**Nordland Automatic**  
 Ingeniør- og Installørfirma  
 Hadsundvej 80, 8000 Aalborg  
 Tlf. +45 96312020

Kunde: Scanima A/S  
 Projekt titel: Testmixer SRB-100  
 Sidefelt: Cable-terminal list  
 Scanima no.: 9006

Konstr.: Carsten P.  
 Godk.:  
 Sidelst. udskr.: 13-10-05  
 Rev.: 08-03

Sage nr.: D05114  
 Ordre nr.: 11348  
 Rev.:  
 Side: 13 af 19

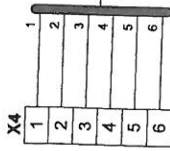
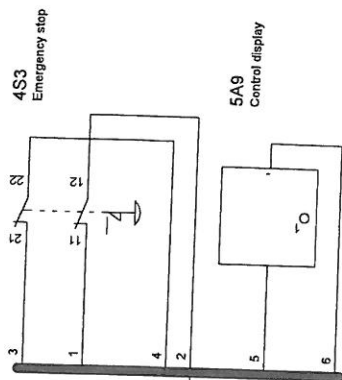

4W3  
Y-JZ 7x0,75 (1119107) 7,3 M16

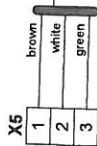

9W1  
L1CY 4x0,50 (0034604) 6,3 M12

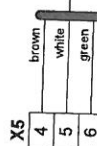
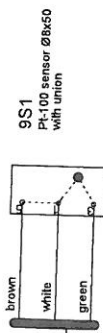

9W3  
L1CY 4x0,50 (0034604) 6,3 M12

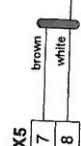
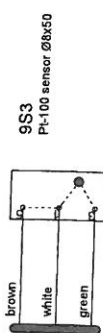

9W6  
L1CY 2x0,50 (0034602) 5,5 M12

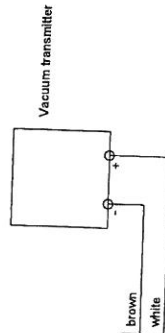

**Nordland Automatic**  
Ingeniør- og installatørfirma  
Hadsundvej 80, 9000 Aalborg  
Tlf. +45 96372020

Kunde: Scanima A/S  
Projekt titel: Testmikser SRB-100  
Sidetitel: Cable-Terminal list  
Scanima no.: 9006

Sags nr.: D05114  
Ordre nr.: 1346  
Rev.:  
08.43  
08.19

X6	
1	brown
2	white
3	green
4	yellow

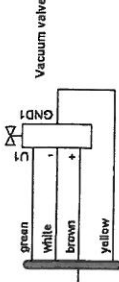
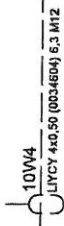

**Nordland Automatic**  
 Ingeniør- og installatørfirma  
 Hadsundvej 80 8000 Aalborg  
 Tlf. +45 96312020

Kunde: Scanima A/S  
 Projekt titel: Teakbiler SRB-100  
 Sidefelt: Cabel-terminallist  
 Scanima no.: 9008

Konst.-Carsten P.  
 Gedl.  
 Sidef. udsk.: 13-10-05 08-43  
 Sidef. ændret: 23-08-05 09:28  
 Sags nr.: D05114  
 Ordre nr.: 11346  
 Rev.:  
 Side 15 af 19

# Part list

Code	Function	Manufacture	Type number	Number	Qt
1A1.1	Control Box 300x300x150	ENSTO	ESSP303015	6418677179532	1
2A3	Inverter 22kW		Scanima delivery	Scanima_	1
2A5	Inverter 0,75kW		Scanima delivery	Scanima_	1
2F5	Fuse C10	Merlin Gerin	24349	3303430243496	1
2Q7	Circuit breaker	Allen Bradley	140A-C2A-B40	5703847856568	1
2Q7	Circuit breaker	Allen Bradley	140A-C-ASA11	5703847856650	1
2S1	Main switch	Allen Bradley	194E-E80-1753	5703847167879	1
2S1	Main switch	Allen Bradley	194E-G3665M	5703847168579	1
2S1	Main switch	Allen Bradley	194L-HE6G-175	5703847261102	1
3A7	230V service plug	Shupa	PC 16/2	4011598004734	1
3F1	Fuse C2	Merlin Gerin	24332	3303430243328	1
3F3	Fuse C2	Merlin Gerin	24306	3303430243069	1
3M9	Fan	Cosmotec	GNV300A220 500	5703722012829	1
3M10	Fan	Cosmotec	GNV300A220 500	5703722012829	1
3T2	Transformer 400/230V	Block	STEU250/23	5703722210621	1
3T5	Switchmode 24Vdc	OMRON	S8PS-10024CD	4536854637483	1
4A6	Emergency stop relay	Omron	G9SB-301-D	4536854736612	1
4K7	Contactora	Allen Bradley	100-C60KF00	5703847117454	1
4K7	Element for contactora	Allen Bradley	100-FA11	5703847119151	1
4S3	Emergency stop	Allen Bradley	800EP-MTS44	5703847038599	1
4S3	Emergency stop	Allen Bradley	800E-3X01	5703847081199	2
4S3	Emergency stop	Allen Bradley	800E-A3L	5703847082035	1
4S3	Emergency stop	Allen Bradley	800E-15YE112	5703847088297	1
5A1	PLC CPU	Wago	750-842	4017332707909	1
5A5	PLC End terminal	Wago	750-600	4017332250283	1
5A7	Ethernet switch	MOXA	EDS-205	2305	1
5A9	Control display	Pro-face	GP2300-SC41-24V	GP2300-SC41	1
6A1	8 Digital input module	Wago	750-430	07500430	1
7A1	8 Digital output module	Wago	750-530	51037593	1
7K1		Omron	P2RF-08-E	4536854361197	1
7K1	Relay	Omron	G2R-2-SN 24VDC	4536854936852	1
7K6	Contactora	Allen Bradley	100-M09NZ243	5703847122670	1
7Y5	Stator valve	Bürkert	017468T	017468T	1
7Y7	Steam direct valve	Bürkert	017467J	017467J	1
7Y8	Steam jacket valve	Bürkert	017467J	017467J	1
8A1	8 Digital output module	Wago	750-530	51037593	1
8Y1	Cooling valve	Bürkert	017467J	017467J	1
8Y2	Vacuum valve	Bürkert	017467J	017467J	1
9A1	2 Pt100 input module	Wago	750-461	4017332257800	1
9A6	2 Analog input module 4-20mA	Wago	750-466	4017332256490	1
9S1	Pt-100 sensor Ø8x50 with union	Lund & Sørensen	PT100 ½" Ø8x50 UNION	9M010207	1
9S3	Pt-100 sensor Ø8x50	Lund & Sørensen	PT100 ½" Ø8x50	9M011035	1
10A1	4 Analog output module 0-10V	Wago	750-559	07500559	1
X1	Terminal 4mm²	Allen Bradley	1492-W4	5703847281995	3
X1	Terminal 16mm²	Allen Bradley	1492-W16S	5703847282176	3
X2	Terminal 4mm²	Allen Bradley	1492-WD4	5703847282497	2
X3	Terminal 4mm²	Allen Bradley	1492-WD4	5703847282497	5



**Nordland Automatic**  
 Ingeniør-og installatørfirma  
 Hadsundvej 80 9000 Aalborg  
 Tlf. +45 96312020

Customer: Scanima A/S

Date: 13-10-05

Project title: Testmixer SRB-100

Case no.: D05114

Order no.: 11346

Scanima no.: 9006

Page 16 of 19



# I/O List

Name	I/O	Description	Component
6A1:1	DI1	Emergency stop OK	4A6:24
6A1:5	DI2	Thermo failure Mixer	2A3:02
6A1:2	DI3	Thermo failure Stirrer	2A5:02
6A1:6	DI4	Thermo failure Vacuum pump	2Q7:22
6A1:3	DI5	Available	
6A1:7	DI6	Available	
6A1:4	DI7	Available	
6A1:8	DI8	Available	
7A1:1	DO1	Reset emergency stop	7K1:8
7A1:5	DO2	Start Mixer	7Y2:1
7A1:2	DO3	Start Stirrer CW	2A5:18
7A1:6	DO4	Start Stirrer CCW	2A5:19
7A1:3	DO5	Stator Up	7Y5:1
7A1:7	DO6	Start Vacuum pump	2Q7:13
7A1:4	DO7	Steam Direct	7Y7:1
7A1:8	DO8	Steam Jacket	7Y8:1
8A1:1	DO9	Cooling Jacket	8Y1:1
8A1:5	DO10	Available valve	8Y2:1
8A1:2	DO11	Lid lift up	8Y3:1
8A1:6	DO12	Lid lift down	8Y4:1
8A1:3	DO13	Available	
8A1:7	DO14	Available	
8A1:4	DO15	Available	
8A1:8	DO16	Available	
9A1:1	AI0	Temperature Product	9S1:5
9A1:5	AI1	Temperature Jacket	9S3:5
9A6:1	AI3	Vacuum	9S6:-
9A6:5	AI4	Available	
10A1:1	AO1	Mixer speed 0-10V = 0-100%	2A3:53
10A1:5	AO2	Stirrer speed 0-10V = 0-100%	2A5:53
10A1:3	AO3	Vacuum setpoint 0-10V = 0-100%	10Y5:U1
10A1:7	AO4	Available	

# Scanima A/S

## DECLARATION OF CONFORMITY

We Nordland Automatic A/S  
Hadsundvej 80  
DK-9000 Aalborg  
Denmark

declare that the machinery/machinery part/equipment  
(name, type, serial number, etc.)

**Electrical controls of: Testmixer SRB-100**  
**Drawing no.: D05114**

is in conformity with the following harmonized standards:

EN 60 204-1:2000  
EN 418:1992  
EN 954-1  
EN 50 081-2  
EN 50 082-2

Following the provisions of the Directive(S) including amendments:

98/37/EEC (machinery)  
89/336/EEC (electromagnetic compatibility)  
73/23/EEC (electrical equipment designed for use within  
certain voltage limits)

Done at Nordland Automatic A/S  
Hadsundvej 80  
DK-9000 Aalborg  
Denmark

Date: 13-10-05



Simon Lauth Christensen

Technical Manager  
(signature and job title)



**Nordland Automatic A/S**  
ingeniør-og installatørfirma  
Hadsundvej 80 900 Aalborg  
Tlf. +45 96 312020  
Fax. +45 96 312021  
e-mail:nordland@nordland.dk

Customer: Scanima A/S

Date: 13-10-05

Project title: Testmixer SRB-100

Case no.: D05114

Order no.: 11346

Scanima no.: 9006

Page: 19

of 20