

GENESYS™ 10 Series Spectrophotometers

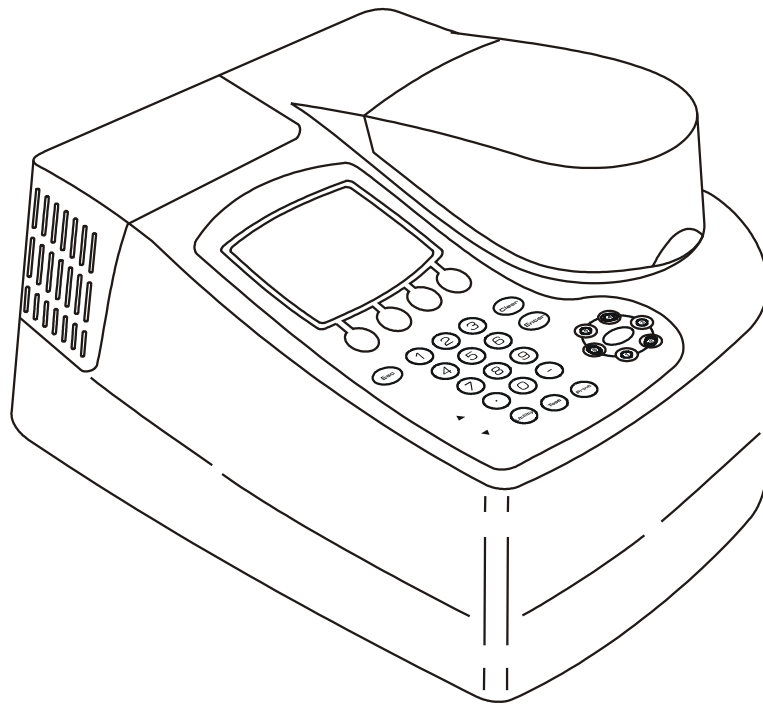

Thermo
ELECTRON CORPORATION

Operator's Manual

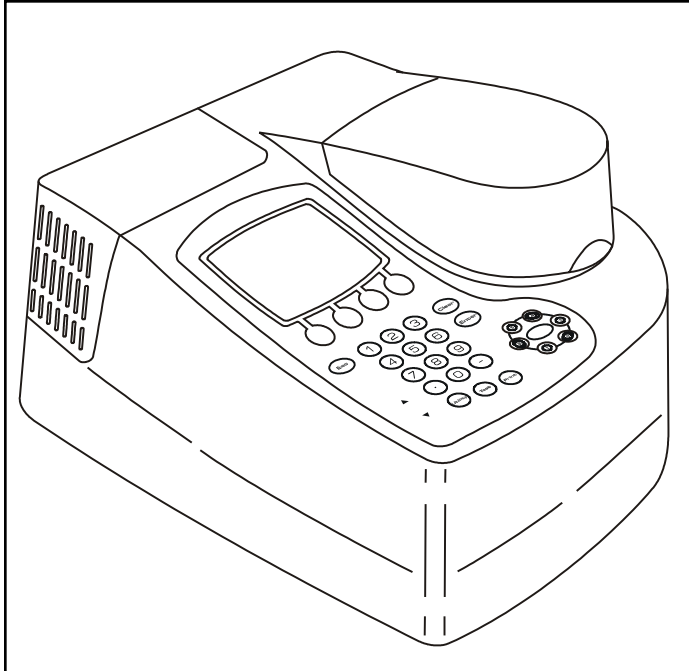

Figure 1 GENESYS 10 spectrophotometer

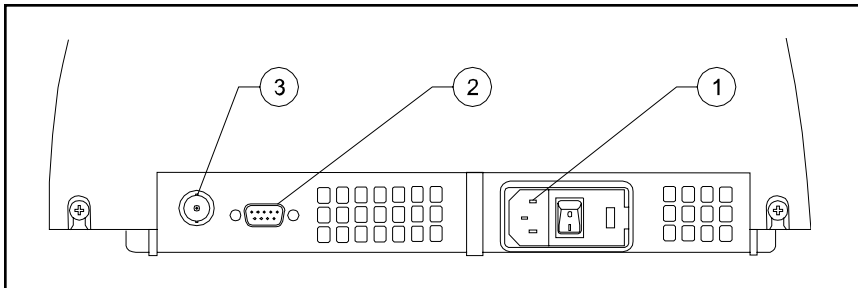

Figure 2a Back panel of the GENESYS 10 Vis and GENESYS 10 UV spectrophotometer

Key

- ① A/C power connector
- ② RS232C port
- ③ Analog/BNC connector

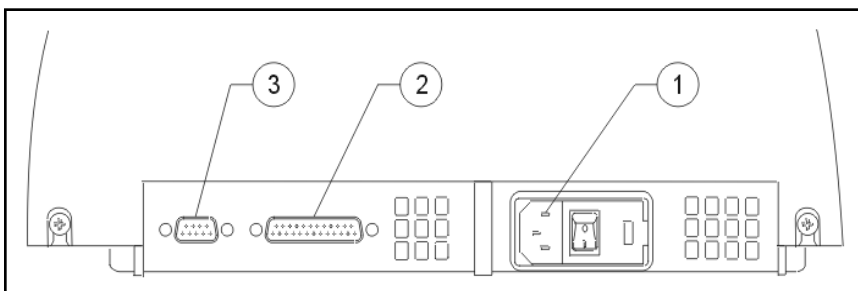
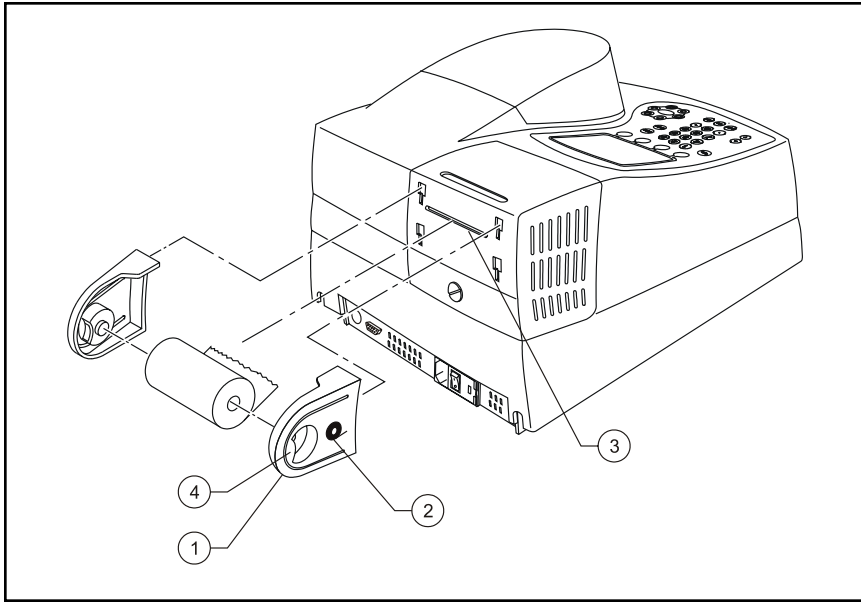

Figure 2b Back panel of the GENESYS 10 UVscanning spectrophotometer

Key

- ① A/C power connector
- ② Parallel port
- ③ RS232C port



Key

- ① Paper roll holder
- ② Icon for paper direction
- ③ Paper entry slot
- ④ Finger tab

Figure 3 Installing the paper roll holders for the internal printer (335988)

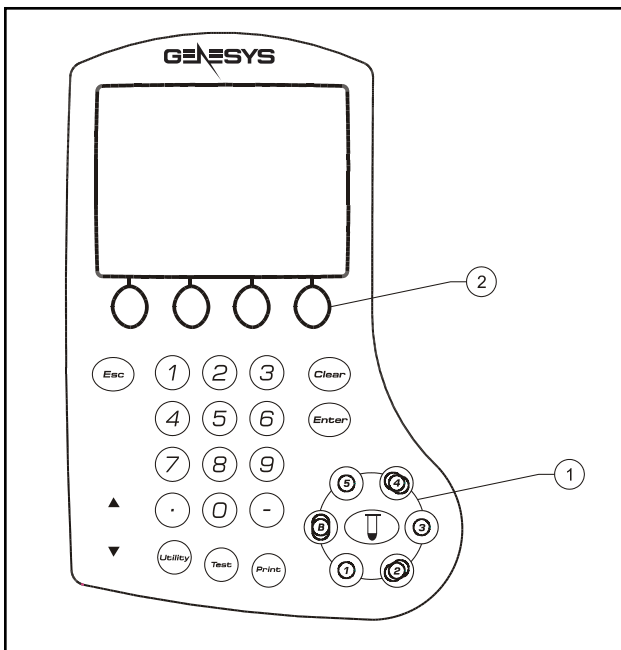

Key

- ① Cell position keys
[for 6-Position Cell Holder]
- ② Function keys

Figure 4 Keypad of the GENESYS 10 spectrophotometer

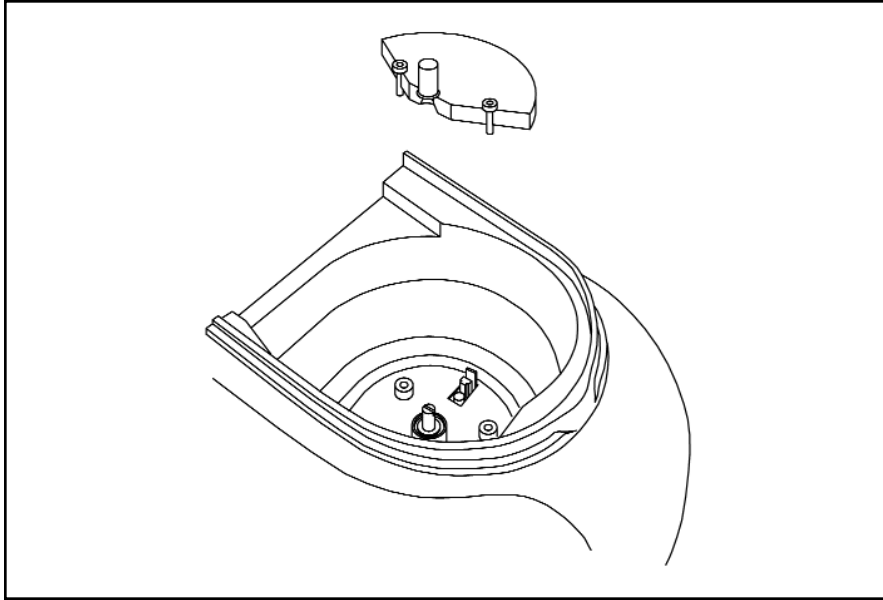
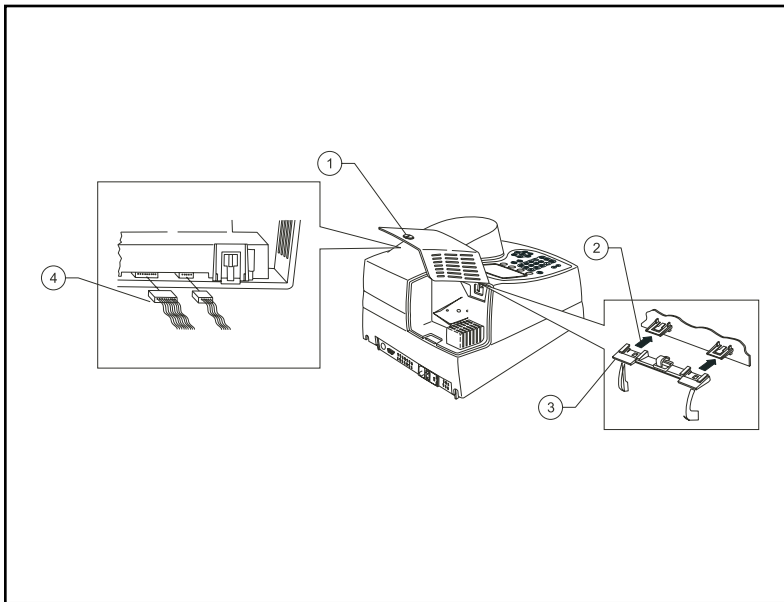

Figure 5 Installing the Single-Position Cell Holder (335916)



Key

- ① Captive screw on lamp door
- ② Removing door from hinge
- ③ Hinge
- ④ Connecting wires to printer

Figure 6 Installing the printer (335988)

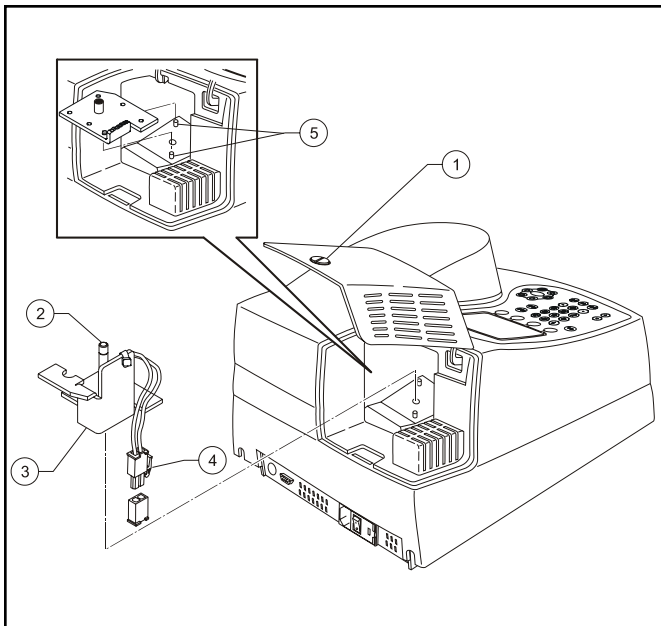

Key

- ① Captive screw on lamp door
- ② Thumbscrew
- ③ Lamp assembly
- ④ Tab on cable connector
- ⑤ Aligning the lamp assembly

Figure 7 Replacing the tungsten lamp in GENESYS 10Vis spectrophotometer

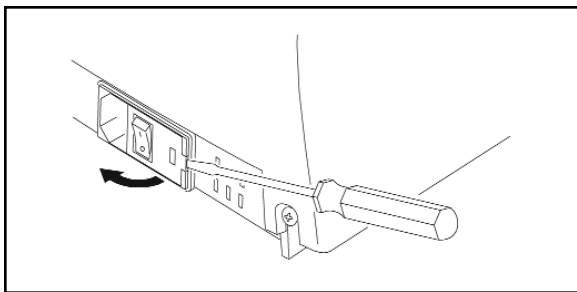

Figure 8 Removing the cover of the fuse compartment

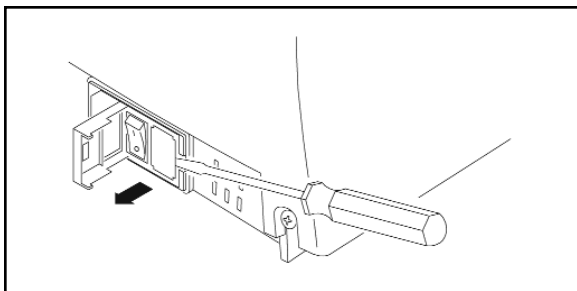

Figure 9 Removing the fuse holder

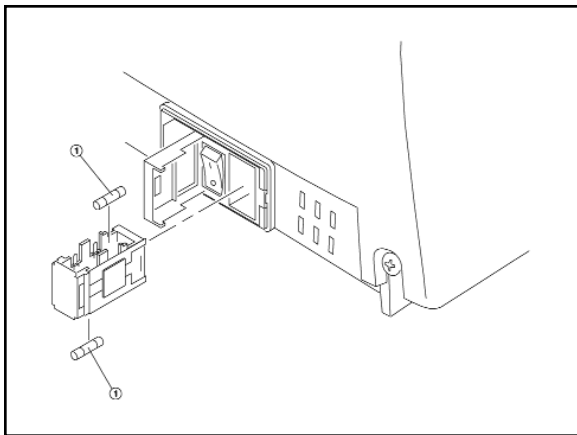

Figure 10 Removing and replacing the fuses

Declaration of Conformity

(For instruments manufactured after July 1, 2001)

Model: GENESYS™ 10 Series
Catalog Nos.: 335900, 335900A, 335900P, 335900AP, 335901, 335901A, 335901P, 335901AP
335902, 335902A, 335902P, 335902AP, 335903, 335903A, 335903P, 335903AP
335906, 335906P, 335907, 335907P

Model: BioMate™ 3
Catalog Nos.: 335904, 335904P, 335905, 335905P

Model: GENESYS™ 6
Catalog Nos.: 335908, 335908P

North American Plug (NEMA 5-15) Numbers above
European Plug (CEE 7/7 Schuko) Add a -02 suffix
United Kingdom Plug (BS 1363/A) Add a -04 suffix

Thermo Electron Scientific Instrument Corporation certifies that the **GENESYS 10, GENESYS 6, and BioMate 3 Spectrophotometers** have been tested according to the instrumentation standards listed in this section in compliance with IEC directives and other regulatory requirements. The equipment under test (EUT) consisted of a sample instrument and applicable accessories, which are manufactured by Thermo Electron Scientific Instrument Corporation. The EUT was configured to ensure that both the worst case condition, and that all of the accessories were tested. This equipment has been tested for use in non-residential environments.

IEC Directives

89/336/EEC Electromagnetic Compatibility Directive
73/23/EEC Low Voltage Directive

Electromagnetic Compatibility Test Standards

IEC 61326-1 1998, Electrical Equipment for Measurement, Control, and Laboratory use - EMC Requirements. Class A Limits
IEC 61000-4-2 1999, Electrostatic Discharge Immunity Test (Test level: 4KV Air Discharge and 4 KV Contact Discharge)
IEC 61000-4-3 1998, Radiated, Radio Frequency, Electromagnetic Field Immunity Test (Test level: 3V/m)
IEC 61000-4-4 1995, Electrical Fast Transient/Burst Immunity Test (Test level: 1KV on the supply lines)
IEC 61000-4-5 1995, Surge Immunity Test (Test level: 0.5KV line to line and 1KV line to earth on the supply lines)
IEC 61000-4-6 1996, Immunity to Conducted Disturbances, Induced by Radio-Frequency Fields (Test level: 3V on the supply lines)
IEC 61000-4-11 1994, Voltage Dips, Short Interruptions, and Voltage Variations Test Level: 1 cycle/100%
CISPR 16-2 1999, Specification for Radio Disturbance and Immunity Measuring Apparatus and Methods—
Methods of Measurement of Disturbances and Immunity

Safety Test Standards

IEC 61010-1 1990 + A1 1992 +A2 1995. Safety requirements for Electrical Equipment for Measurement, Control and Laboratory use.

CSA C22.2 No. 1010.1, plus Am 2

IEC 61010-1 1997, Safety requirements for Electrical Equipment for Measurement, Control and Laboratory use;
Part 1: General Requirements Test level: Installation Category II, Pollution Degree 2

Authorized signature:



Brenda Wilcox
Vice President, Molecular Spectroscopy

Date: 27May03

The information in this publication is provided for reference only. All information contained in this publication is believed to be correct and complete. Thermo Electron Scientific Instruments Corporation shall not be liable for errors contained herein nor for incidental or consequential damages in connection with the furnishing, performance or use of this material. All product specifications, as well as the information contained in this publication, are subject to change without notice.

This publication may contain or reference information and products protected by copyrights or patents and does not convey any license under our patent rights, nor the rights of others. We do not assume any liability arising out of any infringements of patents or other rights of third parties.

We make no warranty of any kind with regard to this material including, but not limited to, the implied warranties of merchantability and fitness for a particular purpose.

Copyright © 2003 by Thermo Electron Scientific Instruments Corporation, Madison, WI 53711. Printed in the United States of America. All world rights reserved. No part of this publication may be stored in a retrieval system, transmitted, or reproduced in any way including, but not limited to, photocopy, photograph, magnetic, or other record, without the prior written permission of Thermo Electron Scientific Instruments Corporation.

For technical assistance, please contact:
THERMO ELECTRON CORPORATION
(North America, Asia Pacific, Middle East, Africa, India and Latin America)
5225 Verona Road, Madison, Wisconsin, 53711-4495 USA
Telephone: (800) 642-6538 or (608) 276-6373
Fax: (608) 273-5045
E-Mail: careplan.techsupport@thermo.com

THERMO ELECTRON CORPORATION
(Europe)
Mercers Row, Cambridge CB5 8HY, UK
Telephone: Int +44 (0) 1223 446655
Fax: Int +44 (0) 1223 446644
E-Mail: careplan.techsupport@thermo.com

SPECTRONIC is a registered trademark and GENESYS is a trademark of Thermo Electron Scientific Instruments Corporation.

Item No.: 335902-10001, Rev. E 06/03

Component No.: 335902-10063, Rev. E 06/03

GENERAL SAFETY NOTES USED IN THIS MANUAL



This symbol alerts you to important information about using the instrument. Be sure to read and follow the associated instructions carefully.

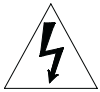

This symbol alerts you to potential electrical hazards. Be sure that only qualified personnel perform the related procedures.



This symbol alerts you to hot surfaces. Be sure to read and follow the associated instructions carefully.

NEW PRODUCT WARRANTY

Thermo Electron Scientific Instruments Corporation instrumentation and related accessories are warranted against defects in material and workmanship for a period of one (1) year from the date of delivery. This warranty is provided only if the warranty registration card is returned to Thermo Electron Scientific Instruments Corporation within fifteen (15) days after delivery.

This warranty covers parts (except those specified below) and labor, and applies only to equipment which has been installed and operated in accordance with the operator's reference guide and which has been serviced only by authorized Thermo Electron Scientific Instruments Corporation dealers or service personnel. This warranty does not apply to equipment and accessories that have been modified or tampered with in any way, misused, or damaged by accident, neglect, or conditions beyond Thermo Electron Scientific Instruments Corporation's control.

This warranty does not apply to lamps, glassware, and similar expendable components. However, such parts and components may be warranted by their manufacturer.

Thermo Electron Scientific Instruments Corporation is not responsible under this warranty for loss in operating performance due to environmental conditions.

THIS WARRANTY IS IN LIEU OF ALL WARRANTIES EXPRESSED, IMPLIED, OR STATUTORY, INCLUDING, BUT NOT LIMITED TO, WARRANTIES OF FITNESS FOR A PARTICULAR PURPOSE OR MERCHANTABILITY OR OTHERWISE, and states Thermo Electron Scientific Instruments Corporation's entire and exclusive liability and the Customer's exclusive remedy for any claim in connection with the sale or furnishing of services, goods, or parts, their design, suitability for use, installation, or operations. Thermo Electron Scientific Instruments Corporation will in no event be liable for any direct, indirect, special, or consequential damages, whatsoever, including loss of goodwill, whether grounded in tort (including negligence), strict liability or contract, and Thermo Electron Scientific Instruments Corporation's liability under no circumstances will exceed the contract price for the goods and/or services for which liability is claimed.

SOFTWARE PASSWORD

This password allows you to enter the security section of the software used on your spectrophotometer. Through the security section, you can "lock" test setups (test parameters) so that they may not be altered. The password also allows you to remove the security so that you may edit the test parameters. Please refer to the appropriate section in this Operator's Manual for more information on locking a test.

PASSWORD: 4 3 6 3 7 9 7

Table of Contents

CHAPTER 1 - Setting Up the Instrument

Instrument description.....	1-1
Setting up the instrument.....	1-1
Analog connections.....	1-1
Setting utility parameters	1-2
Selecting the language	1-2
Setting the date and time	1-2
Selecting standby settings.....	1-2
Setting baseline expiration time	1-3
Setting the screen contrast.....	1-3
Loading paper in the internal printer	1-3
Setting the utility parameters for the printer	1-3
Selecting and positioning glassware.....	1-3
Correcting for cell variability.....	1-4
Z-dimensions	1-4

CHAPTER 2 - Using the Instrument

General information.....	2-1
Specifying names for tests	2-1
Specifying concentration units.....	2-1
Using the SmartStart feature	2-2
Running the cell correction program.....	2-2
Taking measurements	2-4
Scanning tests.....	2-5
Basic Absorbance/%T measurements.....	2-5
Setting the wavelength	2-6
Measuring a blank.....	2-6
Measuring unknowns.....	2-6
Basic Concentration measurements.....	2-6
Setting the wavelength & mode	2-6
Measuring a blank.....	2-6
Measuring a standard	2-6
Entering a factor	2-7
Measuring unknowns.....	2-7
Advanced A/%T/C - Absorbance & %Transmittance measurements	2-8
Recalling a test.....	2-8
Setting up test parameters	2-8
Taking measurements	2-9
Advanced A/%T/C - Concentration measurements.....	2-9
Recalling a test.....	2-9
Setting up test parameters	2-9
Measuring a standard.....	2-10
Entering a factor.....	2-10
Measuring unknowns.....	2-11
Standard Curve.....	2-11
Recalling a standard curve	2-11
Setting the parameters for a standard curve.....	2-11
Measuring the standards for a standard curve	2-12

Table of Contents

Measuring unknowns.....	2-13
Editing a standard curve.....	2-13
Absorbance Ratio.....	2-14
Recalling a test.....	2-15
Setting up test parameters.....	2-15
Measuring unknowns.....	2-15
Absorbance Difference.....	2-16
Recalling a test.....	2-16
Setting up test parameters.....	2-16
Measuring unknowns.....	2-16
Kinetics.....	2-17
Recalling a test.....	2-17
Setting up test parameters.....	2-17
Measuring unknowns.....	2-18
Rescaling & recalculating kinetics results.....	2-18
Rescaling & recalculating tabular kinetics results.....	2-19
Survey Scan/Scanning.....	2-20
Recalling a test.....	2-20
Setting up test parameters.....	2-20
Collecting a baseline scan.....	2-20
Scanning an unknown.....	2-21
Viewing & manipulating scan data.....	2-21
3-Point Net.....	2-23
Recalling a test.....	2-23
Setting up test parameters.....	2-24
Taking measurements.....	2-24
Multiple Wavelengths.....	2-24
Recalling a test.....	2-25
Setting up test parameters.....	2-25
Taking measurements.....	2-25

CHAPTER 3 - Using the Performance Validation Program

Overview.....	3-1
Accessing the Performance Validation tests.....	3-1
Troubleshooting checklist.....	3-1
Wavelength Accuracy - Internal.....	3-1
Wavelength Accuracy - Standards.....	3-2
Adding wavelengths.....	3-2
Deleting wavelengths.....	3-3
Photometric Accuracy.....	3-3
Selecting the mode.....	3-3
Adding standards.....	3-3
Deleting standards.....	3-4
Running the test.....	3-4
Noise Measurement.....	3-4
Stray Light.....	3-5
Running the test.....	3-5
Internal Printer Test.....	3-5

RS232C Test	3-6
Analog Output Test.....	3-6

CHAPTER 4 - Connecting & Using Accessories

General information.....	4-1
Cell holders & cell holder accessories	4-1
Changing cell holders	4-2
Internal printer.....	4-3
Installing the internal printer.....	4-3
Loading paper in the internal printer	4-3
External printers.....	4-3
External computers	4-3

CHAPTER 5 - Performing Maintenance Procedures

Routine care	5-1
Cleaning	5-1
Cleaning and maintenance of cells.....	5-1
Cleaning the windows of the sample compartment.....	5-2
Changing the fuse	5-2
Replacing the tungsten lamp.....	5-2
Replacement parts	5-3

Appendix A - Specifications

Appendix B - Parameters

Appendix C - Calculations

Index

Table of Contents

Setting Up the Instrument

Instrument description

The spectrophotometer, shown in Figure 1, is an easy-to-use, UV-Visible spectrophotometer designed for quantitative measurements in:

- Industrial quality control and research laboratories, including food and beverage, chemical and pharmaceutical applications
- Academic research and teaching laboratories
- Environmental laboratories, including water and wastewater applications
- Life science laboratories, for working on proteins and nucleic acid research

Your spectrophotometer offers:

- Unique optical system that ensures accuracy and precision
- Automatic wavelength calibration on power-up to ensure that the instrument is operating properly
- Built-in applications software for concentration, standard curve, absorbance ratio, absorbance difference, survey scanning, kinetics, multi-wavelength analysis and three-point net absorbance
- Built-in procedures that allow you to validate the performance of your instrument

Setting up the instrument

1. Carefully unpack the shipping carton and verify that you have received all the items listed below.
 - GENESYS 10 spectrophotometer
 - Power cord
 - Operator's Manual - GENESYS 10 spectrophotometer
 - Dust cover
2. Place the instrument on a flat, even surface that is:
 - As far as possible from any strong electric or magnetic fields and from any electrical device that may generate high-frequency fields
 - Free of dust, corrosive gases and strong vibrations

3. Remove any obstructions or materials that could hinder the flow of air under, behind and around the instrument.
4. Connect the female end of the power cord into the connector labeled **A/C power** on the back panel of the instrument (see Figure 2).
5. Plug the other end of the power cord into a grounded outlet with the appropriate voltage.
6. Ensure that the sample compartment does not contain any samples, and that the sample compartment door is closed.
7. Snap the paper roll holders (if needed) into place as shown in Figure 3. They will fit flush with the top of the instrument.
8. Turn on the instrument by pressing the power switch to ON (1=ON, 0=OFF). The power-on sequence will appear on the display and the instrument will go through its self-diagnostics. The instrument performs these diagnostics in the sequence shown:
 - a) Logo
 - b) Initializing
 - c) Calibrating filter wheel
 - d) Finding zero order
 - e) Finding energy peak
 - f) Calibrating grating
9. For the GENESYS 10 Vis unit only: When the power-on sequence is completed, allow the lamp to warm up for 30 minutes before taking any readings. The xenon lamp of the GENESYS 10 UV unit does not require a warm-up time.

Analog connections

The Survey Scan/Scanning and Kinetics tests can supply analog output to some models in the GENESYS 10 Series. Refer to the sections describing those tests for more information about setting up the scale parameters.

To connect an analog recorder, use the BNC connector supplied with your recorder. See Figure 2a for the location of the connector on the back panel of your instrument.

Setting Up the Instrument

Setting utility parameters

You should set up some of the utility parameters after the instrument is first powered up. These parameters include the date and time, standby setting, language, screen contrast settings and parameters needed to set up the printer.

You can set up the other utility parameters, or change the utility settings, at any time except when an entry screen is displayed or when the instrument is carrying out a task (such as setting the blank).

- Press the **UTILITY** key. The **Utility** screen appears on the display.

From this screen, you can set the date and time, select the standby settings, select the language, reset the lamp hours, select the contrast settings and select the parameters for a printer.

Selecting the language

The instrument supports English, Spanish, French, German and Italian as the language options.

- With the **Utility** screen displayed, press the arrow keys to highlight **Language** and press **ENTER**.
- Press the arrow keys to highlight the language you want to select and press **ENTER**.

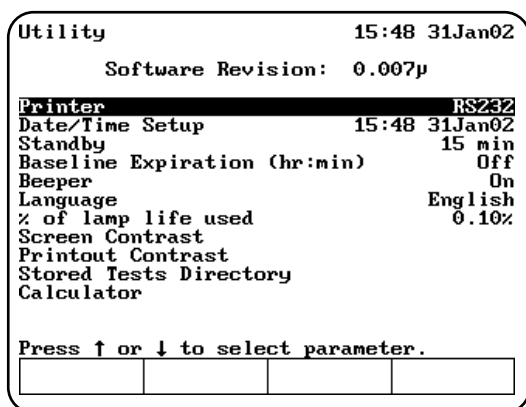

Setting the date and time

To access the date and time settings:

- With the **Utility** screen displayed, press the arrow keys to highlight **Date/Time Setup** and press **ENTER**. The screen displays the three date/time options that you can modify - date, time format and time.

To set the date:

- Press the arrow keys to highlight **Set Date** and press **ENTER**.
- Press **Set Day**, type the date, then press **ENTER**.
- Press **Set Month**, highlight the correct month, then press **ENTER**.
- Press **Set Year**, type the year, then press **ENTER**.
- When the date is correct, press **ESC** to save the settings and return to the **Utility** screen.

To select the time format:

You can set up the spectrophotometer to display the time in either am/pm format or in 24-hour format.

- To change the display format for the time, press the arrow keys to highlight **Time Format** and press **ENTER** until the format that you want to use (AM/PM or 24 hour) appears.

To set the time:

- Press the arrow keys to highlight **Set Time** and press **ENTER**.
- To set the hour, press **Set Hour**, type in the hour and press **ENTER**.
- To set the minutes, press **Set Minute**, type in the minute and press **ENTER**.
- To select between AM and PM, press **Set AM/PM** until the appropriate setting appears.

Note: Any changes you make are saved automatically (even during power down) by battery backup.

Selecting standby settings

To prolong xenon lamp life, your GENESYS spectrophotometer has been pre-set at the factory to automatically go into standby mode after 15 minutes. Since the tungsten lamp of the GENESYS Vis spectrophotometer requires a 30-minute warm-up, your GENESYS 10 Vis spectrophotometer has been pre-set at the factory to "Standby Mode OFF". To change Standby Mode time in either model:

- With the **Utility** screen displayed, press the arrow keys to highlight **Standby** and press **ENTER**.

- Press the arrow keys to highlight the length of time you want the instrument will wait before entering standby mode and press **ENTER**.

Setting baseline expiration time

If you will be performing scans on your samples, you can set a time limit for a collected baseline.

To set the baseline expiration time:

- With the **Utility** screen displayed, press the arrow keys to highlight **Baseline Expiration** (hr:min) and press **ENTER**.
- Enter the desired time into the Entry baseline expiration time field. Press **ENTER**.

Setting the screen contrast

To make it easier to read the display, you can adjust the screen contrast on the spectrophotometer.

- With the **Utility** screen displayed, press the arrow keys to highlight **Screen Contrast** and press **ENTER**.
- Press the arrow keys to adjust the screen contrast.
- When the screen contrast is correct, press **ESC**.

Setting up the internal printer

To set up the printer properly, you need to load the paper and set the utility parameters for the printer. Before setting up the parameters for the printer, be sure that the printer is installed. If you have ordered the internal printer as a separate item, you will need to install it. Refer to the section *Connecting & using accessories* for instructions on installing the printer.

Loading paper in the internal printer

Note: *Make sure that the paper roll holders are in place as shown in Figure 3. When installed correctly, they will fit flush with the top of the instrument.*

- Cut the paper so the edge is even.

Note: *Arrows on the paper roll holders indicate the direction of the paper feed (see Figure 3).*

- Feed the paper straight into the paper entry slot. The printer grabs the end of the paper and pulls it in.
- In Basic Absorbance/%Transmittance (%T), when the paper stops, press **ENTER** to

continue advancing the paper until the paper comes out of the paper exit slot.

- Pull out on the finger tabs on the paper roll holders and secure the roll of paper onto the paper roll holder.

Setting the utility parameters for the printer

If you wish to use a printer you can output to:

- Internal printer.
- External RS232 printer.
- Parallel port to an HP PCL formatted printer (only available on the GENESYS 10 UVscanning model only - catalog numbers 335906 and 335907).

To ensure that the spectrophotometer can output information correctly to the printer, you need to select the appropriate device.

- Press the **UTILITY** key. The **Utility** screen appears on the display.
- Press the arrow keys to highlight **Printer** and press **ENTER**.

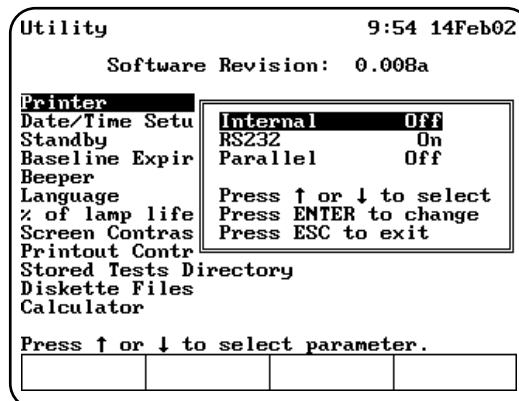

- Select the printer that you want to use and press **ENTER** until **On** appears.
- Press **ESC** to save the settings and return to the Utility screen.

Selecting and positioning glassware

The wavelength range for different types of cells varies depending on the manufacturer:

- Glass - From 320 to 360nm, up to 1100nm.
- Quartz - From 190 to 230nm, up to 1100nm.

Setting Up the Instrument

- Disposable - Refer to manufacturer's specifications and ensure that you work within the recommended range.

Test tubes vs. cuvettes

- Square cuvettes that are carefully matched (see "Correcting for cell variability" below) yield very precise results. Matched test tubes, when properly handled, can show as little as 1-2% deviation between readings.
- The pathlength of test tubes is not as well defined as in square cuvettes. However, constructing a standard curve eliminates the need for great accuracy in knowing the pathlength, provided that the same pathlength cell is used for all blanks, standards and samples.

Other guidelines

- Be sure to position cuvettes and test tubes so that the clear sides face the light beam. This means that one clear side should face the front of the instrument and the other clear side should face the back of the instrument.

Note: *Test tubes should always be placed in the instrument in exactly the same orientation in the light beam. A fiducial mark on the test tube helps you orient the test tubes consistently and correctly.*

- When using small aperture cells:
 - Always use masked cells.
 - Use the same cell (or cuvette) for your blank and your samples.

Correcting for cell variability

Due to variability in cell manufacture, each cell may have slightly different absorbance and reflection characteristics. Although it would be ideal to use exactly the same cell for every reading, it is usually inconvenient to clean cells between readings.

The GENESYS 10 UV*scanning* model uses an automated program to correct for cell variability, allowing you to use up to six unmatched cuvettes. Nearly any cell can be used with a high degree of accuracy if you have run the cell correction program on those cells.

Z-dimensions

The figure below illustrates the position of the light beam in the spectrophotometer.

The specifications for the sample compartment, including the dimensions of the beam are:

- Z-dimension
 - Square cuvettes/Test tubes 8.5mm
- Beam size 2mm (wide) x 7mm (high)

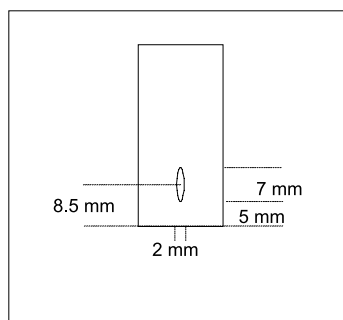

Using the Instrument

General information

Editing and Loading Saved Tests

When you save a test, it is stored in the Utility Test Directory. Within this directory, these tests can be loaded, deleted or locked/unlocked.

To load, delete or lock/unlock tests:

1. Press the **UTILITY** key on the keyboard. The **Utility** screen appears.
2. Using the arrow keys, highlight **Stored Tests Directory** and press **ENTER**. A list of all the stored tests appears.

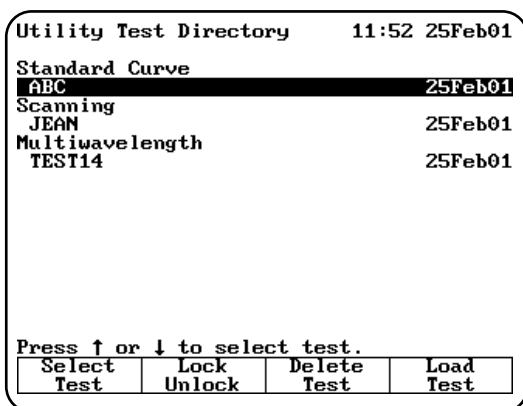

3. To load a test, use the arrow keys to highlight the name of the test you want to recall and press **ENTER**. The test will be loaded and the parameters for the selected test appear on the screen.
4. To lock or unlock a test, use the arrow keys to highlight the name of the test you want to lock or unlock and press **Lock/Unlock**. Enter the password (found on page iii of this manual) and press **ENTER**. The test is either locked or unlocked.
5. To delete a test, use the arrow keys to highlight the name of the test you want to delete. Press **ENTER**. The test is deleted.

Specifying names for tests

When you save tests, you need to specify the name you want to use for the file. The spectrophotometer does not have a full keypad, so you need to select the characters for the filename from a character list.

1. After setting up the values for the test parameters, press **Save Test**. The **Create Test Name** screen appears.

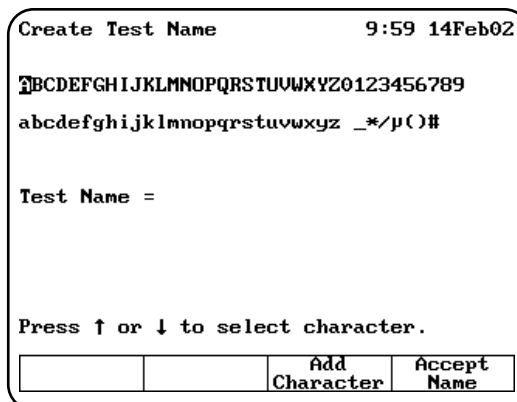

You can use this screen to:

- Delete the name of a test
 - Delete a character in the name of a test
 - Add a character to the name of a test
 - Accept the name of a test
2. Use the arrow keys to highlight the first character you want to use for the name of your test and press **Add Character** to add the selected character to the name.
 3. Continue selecting and adding characters until you have selected all the characters for the name.
 4. Press **Accept Name** to accept the name and return to the previous screen. The name of the test appears at the top of the screen showing the test parameters.

Specifying concentration units

When you run concentration tests, you need to specify the units you want to use when reporting concentrations. The spectrophotometer includes a set of basic concentration units and you can also enter custom units if you wish.

All programs in the spectrophotometer use the same list of basic units:

- Concentration
- ppm
- ppb
- g/L
- mg/L
- mg/mL
- µg/L
- M/L
- mM/L
- IU

In addition to these units, you can create your own custom unit, using a character list like the one described in **Specifying names for tests**. Once

Using the Instrument

you create a custom unit, it will appear in the list that you use to select the units.

To select the units

1. Highlight the **Units** parameter on the screen and press **ENTER**.
2. Use the arrow keys to highlight the unit you want to select and press **ENTER**.

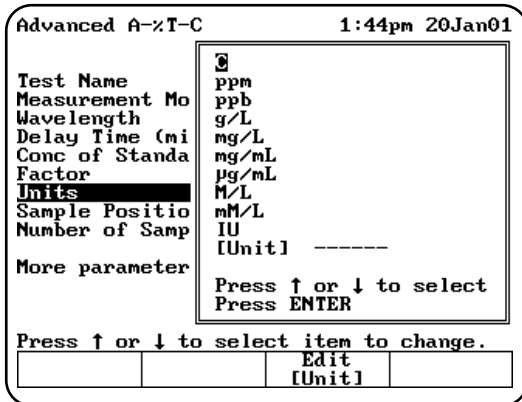

To create custom units

In addition to the basic concentration units, you can create one other custom concentration unit and add it to the list.

1. With the list of basic units displayed, use the arrow keys to highlight **[Unit]** and press **ENTER**.

OR

Press **Edit [Unit]** on a test set-up screen for a test with units.

The character list appears. You can use this screen to:

- Delete the name of a unit
- Delete a character in the name of a unit
- Add a character to the name of a unit
- Accept the name of a unit

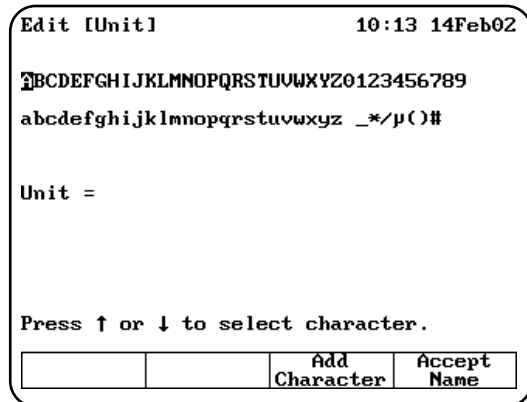

2. Use the arrow keys to highlight the first character you want to use for the name of your custom unit and press **Add Character** to add the selected character to the name.
3. Continue selecting and adding characters until you have selected all the characters for the name.
4. Press **Accept Name** to accept the name and return to the previous screen. The name of the new custom unit appears on the list of basic units.

Using the SmartStart feature

(GENESYS 10 UVscanning model only)

The SmartStart feature enables you to select the test methods you use most frequently and have them appear when you start up your instrument. If your laboratory runs only a single test, you can use the SmartStart feature to select it and it will appear each time you start up your instrument. Similarly, if you have a set of tests you run, you can use SmartStart to select them so the list appears when you start up the instrument.

Setting up a single-test SmartStart

1. Press the **UTILITY** key on the keypad to display the **Utility** screen.
2. Highlight the **Stored Tests Directory** and press **ENTER**. A list of all the tests on the instrument appears on the screen.
3. Scroll down through the list until the appropriate test is highlighted.
4. When the appropriate test is highlighted, press **Select Test** to add the selected test to the SmartStart menu. An arrow sign ">" will indicate the test has been selected

5. Press **Load Test**
6. The parameter screen of the test you selected will be displayed.

Note: *At this point, you can power down the instrument and then power it back up. When it starts up again, the parameter screen for the selected test will be displayed.*

Setting up a multiple-test SmartStart

1. Press the **UTILITY** key on the keypad to display the **Utility** screen.
2. Highlight the **Stored Tests Directory** and press **ENTER**. A list of all the tests on the instrument appears on the screen.
3. Scroll down through the list until the first appropriate test is highlighted.
4. Press **Select Tests** to add the selected test to the SmartStart menu.
5. Continue scrolling through the list and adding tests until you've made all the appropriate selections.
6. Press **ESC** until you return to the Tests screen.

Note: *At this point, you can power down the instrument and then power it back up. When it starts up again, the list of tests you've selected will be displayed.*

Running the cell correction program (GENESYS 10 UVscanning model only)

Note: *The Cell Correction program is not active in the Main (Basic Absorbance/%T/Basic Concentration) screen.*

Note: *The Cell Correction feature is active only when the 6-Position Sample Holder is set to either **Auto 6** or **Auto 3**. The feature is not active when the cell holder is set to **1-Cell Platform** or **Manual 6**, nor when the **Single Cell Holder** is installed.*

Every test setup screen provides access to the cell correction program. Before running the cell correction program:

- Clean the inside and outside of all the cells to be matched.
- Fill the cells with distilled water (or other blank solution), and place them in the

sample compartment (see "Selecting and positioning glassware" in the preceding section). Be sure to place the blank cuvette in Cell "B" of the sample compartment.

TIP: *If one cell has lower absorbance than the others, make it the blank.*

To run the Cell Correction program:

1. Press the **TEST** key on the keypad. When the **Test Types** screen appears, highlight the test you want to run and press **ENTER**.

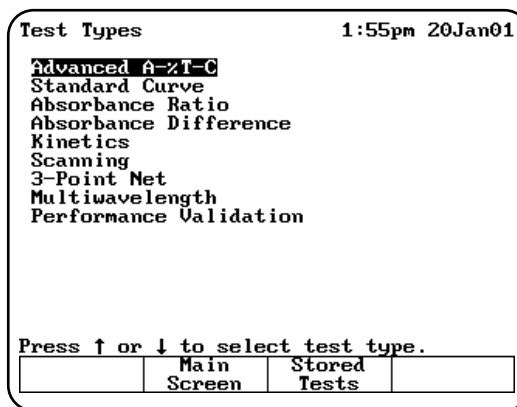

2. Highlight **Cell Correction** and press **ENTER**.

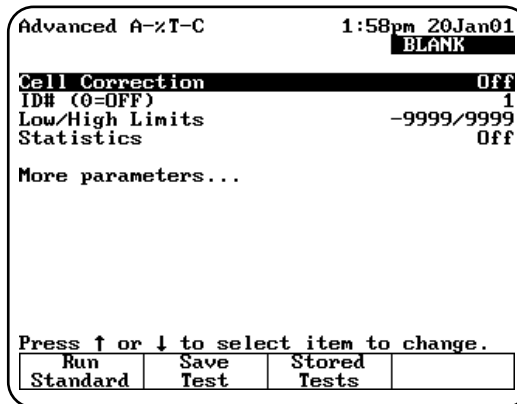

The Cell Correction function is now activated, as indicated by the word **On** across from **Cell Correction** on the test setup screen.

Using the Instrument

```

Advanced A-ZT-C          1:59pm 20Jan01
                        BLANK
Cell Correction          On
Setup Correction
ID# (0=OFF)             1
Low/High Limits         -9999/9999
Statistics               Off

More parameters...

Press ↑ or ↓ to select item to change.

```

	Save Test	Stored Tests	
--	-----------	--------------	--

Note: When Cell Correction is activated, additional parameter lines are added to the screen above the **Cell Correction** line. If the **Cell Correction** line is no longer visible on the screen, highlight **More parameters...** and press **ENTER**.

- Highlight **Set Up Correction** and press **ENTER**. The **Cell Correction** screen appears.
- Highlight **Correction Mode** and press **ENTER** to set the mode to either:
 - Scan** - Cell Correction is run on a blank and one sample cell for the range of wavelengths you specify in **Scanning** mode.
 - Discrete nms** - The Cell Correction program is run on a blank and up to five sample cells for up to 31 user-specified, discrete wavelengths.

```

Cell Correction          4:35am 21Jan01
                        BLANK
Correction Mode          Discrete nms
Date Corrected
Sample Positioner       Auto 6
Number of Matched Cuvettes 1

Press ↑ or ↓ to select item to change.

```

Set nms			Run Corr.
---------	--	--	-----------

- If you selected **Scan** mode in the preceding step, press **Run Corr.** to start the Cell Correction program. If you selected **Discrete nms** mode, first specify the wavelengths using

the procedures which follow, and then the Cell Correction program.

The Cell Correction program will measure the other cells against the blank and will record, store and date the measurements. From these measurements the Cell Correction program establishes the required correction factors, which then are automatically applied during all subsequent tests (if Cell Correction is activated).

Specifying wavelengths for Discrete nms mode:

- Highlight **Sample Positioner** and press **ENTER** to set this parameter to either **Auto 3** (when using three cell holders) or **Auto 6** (when using six cell holders).
- Highlight **Number of Matched Cuvettes** and press **ENTER**. Then use the keypad to specify the number of cells you are matching. Press **ENTER**.

```

Cell Correction          3:12pm 24Jan01
                        BLANK
Correction Mode          Discrete nms
Date Corrected
Sample Positioner       Auto 6
Number of Matched Cuvettes 1

Entry:
Enter Number of Samples (1 - 5)

```

--	--	--	--

- Press **Set nms** to select the wavelengths for which the Cell Correction program will be run. A list of wavelengths appears.

```

Cell Correction          15:33 26Jun02
                        BLANK

1      nm
2      600
3      540
4      450
4      ----

Entry: 405
Enter Wavelength (190 - 1100)

```

--	--	--	--

Note: *Cells should be matched at all analytical wavelengths because matching at one wavelength does not guarantee matching at others.*

4. Use the arrow keys to highlight the position where you want to enter the first wavelength.
5. Press **Add nm**.
6. Enter the value for the wavelength and press **ENTER**.
7. Continue until you have entered all the wavelengths.

After all the wavelengths have been entered, press **Run Corr.** to start the Cell Correction program. The Cell Correction program will measure the other cells against the blank and will record, store and date the measurements. From these measurements the Cell Correction program establishes the required correction factors, which then are automatically applied during all subsequent tests (if Cell Correction is activated).

Taking measurements

The spectrophotometer lets you use different cell holders and cell holder accessories to take measurements. When you set up your test parameters, you will select the type of measurement you want to use and indicate how many samples you have. You can choose from the following options:

- **Auto 6** - You can take one blank measurement and up to five sample measurements without changing the samples in the cell holder. The instrument automatically measures the blank (in the blank position), then automatically advances the cell holder to the appropriate position for the next measurement. This option is available only with the 6-Position Cell Holder.
- **Auto 3** - You can take up to three measurements without changing the samples in the cell holder. The instrument automatically measures the blank (in the blank position), then automatically advances the cell holder to the appropriate position for the next measurement. This option is available only with the 6-Position Cell Holder.
- **Single Cell Platform** - You place the blank in the cell holder, measure it, place a sample in the cell holder, then measure your sample. This process is completely manual. In fact, the

cell position buttons on the keypad do not function when you select Single Cell Platform even if you have a 6-Position Cell Holder installed in the sample compartment.

- **Manual 6** - You can take up to six measurements without changing the samples in the cell holder, using the cell position buttons on the keypad to advance the cell holder to the appropriate position for the next measurement. You place the blank in the blank position and your samples in the other cell positions. Regardless of where the cell holder is positioned, when you press Measure Blank the cell holder automatically goes to the blank position and measures the blank. However, you can use the cell position buttons to select a different position for the measurement. This option is available only with the 6-Position Cell Holder .

Note: *When you have the 6-Position Cell Holder installed, the instrument always considers the material in the B position as a blank. This means that even after measuring your blank the first time, you can place unknowns only in positions 1 through 5.*

The two automatic measurements (Auto 6 and Auto 3) are available only for instruments with the 6-Position Cell Holder. However, if you have one of these models, you can also choose to take measurements manually. Each test section later in this chapter includes specific instructions on how to take measurements automatically and manually.

Saving tests

When you power-down the instrument, the current test is maintained by battery back-up. This means that when you turn the instrument on again, the cell holder alignment and values for all parameters will be the same as they were when the instrument was last used. When you load a test that has been saved, the values for all parameters stored with that test will replace the current values for the test parameters.

As you create customized tests and collect data, you will be saving tests for later use. The spectrophotometer uses test files to contain the values for all the parameters needed to run a test, including the alignment of the cell holder and the other parameters for the accessories installed. Once you select the values for the parameters, you

Using the Instrument

can assign a test name and save the test. You can then restore the test and run it without having to set up the parameters again.

Basic Absorbance/%T measurements

The Absorbance/%Transmittance (%T) program takes measurements and displays them as either absorbance or %T. For each measurement taken, the absorbance (or %T) appear on the screen, along with the type of measurement, the date and time, the wavelength and the cell position used for the measurement. All the steps for taking measurements in the two modes are the same - the only difference will be the units used to display the results.

When you use the Basic Absorbance/%T program, you can perform these tasks:

- Set the wavelength
- Measure a blank
- Measure unknowns

If you want to work with %T instead of absorbance, simply press **Change Mode** until you see the %T mode. You can switch from one mode to another whenever you see the **Change Mode** function key.

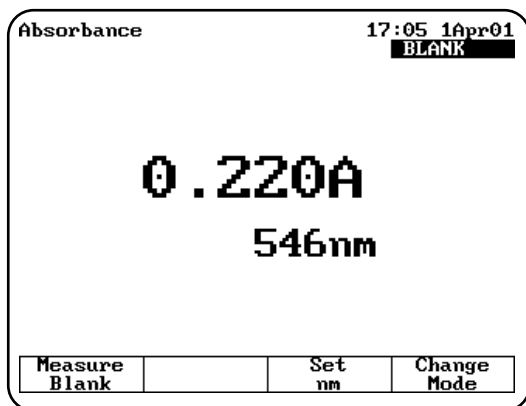

Setting the wavelength

1. Press **Set nm** or any number key to set the wavelength.

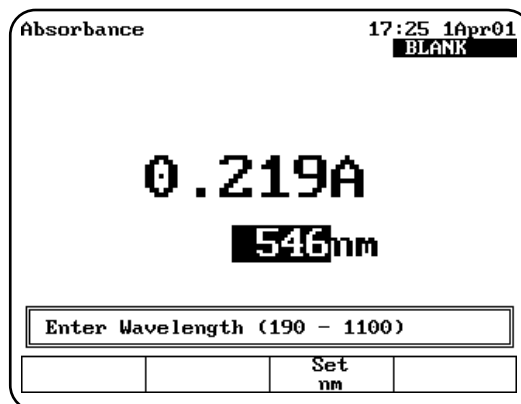

2. Enter the wavelength where you want the measurements taken, then press **Set nm** again.

Measuring a blank

1. Place the blank in the cell holder. If your instrument has a 6-Position Cell Holder, be sure to place the blank in the B position.
2. If you want to enter an absorbance or transmittance value for the blank, press a number key and enter the value in the **Entry** field.
3. Press **Measure Blank** to measure the blank. When the instrument is finished measuring the blank, the message disappears.

Measuring unknowns

1. If your instrument is equipped with the 6-Position Cell Holder, place the unknown you want to measure in one of the cell positions and press the corresponding cell position button on the keypad to move the cell holder to the measuring position. The absorbance (ABS) or %transmittance (%T) measurement appears on the display.

If your instrument is equipped with the Single Cell Holder Platform, remove the blank and place the unknown in the cell holder. The absorbance or %transmittance measurement appears on the display.

Basic Concentration measurements

Measuring concentration is similar to measuring absorbance or %T and you use the **Change Mode** function key to switch to concentration measurements. The spectrophotometer allows you to measure concentration using either a factor or a standard to convert absorbance readings to concentration units.

- When you use a factor, you need to specify the factor and the concentration units.
- When you use a standard, you need to specify the concentration of the standard and measure its absorbance.

When you use the Basic Concentration program, you can perform these tasks:

- Set the wavelength
- Measure a blank
- Measure a standard **OR** enter a factor
- Measure unknowns

The steps for taking measurements in the two modes are similar - the only difference will be whether you measure a standard or enter a factor.

Setting the wavelength & mode

1. Press **Set nm** or any number key to set the wavelength.
2. Enter the wavelength where you want the measurements taken, then press **Set nm** again.
3. Press **Change Mode** until the appropriate measurement mode (Concentration with Standard or Concentration with Factor) appears.

Measuring a blank

1. Place the blank in the cell holder. If your instrument has a 6-Position Cell Holder, be sure to place the blank in the B position.
2. If you want to enter a concentration for the blank, press a number key and enter the concentration in the **Entry** field.
3. Press **Measure Blank** to measure the blank. When the instrument is finished measuring the absorbance of the blank, the message disappears.

Measuring a standard

1. If necessary, press **Change Mode** to switch to the **Concentration with Standard** mode.

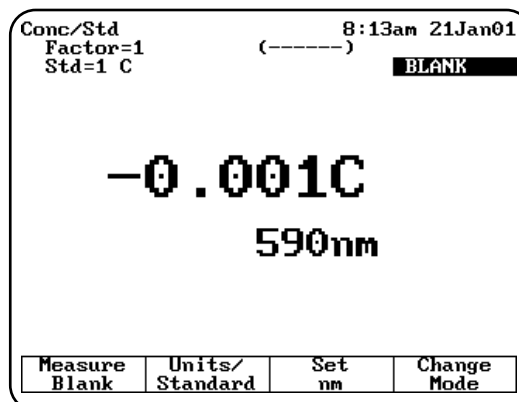

2. If your instrument is equipped with the 6-Position Cell Holder, place the standard in one of the cell positions and press the corresponding cell position key on the keypad. If your instrument is equipped with the Single Cell Holder Platform, remove the blank and place the standard in the cell holder.
3. Press **Units/Standard** to set the units and measure the standard.
4. **Enter Conc**, use the number keys to enter the concentration value of the standard and then press **ENTER**.
5. Press **Select Units**, use the arrow keys to highlight the entry in the **Units** field and then press **ENTER** to select the units for the concentration.

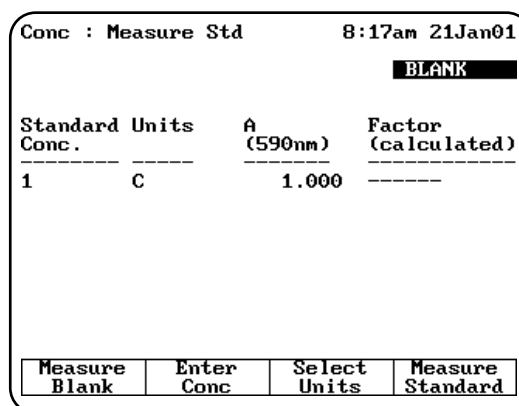

6. Press **Measure Standard** to measure the standard. When the instrument is finished measuring the absorbance of the standard, it displays the absorbance and calculated factor.

Using the Instrument

Entering a factor

1. If necessary, press **Change Mode** to switch to the **Concentration with Factor** mode.
2. Press **Units/Factor** to set the factor and select the units.

3. Use the arrow keys to highlight the entry in the **Factor** field and press **Enter Factor** to enter the factor.
4. Use the number keys to enter the factor.
5. Press **Enter Factor** to accept the factor and return to the screen displaying the factor and units. The factor you just entered appears on the display.

6. Press **ESC** to return to the **Concentration with Factor** screen.

Measuring unknowns

1. If your instrument is equipped with the 6-Position Cell Holder, place the unknown you want to measure in one of the cell positions and press the corresponding cell position

button on the keypad to move the cell holder to the measuring position. The measurement appears on the display.

If your instrument is equipped with the Single Cell Holder Platform, remove the blank and place the unknown in the cell holder. The measurement appears on the display.

Advanced A/%T/C - Absorbance & %Transmittance measurements

When you use the Advanced A/%T/C program for absorbance or %transmittance measurements, you can perform these tasks:

- Select the measurement mode you want to use (Absorbance or %Transmittance)
- Run Cell Correction program (GENESYS 10 UVscanning model only)
- Recall a test OR set up your test parameters
- Measure a blank
- Measure unknowns

To get started, press the **TEST** key on the keypad. When the **Test Types** screen appears, highlight **Advanced A/%T/C** and press **ENTER**.

Recalling a test

1. With the **Advanced A/%T/C** screen displayed, press **Stored Tests**. A list of stored tests appears.
2. Use the arrow keys to highlight the name of the test you want to recall and press **ENTER**. The parameters for the selected test appear on the screen.

From this screen, you can:

- Set up test parameters
- Run Cell Correction program (GENESYS 10 UVscanning model only)
- Save a test
- View the list of stored tests
- Measure a blank and unknowns

Setting up test parameters

1. With the **Advanced A/%T/C** screen displayed, use the arrow keys to highlight the name of the parameter you want to set.

Some parameters appear only if you select one of the concentration modes, while others appear regardless of the measurement mode you select. A complete list of the parameters are located in Appendix B.

2. When the parameters are set, you can press **Save Test** to save the test or **Measure Sample** to measure a blank or unknowns.

Taking measurements

Advanced A-%T-C		12:47 11Feb01
Test Name: ABCDE		Cell # 5
ID#	Abs 660nm	
1	0.129	
2	0.082	
3	0.247	
4	0.287	
5	0.140	

Page 1 of 2, Samples 1 - 5
Press ↑ or ↓ to view data

			Measure Samples
--	--	--	-----------------

Taking measurements automatically (using Auto 6 or Auto 3)

1. With the **Advanced A/%T/C** screen displayed and the parameters set, press **Run Sample**. The **Advanced A/%T/C** measurement screen appears.
2. Place the blank and the unknowns in the correct cell positions.
3. Press **Measure Sample** to measure the unknowns. The instrument automatically measures the blank first, then measures the

unknowns and displays the sample measurements on the screen.

Taking measurements manually (using Manual 6 or Single Cell Platform)

1. With the **Advanced A/%T/C** screen displayed and the parameters set, press **Measure Sample**. The **Advanced A/%T/C** measurement screen appears, prompting you to place your samples in the cell holder.
2. Place the blank and unknowns in the cell holder. If your instrument is equipped with a 6-Position Cell Holder, be sure to place the blank in the B position. You can place up to five samples in the cell holder.
3. Press **Measure Blank** to measure the blank. If your instrument is equipped with a 6-Position Cell Holder, it automatically moves to the B position to measure the blank. When it completes the measurement, it returns to its previous cell position.
4. Press **Measure Sample** to measure the unknowns. The sample measurement appears on the screen. If your instrument is equipped with a 6-Position Cell Holder, press the cell position buttons on the keypad to reposition the cell holder and measure the rest of the unknowns manually.

Advanced A/%T/C - Concentration measurements

When you use the Advanced A/%T/C program for concentration measurements, you can perform these tasks:

- Select the measurement mode you want to use (concentration with one standard or concentration with a factor)
- Recall a test **OR** set up your test parameters
- Measure a standard **OR** enter a factor (only if you select either concentration with one standard or concentration with a factor)
- Measure a blank and unknowns

To get started, press the **TEST** key on the keypad. When the **Test Types** screen appears, highlight **Advanced A/%T/C** and press **ENTER**.

Using the Instrument

```

Advanced A-%T-C          10:08am 21Jan01
                        BLANK
Test Name                AAA
Measurement Mode         Conc/Std
Wavelength               546nm
Delay Time (min:sec)    0:00
Conc of Standard        100
Factor                   877.1
Units                   -----
Sample Positioner       Manual 6
More parameters...

Press ↑ or ↓ to select item to change.
  Run   Save   Stored   Run
Standard Test   Tests   Test
  
```

```

Advanced A-%T-C          10:35 7Mar01
Test Name: -----
                        BLANK
Conc.   Abs   Factor
  C     660nm calculated
-----
Entry:
Enter a number (0.001 to 9999)
  
```

Recalling a test

1. With the **Advanced A/%T/C** screen displayed, press **Stored Tests**. A list of stored tests appears.
2. Use the arrow keys to highlight the name of the test you want to recall and press **ENTER**. The parameters for the selected test appear on the screen.

Setting up test parameters

1. With the **Advanced A/%T/C** screen displayed, use the arrow keys to highlight the name of the parameter you want to set.

Some parameters appear only if you select one of the concentration modes, while others appear regardless of the measurement mode you select. A complete list of the parameters are located in Appendix B.

2. When the parameters are set, you can press **Save Test** to save the test or **Run Test** or **Run Standard** to measure a standard.

Measuring a standard

Measuring a standard automatically (using Auto 6 or Auto 3)

1. With the **Advanced A/%T/C** screen displayed and the Measurement Mode set to **Conc/Std**, press **Run Standard**. The **Measure Standard** screen appears.

2. Use the number keys to enter the concentration value of the standard and press **ENTER**.
3. Press **Measure Standard**.
4. Place the blank and standard in the correct cell positions.
5. Press **ENTER** to measure the blank and the standard. The instrument automatically measures the blank first, then measures the unknowns and displays the absorbance and calculated factor.

Measuring a standard manually (using Manual 6 or Single Cell Platform)

```

Advanced A-%T-C          15:40 26Jun02
                        BLANK
Test Name                AAA
Measurement Mode         Conc/Std
Wavelength               546nm
Ref. Wavelength Correction Off
Delay Time (min:sec)    0:00
Conc of Standard        100.0
Factor                   1587
Units                   C
Sample Positioner       Auto 6
Number of Samples       4
More parameters...

Press ↑ or ↓ to select item to change.
  Run   Save   Stored   Run
Standard Test   Tests   Test
  
```

1. With the **Advanced A/%T/C** screen displayed and the Measurement Mode set to **Conc/Std**, press **Run Standard**. The **Measure Standard** screen appears.
2. Use the number keys to enter the concentration value of the standard and press **ENTER**.
3. Place the blank and standard in the correct cell positions.

4. Press **Measure Blank** to measure the blank. If your instrument is equipped with a 6-Position Cell Holder, it automatically moves to the B position to measure the blank. When it completes the measurement, it returns to its previous cell position.
5. Press **Measure Standard** to measure the standard. When the instrument is finished measuring the absorbance of the standard, it displays the absorbance and calculated factor.

Entering a factor

1. With the **Advanced A/%T/C** screen displayed and the **Measurement Mode** set to **Conc/Factor**, use the arrow keys to highlight **Factor**.
2. If you need to change the factor, use the number keys to enter the correct factor.
3. If you need to change the units, use the arrow keys to highlight **Units** and select the correct units.

Measuring unknowns

Measuring unknowns automatically (using Auto 6 or Auto 3)

1. With the **Advanced A/%T/C** screen displayed and the **Measurement Mode** set to **Conc/Std** or **Conc/Factor**, press **Run Test**. The **Advanced A/%T/C** measurement screen appears, prompting you to place your samples in the cell holder.
2. Place the blank and unknowns in the correct cell positions. Press **ENTER**. The instrument automatically measures the blank first, then measures the unknowns and displays the sample measurements on the screen.
3. Press **Measure Sample** to measure additional unknowns.

Measuring unknowns manually (using Manual 6 or Single Cell Platform)

1. With the **Advanced A/%T/C** screen displayed and the **Measurement Mode** set to **Conc/Std** or **Conc/Factor**, press **Run Test**. The **Advanced A/%T/C** measurement screen appears.
2. Place the blank and unknown in the correct cell position. If your instrument is equipped with a

6-Position Cell Holder, you can place up to five samples in the cell holder.

3. Press **Measure Blank** to measure the blank. If your instrument is equipped with a 6-Position Cell Holder, it automatically moves to the B position to measure the blank. When it completes the measurement, it returns to its previous cell position.
4. Press **Measure Sample** to start the measurement. If your instrument is equipped with a 6-Position Cell Holder, press the cell position buttons on the keypad to reposition the cell holder and measure the rest of the unknowns manually.

Standard Curve

When you use the Standard Curve program, you can perform these tasks:

- Recall a standard curve **OR** create a standard curve (set up the parameters and then measure the standards for the curve)
- Run the Cell Correction program (GENESYS 10 UVscanning model only)
- Measure unknowns
- View the data - select between graphical and tabular displays
- Edit a standard curve - change the number of standards, select a different curve fit or delete points from the curve

To get started, press the **TEST** key on the keypad. When the **Test Types** screen appears, highlight **Standard Curve** and press **ENTER**. The **Standard Curve** screen appears.

Standard Curve		8:34am 21Jan01	
		Cell # 2	
Test Name	-----		
Date Standards Measured			
Wavelength	546nm		
Ref. Wavelength Correction	Off		
Curve Fit	Linear		
Number of Standards	2		
Units	C		
Sample Positioner	Auto 6		
Number of Samples	1		
More parameters...			
Press ↑ or ↓ to select item to change.			
Run Standards	Save Test	Stored Tests	

Using the Instrument

Recalling a standard curve

1. Press **Stored Tests** to display a list of stored tests.
2. Highlight the standard curve you want to recall.
3. Press **ENTER** to load the selected standard curve.

Setting the parameters for a standard curve

1. Place the standards in the correct cell positions.
2. Set the parameters for measuring the standards. Refer to the list of parameters in Appendix B for a description of each.
 - Enter the Test Name, Wavelength, Reference Wavelength Correction and Reference Wavelength.
 - Select the Curve Fit, Units and Sample Positioner.
 - Set the Number of Standards and Number of Samples.
 - Enter the low and high limits.
 - Select the settings for the Statistics and AutoPrint functions.
 - Run the Cell Correction program (GENESYS 10 UVscanning model only)

Measuring the standards for a standard curve

Measuring standards automatically (using Auto 6 or Auto 3)

1. Place the blank and standards in the correct cell positions.
2. When all the parameters are correct, press **Run Standards** to set up and run the standards.

Standard Curve			10:39 7Mar01
Test Name: ABC			BLANK
Std #	Conc. mg/L	Abs 630nm	
1	50.00	-----	
2	75.00	-----	
3		-----	
4		-----	

Entry:			
Enter a number (0.001 to 9999)			

3. Enter the concentration value into the **Entry** concentration field and press **ENTER**. When you've entered all the concentration values, the **Standards** screen appears.
4. Press **Measure Standards** to measure the blank and standards. The instrument automatically measures the blank first, then measures the standards. When the instrument has measured all the standards, the **Standards** screen appears, showing the absorbance of each standard, along with the slope, intercept and correlation coefficient of the standard curve.

Measuring standards manually (using Manual 6 or Single Cell Platform)

1. Place the blank and standards in the correct cell positions.
2. When all the parameters are correct, press **Run Standards** to set up and run the standards.
3. Enter the concentration value into the **Entry** concentration field. Press **ENTER**
4. When you have entered all the concentration values, the **Standards** screen appears.

Standard Curve			10:40 7Mar01
Test Name: ABC			BLANK
Std #	Conc. mg/L	Abs 630nm	
1	50.00	-----	
2	75.00	-----	
3	100.0	-----	
4	150.0	-----	

Page 1, Standards 1 - 4			
	Save Test	Edit Standards	Measure Standards

5. Press **Measure Blank** to measure the blank. If your instrument is equipped with a 6-Position Cell Holder, it automatically moves to the B position to measure the blank. When it completes the measurement, it returns to its previous cell position.
6. Press **Measure Standards** to measure the standards. If your instrument is equipped with a 6-Position Cell Holder, press the cell position buttons on the keypad to re-position the cell

holder and measure the rest of the standards manually.

When the instrument has measured all the standards, the **Standards** screen appears, showing the absorbance of each standard, along with the slope, intercept and correlation coefficient of the standard curve.

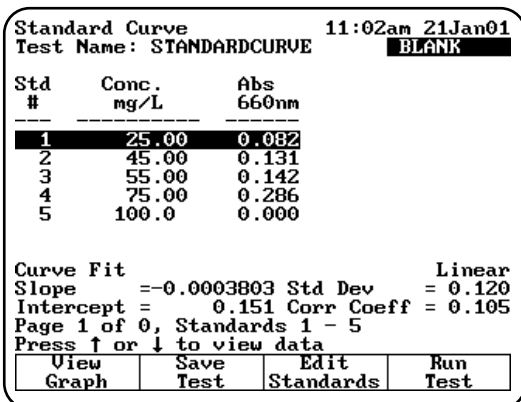

You can use this screen to:

- Edit the standards press (**Edit Standards**)
- Display a graph of the standard curve data (press **View Graph**)
- Save the standard curve (press **Save Test**)
- Measure your samples (press **Run Test**)

Measuring unknowns

Measuring unknowns automatically (using Auto 6 or Auto 3)

1. With the **Standards** screen displayed, press **Run Test**. The **Samples** screen appears.
2. Place the blank and unknowns in the correct cell positions.
3. Press **ENTER** to measure. The instrument automatically measures the blank first, then measures the unknowns. When the instrument has measured all the unknowns, the **Standard Curve** screen appears, showing the absorbance and concentration of each unknown.

If you want to switch between tabular and graphical displays, press **View Graph/Tabular**.

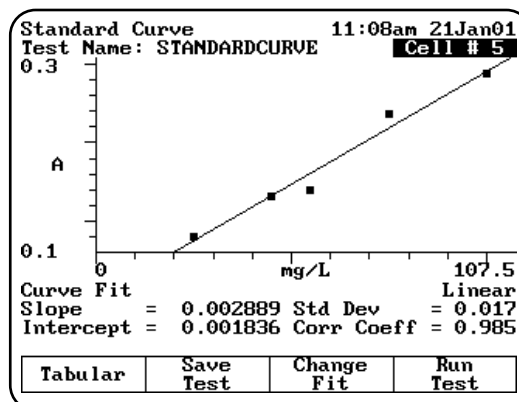

Measuring unknowns manually (using Manual 6 or Single Cell Platform)

1. With the Standards screen displayed, press **Run Test**. The **Samples** screen appears.
2. Place the blank and unknowns in the correct cell positions.
3. Press **Measure Blank** to measure the blank. If your instrument is equipped with a 6-Position Cell Holder, it automatically moves to the B position to measure the blank. When it completes the measurement, it returns to its previous cell position.
4. Press **Measure Samples** to measure the unknowns. If your instrument is equipped with a 6-Position Cell Holder, press the cell position buttons on the keypad to re-position the cell holder and measure the rest of the unknowns manually. When the instrument has measured all the unknowns, the Standards screen appears, showing the absorbance and concentration of each unknown.

Editing a standard curve

You may edit the concentration of any standard on a standard curve. In addition, you may change the number of standards, select a different curve fit or delete points from the curve.

Using the Instrument

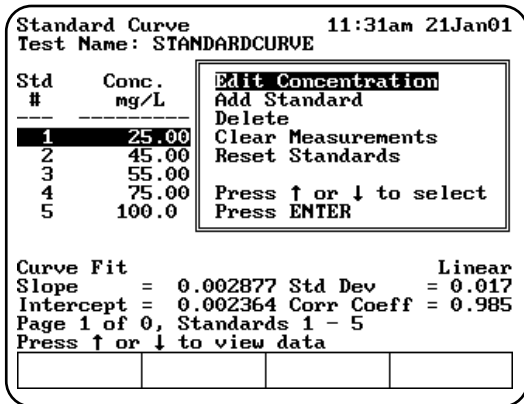

To edit the concentration of a standard

1. With the standard curve displayed on your screen, use the arrow keys to highlight the standard you want to edit. Press **Edit Standards**.
2. With the **Edit Concentration** highlighted, Press **ENTER**.
3. Press **Edit Conc** or a number key.
4. Enter the concentration value in the **Entry** field.
5. When the concentration value is correct, press **ENTER** to accept the value.

To add a standard

1. With the standard curve displayed on your screen, press **Edit Standards**.
2. Use the arrow keys to highlight **Add Standard**.
3. Enter the concentration value of the additional standard in the **Entry** field.
4. When the concentration value is correct, press **ENTER** to accept the value.
5. Press **Measure Standards** to remeasure all the standards.

To delete a standard

1. With the standard curve displayed on your screen, use the arrow keys to highlight the standard you want to delete. Press **Edit Standards**.
2. Use the arrow keys to highlight **Delete Standard**. Press **ENTER** to delete the standard.

To clear measurements

1. With the standard curve displayed on your screen, press **Edit Standards**.
2. Use the arrow keys to highlight **Clear Measurements** and press **ENTER**. All the absorbance measurements will be removed from the screen.

To reset standards

1. With the standard curve displayed on your screen, press **Reset Standards** and press **ENTER**.
2. Use the arrow keys to highlight **Reset Standards** and press **ENTER**. All the standards and measurements will be removed.

To select a different curve fit for a standard curve

Note: To change the curve fit for a standard curve, you must display the standard curve as a graph, not as a table.

1. With the standard curve you want to edit displayed as a graph on your screen, press **Change Fit**.

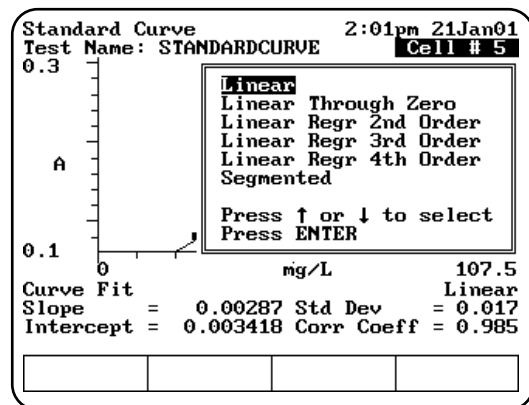

- Use the arrow keys to highlight the curve fit you want to use for the standard curve and press **ENTER**. The instrument applies the selected curve fit to the data and displays the new graph.

Absorbance Ratio

When you use the Absorbance Ratio program, you can perform these tasks:

- Recall a test **OR** set up your test parameters
- Run the Cell Correction program (GENESYS 10 UVscanning model only)
- Measure a blank
- Measure unknowns

To get started, press the **TEST** key on the keypad. When the **Test Types** screen appears, highlight **Absorbance Ratio** and press **ENTER**.

Recalling a test

Absorbance Ratio		2:04pm 21Jan01	
Test Name		Cell # 5	
Wavelength 1	546nm		
Wavelength 2	546nm		
Ref. Wavelength Correction	Off		
Sample Positioner	Auto 6		
Number of Samples	1		
More parameters...			
Press ↑ or ↓ to select item to change.			
	Save Test	Stored Tests	Run Test

- With the **Absorbance Ratio** screen displayed, press **Stored Tests**. A list of stored tests appears.
- Use the arrow keys to highlight the name of the test you want to recall and press **ENTER**. The parameters for the selected test appear on the screen.

From this screen, you can:

- Set up test parameters
- Run the Cell Correction program (GENESYS 10 UVscanning model only)
- Save a test
- View the list of stored tests

- Measure a blank
- Measure unknowns

Setting up test parameters

- With the **Absorbance Ratio** screen displayed, use the arrow keys to highlight the name of the parameter you want to set.
- When the parameters are set, you can press **Save Test** to save the test or **Run Test** to measure a blank or unknowns.

Measuring unknowns

Measuring unknowns automatically (using Auto 6 or Auto 3)

Absorbance Ratio		10:45 7Mar01	
Test Name: -----		BLANK	
ID#	Abs 260nm	Abs 280nm	Abs Ref.WL Result
Insert samples 1 - 4 into positions 1 - 4 Press ENTER to measure			

- Place the blank and unknowns in the correct cell positions.
- Press **ENTER** to start the measurement. The instrument automatically measures the blank first, then measures the unknowns and displays the sample measurements on the screen.

Measuring unknowns manually (using Manual 6 or Single Cell Platform)

- With the **Absorbance Ratio** screen displayed, press **Run Test**.

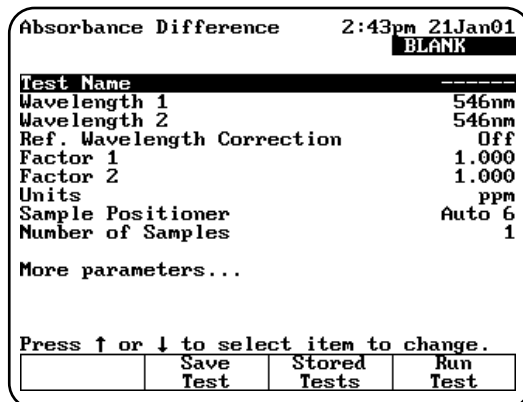
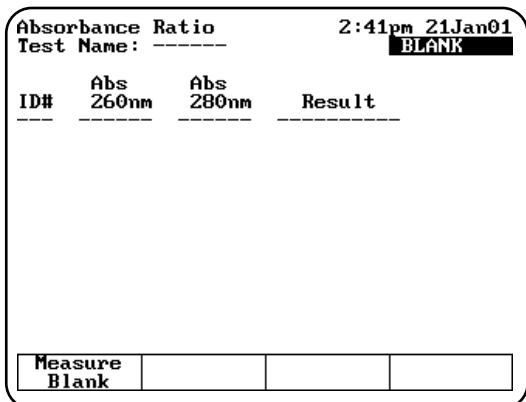

2. Place the blank and unknown in the correct cell position. If your instrument is equipped with a 6-Position Cell Holder, you can place up to five samples in the cell holder.
3. Press **Measure Blank** to measure the blank. If your instrument is equipped with a 6-Position Cell Holder, it automatically moves to the B position to measure the blank. When it completes the measurement, it returns to its previous cell position.
4. Press **Measure Sample** to start the measurement. If your instrument is equipped with a 6-Position Cell Holder, press the cell position buttons on the keypad to re-position the cell holder and measure the rest of the unknowns manually.

Absorbance Difference

When you use the Absorbance Difference program, you can perform these tasks:

- Recall a test **OR** set up your test parameters
- Run the Cell Correction program (GENESYS 10 UVscanning model only)
- Measure a blank
- Measure unknowns

To get started, press the **TEST** key on the keypad. When the **Test Types** screen appears, highlight **Absorbance Difference** and press **ENTER**.

Recalling a test

1. With the **Absorbance Difference** screen displayed, press **Stored Tests**. A list of stored tests appears.
2. Use the arrow keys to highlight the name of the test you want to recall and press **ENTER**. The parameters for the selected test appear on the screen.

From this screen, you can:

- Set up test parameters
- Set up Cell Correction program (GENESYS 10 UVscanning model only)
- Save a test
- View the list of stored tests
- Measure a blank
- Measure unknowns

Setting up test parameters

1. With the **Absorbance Difference** screen displayed, use the arrow keys to highlight the name of the parameter you want to set.
2. When the parameters are set, you can press **Save Test** to save the test or **Run Test** to measure a blank or unknowns.

Measuring unknowns

Measuring unknowns automatically (using Auto 6 or Auto 3)

1. With the **Absorbance Difference** screen displayed, press **Run Test**.
2. Place the blank and unknowns in the correct cell positions.
3. Press **ENTER** to start the measurement. The

instrument automatically measures the blank first, then measures the unknowns and displays the sample measurements on the screen.

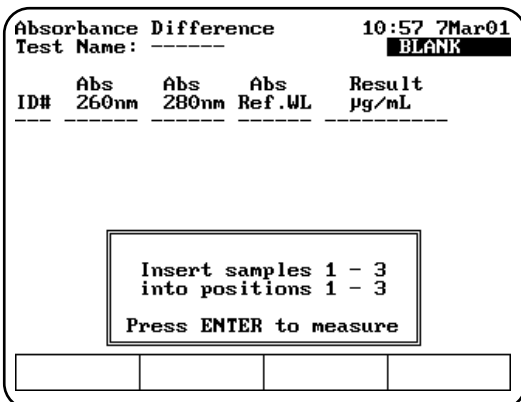

Measuring unknowns manually (using Manual 6 or Single Cell Platform)

1. With the **Absorbance Difference** screen displayed, press **Run Test**.
2. Place the blank and unknown in the correct cell position. If your instrument is equipped with a 6-Position Cell Holder, you can place up to five samples in the cell holder.
3. Press **Measure Blank** to measure the blank. If your instrument is equipped with a 6-Position Cell Holder, it automatically moves to the B position to measure the blank. When it completes the measurement, it returns to its previous cell position.

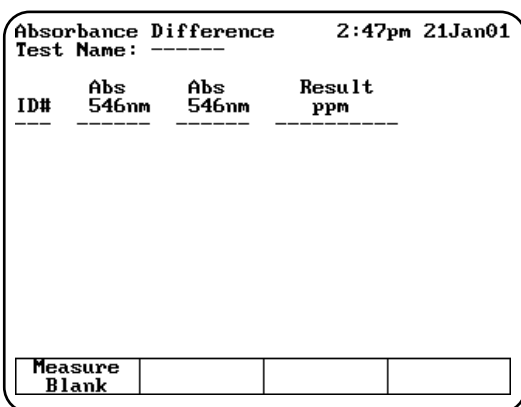

4. Press **Measure Sample** to start the measurement. If your instrument is equipped with a 6-Position Cell Holder, press the cell

position buttons on the keypad to re-position the cell holder and measure the rest of the unknowns manually.

Kinetics

When you use the Kinetics program, you can perform these tasks:

- Recall a test **OR** set up your test parameters
- Run the Cell Correction program (GENESYS 10 UVscanning model only)
- Measure a blank
- Measure an unknown
- Recalculate reaction rates
- Modify the scale of the plot

When you use the Kinetics program, you can choose to work with either graphical data or with tabular data. You can perform the same functions regardless of the type of display you select. However, the location of function keys varies depending on the type of display you choose.

Note: The Kinetics program allows you to measure only one unknown at a time.

Note: The Kinetics program allows you to collect up to 400 data points per run. When you set up your test parameters, be sure to select the interval time and total run time accordingly.

To get started, press the **TEST** key on the keypad. When the **Test Types** screen appears, highlight **Kinetics** and press **ENTER**.

Recalling a test

1. With the **Kinetics** screen displayed, press **Stored Tests**. A list of stored tests appears.
2. Use the arrow keys to highlight the name of the test you want to recall and press **ENTER**. The parameters for the selected test appear on the screen.

Using the Instrument

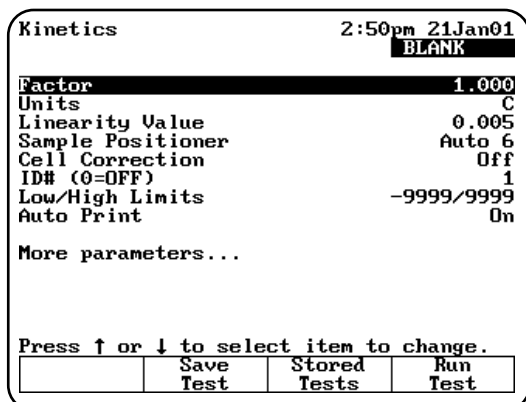

From this screen, you can:

- Set up test parameters
- Run the Cell Correction program (GENESYS 10 UVscanning model only)
- Save a test
- View the list of stored tests
- Measure a blank
- Measure unknowns
- Set up your analog recorder

Setting up test parameters

1. With the Kinetics screen displayed, use the arrow keys to highlight the name of the parameter you want to set.
2. When the parameters are set, you can press **Save Test** to save the test or **Run Test** to measure a blank or an unknown.

Measuring unknowns

Note: *If your instrument is equipped with a 6-position cell holder, be sure to place the blank in position B and the unknown in cell position #1. The instrument always uses cell position #1 to scan the unknown.*

1. With the **Kinetics** test parameters displayed on the screen, press **Run Test**.
2. If you have a 6-position cell holder, place the blank in position B and the unknown in position #1. Press **Measure Sample** to measure the blank and the unknown. When the instrument completes the measurement, the kinetics data and rate appear on the screen.

3. If you have 1-position cell holder, press **Measure Blank** to measure the blank, then insert your unknown and press **Measure Sample**. When the instrument completes the measurement, the kinetics data and rate appear on the screen.

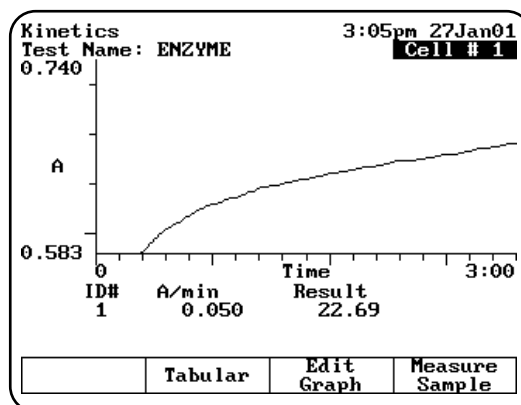

If you want to switch between tabular and graphical displays, press **Graph/Tabular**.

When you have a graphical display, you can press **Edit Graph**, then press **Cursor** to move the cursor line from one position to another on the plot. As the cursor moves the rate and result values indicate the values for the point on the plot where the cursor is located.

Rescaling & recalculating graphical kinetics results

Within the Kinetics program, you can view and manipulate your results either in graphical form or in tabular form. When your results are displayed on the screen, you can modify the range (start and stop time) and the instrument automatically recalculates the reaction rate.

When you are working with graphical kinetics results, you need to press **Edit Graph** before you can rescale and recalculate.

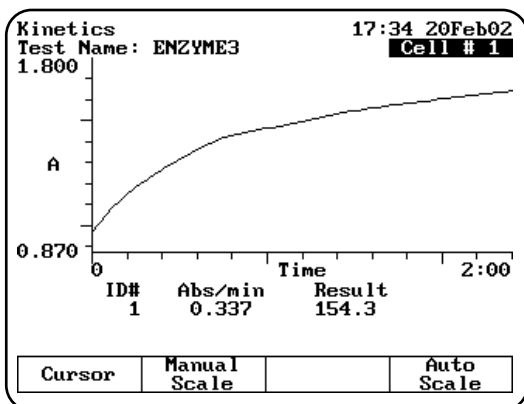

You can modify the scale of your kinetics data plot in two ways - automatically or manually. When you select Auto Scale, the instrument automatically scales the X- and Y-axes so all the data appears on the plot. When you select Manual Scale, you select specific minimum and maximum values for the X- and Y-axes. Whenever you modify the scale, the instrument also automatically recalculates and displays the new reaction rate and result.

When the edit screen appears, you can:

- Use the Auto Scale function to change the scale, display the new graph and recalculate the results
- Use the Manual Scale function to change the scale, display the new graph and recalculate the results
- Use the cursor to select new minimum or maximum values for the X-axis and recalculate the results.

To use the Auto Scale function

1. With your kinetics data displayed on the **Edit Graph** screen, press **Auto Scale**. The instrument automatically adjusts the minimum and maximum values for the X- and Y-axes so all the data appears on the plot. The instrument also recalculates the results, using all the data, and displays it on the screen.

To use the Manual Scale function

1. With your kinetics data displayed on the edit screen, press **Manual Scale**. The manual scale options appear.

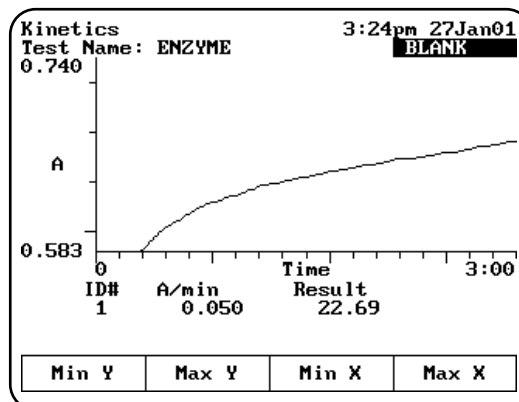

2. Use the number keys to enter the appropriate minimum or maximum value for the X- or Y-axis, then press the appropriate function key (**Min Y**, **Max Y**, **Min X**, **Max X**) to accept it. The instrument redraws the plot using the minimum and maximum value you have entered and displays the recalculated rate and result.
3. Continue until you have entered all the values you want to change.

To use the cursor

1. With your kinetics data displayed on the edit screen, press **Cursor**. The cursor options appear.

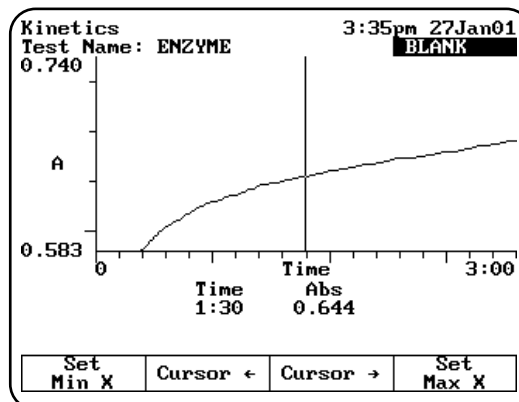

2. Press **Cursor ←** or **Cursor →** to position the cursor line on the appropriate point on the graph. The instrument displays the data for the selected point.

Using the Instrument

- When the cursor line is in the correct position, press **Set Min X** or **Set Max X** to accept the selected point. The instrument redraws the plot using the minimum and maximum value you have selected and displays the recalculated rate and result.

Rescaling & recalculating tabular kinetics results

When you are working with tabular kinetics results, you need to press **Edit Data** before you can rescale and recalculate.

After collecting your kinetics data, you can use all the data for the rate calculation or you can select specific start and end times. Whenever you modify the start and end times or select all the data, the instrument automatically recalculates and displays the new reaction rate and result.

When the edit screen appears, you can:

- Use all the data to recalculate the results
- Select specific start and end times for the rate calculation and recalculate the results.

Kinetics		12:57 30Jan01	
Test Name: KINETICS		Cell # 1	
HH:MM:SS	Abs	Delta	Lin
→ 0:00	0.417	---	---
0:10	0.471	0.054	---
0:20	0.510	0.039	L
0:30	0.534	0.024	L
0:40	0.550	0.016	L
0:50	0.559	0.010	L
1:00	0.568	0.008	L
1:10	0.574	0.007	L

ID#	min/Abs	Result
1	0.000	0.013

Press ↑ or ↓ for more data...

Use all data	Graph	Start Time	End Time
--------------	-------	------------	----------

To use all the data to calculate the reaction rate

- With your table of kinetics data displayed on the edit screen, press **Use all data**. The instrument calculates the rate and displays it on the screen.

To select specific start and end times for the rate calculation

- With your table of kinetics data displayed on the edit screen, use the arrow keys on the keypad to move the highlight symbol (→) to the appropriate data point in the table.
- Press **Start Time** or **End Time**. The instrument displays the recalculated rate and result.

Survey Scan/Scanning

The Survey Scan/Scanning program allows you to scan a wavelength range. The GENESYS 10 UVscanning model supports full range scanning (190-1100nm); GENESYS 10 Vis and UV models can scan a range of up to 100nm only. When you use the Survey Scan or Scanning programs, you can perform these tasks:

- Recall a test **OR** set up your test parameters
- Run the Cell Correction program (GENESYS 10 UVscanning model only)
- Collect a baseline scan
- Scan an unknown
- View scan data
- Change the scale of the data plot
- Determine 3-point net measurements
- Calculate the area under a curve
- Label peaks and valleys

Note: The Survey Scan/Scanning program allows you to measure only one unknown at a time. Auto 6, Auto 3 and Manual 6 are not available for scanned measurements.

Note: If you want to set a baseline expiration time, press **UTILITIES**, then use the arrow keys to highlight **Baseline Expiration**. Press **ENTER** and set the desired time.

To get started, press the **TEST** key on the keypad. When the **Test Types** screen appears, highlight **Survey Scan** or **Scanning** and press **ENTER**.

Recalling a test

- With the **Survey Scan/Scanning** screen displayed, press **Stored Tests**. A list of stored tests appears.
- Use the arrow keys to highlight the name of the test you want to recall and press **ENTER**. The parameters for the selected test appear on the screen.

From this screen, you can:

- Set up test parameters

- Set up Cell Correction program (GENESYS 10 UVscanning model only)
- Save a test
- View the list of stored tests
- Collect a baseline
- Scan unknowns

Setting up test parameters

1. With the **Survey Scan/Scanning** screen displayed, use the arrow keys to highlight the name of the parameter you want to set.
2. When the parameters are set, you can press **Save Test** to save the test or **Run Test** to measure a blank or an unknown.

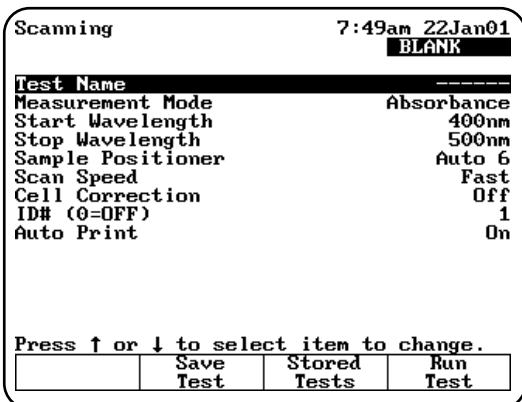

Collecting a baseline scan

Note: If your instrument is equipped with a 6-Position Cell Holder, be sure to place the blank in the B position. The instrument always uses the B position to collect the baseline.

1. With the **Survey Scan/Scanning** test parameters displayed, press **Run Test**.
2. Place the blank in the B position.
3. Press **Measure Blank** to collect the baseline. When the instrument is finished measuring the blank, the message disappears.

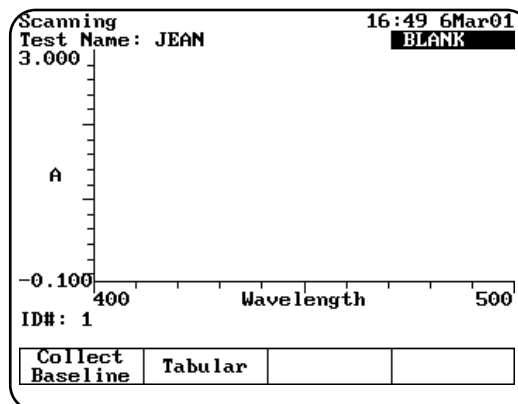

Note: If you want to switch between tabular and graphical displays, press **Graph/Tabular**.

Scanning an unknown

Note: If your instrument is equipped with a 6-Position Cell Holder, be sure to place the unknown in cell position #1. The instrument always uses cell position #1 to scan the unknown.

1. With the Survey Scan test parameters displayed on the screen, press **Run Test**.
2. If your instrument is equipped with a 6-Position Cell Holder, be sure to place the unknown in cell position #1.
3. Press **Measure Sample** to measure the unknown.

Note: If you want to switch between tabular and graphical displays, press **Graph/Tabular**.

Note: You may need to use the up and down arrow keys to view all the data for the scan.

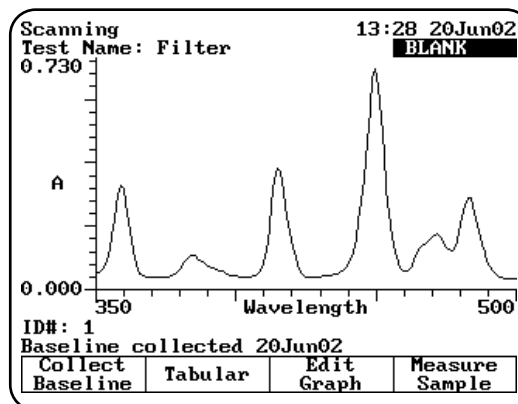

Using the Instrument

Viewing & manipulating scan data

Within the Survey Scan/Scanning program, you can view and manipulate your results either in graphical form or in tabular form.

When you are working with graphical scan data, you need to press **Edit Graph** before you can perform other functions on the scan data.

When the edit graph screen appears, you can:

- Rescale the graph
- Perform mathematical operations on the graph

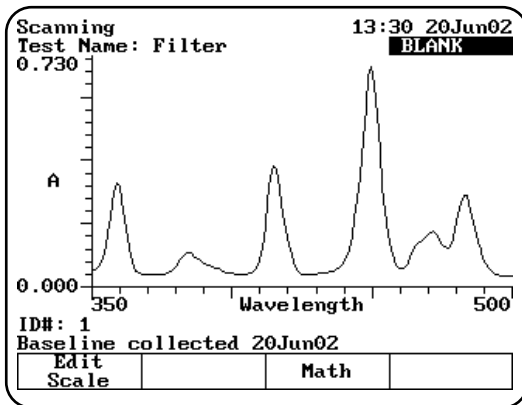

Rescaling graphical scan data

You can modify the scale of your scan data plot in two ways - automatically or manually. When you select Auto Scale, the instrument automatically scales the X- and Y-axes so all the data appears on the plot. When you select Manual Scale, you select specific minimum and maximum values for the X- and Y-axes. Whenever you modify the scale, the instrument also automatically recalculates and displays the new data plot.

Press **Edit Scale** to modify the scale. When the edit scale screen appears, you can:

- Use the cursor to identify specific points along the X-axis, change the scale and display the new graph
- Use the Manual Scale function to change the scale and display the new graph
- Use the Auto Scale function to change the scale and display the new graph

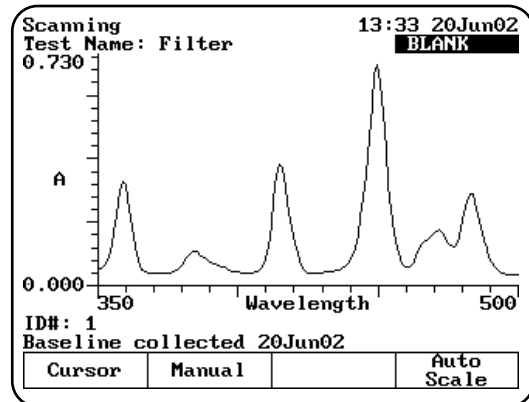

To use the cursor

1. With your scan data displayed on the edit scale screen, press **Cursor**. The cursor option appears

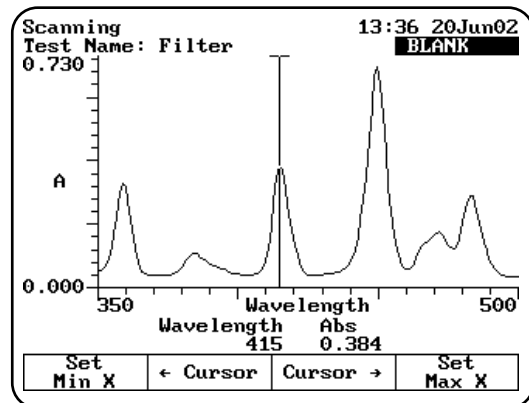

2. Press **Cursor →** or **Cursor ←** to position the cursor line on the appropriate point on the graph. The instrument displays the data for the selected point.
3. When the cursor line is in the correct position, press **Set Min X** or **Set Max X** to accept the selected point. The instrument redraws the plot using the minimum and maximum value you have selected and displays the new graph.

To use the Manual Scale function

1. With your scan data displayed on the edit scale screen, press **Manual**. The manual scale options appear.

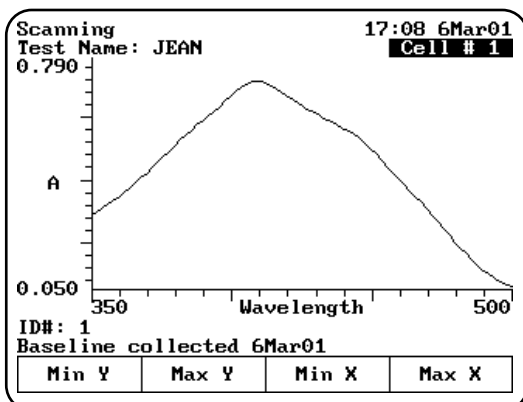

- To set the minimum or maximum value for the X- or Y-axis, press **Min Y**, **Max Y**, **Min X** or **Max X**. A screen appears prompting you to enter the appropriate value.
- Use the number keys to enter the correct value, then press the appropriate function key (**Min Y**, **Max Y**, **Min X**, **Max X**) to accept it. The instrument redraws the plot using the minimum and maximum values you have entered.

To use the Auto Scale function

- With your scan data displayed on the edit scale screen, press **Auto Scale**. The instrument automatically adjusts the minimum and maximum values for the X- and Y-axes so all the data appears on the plot.

Performing calculations on the scan data

You can modify your graph by performing calculations on the data. From the **Edit Graph** screen press **Math**. When the Math screen appears, you can:

- Determine 3-point net values
- Calculate the area under a curve
- Label peaks and valleys

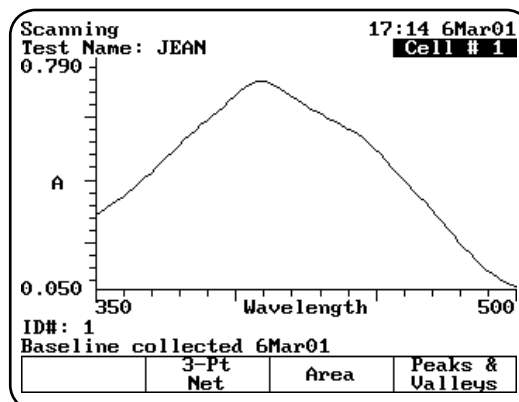

Determining 3-point net measurements

- With your scan data displayed on the edit graph screen, press **Math**. The **Math Calculation** screen appears.
- Press **3-Pt Net** to enter the **3-point Net Measurement** screen. A screen showing the cursor options and three cursor lines (designated for the left, center and right wavelengths) appears.

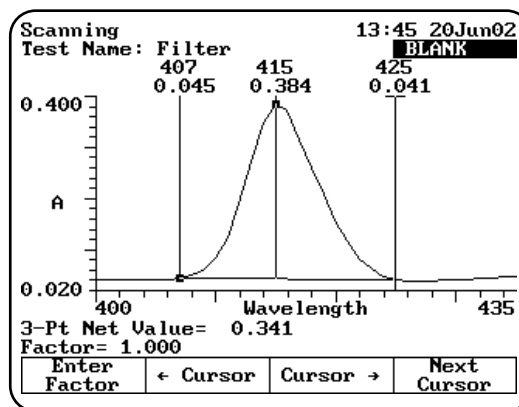

- Use **Cursor →** and **Cursor ←** to position the left cursor line to the desired wavelength value. The instrument calculates the 3-point net absorbance for the selected wavelengths.
- Continue selecting the other wavelengths by pressing **Next Cursor** to activate the center and right cursor lines. Select the wavelengths by positioning the cursor with the **Cursor ←** and **Cursor →** keys. Repeat until all three wavelengths have been selected.
- Press **Enter Factor** to access the set factor box. Enter the desired factor and press **ENTER**. The instrument calculates the value

Using the Instrument

for the 3-point net absorbance for the selected wavelengths, multiplied by the selected factor.

Calculating the area under a curve

1. With your scan data displayed on the **Edit Graph** screen, press **Math**. The **Math Calculation** screen appears.
2. Press **Area**. The **Area Under the Curve Measurement** screen appears.

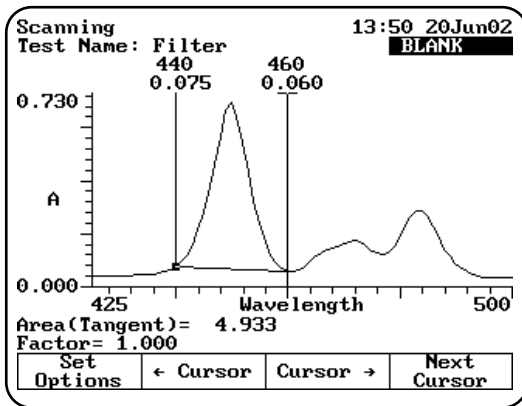

3. Use **Cursor** → and **Cursor** ← to position the left cursor line to the desired wavelength value. The instrument calculates the area under the curve for the selected wavelengths.
4. Continue selecting the other wavelengths by pressing **Next Cursor** to activate the next cursor line. Select the wavelength by positioning the cursor with the **Cursor** → and **Cursor** ← keys.
5. Press **Set Options** to access the **set options** window.
6. Use the up and down arrows to highlight **Factor**. Enter the desired factor and press **ENTER**.
7. Use the up and down arrow to highlight **Calculation baseline**. Press **ENTER** to toggle between **Zero** and **Tangent**.
8. Press **ESC** to return to the area under a curve screen. The instrument calculates the area under a curve for the selected wavelengths, factor and calculation method.

Labeling peaks and valleys

1. With your scan displayed on the edit graph screen, press **Math**. The **Math Calculation** screen appears.

2. Press **Peaks & Valleys**. The **Label Peaks and Valleys** window appears.

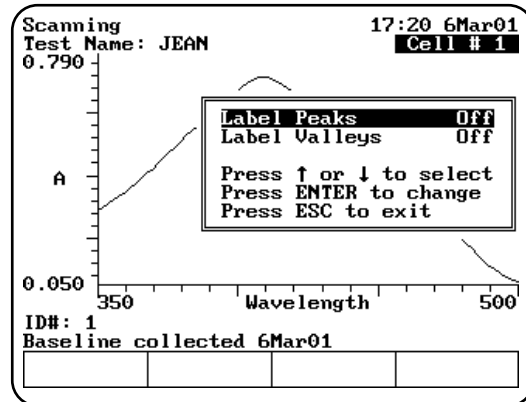

3. Use the arrow keys to select the type of labels you want displayed and press **ENTER**. The instrument labels the selected items on your scan data plot.

Note: Up to nine peaks or valleys can be calculated and displayed.

Viewing & rescaling tabular scan data

When you are working with tabular scan data, you need to press **Edit Data** before you can perform other functions on the scan data.

Scanning
Test Name: FILTER
14:09 7Feb01
Cell # 1

Wavelength	Abs
350	0.144
351	0.143
352	0.142
353	0.150
354	0.166
355	0.187
356	0.246
357	0.332
358	0.404
359	0.454

ID#: 1
Baseline collected 7Feb01

Use all data	Graph	Start nm	End nm
--------------	-------	----------	--------

To use all the scan data

1. With your table of scan data displayed on the edit screen, press **Use all data**.

To select specific start and end wavelengths

1. With your table of scan data displayed on the edit screen, use the arrow keys on the keypad to move the highlight symbol (→) to the appropriate data point in the table.

- Press **Start nm** or **End nm**. The instrument highlights the selected data points.
You can press **Graph** to display the plot using the highlighted data points.

3-Point Net

When you use the 3-Point Net program, you can perform these tasks:

- Recall a test **OR** set up your test parameters
- Run the Cell Correction program (GENESYS 10 UVscanning model only)
- Measure a blank
- Measure unknowns

To get started, press the **TEST** key on the keypad. When the **Test Types** screen appears, highlight **3-Point Net** and press **ENTER**.

3-Point Net		8:01am 22Jan01	
		BLANK	
Test Name	BILIRUBIN		
Wavelength 1	610nm		
Wavelength 2	660nm		
Wavelength 3	680nm		
Factor	1.000		
Units	mg/mL		
Sample Positioner	Auto 6		
Number of Samples	1		
More parameters...			
Press ↑ or ↓ to select item to change.			
	Save Test	Stored Tests	Run Test

Recalling a test

- With the **3-Point Net** screen displayed, press **Stored Tests**. A list of stored tests appears.
- Use the arrow keys to highlight the name of the test you want to recall and press **ENTER**. The parameters for the selected test appear on the screen.

From this screen, you can:

- Set up test parameters
- Run the Cell Correction program (GENESYS 10 UVscanning model only)
- Save a test
- View the list of stored tests
- Measure a blank
- Measure unknowns

Setting up test parameters

- With the **3-Point Net** screen displayed, use the arrow keys to highlight the name of the parameter you want to set.
- When the parameters are set, you can press **Save Test** to save the test or **Run Test** to measure a blank or unknowns.

Taking measurements

Taking measurements automatically (Auto 6 or Auto 3)

- With the **3-Point Net** screen displayed and the parameters set, press **Run Test**. The **3-Point Net** measurement screen appears.

3-Point Net				7:59 7Mar01					
Test Name: -----				BLANK					
ID#	Abs 610nm	Abs 660nm	Abs 680nm	Result C					

<div style="border: 1px solid black; padding: 5px; margin: 10px auto; width: 80%;"> Insert samples 1 - 5 into positions 1 - 5 Press ENTER to measure </div>									
<table border="1" style="width: 100%; height: 20px;"> <tr> <td style="width: 25%;"></td> <td style="width: 25%;"></td> <td style="width: 25%;"></td> <td style="width: 25%;"></td> </tr> </table>									

- Place the blank and the unknowns in the correct cell positions.
- Press **ENTER** to start the measurements. The instrument automatically measures the blank first, then measures the unknowns and displays the sample measurements on the screen.

Taking measurements manually (using Manual 6 or Single Cell Platform)

- With the **3-Point Net** screen displayed and the parameters set, press **Run Test**. The **3-Point Net** measurement screen appears.

Using the Instrument

3-Point Net		8:05am 22Jan01						
Test Name: BILIRUBIN								
ID#	Abs 610nm	Abs 660nm	Abs 680nm	Result mg/mL				
<table border="1"> <tr> <td>Measure Blank</td> <td> </td> <td> </td> <td> </td> </tr> </table>					Measure Blank			
Measure Blank								

Multiwavelength		8:07am 22Jan01	
BLANK			
Test Name	-----		
Measurement Mode	Absorbance		
Sample Positioner	Auto 6		
Number of Samples	1		
Cell Correction	Off		
ID# (0=OFF)	1		
Auto Print	On		
Press ↑ or ↓ to select item to change.			
Set nms	Save Test	Stored Tests	

- Place the blank and unknowns in the cell holder. If your instrument is equipped with a 6-Position Cell Holder, be sure to place the blank in the B position. You can place up to five samples in the cell holder.
- Press **Measure Blank** to measure the blank. If your instrument is equipped with a 6-Position Cell Holder, it automatically moves to the B position to measure the blank. When it

completes the measurement, it returns to its previous cell position.

- Press **Measure Sample** to measure the unknowns. The sample measurement appears on the screen. If your instrument is equipped with a 6-Position Cell Holder, press the cell position buttons on the keypad to reposition the cell holder and measure the rest of the unknowns manually.

Multiple Wavelengths

When you use the Multiple Wavelengths program, you can perform these tasks:

- Recall a test **OR** set up your test parameters
- Run the Cell Correction program (GENESYS 10 UVscanning model only)
- Add or delete wavelengths and factors
- Measure a blank
- Measure unknowns

To get started, press the **TEST** key on the keypad. When the **Test Types** screen appears, highlight **Multiple Wavelengths** and press **ENTER**.

Recalling a test

- With the **Multiple Wavelengths** screen displayed, press **Stored Tests**. A list of stored tests appears.
- Use the arrow keys to highlight the name of the test you want to recall and press **ENTER**. The parameters for the selected test appear on the screen.

From this screen, you can:

- Set up test parameters
- Run the Cell Correction program (GENESYS 10 UVscanning model only)
- Save a test
- View the list of stored tests
- Measure a blank
- Measure unknowns

Setting up test parameters

- With the **Multiple Wavelengths** screen displayed, use the arrow keys to highlight the name of the parameter you want to set.
*Refer to the procedures below for specific instructions on adding or deleting wavelengths and factors.
- If you have previously selected the wavelengths you wish to measure, you can press **Save Test** to save the test or **Run Test** to measure a blank or unknowns.
- If you have not selected the wavelengths, you can add wavelengths and factors as shown below.

Adding wavelengths & factors

Note: You can enter factors only when the measurement mode is set to Concentration/Factor.

1. With the **Multiple Wavelengths** screen displayed, press **Set nms**. The wavelength screen appears, listing the wavelengths and factors specified for the measurements.

Multiwavelength		8:18am 22Jan01	
Test Name: -----		BLANK	
WL#	nm		
1	610		
2	660		
3	680		
4	----		

Page 1
Press ↑ or ↓ to view data

Edit	Add nm	Delete nm	Run Test
------	--------	-----------	----------

2. Use the arrow keys to highlight the position where you want to enter the first wavelength and factor pair.
3. Press **Add nm**.
4. Enter the values for the wavelength and factor and press **ENTER**.
5. When the values are correct, press **Add nm**.
6. Continue until you have entered all the wavelengths and factors.

Deleting wavelengths & factors

1. With the **Multiple Wavelengths** screen displayed, use the arrow keys to highlight **Set nms**. The wavelength screen appears, listing the wavelengths and factors specified for the measurements.

Note: If no wavelength values have been entered, the wavelength and factor columns will be empty.

2. Use the arrow keys to highlight the first wavelength and factor pair you want to delete.
3. Press **Delete nm**.

Taking measurements**Taking measurements automatically (Auto 6 or Auto 3)**

1. The **Multiple Wavelength** acquisition can be accessed from either the **Set nms** screen shown above or from the **Multiple Wavelength** set up screen. Press **Run Test**. The **Multiple Wavelength** measurement screen appears.

Multiwavelength		8:30am 22Jan01	
Test Name: -----		BLANK	
ID#: 1			
nm	Result		
-----	Abs		
-----	-----		
<div style="border: 1px solid black; padding: 5px; margin: 10px auto; width: fit-content;"> Insert sample 1 into position 1 Press ENTER to measure </div>			

--	--	--	--

2. Place the blank and the unknowns in the correct cell positions.
3. Press **ENTER** to start the measurement. The instrument automatically measures the blank first, then measures the unknowns and displays the sample measurements on the screen.

Taking measurements manually (using Manual 6 or Single Cell Platform)

1. With the **Multiple Wavelength** screen displayed and the parameters set, press **Run Test**. The **Multiple Wavelength** measurement screen appears.
2. Place the blank and unknowns in the cell holder. If your instrument is equipped with a 6-Position Cell Holder, be sure to place the blank in the B position. You can place up to five samples in the cell holder.
3. Press **Measure Blank** to measure the blank. If your instrument is equipped with a 6-Position Cell Holder, it automatically moves to the B position to measure the blank. When it completes the measurement, it returns to its previous cell position.

Using the Instrument

4. With the list of wavelengths (and factors) displayed, press **Measure Samples** to measure the unknowns. The instrument measures the absorbance at each wavelength and displays it on the screen. If you have set the measurement mode to Concentration/Factor, the instrument also displays the calculated concentration at each wavelength. If your instrument is equipped with a 6-Position Cell Holder, press the cell position buttons on the keypad to reposition the cell holder and measure the rest of the unknowns manually.

Using the Performance Validation Program

Overview

The Performance Validation program allows you to run tests to check the performance of your instrument. Available tests include:

- Wavelength Accuracy - Internal
- Wavelength Accuracy - Standards
- Photometric Accuracy
- Noise Measurement
- Stray Light
- Internal Printer Test
- RS232C Test
- Analog Output Test

Running the appropriate performance validation tests regularly and maintaining a log of your results helps document the reliability of the instrument and indicates potential performance issues.

Note: *If you have a printer installed and turned on, the instrument automatically prints out the test results for each performance validation test that you run. You can also press the **PRINT** key to print another copy of the results.*

Accessing the Performance Validation tests

1. Press the **TESTS** key on the keypad. The **Test Types** screen appears.
2. Highlight Performance Validation and press **ENTER**. The **Performance Validation** screen appears.

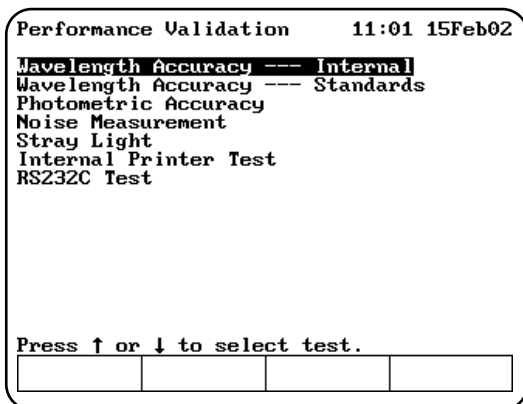

Troubleshooting checklist

If a Performance Validation test fails, follow the instructions below to help you diagnose common problems that may cause a test to fail. If a test continues to fail after you have tried all the recommendations in the list, follow the troubleshooting list for the test being run (included with the description of each test).

- Make sure you are following the instructions for the test properly.
- Make sure filters and standards are clean.
- Make sure the sample compartment door is closed while the test is running.
- Make sure the sample compartment is clear of any obstructions.
- Make sure the 6-Position Cell Holder is installed properly; run the test once with the sample compartment door open to verify that the 6-Position Cell Holder is moving smoothly.
- Turn the instrument power OFF, then ON; verify that no problems are indicated by the power-on diagnostics.
- Make sure the lamp is ON.
- Make sure the lamp compartment is clear of any obstructions.



WARNING

Do not open the lamp compartment unless the instrument power is OFF.

Do not turn the instrument power ON unless the lamp compartment is closed!

Wavelength Accuracy - Internal

This test locates the peaks and displays the expected and measured wavelengths for the peaks at the following wavelengths:

- **UV-Vis instruments** - measures wavelength accuracy for the xenon lamp at 229, 529 and 883nm.
- **Vis instruments** - measures wavelength accuracy for the internal didymium filter at 585 and 807nm.

Using the Performance Validation Program

When running the internal standard test, remember that:

- The wavelengths are preset and cannot be changed.
 - The xenon lamp has a preset tolerance of $\pm 2.0\text{nm}$ and the internal didymium filter has a preset tolerance of $\pm 2.5\text{nm}$.
 - The cell holder should be empty.
1. With the **Performance Validation** screen displayed, use the arrow keys to highlight **Wavelength Accuracy - Internal**.
 2. Press **ENTER**. The **Wavelength Accuracy - Internal** screen appears.
 3. Press **Start Test** to run the test. The results of the test appear on the screen, indicating pass or fail for each wavelength.

Expected nm	Tolerance $\pm\text{nm}$	Measured nm	Result
229	± 2	228	Pass
529	± 2	527	Pass
882	± 2	883	Pass

Make sure the Blank position is empty.
Press Start Test

			Start Test
--	--	--	---------------

If the test fails, follow these guidelines:

- Repeat the test several times to verify that the test is failing consistently.
- Contact technical support for more troubleshooting advice.

Wavelength Accuracy - Standards

This test measures the absorbance of a filter standard at up to five wavelengths and compares the results with specified tolerances. The wavelengths and tolerances are preset, but you should change them to the values on the certificate of calibration included with your standards.

Note: *Only the middle wavelength of the SPECTRONIC Standards wavelength standard is certified. The wavelength accuracy test passes or fails based on this wavelength alone. The other two wavelengths may be*

used for long-term repeatability testing. The initial target values may be determined by running the wavelength accuracy test once, and taking note of the values reported in the Measured Wavelength column.

1. With the **Performance Validation** screen displayed, use the arrow keys to highlight **Wavelength Accuracy - Standards** and press **ENTER**. The **Wavelength Accuracy - Standards** screen appears.

Expected nm	Tolerance $\pm\text{nm}$	Measured nm	Result

Entry:
Enter Wavelength (190 - 1100)

	Add nm		
--	-----------	--	--

Adding wavelengths

1. If you need to add a wavelength, press **Add nm** and enter the wavelength value in the **Entry** field.
2. When the value is correct, press **Add nm** again to add the wavelength to the list. The screen changes to prompt you to enter the tolerance for the wavelength you just entered.

Expected nm	Tolerance $\pm\text{nm}$	Measured nm	Result
339			

Entry:
Enter Tolerance (1.0-20.0)

	Add Tolerance		
--	------------------	--	--

3. Enter the tolerance value in the **Entry** field.
4. When the value is correct, press **Add Tolerance** to add the tolerance.

Deleting wavelengths

1. If you want to delete a wavelength, use the arrow keys to highlight the appropriate wavelength.

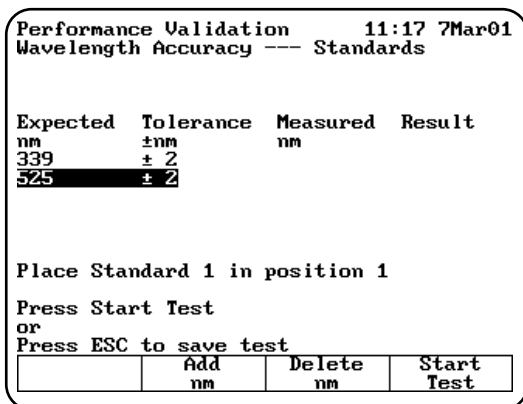

2. When the appropriate wavelength is highlighted, press **Delete nm** to confirm that you want to delete the wavelength.

Running the test

1. With the **Wavelength Accuracy - Standards** screen displayed, make sure that the wavelengths and tolerances are set correctly.
2. Press **Start Test** to run the test. The results of the test appear on the screen, indicating pass or fail for each wavelength.

If the test fails, follow these guidelines:

- Repeat the test several times to verify that the test is failing consistently.
- Make sure the target value you entered for the calibrated wavelength is the same as the value printed on the SPECTRONIC Standards certificate.
- Make sure the tolerance value you entered for the calibrated wavelength is the same as the value given in the SPECTRONIC Standards User's Manual.

Photometric Accuracy

This test measures the absorbance (or %transmittance) of a set of standards and compares the results with specified tolerances. The absorbances and tolerances are preset, but you should change them to the values on the report of calibration included with your standards.

Note: You can display the tolerances for this test in either absorbance or %transmittance.

1. With the **Performance Validation** screen displayed, use the arrow keys to highlight **Photometric Accuracy**.
2. Press **ENTER**. The **Photometric Accuracy** screen appears.

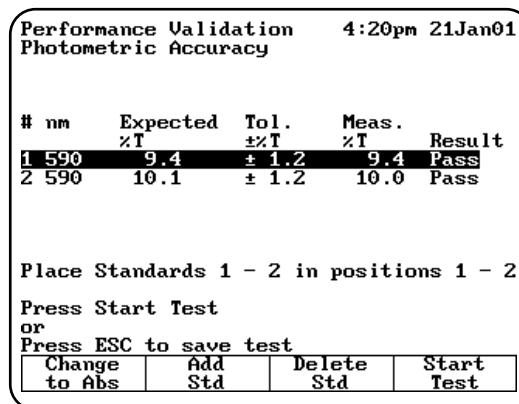

Selecting the mode

1. To switch between absorbance and %transmittance, press **Change to %T** (or **Change to ABS**) until the appropriate mode appears.

Adding standards

You will need to set three values whenever you add a standard - the wavelength, the absorbance (or %transmittance) and the tolerance value.

1. If you need to add a standard, press **Add Std** and enter the wavelength value in the **Entry** field.
2. When the wavelength value is correct, press **Add Std** again to add the wavelength to the list. The screen changes to prompt you to enter the absorbance (or %transmittance) for the wavelength you just entered.
3. Enter the tolerance value in the **Entry** field.
4. Press **Start Test** or Press **ESC** to save test.

Using the Performance Validation Program

Performance Validation 11:18 7Mar01
Photometric Accuracy

#	nm	Expected %T	Tol. ±%T	Meas. %T	Result
1	590	50.0	± 1.2		
2	590	10.0	± 1.2		
3					

Entry:
Enter Wavelength (190 - 1100)

	Add nm		
--	-----------	--	--

Performance Validation 11:22 7Mar01
Photometric Accuracy

#	nm	Expected %T	Tol. ±%T	Meas. %T	Result
1	590	9.4	± 1.2	9.5	Pass
2	590	10.1	± 1.2	10.1	Pass

Place Standards 1 - 2 in positions 1 - 2
Press Start Test
or
Press ESC to save test

Change to Abs	Add Std	Delete Std	Start Test
------------------	------------	---------------	---------------

Deleting standards

1. If you need to delete a standard, use the arrow keys to highlight the appropriate standard.

Performance Validation 11:19 7Mar01
Photometric Accuracy

#	nm	Expected %T	Tol. ±%T	Meas. %T	Result
1	590	50.0	± 1.2		
2	590	10.0	± 1.2		
3	590	47.7	± 1.2		

Place Standards 1 - 3 in positions 1 - 3
Press Start Test
or
Press ESC to save test

Change to Abs	Add Std	Delete Std	Start Test
------------------	------------	---------------	---------------

2. When the appropriate standard is highlighted, press **Delete Std** to confirm that you want to delete the standard.

Running the test

1. With the **Photometric Accuracy** screen displayed, make sure that the wavelengths, absorbance (or %transmittance) values and tolerances are set correctly.
2. Press **Start Test** to run the test. The results of the test appear on the screen, indicating pass or fail for each wavelength.

If the test fails, follow these guidelines:

- Repeat the test several times to verify that the test is failing consistently.
- Make sure you follow the guidelines provided with the standard reference materials.
- Contact technical support for more troubleshooting advice.

Noise Measurement

This test measures the amount of noise (peak-to-peak) at specified wavelengths:

- **UV-Vis instruments** - measures noise at 230 and 340nm
- **Vis instruments** - measures noise at 500nm

All parameters are preset and cannot be changed. When running the noise test, remember that:

- The wavelengths are preset and cannot be changed.
 - The Blank position should be empty.
 - Position #1 should be used for the 2A filter in a 6-cell holder only (if measured).
1. With the **Performance Validation** screen displayed, use the arrow keys to highlight **Noise Measurement**.
 2. Press **ENTER**. The **Noise Measurement** screen appears.

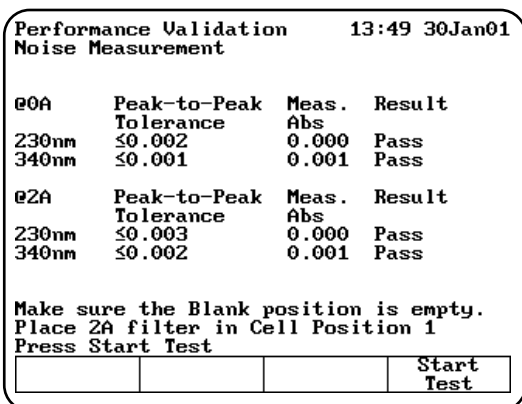

3. Make sure that the Blank position is empty and insert the 2A filter in position #1 if you are measuring at 2A.
4. Press **Start Test** to run the test. The results of the test appear on the screen, indicating pass or fail for each wavelength.

If the test fails, follow these guidelines:

- Repeat the test several times to verify that the test is failing consistently.
- Make sure the instrument is warmed up for at least 30 minutes, standby mode = OFF.
- Make sure the instrument is plugged into a stable power supply.
- Contact technical support for more troubleshooting advice.

Stray Light

This test measures the amount of stray light at selected wavelengths and compares them to specified tolerances. The wavelengths are preset and cannot be changed. You should change the tolerances for the desired wavelengths. Running the stray light test takes approximately thirty seconds.

When running the stray light test, remember that:

- You will need the SPECTRONIC Standards Stray Radiant Energy filters or equivalent.
- Position B should be empty.
- Position #1 should be used for SRE 220.
- Position #2 should be used for SRE 340.
- Position #3 should be used for SRE 400.

You may use other filters, but they must have ≤0.1%T at the wavelength of interest.

1. With the **Performance Validation** screen displayed, use the arrow keys to highlight **Stray Light**.
2. Press **ENTER**. The **Stray Light** screen appears.

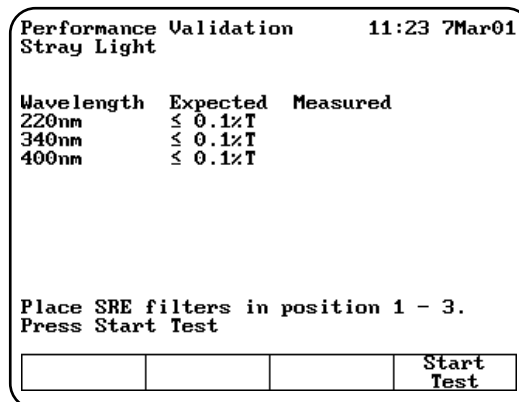

Running the test

1. With the **Stray Light** screen displayed, make sure that the wavelengths and tolerances are set correctly.
2. Press **Start Test** to run the test. The results of the test appear on the screen, indicating pass or fail for each wavelength.

If the test fails, follow these guidelines:

- Repeat the test several times to verify that the test is failing consistently.
- Make sure all the filters being used are SPECTRONIC Standards Stray light filters, or exact equivalents.
- Contact technical support for more troubleshooting advice.

Internal Printer Test

The Internal Printer test allows you to verify that the internal printer is functional. To run the test, you will need to have the internal printer installed. Running the internal printer test takes no more than 20 seconds after you press **Stop**.

1. Verify that the internal printer is installed properly and is selected. If necessary, press the **UTILITY** key, then select the internal printer.
2. With the **Performance Validation** screen displayed, use the arrow keys to highlight **Internal Printer Test**.

Using the Performance Validation Program

3. Press **ENTER**. The **Internal Printer Test** screen appears.

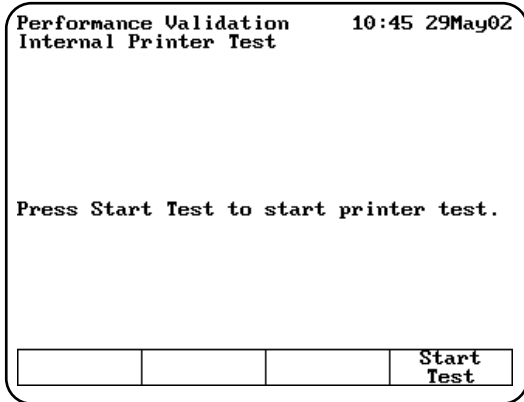

4. Press **Start Test** to run the test. The test print routine appears on the printer.

While the test is running, you can press **Stop Test** to stop it.

If the test fails, follow these guidelines:

- Make sure that the internal printer is the selected printer device on the **Utilities** screen.
- Make sure that the internal printer is installed correctly. (Return to the main screen and press **ENTER**. If the paper does not move, the printer may not be installed correctly.)
- Make sure that the thermal paper is threaded with the thermal side toward the printer head (the outside surface of the roll is the thermal surface).
- Contact technical support for more troubleshooting advice.

RS232C Test

The RS232C test allows you to verify that the RS232C port is functional. To run the test, you will need to have the RS232 Test Plug (336035) attached to the RS232C port on the back panel of the instrument. Running the RS232C test takes approximately five minutes.

1. Verify that the RS232 Test Plug is securely attached to the RS232C port on the back panel of the instrument.
2. With the **Performance Validation** screen displayed, use the arrow keys to highlight **RS232C Test**.

3. Press **ENTER**. The **RS232C Test** screen appears.

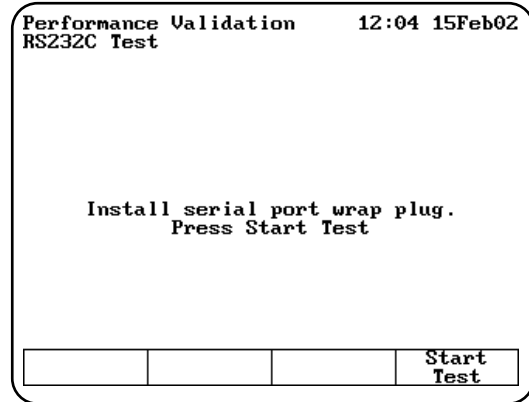

4. Press **Start Test** to run the test. When the test is complete, the message "RS232 OK" or "RS232 Failed" appears on the screen.

While the test is running, you can press **Stop Test** to stop it.

If the test fails, follow these guidelines:

- Make sure that the test plug is installed correctly and is not loose or damaged.
- Contact technical support for more troubleshooting advice.

Analog Output Test

The Analog Output test sends an output signal to an analog recorder. The signal alternately ramps from low to high voltage and back again. This produces a plot on the recorder that will vary depending on the paper speed. To run the Analog Output test, you will need to have an analog recorder connected to the instrument.

1. Make sure that the analog recorder is securely connected to the instrument.
2. With the **Performance Validation** screen displayed, use the arrow keys to highlight **Analog Output Test**.
3. Press **Enter**. The Analog Output Test screen appears.
4. Press **Start Test** to run the test. While the test is running, you can also press **Stop Test** to stop it.

If the test fails, contact your distributor for technical support.

Connecting & Using Accessories

General information

The spectrophotometer supports a variety of sample-handling accessories. This section describes how to connect and use the following types of accessories:

- Cell holders and cell holder accessories
- Internal printer
- External computer

Cell holders & cell holder accessories

If the spectrophotometer includes a 6-Position Cell Holder (335901, 335903, and 335907), you can install a single-position cell platform. However, if your spectrophotometer is a Single-Position Cell Platform model (335900, 335902, 335906), you cannot upgrade it to accommodate a 6-Position Cell Holder.

The following table lists the cell holders and cell holder accessories available for the spectrophotometer.

Catalog #	Description
335916	Single Cell Holder Platform -with single cuvette holder installed. Included in 335900 and 335902 models.
336014	Test Tube Holder - Accommodates test tubes up to 25mm in diameter and up to 102mm tall, C.O.D. reagent vials and Hach vials (24mm diameter and 60mm tall); fits on 335927 6-Position Cell Holder (holds three) or 335916 Single Cell Holder Platform (holds one).
335917	Adjustable Filter Holder - Accommodates glass or plastic filters up to 50mm long x 80mm tall x 10mm thick; minimum thickness of 1mm; fits on 335927 6-Position Cell Holder (holds three) or 335916 Single Cell Holder Platform (holds one).
335428	Filter Holder - Accommodates filters/lenses up to 50mm long x 80mm tall x 1-8mm thick; fits on 335927 6-Position Cell Holder (holds three) or 335916 Single Cell Holder Platform (holds one).
335079	Thermal Block - Controls the temperature of one 10mm pathlength square cuvette within the range of 20 to 100°C; fits on 335927 6-Position Cell Holder (holds three) or 335916 Single Cell Holder Platform (holds one); requires external water bath and 335920 Accessory Door for routing circulating water.
336028	Single Cell Holder - Accommodates 10mm test tubes, 10mm square cuvettes, short pathlength cuvettes with spacers, and 10mm ultra-microcell; fits on 335927 6-Position Cell Holder or 335916 Single Cell Holder Platform.
335911	Cylindrical Longpath Cell Holder - Accommodates a cylindrical cell with 10-50mm pathlength, 22-25mm diameter; fits on 335927 6-Position Cell Holder (holds three) or 335916 Single Cell Holder Platform (holds one).
335912	Rectangular Longpath Cell Holder - Accommodates a rectangular cell with 10-50mm pathlength, 12.5mm wide; fits on 335927 6-Position Cell Holder (holds three) or 335916 Single Cell Holder Platform (holds one).
336012	Cylindrical Longpath Cell Holder - Accommodates one cylindrical cell with 10-100mm pathlength, 22-25mm diameter; requires 335916 Single Cell Holder Platform.
335112	Rectangular Longpath Cell Holder - Accommodates one rectangular cell with 10-100mm pathlength, 12.5mm wide; requires 335916 Single Cell Holder Platform.
335988	Internal Printer Assembly - Includes 1 roll of paper.
335975*	Sipper System - For measurements in the 325-1100 wavelength range; includes 335982 Peristaltic pump, 335171 Optical glass flowcell, 335916 Single cell platform, 335920 Accessory door kit and pump tubing, 110 VAC.
335976*	Sipper System - Same as 335975 except for measurements in the 190-1100 wavelength range, 110 VAC.

Connecting & Using Accessories

Catalog #	Description
335982*	Peristaltic Pump - Includes set of Norprene pump tubing; used with 335171 Optical Glass flowcell or 335172 Quartz flowcell and 335920 Accessory Door Kit. 115V, 50/60Hz.
335920-000	Accessory Door Kit - Includes spout and four ports for circulating water around water-jacketed cells, or for waste outlet for flowcell systems.
335977-000	Funnel Flowcell - 10mm pathlength, optical glass, for measurements between 335-1100nm; fits on 335916 Single Cell Holder Platform (holds one).
335927-000	6-Position Cell Holder - platform with six (6) 336028 single cell holders installed. Included with 335901 and 335903 models.
333150-000	SPECTRONIC Standards
336029-000	Spacers - 5mm, set of 2, for use with 5mm short pathlength cuvettes in any square cell holder.
336030-000	Spacers - 8mm, set of 2, for use with 2mm or 1mm short pathlength cuvettes in any square cell holder.
335942-000	Serial interface cable to connect the spectrophotometer to an IBM-compatible PC.
331751-000	Ultra-microcell - 10 μ l fill volume, 1mm pathlength, 40mm tall, quartz.
331752-000	Ultra-microcell - 70 μ l fill volume, 10mm pathlength, 50mm tall, quartz. Requires 335916 Single Cell Holder Platform (holds one) for optimal performance

Note: If you want to use 100mm longpath cells, you must install the Single-Position Cell Platform.

*To order an accessory with a Europlug, add -02 to the catalog number. To order an accessory with a UK plug, add -04 to the catalog number.

Changing cell holders

If you want to use longpath cells (cylindrical or rectangular), use test tubes, measure solid filters or regulate cell temperature via an external water circulator, you must install the appropriate cell holders. You can easily remove the 6-Position Cell Holder installed in the instrument and install other accessory cell holders.

Whenever you change from one type of cell holder to another, you must measure a blank. This ensures that the instrument can detect which type of cell holder is installed.

Removing the 6-Position Cell Holder

1. Open the sample compartment and let the sample compartment door rest on its hinge.
2. With one hand, loosen the captive thumbscrew.
3. With the other hand, pull straight up on the 6-Position Cell Holder and lift it out of the sample compartment.

Installing the 6-Position Cell Holder

1. Open the sample compartment and let the sample compartment door rest on its hinge.
2. With one hand, carefully lower the 6-Position Cell Holder straight down into the sample compartment.
3. With the other hand, tighten the captive thumbscrew.
4. Close the sample compartment.
5. Take a blank measurement to ensure that the instrument detects that you have installed the 6-Position Cell Holder.

Installing the Single-Position Cell Holder

1. With the sample compartment open, place the Single-Position Cell Platform as shown in Figure 5.
2. Tighten the screws securely.

Note: If the cell holder is not aligned correctly, you will not be able to tighten the screws.

3. Take a blank Measurement to ensure that the instrument detects that you have installed the Single-Cell Platform.

Installing accessory cell holders

1. Make sure that you have the correct cell holder installed. If you want to use 100mm longpath cells, you must install the Single-Position Cell Holder.
2. Install the desired accessory cell holders by tightening the screw on each cell holder.

Note: *You can install only three each of some accessory cell holders. Make sure to place them in positions B, 2 and 4.*

Internal printer

Installing the internal printer



WARNING

Turn off the instrument and disconnect the power cord from the outlet before installing the internal printer.

1. Loosen the captive screw (#1, Figure 6) on the lamp door by rotating it counterclockwise about ¼ turn.
2. Open the lamp door.
3. Use a pen or screwdriver to lift the tabs holding the door to the hinge (#2 & #3, Figure 6).
4. Slide the door off the hinge.
5. Remove the printer (already installed on the printer door) from its packing.
6. Unclip the connector wires on the door hinge.
7. Lower the hinge so it is out of the way.
8. Connect the wires (#4, Figure 6) and press into place with a small screwdriver. There is only one way that the connectors will fit. Each connector has a slight D shape. Make sure the side of the connector with the shiny metal contacts (see Figure 6) and faces away from the printer and towards the plastic door.
9. Use the clip on the hinge to secure the wires.
10. Install the printer door by sliding it back onto the hinge (#3, Figure 6).

11. Close the lamp door.
12. Tighten the captive screw (#1, Figure 6) on the printer door to hold it securely in place.
13. Load the paper into the printer (*see instructions in Setting up the instrument*).

Loading the paper in the internal printer

For instructions on loading the paper in the internal printer, see *Setting up the instrument*.

External Printers

GENESYS 10 models series 335906 and 335907 are able to print to external desktop printers supporting HP PCL format such as the HP DeskJet 600, 800 and 900 series printers.

Note: *PCL format does not support HP "Windows" printers*

To print to an HP PCL format printer, connect the 347070-189 parallel interface cable to the parallel printer port on the back of the instrument (#3, Figure 2b).

External computers

To connect an external computer, make sure that the pin-outs on the connectors are set according to the illustration below.

To connect an external computer, connect the computer cable to the 9-pin RS232C port on the back of the instrument (#2, Figure 2). Be sure to use a DB9 pin (female) to DB9 pin (female) interface cable (335942).

Contact technical support for more information about using an external computer with the spectrophotometer.

Protocol to use with external device:	
Baud rate	19,200
Data bits:	8
Parity:	Off
Stop Bit:	1

Connecting & Using Accessories

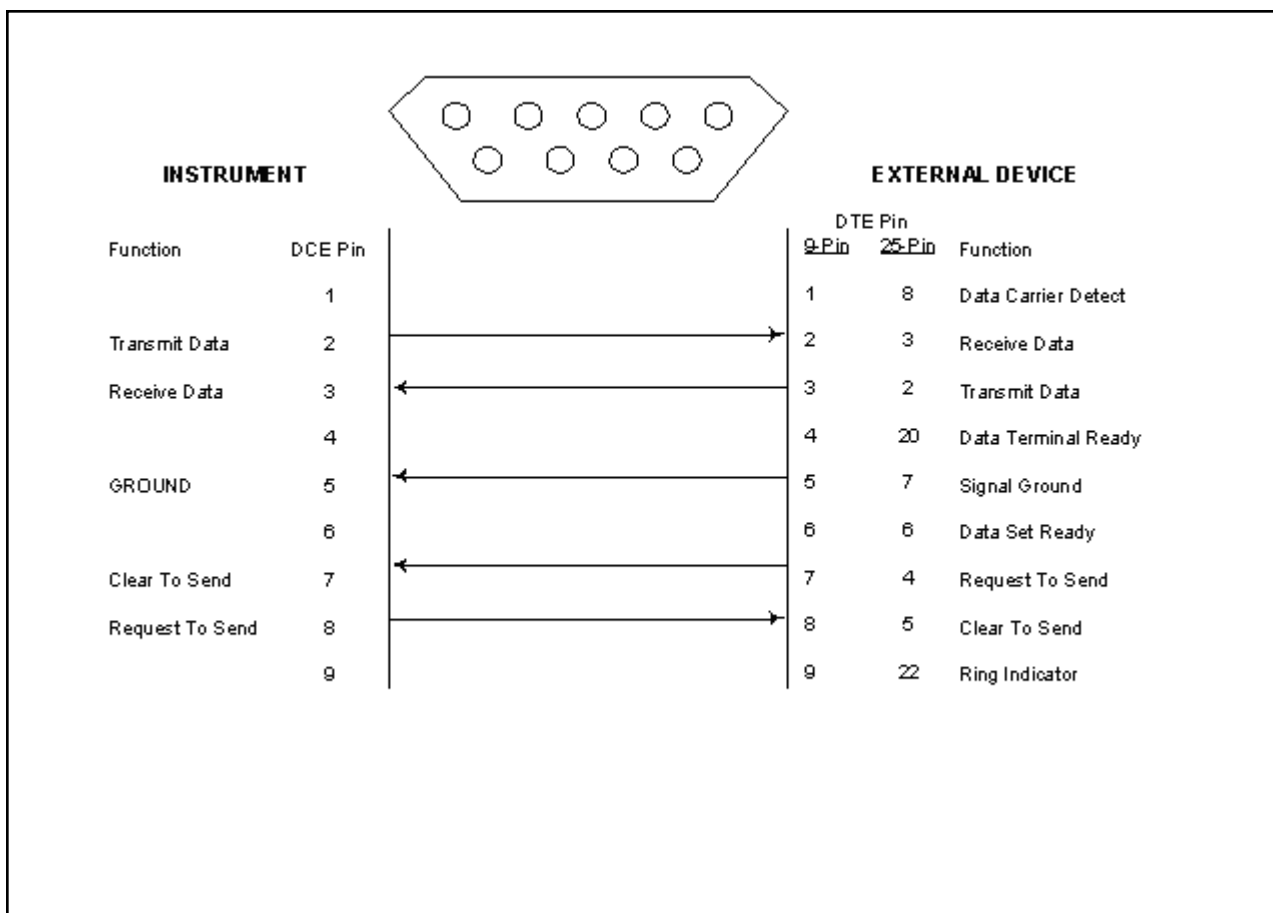

Performing Maintenance Procedures

The spectrophotometer is durable and reliable, so routine maintenance is minimal. This section includes complete instructions for:

- Routine care, cleaning and maintenance of the instrument and cells
- Changing the fuse and voltage setting

This section also includes a list of replacement parts and accessories.



WARNING

Operating the instrument with the cover off exposes the operator to potentially dangerous voltages and ultraviolet (UV) radiation. Therefore, the distributor recommends that only authorized service representatives perform procedures requiring removal of the instrument cover and replacement of electrical components. To protect both yourself and the instrument, be sure to contact an authorized service representative to perform any service procedure you do not feel comfortable performing.

Routine care

Routine care for the spectrophotometer does not require a lot of time. To help minimize maintenance time and to increase the life and performance of your instrument, please follow these guidelines:

- To prevent dust from accumulating on and in the instrument, always replace the dust cover when the instrument is not turned on. The dust cover, supplied with the instrument, is resistant to most aqueous solutions.
- Do not use or store the instrument in a corrosive environment.
- Gently wipe the outside of the instrument with a soft cloth to remove any dust or spills. Water, isopropyl alcohol and other common laboratory cleaning agents may be used if necessary.

- Always clean up spills to prevent or minimize damage to the instrument. If concentrated acids or bases, or any hydrocarbon materials, are spilled on the instrument, be sure to clean up the affected area *immediately*.
- Use water, alcohol or other common laboratory cleaning agents to clean the keyboard. It is recommended that you clean spills off the keyboard as soon as they occur.

Cleaning

Cleaning and maintenance of cells

Cleaning of cells both inside and out is important not only because any contaminating material may absorb light, but also because material within the cell may react chemically with subsequent reagents or standards introduced into the cell. Cleaning methods depend to some extent on the nature of the contaminating material. Sodium (or ammonium) hydroxide and dilute hydrochloric acid may be used to remove some acidic and basic contaminants, respectively. Clorox (undiluted or 1:1) is very effective in removing proteinaceous and bacterial contaminants. You may also use Cell Cleaning Solution (332260-169) to clean your cells.



WARNING

Handle and dispose of chromic acid with care!

Finally, soaking in chromic acid will remove most contaminants, but the acid should be handled, and disposed of, with care. Because of the exothermic reaction of the acid and water, any heat generated should be quickly dissipated to avoid altering the pathlength of the cell. Cells should not be placed in hot chromic acid.

Note: *To prepare chromic acid cleaning solution, slowly add (with stirring) 800mL of concentrated sulfuric acid to 458mL of distilled water containing 92 g of sodium dichromate ($\text{Na}_2\text{Cr}_2\text{O}_7 \cdot 2\text{H}_2\text{O}$). This cleaning solution should be red-brown. Discard, using proper disposal methods, when green tinge appears.*

Performing Maintenance Procedures

Cells with scratches in the optical path should be discarded because scratches will cause anomalous absorbance readings. Cells should be protected during cleaning and never thrown into a bath with glassware where they might get scratched, or placed in a wire rack that might scratch them. The outside of the cells may be wiped with a soft, lint-free tissue, and should be kept free of fingerprints.

Micro flowcells can be kept clean by:

- Flushing well with a solvent after use
- Aspirating dilute acid, base, non-filming detergent or Clorox through the cell in short bursts
- Storing with distilled water in the cell

Cleaning the windows of the sample compartment

Follow these guidelines to clean the windows of the sample compartment:

- **Do not use acetone** to clean the windows of the sample compartment. Instead, use a non-abrasive laboratory cleaning solution (Cell Cleaning Solution, 332260-169), distilled water or alcohol.
- Use the liquid and a soft, lint-free cloth to clean the windows. Do not apply too much pressure or the surface of the windows may be damaged. Be sure to remove all fingerprints.

Changing the fuse

The fuse is located in the power entry module located at the center of the back panel of the instrument (Figure 2).

- 120VAC, 2.5A, Slo-Blo
- 240VAC, 1.25A, Slo-Blo (2 required)

See *Replacement parts* on page 5-3 for a list of replacement part numbers.



WARNING

The instrument fuse must be replaced with the same type and rating fuse.



WARNING

If the fuse fails repeatedly, it may indicate a serious problem with the instrument. Contact your service representative as soon as possible.

1. Turn off and unplug the instrument.
2. Position the instrument so you can access the power entry module on the back of the instrument.
3. Remove the power cord.
4. Insert a flat-blade screwdriver into the notch (Figure 8) on the fuse cover and pry off the cover.
5. Use a flat-blade screwdriver to remove the fuse holder (Figure 9).
6. Unsnap both fuses (Figure 10) to remove them.
7. Insert the new fuses, pushing them in so they snap into place.
8. Replace the fuse cover.
9. Replace the power cord.
10. Plug the instrument back in the appropriate outlet and turn on the power.

Note: *If the fuse blows again, contact your distributor or service at the number(s) listed on the back cover.*

Replacing the tungsten lamp (for GENESYS 10 VIS spectrophotometers only)



WARNING

This lamp gets very hot during operation. Before removing the lamp, turn off the instrument and allow the lamp to cool down for 10 minutes.



WARNING

Turn off and unplug the instrument before removing the cover of the lamp compartment..

1. Turn off and unplug the instrument.
2. Make sure that the lamp has had time (at least 10 minutes) to cool off.
3. Loosen the captive screw (#1, Figure 7) on the lamp door by rotating it counterclockwise about ¼ turn.
4. Raise the lamp door.
5. Unscrew the thumbscrew (#2, Figure 7) holding the lamp assembly (#3, Figure 8) in place.
6. Carefully pull the assembly out until you can reach the connector.
7. Release the tab (#4, Figure 7) and disconnect the cable.
8. Unpack the new lamp assembly.
9. Use a soft, lint-free cloth to wipe off any fingerprints on the lamp.
10. Connect the cable to the connector.
11. Position the new assembly as shown in #5, Figure 7, making sure to align the pins correctly.
12. Tighten the thumbscrew (#2, Figure 7).
13. Close the lamp door.
14. Turn on instrument and press **UTILITY** key.
15. Press the arrow keys to highlight **Lamp Hours** and press **ENTER**.
16. Press **ENTER** to reset lamp hours to zero.



WARNING

Do not touch the lamp with your fingers!

Replacement parts

Catalog #	Description
335916	Single Cell Platform - with single cuvette holder installed. Included in 335900, 335902, and 335906 models.
336028	Single Cell Holder - Accommodates 10mm test tubes, 10mm square cuvettes, short pathlength cuvettes with spacers, and 10mm ultra-microcell; fits on 335927 6-Position Cell Holder or 335916 Single Cell Holder Platform.
335927	6-Position Cell Holder - with six (6) 336028 single cell holders installed. Included with 335901, 335903 and 335907 models.
335988	Internal Printer Assembly.
333152	Sensitized Paper - (100 sheets) for SPECTRONIC Standards.
335965	Replacement Dust Cover.
335954	Printer Paper - Package of 5 rolls.
335902-10001	GENESYS 10 Operator's Manual.
335901-10020	Service Manual , includes printed service manual and CD ROM.
335901-10040	GENESYS 10 Service Manual , includes CD ROM only.
335971	Replacement silicon tubing for 335982 Peristaltic pump, 5mm OD, 1.5mm ID, 25 foot roll.
335923	Tungsten Lamp Assembly - For all GENESYS 10 Vis spectrophotometers.

Performing Maintenance Procedures

Appendix A - Specifications

Specifications

Table 1 Specifications for GENESYS 10 spectrophotometers¹

	GENESYS 10 Vis	GENESYS 10 UV	GENESYS 10 UV Scanning
Spectral Bandwidth	5nm	5nm	
Optical System	Single-beam, grating-based, single detector	Split-beam, grating-based, dual detectors	
Lamp Source; Lifetime	Tungsten-halogen; 1000 hours typical	Xenon; 5 years typical	
Wavelength:			
Range	325 - 1100nm	190 - 1100nm	
Accuracy	± 1.0nm		
Repeatability	± 0.5nm		
Display	320 x 240 pixel backlit LCD, 3.8" x 2.8"		
Photometric:			
Range	0.3 - 125%T; -0.1 - 3.0A; 0 - 9999C		
Readout	Absorbance, Transmittance, Concentration		
Accuracy ²	0.5% OR 0.005A whichever is greater up to 2A		
Noise	≤ 1mA at 0A; ≤ 2mA at 2A, peak-to-peak		
Drift	≤ 2mA/hour after warmup	≤ 1mA/hour	
Stray Light ³	≤ 0.1%T at 340 and 400nm	≤ 0.1%T at 220, 340 and 400nm	
Standard Interface	Bi-directional RS232C		Bi-directional RS232C; parallel output in PCL format
Cell Holder	1-position OR automatic 6-position cell holder		
Keyboard	Membrane keypad		
Software	Absorbance/Transmittance/Concentration, Standard Curve, Absorbance Ratio, Absorbance Difference, Kinetics, Survey Scan, 3-Point Net, Multiwavelength, Performance Validation		As G10 UV but with full-range scanning Scanning speed: 200-1000nm/min Sampling interval: 1, 2, 3, 5nm
Test Storage	Up to 40 sets of test parameters		
Languages	Software and Printout: English, French, German, Spanish, Italian (user selectable) Operator's Manual: English, French, German, Spanish, Italian		
Printer (optional)	40-column internal graphics		40-column internal graphics; external HP PCL printer

¹ These specifications are valid only after a 30-minute warm-up period (Vis unit only) and when the required environmental conditions (see below) are met.

² Measured using NIST 930D filters

³ 220nm, 340nm and 400nm measurements with SPECTRONIC Standards (#333150)

Appendix A - Specifications

	GENESYS 10 Vis	GENESYS 10 UV	GENESYS 10 UVscanning
Analog output (optional)	0 - 1V for -0.1 to 2.5A		Not available
Power Requirements	Selected automatically; 100 - 240 Volts		
Dimensions	330W x 410D x 235H mm (13" x 16" x 9")		
Weight	8.6 Kg (19lb)		
Warranty	1 year		

Table 2 Environmental and electrical requirements (meets the IEC 1010-1 international safety standard)

Line voltages
100 - 240 VAC \pm 10%
50 - 60 Hz
80 VA max
Operating environment
The instrument meets the specifications on the previous page under the following conditions after a 30-minute warm-up period.
Ambient temperature: 5° to 35° C (41° F to 95° F)
Relative humidity: 20% - 80% RH
Storage environment
-20° C to 70° C (-4° F to 158° F) Relative humidity not to exceed 0.040 pounds moisture per pound of dry air. Allow instrument to adjust to room temperature for 24 hours after taking it out of storage.
Temperature should be maintained at \pm 4° F. Relative humidity should be maintained to \pm 5%.
Altitude
From below sea level to 2000 meters (6562 feet)
For indoor use only
Installation Category II
Pollution Degree 2

Appendix B - Parameters

Parameter	Description
# of Wavelengths	Number of wavelengths set for multiple wavelength analysis
# of wavelengths for wavelength accuracy	Used to determine wavelength accuracy of unit
# Phot Accy Standards	Used to determine photometric accuracy of unit
%Transmittance	Sets transmittance value
Absorbance	Sets absorbance value
AutoPrint	Turns automatic printout on or off
Baseline Expiration	Sets time when baseline will expire
Cell Correction	Program that automatically corrects for variances in absorption between the cuvettes used to hold and measure samples
Cell Pos #	Position placed in light path; set by selection of sample positioner
Concentration	Sets concentration value
Correction Mode	Mode for cell correction collection
Curve Fit	Type of Line fit calculation
Delay Time	Time from Test Initiation to first measurement; allows for sample equilibration
Factor	Abs x Factor 1 = Concentration Abs/min x Factor 2 = Result
Factor 1	Abs(WL1) x Factor = Result
Factor 2	Abs(WL2) x Factor = Result
Factor 3-31	Abs(WL3-31) x Factor = Result
ID#	Numeric Identifier - autoincrements during test until reset or test is exited
Intercept	Where line crosses the y-axis (abs where conc=0)
Interval Time	Time between repeated readings
Languages	Language of any text on screen
Lock/Unlock	Used to protect stored tests from accidental deletion or alteration
Low/High Limits	Lowest & highest acceptable results, outside of which the result is flagged as 'Low' or 'High'
Measurement Mode	The type of photometric data reported for a measurement
Number of Matched Cuvettes	Number of cuvettes that will be run in the Correction Program (maximum of 5)
Number of Samples	Number of samples to be measured in the whole test
Number of Standards	Number of standards to be measured for standard curve
Phot Accy Tolerance	±Photometric accuracy acceptable
Pk-Pk Noise Tolerance	±Noise acceptable
Printer	Selects output mode

Appendix B - Parameters

Parameter	Description
Ref Wavelength	Internal Reference wavelength; for each reported measurement, measures analytical wavelength & reference wavelength. Reported measurement = Abs@Analytical WL - Abs@Reference WL
Ref Wavelength Correction	Turns internal zeroing on or off
Sample Positioner	Type of Positioner - Empty = no auto turret Manual = turret moved by buttons Auto 3 = turret auto moved - B, 2, 4 Auto 6 = turret auto moved - B,1,2,3,4,5
Scan Speed	nm/min for a scan
Setup Correction	Initiates the procedure to collect the data necessary to correct for cuvette variances
Slope	$\Delta\text{Abs}/\Delta\text{Concentration}$
SRE Tolerance	\pm Stray radiant energy acceptable
Standby	Time since last keystroke or instrument activity; powers down unit to minimum energy required.
Start Wavelength	Beginning wavelength for a scan
Statistics	Turns stats on or off; if ON, calculates average and Std Dev of results; statistics registers are cleared when Statistics = OFF and/or when instrument is OFF, and/or when test parameters are changed, and/or when test is saved (or resaved)
Std Concentration	Concentration of analyte in standard solution
Stop Wavelength	Ending wavelength for a scan
Test Name	User-defined name for test

Appendix C - Calculations

Calculations

Table 1 Calculations for Software

Calculation	Calculation(s)	Graphs
Standard Curves		
Partial sums	$SX = \sum x_i$ $SY = \sum y_i$ $SXX = \sum x_i^2$ $SYY = \sum y_i^2$ $SXY = \sum x_i y_i$ $SQX = \sum (x_i - \bar{x})^2 = N \cdot SXX - SX^2$ $SQY = \sum (y_i - \bar{y})^2 = N \cdot SYY - SY^2$ $SSXY = \sum (x_i - \bar{x})(y_i - \bar{y}) = N \cdot SXY - SX \cdot SY$ <p>where: x_i = concentration of i^{th} standard y_i = absorbance of i^{th} standard N = number of standards</p>	
Linear regression (general case)	$A = A(c)$ <p>where: A = absorbance c = concentration</p> <p>$A(c)$ is defined by an equation of the form</p> $A(c) = a_4 c^4 + a_3 c^3 + a_2 c^2 + a_1 c + a_0$ <p>where: a_0 = Y-axis intercept $a_1 \dots a_4$ = coefficients</p> <p>The coefficients are computed using the least squares method.</p>	
Linear regression through zero	$A = a_1 \cdot (c)$ <p>where: A = absorbance c = concentration a_1 = slope</p> <p>The slope is calculated as</p> $a_1 = \frac{SXY}{SXX}$ <p>This model requires:</p> <ul style="list-style-type: none"> • Slope is not equal to zero • At least one standard data point with concentration not equal to zero 	
Segmented model	<p>The segmented model requires:</p> <ul style="list-style-type: none"> • Data for at least two standard data points with different concentrations and absorbances • Slopes of all segments must be ascending (positive) OR descending (negative) 	

Appendix C - Calculations

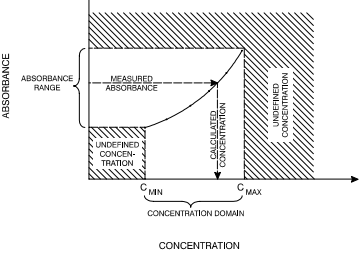
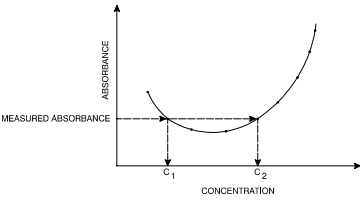
Calculation	Calculation(s)	Graphs
Validity of standard curves	<p style="text-align: center;">$A(c_1) > A(c_2)$</p> <p>for all $c_1 > c_2$</p> <p style="text-align: center;">or</p> <p style="text-align: center;">$A(c_1) < A(c_2)$</p> <p>for all $c_1 > c_2$</p> <p>where: A = absorbance c_1, c_2 = concentration</p> <p>If this is not the case, then there will be more than one solution within the specified domain, and the message "Curve cannot be used to determine unknown concentrations - it may produce ambiguous results" will appear when the curve is viewed.</p>	 <p style="text-align: center;">Valid non-linear standard curve</p>  <p style="text-align: center;">Invalid non-linear standard curve</p>
Statistics (Linear regression general case)	$\sigma = \sqrt{\frac{\sum (y_i - \bar{y}_i)^2}{N - n - 1}}$ <p>where: n = degree of polynomial</p> $r = \frac{ SSXY }{\sqrt{SQX * SQY}}$ <p>Note: The calculation for the correlation coefficient only applies to first-order linear regression curves (first-degree polynomials).</p>	
Linear regression through zero model	$\sigma = \sqrt{\frac{SYY - (a_1 * SXY)}{N - 1}}$	
Absorbance Ratio	$\frac{Abs\lambda_1}{Abs\lambda_2} \text{ or } \frac{Abs\lambda_1 - Abs_{ref}}{Abs\lambda_2 - Abs_{ref}}$	
Absorbance Difference	<p style="text-align: center;">Result = $Abs\lambda_1 * \text{factor 1} - Abs\lambda_2 * \text{factor 2}$</p> <p style="text-align: center;">or</p> <p style="text-align: center;">$(Abs\lambda_1 - Abs\lambda_{ref}) * \text{factor 1} - (Abs\lambda_2 - Abs\lambda_{ref}) * \text{factor 2}$</p>	

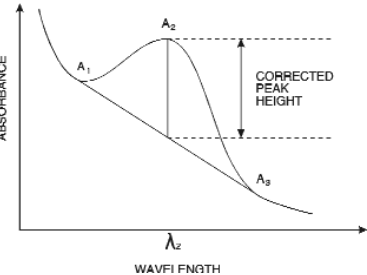
Calculation	Calculation(s)	Graphs
3-Point Net	Baseline corrected absorbance = $A_2 - \left(A_3 + \left([A_1 - A_3] * \frac{\lambda_3 - \lambda_2}{\lambda_3 - \lambda_1} \right) \right)$	 <p data-bbox="1117 659 1401 722">3-Point Net Absorbance sample curve</p>

3-Point Net2-24, 2-25, A-1, C-3
measurements2-20, 2-23

A

A/%T/C program2-8, 2-10
Absorbance & %Transmittance measurements
2-8
Absorbance Difference1-1, 2-16, 2-17,
A-1, C-2
Absorbance Ratio1-1, 2-15, C-2
Accessories4-1
Accessories, connecting & using1-3, 4-1
Analog connections1-1
Analog Output Test3-1, 3-6
Analog recorder1-1, 2-18, 3-6
Area under a curve, calculating . . .2-20, 2-23
Auto 3/Auto 62-3, 2-5, 2-9, 2-10,
2-12, 2-13, 2-15, 2-16, 2-20, 2-25, 2-27, B-2
AutoPrint2-12, B-1

B

Back panel3, 4, 1-1, 3-6, 5-2
Baseline expiration1-3, B-1
Baseline scan, collecting2-20, 2-21

C

CalculationsC-1
Calibration1-1
Cell Correction program1-4, 2-3, 2-4,
2-5, 2-8, 2-9, 2-12, 2-15, 2-16, 2-17, 2-18,
2-20, 2-24, 2-25, 2-26
Cell holders & cell holder accessories
2-4, 4-1, 4-2, 5-3
Cleaning5-1, 5-2
Concentration measurements2-6, 2-10
Concentration units2-1, 2-2, 2-6, 2-7

Custom units2-1, 2-2

D

Date and time, setting1-2

E

External computers4-3

F

Factor, entering2-7, 2-8, 2-10,
2-11, 2-26, B-1
Fuses, changing5-2

G

Glasswareii, 1-3, 2-3, 5-2
Graphical scan data, rescaling . . .2-21, 2-22

H

High Limit2-12, B-1

I

Instrument, setting up1-1
Intercept2-12, 2-13, B-1, C-1
Interface cable4-2, 4-3
Internal printer1-3
installing4-1, 4-3
setting up1-3
Test3-1
Interval Time2-17, B-1

K

Keypad5
Kinetics1-1, 2-17, 2-18, A-1
rescaling & recalculating results
2-18, 2-20

Index

L

- Language, selecting1-2, A-1
- Lock testiii, B-1
- Low LimitB-1

M

- Maintenance procedures5-1
- Manual 62-3, 2-5, 2-9,
2-11, 2-12, 2-13, 2-16, 2-17, 2-20, 2-25, 2-27
- Multiple Wavelengths2-26

N

- Noise measurement3-1, 3-4
- Number of Samples2-12, B-1

P

- Paper roll holders, installing4, 1-1, 1-3
- Paper, loading1-3
- ParametersB-1
- Passwordiii
- Peaks and valleys, labeling2-24
- Photometric accuracy3-1, 3-3, 3-4, B-1
- Printer, installing6, 4-3

R

- Replacement parts5-3

S

- Safetyi
- Sample compartment windows, cleaning .5-2
- Scan SpeedB-2
- Scanning1-1, 1-3, 1-4, 2-2, 2-3,
2-4, 2-8, 2-9, 2-12, 2-15, 2-16, 2-17, 2-18,
2-20, 2-21, 2-24, 2-25, 2-26, A-1
- Screen contrast, setting1-3

- Single Cell Platform2-5
- Single-Position Cell Holder, installing5
- Slope2-12, 2-13, B-2, C-1
- SmartStart2-2
- Software passwordiii
- SpecificationsA-1
- SPECTRONIC Standards3-2, 3-3, 3-5,
4-2, 5-3, A-1
- Standard Curve2-11
 - editing2-14
 - measuring the standards for2-12
- Standard, measuring2-7
- Standby settings, selecting1-2
- Start WavelengthB-2
- Stop WavelengthB-2
- Stray Light3-1, 3-5, A-1
- Survey Scan1-1, 2-20, 2-21, A-1

T

- Test2-5
- Tests3-5
 - Analog Output3-6
 - Internal Printer3-5
 - recalling2-9, 2-10, 2-15, 2-16,
2-17, 2-20, 2-25, 2-26
 - RS232C3-6
 - saving2-5, 2-9, 2-10, 2-13,
2-15, 2-16, 2-18, 2-21, 2-25, 2-26
- Total Run TimeB-2
 - Total Run Time2-17
- Tungsten lamp, replacing5-2

U

- Unlock test2-1, B-1
- Utility parameters, setting1-2, 1-3

W

Warrantyii
Wavelength accuracy3-1
 internal3-1
 standards3-2

Z

Z-dimensions1-2

