



# **RIPTIDE INSTINCT™ QUEST™**

## **BOW-MOUNT TROLLING MOTOR**

Owner's Manual

# INTRODUCTION

## THANK YOU

Thank you for choosing Minn Kota. We believe that you should spend more time fishing and less time positioning your boat. That's why we build the smartest, toughest, most intuitive trolling motors on the water. Every aspect of a Minn Kota trolling motor is thought out and rethought until it's good enough to bear our name. Countless hours of research and testing provide you the Minn Kota advantage that can truly take you "Anywhere. Anytime." We don't believe in shortcuts. We are Minn Kota. And we are never done helping you catch more fish.

## REGISTRATION

Remember to keep your receipt and immediately register your trolling motor on our website at [minnkota.johnsonoutdoors.com/us/register](http://minnkota.johnsonoutdoors.com/us/register).

## SERIAL NUMBER

Your Minn Kota 11-character serial number is very important. It helps to determine the specific model and year of manufacture. When contacting Consumer Service or registering your product, you will need to know your product's serial number. A duplicate copy of your serial number label has been included, which can also be entered in the One-Boat Network App for future reference.

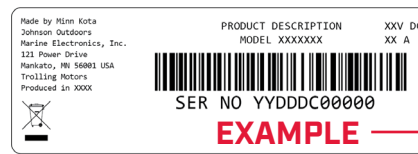
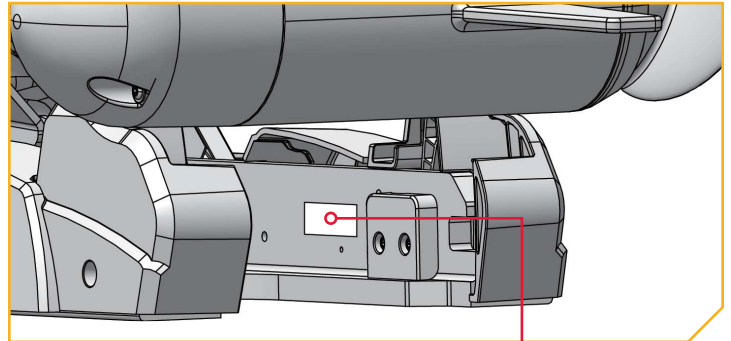

**NOTICE:** The serial number for the Riptide Instinct QUEST is located on the inside of the Mount, behind the left Motor Ramp.

## MOTOR INFORMATION (For Consumer Reference Only)

Model: \_\_\_\_\_

Serial Number: \_\_\_\_\_

Purchase Date: \_\_\_\_\_

Store Where Purchased: \_\_\_\_\_

**NOTICE:** Do not return your Minn Kota motor to your retailer. Your retailer is not authorized to repair or replace this unit. You may obtain service by: calling Minn Kota at (800) 227-6433; returning your motor to the Minn Kota Factory Service Center; sending or taking your motor to any Minn Kota authorized service center. A list of authorized service centers is available on our website at [minnkota.johnsonoutdoors.com](http://minnkota.johnsonoutdoors.com). Please include proof of purchase, serial number and purchase date for warranty service with any of the above options.

Made for iPhone® 11 and iPhone X

For updated iOS, Humminbird® and Minn Kota® compatibility, visit [minnkota.johnsonoutdoors.com](http://minnkota.johnsonoutdoors.com)



Use of the Made for Apple badge means that an accessory has been designed to connect specifically to the Apple product(s) identified in the badge, and has been certified by the developer to meet Apple performance standards. Apple is not responsible for the operation of this device or its compliance with safety and regulatory standards. iPhone is a trademark of Apple Inc., registered in the U.S. and other countries. The trademark "iPhone" is used in Japan with a license from Aiphone K.K.

Android™ is a trademark of Google LLC. The Android robot is reproduced or modified from work created and shared by Google and used according to terms described in the Creative Commons 3.0 Attribution License.

# TABLE OF CONTENTS

<b>SAFETY CONSIDERATIONS</b> .....	4	<b>MOTOR WIRING DIAGRAM</b> .....	40
<b>WARRANTY</b> .....	5	<b>USING &amp; ADJUSTING THE MOTOR</b> .....	41
<b>KNOW YOUR BOAT</b> .....	6	Mount Features.....	41
<b>FEATURES</b> .....	7	Indicator Panel.....	42
<b>INSTALLATION</b> .....	8	Stowing and Deploying the Riptide Instinct QUEST .....	43
Installation Parts List .....	8	Stowing and Deploying with the Wireless Remote .....	43
Mounting Considerations.....	9	Stowing and Deploying with the	
Tools and Resources Required.....	9	One-Boat Network (OBN) App .....	46
Installing the Riptide Instinct QUEST .....	10	Adjusting the Depth (Trim) of the Riptide Instinct QUEST .....	48
<b>BATTERY &amp; WIRING INSTALLATION</b> .....	13	Trimming with the Wireless Remote.....	48
Boat Rigging & Product Installation .....	13	Trimming with the OBN App.....	50
Conductor Gauge and Circuit Breaker Sizing Table.....	13	Motor Adjustments.....	51
Selecting the Correct Batteries .....	15	Adjusting the Lift Belt .....	51
Additional Considerations.....	14	Greasing the Tilt Shaft and Latch Pin.....	52
Connecting the Batteries in Series .....	14	Installing an External Transducer .....	53
24-Volt Systems.....	15	Emergency Stow Procedures .....	54
36-Volt Systems.....	16	Stowing from the Mount.....	54
<b>COMPLETING THE INSTALLATION</b> .....	17	Manual Stow Bypass.....	54
Verifying Power .....	17	Manual Stow Bypass Recovery.....	57
Installing the Bow-Mount Stabilizer.....	17	<b>SERVICE &amp; MAINTENANCE</b> .....	59
Powering on the Wireless Remote .....	18	Prop Replacement .....	59
Identifying Trolling Motor Features		General Maintenance .....	60
and their Associated Cables .....	19	Troubleshooting .....	60
Feature & Cable Management .....	19	For Further Troubleshooting and Repair .....	62
Advanced GPS Navigation .....	19	<b>COMPLIANCE STATEMENTS</b> .....	63
Securing the Ethernet Cable .....	24	<b>PARTS DIAGRAM &amp; PARTS LIST</b> .....	65
Installing the Prop .....	25	<b>NOTES</b> .....	81
<b>ONE-BOAT NETWORK</b> .....	26		
Optimizing the Performance of the Riptide Instinct QUEST			
with the Wireless Remote or One-Boat Network App.....	26		
One-Boat Network Adjustments .....	27		
Keel Offset.....	27		
Straight On Deploy.....	31		
Stow Orientation.....	33		
Boat Scale .....	35		
One-Boat Network Buttons .....	37		
Customizing the One-Boat Network Buttons			
on the Wireless Remote .....	37		

# SAFETY CONSIDERATIONS

Please thoroughly read the user manual. Follow all instructions and heed all safety and cautionary notices. Use of this motor is only permitted for persons that have read and understood these user instructions. Minors may use this motor only under adult supervision.

## **WARNING**

You are responsible for the safe and prudent operation of your vessel. We have designed your Minn Kota product to be an accurate and reliable tool that will enhance boat operation and improve your ability to catch fish. This product does not relieve you from the responsibility for safe operation of your boat. You must avoid hazards to navigation and always maintain a permanent watch so you can respond to situations as they develop. You must always be prepared to regain manual control of your boat. Learn to operate your Minn Kota product in an area free from hazards and obstacles.

## **WARNING**

Never run the motor out of the water, as this may result in injuries from the rotating propeller. The motor should be disconnected from the power source when it is not in use or is off the water. When connecting the power-supply cables of the motor to the battery, ensure that they are not kinked or subject to chafe and route them in such a way that persons cannot trip over them. Before using the motor make sure that the insulation of the power cables is not damaged. Disregarding these safety precautions may result in electric shorts of battery(s) and/or motor. Always disconnect motor from battery(s) before cleaning or checking the propeller. Avoid submerging the complete motor as water may enter the lower unit through control head and shaft. If the motor is used while water is present in the lower unit considerable damage to the motor can occur. This damage will not be covered by warranty.

## **WARNING**

Take care that neither you nor other persons approach the turning propeller too closely, neither with body parts nor with objects. The motor is powerful and may endanger or injure you or others. While the motor is running watch out for persons swimming and for floating objects. Persons whose ability to run the motor or whose reactions are impaired by alcohol, drugs, medication, or other substances are not permitted to use this motor. This motor is not suitable for use in strong currents. The constant noise pressure level of the motor during use is less than 70dB(A). The overall vibration level does not exceed 2,5 m/sec<sup>2</sup>.

## **WARNING**

When stowing or deploying the motor, keep fingers clear of all hinge and pivot points and all moving parts. In the event of unexpected operation, remove power leads from the battery.

## **WARNING**

It is recommended to only use Johnson Outdoors approved accessories with your Minn Kota motor. Using non-approved accessories including to mount or control your motor may cause damage, unexpected motor operation and injury. Be sure to use the product and approved accessories, including remotes, safely and in the manner directed to avoid accidental or unexpected motor operation. Keep all factory installed parts in place including motor and accessory covers, enclosures and guards.

# WARRANTY

## MINN KOTA SALTWATER/RIPTIDE TROLLING MOTORS

### Minn Kota Saltwater/Riptide Trolling Motors - Limited Lifetime Warranty On Composite Shaft And Limited Two-Year Warranty On The Entire Product

Johnson Outdoors Marine Electronics, Inc. ("JOME") extends the following limited warranty to the original retail purchaser only. Warranty coverage is not transferable.

#### Minn Kota Limited Two-Year Warranty on the Entire Product

JOME warrants to the original retail purchaser only that the purchaser's new Minn Kota saltwater trolling motor will be materially free from defects in materials and workmanship appearing within two (2) years after the date of purchase. JOME will (at its option) either repair or replace, free of charge, any parts found by JOME to be defective during the term of this warranty. Such repair, or replacement shall be the sole and exclusive liability of JOME and the sole and exclusive remedy of the purchaser for breach of this warranty.

#### Minn Kota Limited Lifetime Warranty on Composite Shaft

JOME warrants to the original retail purchaser only that the composite shaft of the purchaser's Minn Kota trolling motor will be materially free from defects in materials and workmanship appearing within the original purchaser's lifetime. JOME will provide a new composite shaft, free of charge, to replace any composite shaft found by JOME to be defective during the term of this warranty. Providing a new composite shaft shall be the sole and exclusive liability of JOME and the sole and exclusive remedy of the purchaser for breach of this warranty; and purchaser shall be responsible for installing, or for the cost of labor to install, any new composite shaft provided by JOME.

#### Exclusions and Limitations

This limited warranty does not apply to products that have been used commercially or for rental purposes. This limited warranty does not cover normal wear and tear, blemishes that do not affect the operation of the product, or damage caused by accidents, abuse, alteration, modification, shipping damages, acts of God, negligence of the user or misuse, improper or insufficient care or maintenance. **DAMAGE CAUSED BY THE USE OF OTHER REPLACEMENT PARTS NOT MEETING THE DESIGN SPECIFICATIONS OF THE ORIGINAL PARTS WILL NOT BE COVERED BY THIS LIMITED WARRANTY.** The cost of normal maintenance or replacement parts which are not in breach of the limited warranty are the responsibility of the purchaser. Prior to using products, the purchaser shall determine the suitability of the products for the intended use and assumes all related risk and liability. Any assistance JOME provides to or procures for the purchaser outside the terms, limitations or exclusions of this limited warranty will not constitute a waiver of the terms, limitations or exclusions, nor will such assistance extend or revive the warranty. JOME will not reimburse the purchaser for any expenses incurred by the purchaser in repairing, correcting or replacing any defective products or parts, except those incurred with JOME's prior written permission. **JOME'S AGGREGATE LIABILITY WITH RESPECT TO COVERED PRODUCTS IS LIMITED TO AN AMOUNT EQUAL TO THE PURCHASER'S ORIGINAL PURCHASE PRICE PAID FOR SUCH PRODUCT.**

#### Minn Kota Service Information

To obtain warranty service in the U.S., the product believed to be defective, and proof of original purchase (including the date of purchase), must be presented to a Minn Kota Authorized Service Center. Go to [minnkota.johnsonoutdoors.com/us/support/service-providers/locate](http://minnkota.johnsonoutdoors.com/us/support/service-providers/locate) to find a Minn Kota Authorized Service Center. Any charges incurred for service calls, transportation or shipping/freight to/from the Minn Kota Authorized Service Center, labor to haul out, remove, re-install or re-rig products removed for warranty service, or any other similar items are the sole and exclusive responsibility of the purchaser. Products purchased outside of the U.S. must be returned prepaid with proof of purchase (including the date of purchase and serial number) to any Authorized Minn Kota Service Center in the country of purchase. To contact Minn Kota Customer Service go to [minnkota-help.johnsonoutdoors.com/hc/en-us](http://minnkota-help.johnsonoutdoors.com/hc/en-us). Products repaired or replaced will be warranted for the remainder of the original warranty period, or for 90 days from the date of repair or replacement, whichever is longer. For any product that is returned for warranty service that JOME finds to be not covered by or not in breach of this limited warranty, there will be a billing for services rendered at the prevailing labor rate of the applicable Minn Kota Authorized Service Center and for a minimum of at least one hour.

Service Provider  
Locator



Contact Customer  
Service



**NOTICE:** Do not return your Minn Kota product to your retailer. Your retailer is not authorized to repair or replace products.

**NOTICE:** THERE ARE NO EXPRESS WARRANTIES OTHER THAN THESE LIMITED WARRANTIES. IN NO EVENT SHALL ANY IMPLIED WARRANTIES INCLUDING ANY IMPLIED WARRANTIES OF MERCHANTABILITY OR FITNESS FOR PARTICULAR PURPOSE, EXTEND BEYOND THE DURATION OF THE RELEVANT EXPRESS LIMITED WARRANTY. IN NO EVENT SHALL JOME BE LIABLE FOR PUNITIVE, INDIRECT, INCIDENTAL, CONSEQUENTIAL OR SPECIAL DAMAGES. Without limiting the foregoing, JOME assumes no responsibility for loss of use of product, loss of time, inconvenience or other damage.

Some states do not allow limitations on how long an implied warranty lasts or the exclusion or limitation of incidental or consequential damages, so the above limitations and/or exclusions may not apply to you. This warranty gives you specific legal rights and you may also have other legal rights which vary from state to state.

# KNOW YOUR BOAT

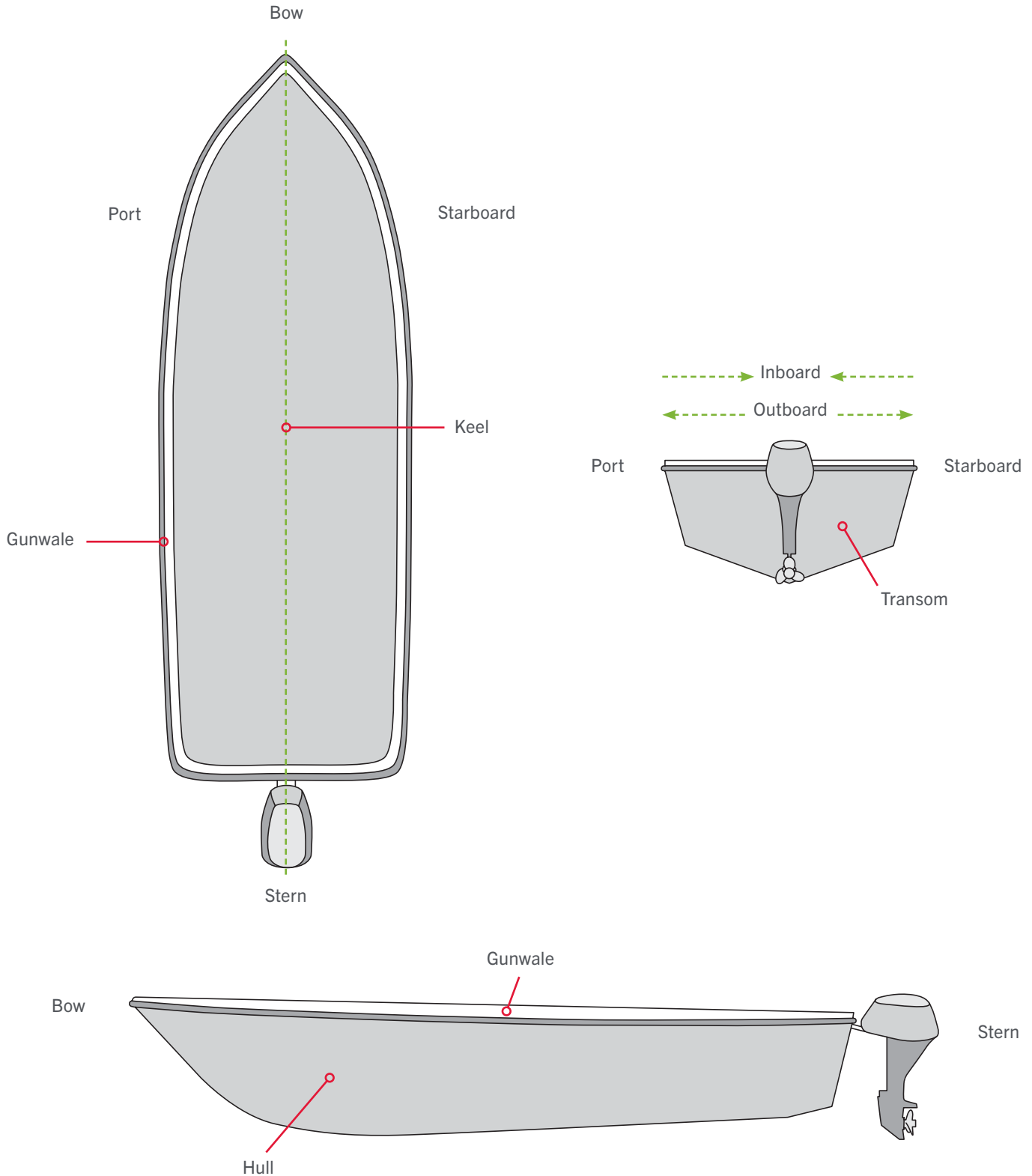

# FEATURES

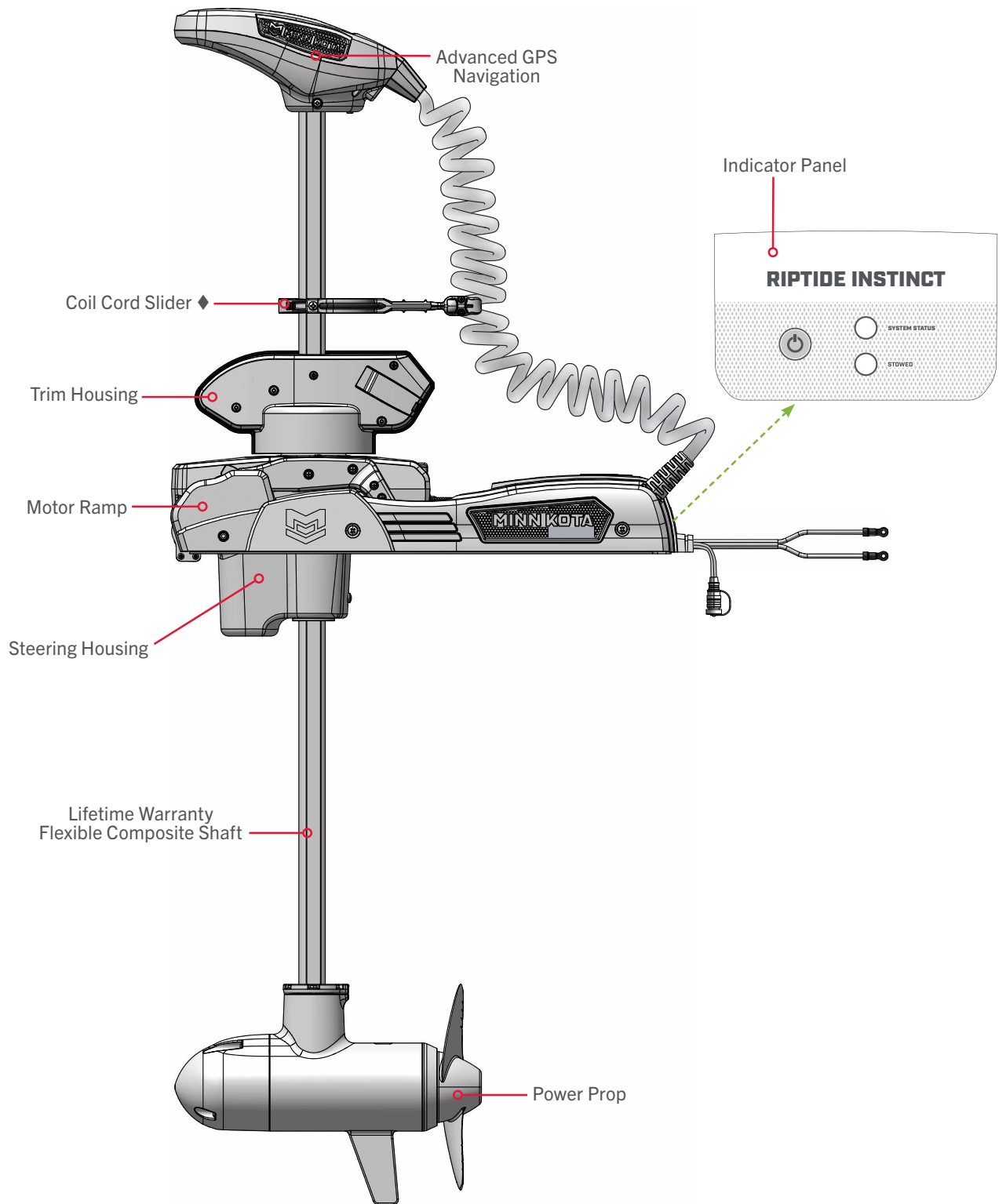

◆ Only on models with a 72", 87", or 100" shaft length.

**NOTICE:** Specifications subject to change without notice. This diagram is for reference only and may differ from your actual motor.

# INSTALLATION

## INSTALLING THE RIPTIDE INSTINCT QUEST

Your new Riptide Instinct QUEST comes with everything you'll need to install it directly to the boat. The motor can be mounted directly to the bow or coupled with a Minn Kota quick release bracket for ease of mounting and removal. For compatible quick release brackets and to locate your nearest dealer, visit [minnkota.johnsonoutdoors.com](http://minnkota.johnsonoutdoors.com). To install the motor directly to the boat, follow the instructions provided in this manual. Please review the parts list, mounting considerations and tools needed for installation prior to getting started. For additional product support, visit [minnkota.johnsonoutdoors.com](http://minnkota.johnsonoutdoors.com).

### INSTALLATION PARTS LIST

Item / Assembly	Part #	Description	Qty.
A (Includes 1-5)	2994948	BAG ASM, INSTINCT, T3 BL HDW	1
1	2323440	SCREW-3/8-16 X 2 1/2 HHCS SS	6
2	2383122	NUT 3/8-16 NYLON INST LOCKNUT	6
3	2321710	WASHER, RUBBER MOUNT	6
4	2371796	BACKUP BAR 3/16 X 1 X 2	6
5	2378608	ANTI SEIZE TUBE, 4CC, TALON	1
6	✘	MOTOR ASSEMBLY	1
7	2390802	LANYARD w/CARABINER IP RMT U2	1
B	411690-1	TROLLING MOTOR REMOTE	1
C	2992371	STABILIZER, BWMT ES TM ASM *72"**87"**100"*	1
D (Includes 8)	2994955	BAG ASM, MKA-60 STABILIZER *72"**87"**100"*	1
8	2383475	SCREW-#8-18x1½L SELF DRILL SS *72"**87"**100"*	4
9	2321170	PROP, POWER REAMED	1
E (Includes 10-12)	2992604	BAG ASSM, PROP HARDWARE	1
10	2091701	WASHER-PROP (LARGE) MAX101	1
11	2093101	NUT-PROP, NYLOC, LG, MX101 3/8 SS	1
12	2262659	PIN-DRIVE 1" X 3/16 SS 17-4	1
13	490637-4	CABLE, ETH, M12-M12, BRAID, 30'	1
14	490380-1	CABLE, ETHERNET PIGTAIL-700 HD	1
15	2206301	TIE WRAP, LOW PROFILE 8"	1
▲	2207127	MANUAL, INSTINCT	1
▲	2207128	MANUAL, INSTL GD, INSTINCT	1
▲	2207126	QK REF GUIDE, ULT Q/INST Q	1
▲	2397110	MANUAL, WIRELESS REMOTE	1
▲	2397115	GUIDE-QCK REFERENCE IP 4.0	1
▲	2294950	INSTRUCTIONS, OBN & REMOTE PAIR	1
▲	2207130	BRUSHLESS QS SETUP GUIDE	1
▲	2297165	MANUAL-DISCLAIMER, DOWNLOAD INFO	1
▲	2377179	INSTR. SHEET, MKA-60 STBLZR *72"**87"**100"*	1

▲ Not shown on Parts Diagram.

✘ This part is included in an assembly and cannot be ordered individually.

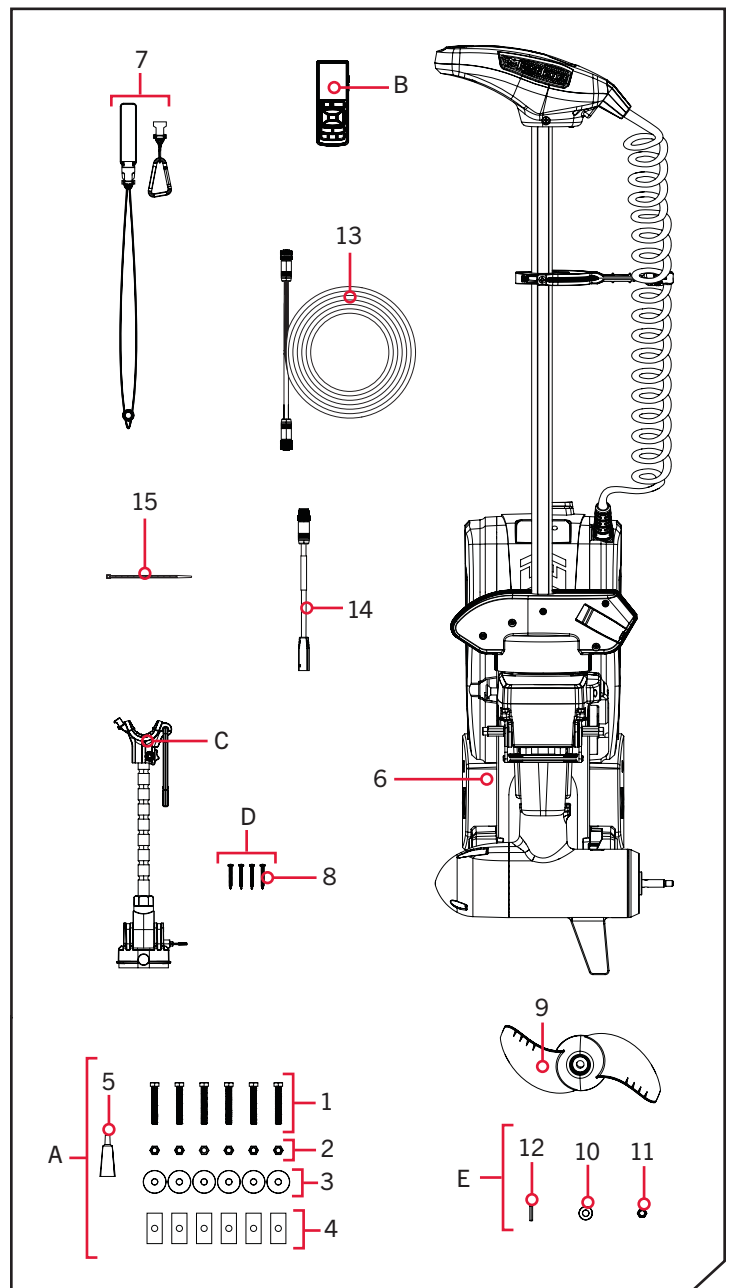

# MOUNTING CONSIDERATIONS



## MOUNTING CONSIDERATIONS

It is recommended that the motor be mounted as close to the centerline or keel of the boat as possible. Make sure the area under the mounting location is clear to drill holes and install hardware. The mounting surface for the Riptide Instinct QUEST must be flat. Rubber washers can be used to shim the base extrusion flat before hardware is tightened.

The motor must not encounter any obstructions as it is lowered into the water or raised into the boat when stowed and deployed. When stowed, ensure that there is enough room for the Shaft and Control Head and that they do not extend off the side of the boat.



View accessories available for your trolling motor at [minnkota.johnsonoutdoors.com](http://minnkota.johnsonoutdoors.com).

All six mounting holes must be used when securing the Riptide Instinct QUEST to the boat deck. If the desired mounting location does not allow for all six mounting holes and mounting bolts, a Boat Deck Reinforcement Kit (1854058) should be used or a new mounting location selected. Consider a quick release bracket with the installation of your motor.

Mounting options for the Riptide Instinct QUEST include:

1. Installing the motor directly to the boat deck
2. Mounting the motor with an MKA-58 Boat Deck Reinforcement Kit (1854058)
3. Mounting the motor with an MKA-56/RTA-55 composite quick release bracket (1854056 - black/1854055 - white) or an MKA-57 sliding quick release bracket (1854057)
4. Combining an MKA-58 Boat Deck Reinforcement Kit and an MKA-56/RTA-55 Quick Release Bracket with the Riptide Instinct QUEST

When mounting the Riptide Instinct QUEST directly to the boat, follow the installation instructions outlined in this manual. If an accessory bracket will be used to mount the Riptide Instinct QUEST, follow the installation instructions provided with the mounting accessory. To view a list of compatible accessories, visit [minnkota.johnsonoutdoors.com](http://minnkota.johnsonoutdoors.com).

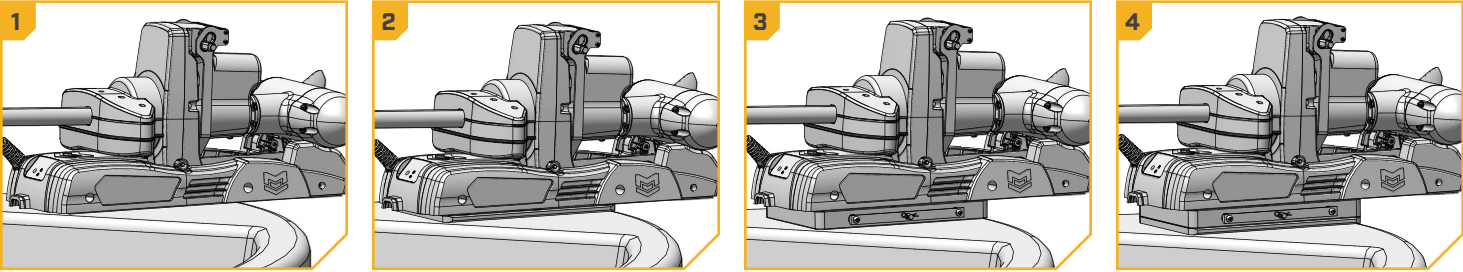

## TOOLS AND RESOURCES REQUIRED

- #3 Phillips Screwdriver
- Drill
- 3/8" Drill Bit
- Awl or similar marking tool
- 9/16" Open/Box End Wrench
- 9/16" Deep Well Socket
- A second person to help with the installation



# INSTALLING THE RIPTIDE INSTINCT QUEST

## INSTALLATION >

### INSTALLING THE RIPTIDE INSTINCT QUEST

1

#### ITEM(S) NEEDED

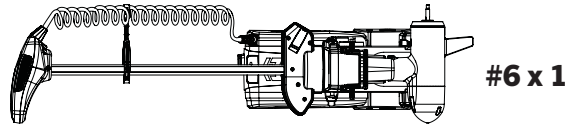

- a. Place the trolling motor (Item #6) on an elevated, level surface, such as a workbench or the tailgate of a pickup. The motor, as removed from the box, should be in the stowed position.
- b. Make sure that the Power Cables from the battery are disconnected or that the breaker, if equipped, is “off.”

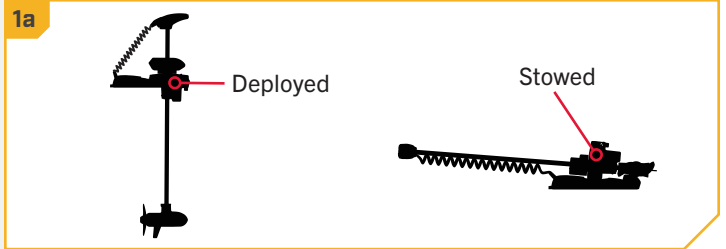

## WARNING

Make sure the motor is on a level surface and is not connected to a power source.

**NOTICE:** The trolling motor weighs up to 90lb. Minn Kota recommends having a second person help with the installation.

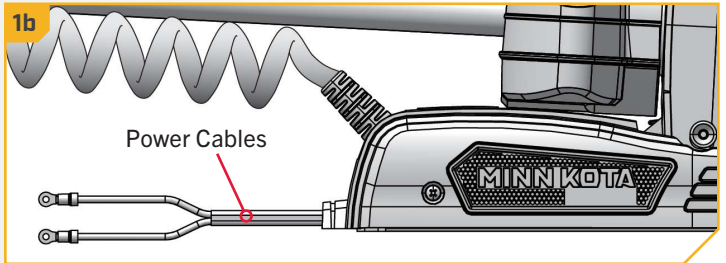

2

- c. Remove the four Sideplate Screws using a #3 Phillips Screwdriver. Two of these screws will be located on each side of the mount.
- d. Remove the Right Sideplate and the Left Sideplate to expose the six mounting holes in the Base Extrusion.

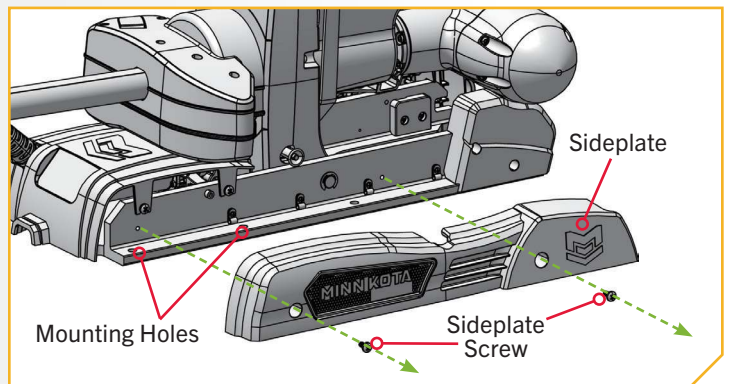

# INSTALLING THE RIPTIDE INSTINCT QUEST

3

- e. Review the mounting considerations at the beginning of the Installation section for proper clearance. Place the motor on the bow of the boat at the intended mounting location, as close to the centerline or keel as possible. Ensure there is enough room for the Shaft and Control Head and that they do not extend off the side of the boat. The motor can be installed on either the Port or Starboard side of the bow, based on personal preference.
- f. Position the motor so that the Slot in the Base Extrusion is positioned beyond the boat Gunwale. For proper clearance, the entire Slot must be visible beyond the Gunwale. When the motor is deployed, there must be a minimum required distance of 1½" between the Gunwale and the bottom of the Steering Housing and Shaft.

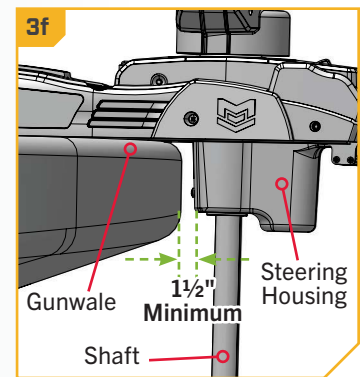
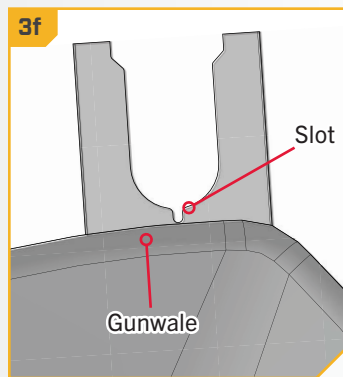
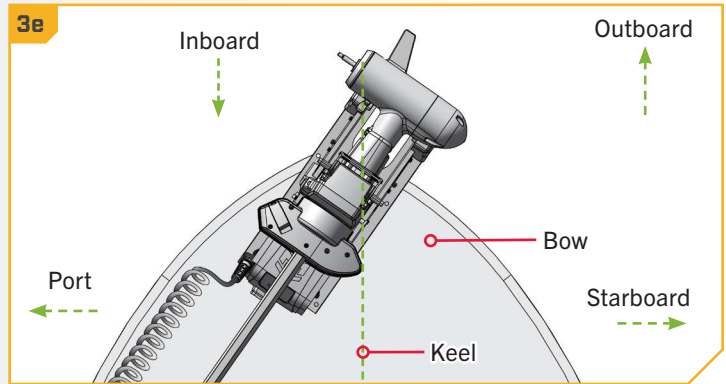

## CAUTION

Illustrations are for reference only. Do not deploy the motor until it is fully mounted to the boat. Deploying the motor before it is mounted to the boat may cause injury.

- g. When mounting the Riptide Instinct QUEST, all six mounting holes must be used. If the desired mounting location does not allow for all six mounting holes, a Boat Deck Reinforcement Kit (1854058) should be used or a new mounting location selected.

4

- h. With the motor at the intended mounting location, take an Awl or similar tool and mark all six mounting holes in the Base Extrusion.
- i. Slide the motor aside to drill the mounting holes. Drill through the boat deck using a Drill and a 3/8" Drill Bit on all six marked locations.
- j. Reposition the motor over the drilled holes to install mounting hardware.

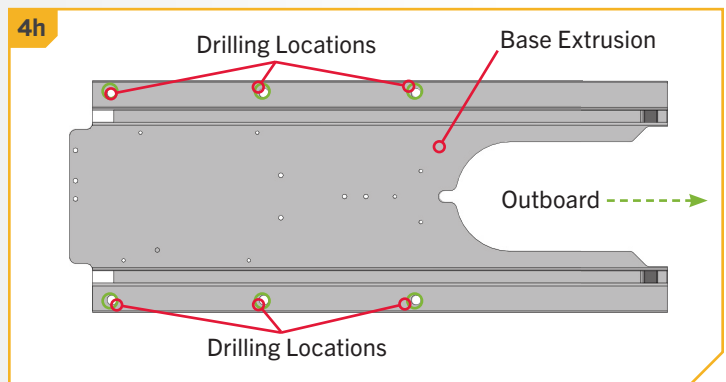

**NOTICE:** New mounting holes are required when upgrading from an Ulterra to a Riptide Instinct QUEST. New mounting holes will accommodate the higher thrust motor and ensure the installation is secure.

**NOTICE:** The mounting surface for the Riptide Instinct QUEST must be flat. Rubber Washers can be used to shim the Base Extrusion flat before hardware is tightened.

# INSTALLING THE RIPTIDE INSTINCT QUEST

5

## ITEM(S) NEEDED



#1 x 6



#2 x 6



#3 x 6



#4 x 6



#5 x 1

**NOTICE:** To prevent seizing of the stainless steel hardware, do not use high-speed installation tools. Wetting the screws or applying an anti-seize (Item #5) may help prevent seizing.

- k. Take six Hex Head Cap Screws (Item #1) and apply anti-seize (Item #5) to each Screw. Insert the Screws through the Base Extrusion and into each of the drilled locations. If Rubber Washers (Item #3) are used, the Rubber Washers should sit between the Base Extrusion and boat deck.
- l. Place a Backup Bar (Item #4) and then a Nylock Nut (Item #2) on the end of each Screw. Tighten with a 9/16" Box End or Open End Wrench. Make sure all hardware is secure.

**NOTICE:** Use extra care to avoid pinching and damaging the sensor wires that run alongside the Base Extrusion when installing and tightening the mounting hardware.

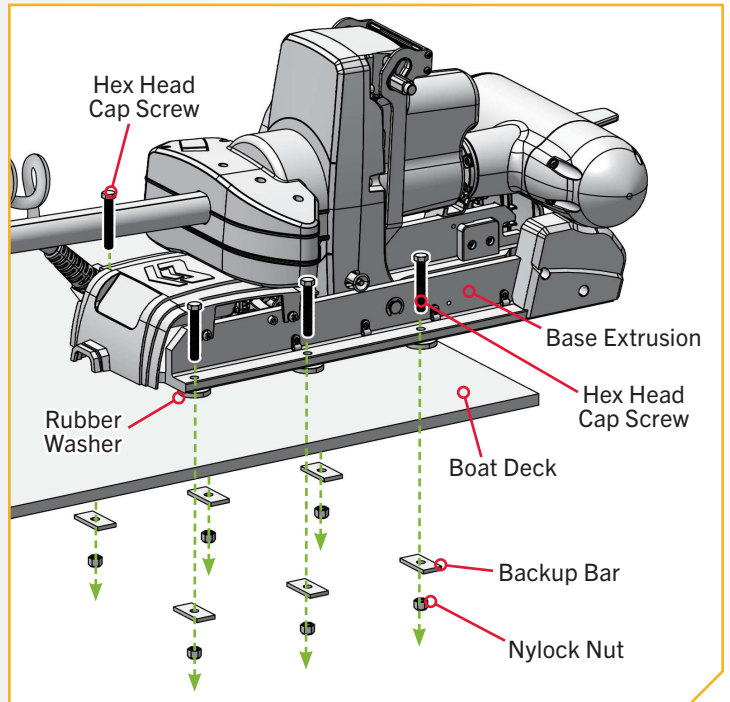

6

- m. Replace the Right Sideplate and Left Sideplate. Replace the four Sideplate Screws using a #3 Phillips Screwdriver. Two of these screws will be located on each side of the mount.

**NOTICE:** When reinstalling the Sideplates, use care to avoid pinching the sensor wires that run alongside the Base Extrusion.

**NOTICE:** Ensure that the area between the Mount and Steering Housing is clean and free of debris and that no installation hardware has fallen in. The Mount contains a Stow Pad that contacts the Steering Housing when stowed. The motor cannot stow securely if an obstruction is present on the Stow Pad.

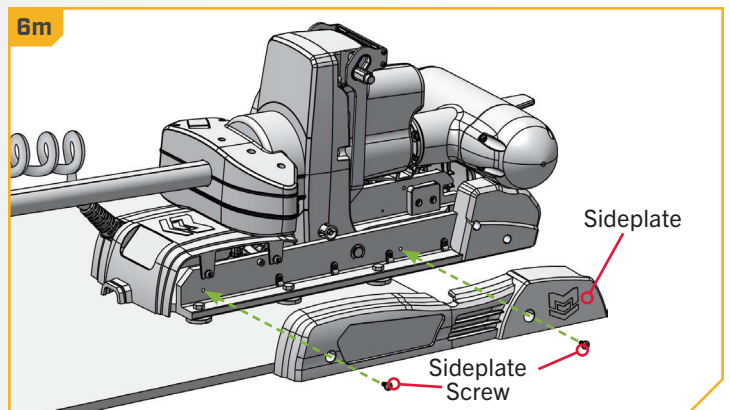

# BATTERY & WIRING INSTALLATION

## BOAT RIGGING & PRODUCT INSTALLATION

For safety and compliance reasons, we recommend that you follow American Boat and Yacht Council (ABYC) standards when rigging your boat. Altering boat wiring should be completed by a qualified marine technician. The following specifications are for general guidelines only:

### CAUTION

These guidelines apply to general rigging to support your Minn Kota motor. Powering multiple motors or additional electrical devices from the same power circuit may impact the recommended conductor gauge and circuit breaker size. If you are using wire longer than that provided with your unit, follow the conductor gauge and circuit breaker sizing table below. If your wire extension length is more than 25 feet, we recommend that you contact a qualified marine technician.

### CAUTION

**An over-current protection device (circuit breaker or fuse) must be used.** Coast Guard requirements dictate that each ungrounded current-carrying conductor must be protected by a manually reset, trip-free circuit breaker or fuse. The type (voltage and current rating) of the fuse or circuit breaker must be sized accordingly to the trolling motor used. The table below gives recommended guidelines for circuit breaker sizing.

## CONDUCTOR GAUGE AND CIRCUIT BREAKER SIZING TABLE

This conductor and circuit breaker sizing table is only valid for the following assumptions:

1. No more than 2 conductors are bundled together inside of a sheath or conduit outside of engine spaces.
2. Each conductor has 105° C temp rated insulation.
3. No more than 3% voltage drop allowed at full motor power based on published product power requirements.

Motor Thrust / Model	Max Amp Draw	Circuit Breaker		Wire Extension Length				
		Amps	Minimum	5 feet	10 feet	15 feet	20 feet	25 feet
QUEST 24V	60	60 Amp	24 VDC	6 AWG	6 AWG	4 AWG	4 AWG	2 AWG
QUEST 36V	60	60 Amp	36 VDC	6 AWG	6 AWG	6 AWG	6 AWG	4 AWG

**NOTICE:** Wire Extension Length refers to the distance from the batteries to the trolling motor leads. Consult website for available thrust options.

Reference

United States Code of Federal Regulations: 33 CFR 183 – Boats and Associated Equipment ABYC E-11: AC and DC Electrical Systems on Boats

# SELECTING THE CORRECT BATTERIES



## SELECTING THE CORRECT BATTERIES

QUEST series motors will operate with any deep cycle marine 12, 24 or 36-volt battery/batteries and have been optimized for use with LiFePO<sub>4</sub> lithium-ion battery cells. Lithium-ion batteries maintain higher voltages for more extended periods than lead-acid batteries and will provide the best performance in powering the trolling motor.

QUEST series trolling motors may also be powered with lead-acid (flooded, AGM, or GEL) deep-cycle marine 12-volt battery/batteries. For best results, Minn Kota recommends using a deep-cycle marine battery with rating outlined in the "Deep Cycle Amp-Hour Rating" table. Maintain lead-acid batteries at full charge. Proper care will ensure battery power when needed and significantly improve battery life. Failure to recharge lead-acid batteries (within 12-24 hours) is the leading cause of premature battery failure. Use a multi-stage charger to avoid overcharging. When using Lithium Ion batteries, manufacturers may recommend storing in a semi-charged state and charging fully prior to use.

Deep Cycle Amp-Hour Rating			
Run Time	Voltage	Group Size	Amp-Hour
GOOD	12	24	70-85
BETTER	12	27	85-110
BEST	12	31	95-125

If using a crank battery to start a gasoline outboard, Minn Kota recommends using a separate battery/batteries for your Minn Kota trolling motor. Always check with the battery manufacturer for specific maintenance, care and storage instructions. Minn Kota also offers a wide selection of chargers to fit your charging needs. For more information on battery selection, rigging, and chargers, please visit [minnkota.johnsonoutdoors.com](http://minnkota.johnsonoutdoors.com).

### **WARNING**

Never connect the (+) and the (-) terminals of the same battery together. Take care that no metal object can fall onto the battery and short the terminals. This would immediately lead to a short and extreme fire danger.

### **CAUTION**

Refer to "Conductor Gauge and Circuit Breaker Sizing Table" in the previous section to find the appropriate circuit breaker or fuse for your motor. For motors requiring a 60-amp breaker, the Minn Kota MKR-27 60-amp circuit breaker (1865115) is recommended.

### **CAUTION**

Please read the following information before connecting your motor to your batteries in order to avoid damaging your motor and/or voiding your warranty.

## ADDITIONAL CONSIDERATIONS

### › Using DC or Alternator Chargers

Your Minn Kota trolling motor may be designed with an internal bonding wire to reduce sonar interference. Most alternator charging systems do not account for this bonding wire, and connect the negative posts of the trolling motor batteries to the negative posts of the crank/starting battery. These external connections can damage connected electronics and the electrical system of your trolling motor, voiding your warranty. Review your charger's manual carefully or consult the manufacturer prior to use to ensure your charger is compatible.

Minn Kota recommends using Minn Kota brand chargers to recharge the batteries connected to your Minn Kota trolling motor, as they have been engineered to work with motors that include a bonding wire. Learn more about Minn Kota chargers online at [minnkota.johnsonoutdoors.com](http://minnkota.johnsonoutdoors.com).

# CONNECTING THE BATTERIES IN SERIES

## › Additional Accessories Connected to Trolling Motor Batteries

Significant damage to your Minn Kota motor, your boat electronics, and your boat can occur if incorrect connections are made between your trolling motor batteries and other battery systems. Minn Kota recommends using an exclusive battery system for your trolling motor. Where possible, accessories should be connected to a separate battery system. Radios and sonar units should not be connected to any trolling motor battery systems as interference from the trolling motor is unavoidable. If connecting any additional accessories to any trolling motor battery system, or making connections between the trolling motor batteries and other battery systems on the boat, be sure to carefully observe the information below.

The negative (-) connection must be connected to the negative terminal of the same battery that the trolling motor negative lead connects to. In the diagrams below this battery is labeled “Low Side” Battery. Connecting to any other trolling motor battery will input positive voltage into the “ground” of that accessory, which can cause excess corrosion. Any damage caused by incorrect connections between battery systems will not be covered under warranty.

## › Automatic Jump Start Systems and Selector Switches

Automatic jump start systems and selector switches tie the negatives of the connected batteries together. Connecting these systems to the “High Side” Battery or “Middle” Battery in the diagrams below and will cause significant damage to your trolling motor and electronics. The only trolling motor battery that is safe to connect to one of these systems is the “Low Side” Battery.

## CONNECTING THE BATTERIES IN SERIES (IF REQUIRED FOR YOUR MOTOR)

### › 24-Volt Systems

Two 12-volt batteries are required. The batteries must be wired in series, only as directed in the wiring diagram, to provide 24 volts.

1. Make sure that the motor is switched off (speed selector on “0”).
2. Connect a connector cable to the positive (+) terminal of battery 1 and to the negative (-) terminal of battery 2.
3. Connect positive (+) red motor lead to positive (+) terminal on battery 2.
4. Connect negative (-) black motor lead to negative (-) terminal of battery 1.

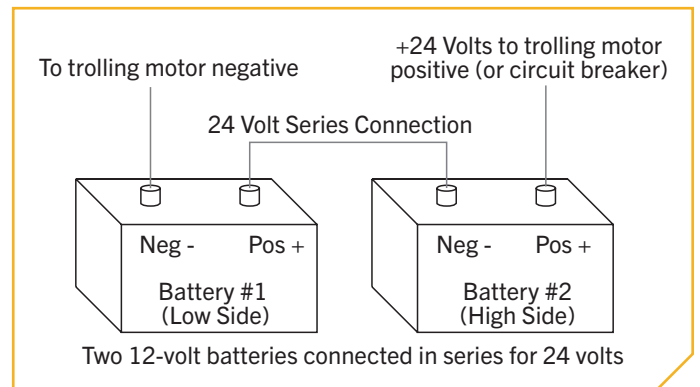

## WARNING

For safety reasons do not switch the motor on until the propeller is in the water. If installing a leadwire plug, observe proper polarity and follow instructions in your boat owner’s manual.

## WARNING

- For safety reasons, disconnect the motor from the battery or batteries when the motor is not in use or while the battery/batteries are being charged.
- Improper wiring of 24/36 volt systems could cause battery explosion.
- Keep leadwire wing nut connections tight and solid to battery terminals.
- Locate battery in a ventilated compartment.

# CONNECTING THE BATTERIES IN SERIES

## 36-Volt Systems

Three 12-volt batteries are required. The batteries must be wired in series, only as directed in the wiring diagram, to provide 36 volts.

1. Make sure that the motor is switched off (speed selector on "0").
2. Connect a connector cable to the positive (+) terminal of battery 1 and to the negative (-) terminal of battery 2 and another connector cable from the positive (+) terminal of battery 2 to the negative (-) terminal of battery 3.
3. Connect positive (+) red motor lead to positive (+) terminal on battery 3.
4. Connect negative (-) black motor lead to negative (-) terminal of battery 1.

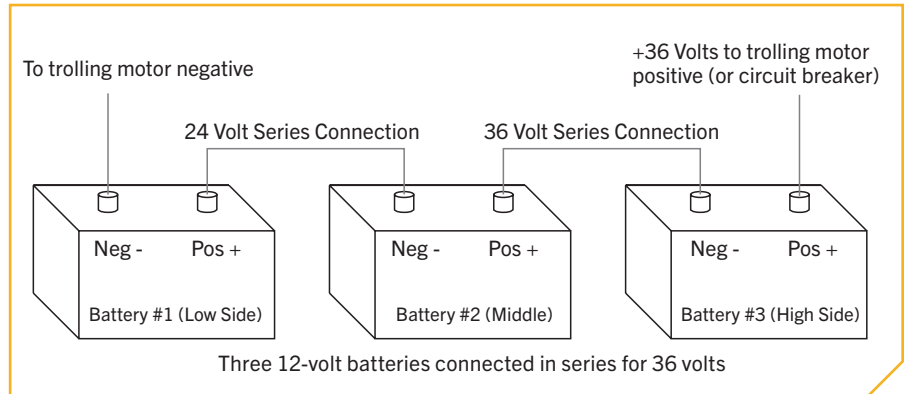

### WARNING

For safety reasons, do not switch the motor on until the propeller is in the water. If installing a leadwire plug, observe proper polarity and follow instructions in your boat owner's manual.

### WARNING

- For safety reasons, disconnect the motor from the battery or batteries when the motor is not in use or while the battery/batteries are being charged.
- Improper wiring of 24/36 volt systems could cause battery explosion.
- Keep leadwire wing nut connections tight and solid to battery terminals.
- Locate battery in a ventilated compartment.

# COMPLETING THE INSTALLATION

## COMPLETING THE RIPTIDE INSTINCT QUEST INSTALLATION



The Riptide Instinct QUEST is an advanced trolling motor. To maximize its performance, mechanical and electrical systems should be set and calibrated to fit every user's installation. This portion of the installation will cover how to verify power, install the Bow-mount Stabilizer, and more. The installation will conclude with connecting the Ethernet Cable and setting motor preferences for ease of use. Minn Kota recommends connecting the trolling motor to the One-Boat Network app to assist in these steps. Find more information in the One-Boat Network App document included with the trolling motor or the One-Boat Network Owner's Manual found online at [minnkota.johnsonoutdoors.com](http://minnkota.johnsonoutdoors.com).

### COMPLETING THE INSTALLATION >

#### > Verifying Power

Each time the trolling motor is powered "on," the control board will auto-detect the power supplied from the battery system and adjust the thrust output based on a 24V or 36V battery system. To verify power to the trolling motor, connect the Riptide Instinct QUEST to power. At specific points in the installation, power will be disconnected or turned "off" to ensure a safe environment for installation.

1

- a. Locate the Indicator Panel at the front of the Mount. Power on the trolling motor by pressing the Power  button on the Indicator Panel. When the trolling motor is on, the System Status  LED will be blue.
- b. To turn the motor "off," press and release the Power button. When the Motor is powered off, the System Status  LED will not be illuminated.

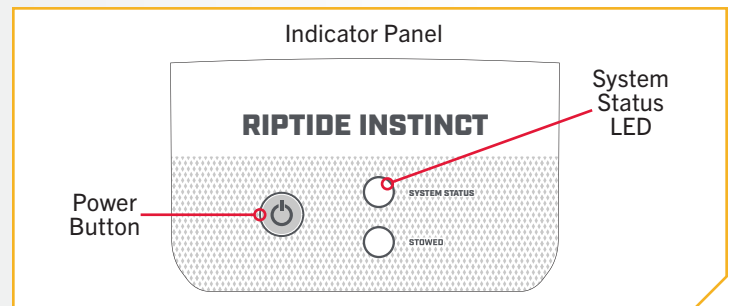

**NOTICE:** In instances where the trolling motor is updating, the System Status LED will flash blue while the update is performed. Once the update is complete, the system will self-reboot and perform the normal start-up sequence. If a standard power-up sequence is not experienced, please see the Troubleshooting section of the Riptide Instinct QUEST Owner's Manual to identify any errors. To learn more about software updates, please see the Owner's Manual for the One-Boat Network or Advanced GPS Navigation Wireless Remote.

#### > Installing the Bow-Mount Stabilizer

Riptide Instinct QUEST motors with a 72", 87", or 100" shaft length come with an MKA-60 Bow-Mount Stabilizer Kit (Assembly #C and #D). This accessory stabilizes the shaft and control head when the motor is stowed for transport. Motors with shaft lengths under 72" may purchase the MKA-60 separately as an optional accessory (1862060). For instructions on installing the MKA-60 to the Riptide Instinct QUEST, refer to the document provided with the Bow-Mount Stabilizer Kit.

# POWERING ON THE WIRELESS REMOTE

## › Powering on the Wireless Remote

1

### ITEM(S) NEEDED



#B x 1



#7 x 1

- Power on the trolling motor.
- To turn on the Wireless Remote (Assembly #B), press and hold the Power button on the side of the Remote.
- A message will appear on the display screen. Read the disclaimer, then press the Steer Right button to select "I Agree."
- The content on the display screen will populate. Remote functions to manually control the motor are now active, including Speed Up, Speed Down, Steer Left, Steer Right, and Prop On/Off.
- When the Advanced GPS Navigation system has obtained a minimum GPS signal strength of one bar, all remaining functions will become available.

**NOTICE:** Attaching the Lanyard (Item #7) to the Wireless Remote is optional.

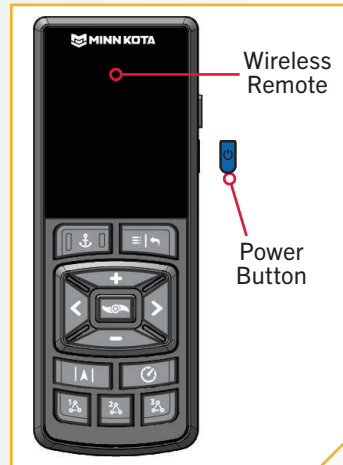

**Warning!**

You are responsible for the safe and prudent operation of your boat. This product does not relieve you from the responsibility for safe operation of your boat.

**I Agree** >

**NOTICE:** The Wireless Remote comes from the factory paired to the Riptide Instinct QUEST.

**NOTICE:** A Remote Cradle accessory (1866675) can be purchased for mounting the Wireless Remote or attaching the Remote to a belt clip.

# IDENTIFYING TROLLING MOTOR FEATURES AND THEIR ASSOCIATED CABLES

## IDENTIFYING TROLLING MOTOR FEATURES AND THEIR ASSOCIATED CABLES

### › Feature & Cable Identification

The Riptide Instinct QUEST is pre-installed with **Advanced GPS Navigation** - including the ability to connect via Ethernet to a Humminbird fish finder. One Eight-Pin Advanced GPS Ethernet Connector will exit the base of the Control Head and rest just below the Control Head next to the Coil Cord.

If the Advanced GPS Navigation on the trolling motor will be used with a fish finder, an Ethernet Cable may be attached to the Advanced GPS Ethernet Connector. See the “Advanced GPS Navigation” and “Securing the Ethernet Cable” sections of this document for details on how to install the Advanced GPS Ethernet Connector to a Humminbird fish finder.

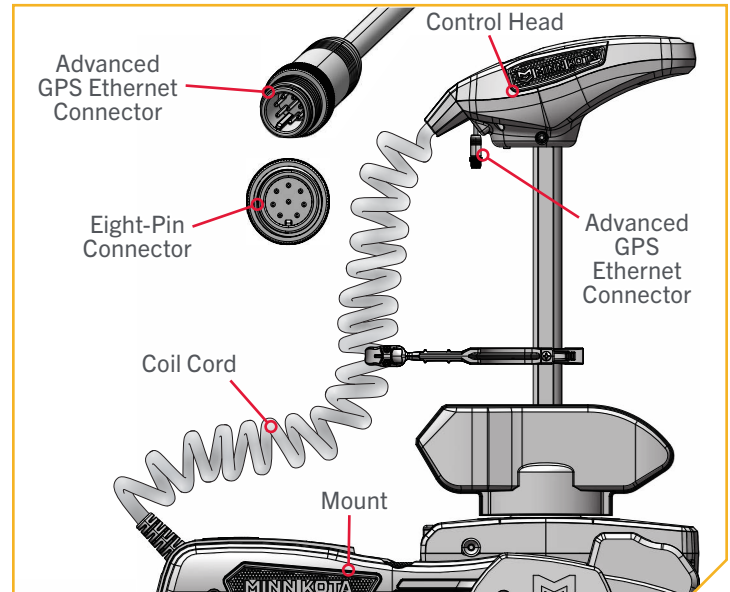

#### Advanced GPS Navigation

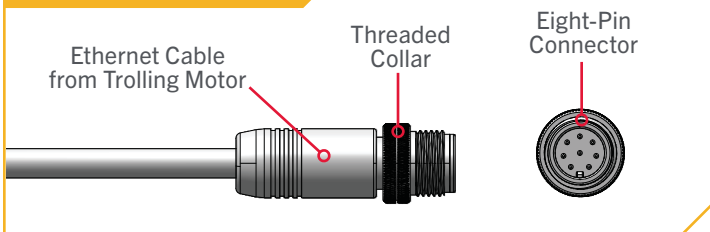

### › Feature & Cable Management

#### ADVANCED GPS NAVIGATION ›

Your Minn Kota trolling motor and Humminbird fish finder communicate with each other to change the way you fish. Advanced GPS Navigation offers a large array of features including controlling speed, steering, Spot-Lock, and the ability to record and retrace paths on the water, all at your fingertips. To learn more about the GPS capabilities available with your new motor, please refer to the Advanced GPS Navigation Owner's Manual by visiting [minnkota.johnsonoutdoors.com](http://minnkota.johnsonoutdoors.com).

The Wireless Remote and GPS controller make up the Advanced GPS Navigation system. A Wireless Remote comes paired to the controller from the factory. The GPS controller contains a very sensitive compass and is where all GPS satellite and remote signals are received. The GPS controller is located in the trolling motor Control Head and may be connected to a fish finder from a connection cable that exits the Control Head. If the Advanced GPS Navigation system will be used with a fish finder, the Ethernet link between the trolling motor and the fish finder should be connected.

# ADVANCED GPS NAVIGATION

## › Considerations for Connecting and Routing Advanced GPS Navigation

Advanced GPS Navigation is pre-installed on your trolling motor. One eight-pin Advanced GPS Ethernet Connector will exit the base of the Control Head and rest just below the Control Head next to the Coil Cord. If the Advanced GPS Navigation on the trolling motor will be used with a fish finder, an Ethernet Cable will need to be attached to the Advanced GPS Ethernet Connector below the Control Head. Consider the distance between the trolling motor and the fish finder to determine how to complete the Ethernet connection.

**ETHERNET CABLES** - Minn Kota provides one 30 ft Ethernet cable with every trolling motor equipped with Advanced GPS Navigation. The 30 ft Ethernet cable will accommodate a standard Ethernet connection for most installations to a Humminbird fish finder and is "Apex and Solix Ready."

**HUMMINBIRD HELIX ADAPTER CABLES** - Minn Kota provides one Helix Adapter Cable (AS EC QDE - Ethernet Adapter Cable - 720074-1) with every trolling motor equipped with Advanced GPS Navigation. If the Ethernet connection is being made between the trolling motor and any Humminbird® Helix fish finder, the Helix Adapter Cable should be used. The Helix Adapter Cable directly connects the Ethernet Cable to a Helix fish finder.

**ETHERNET EXTENSION CABLES** - If the 30 ft Ethernet cable provided with your trolling motor with Advanced GPS Navigation is not long enough to reach the fish finder, an Ethernet Extension cable should be used. The Ethernet Extension cable is available from [humminbird.johnsonoutdoors.com](http://humminbird.johnsonoutdoors.com) and is available in a 30 ft length (AS ECX 30E - 30' Ethernet Extension Cable - 760025-1). The Ethernet Extension Cable will plug directly into any length of Ethernet cable.

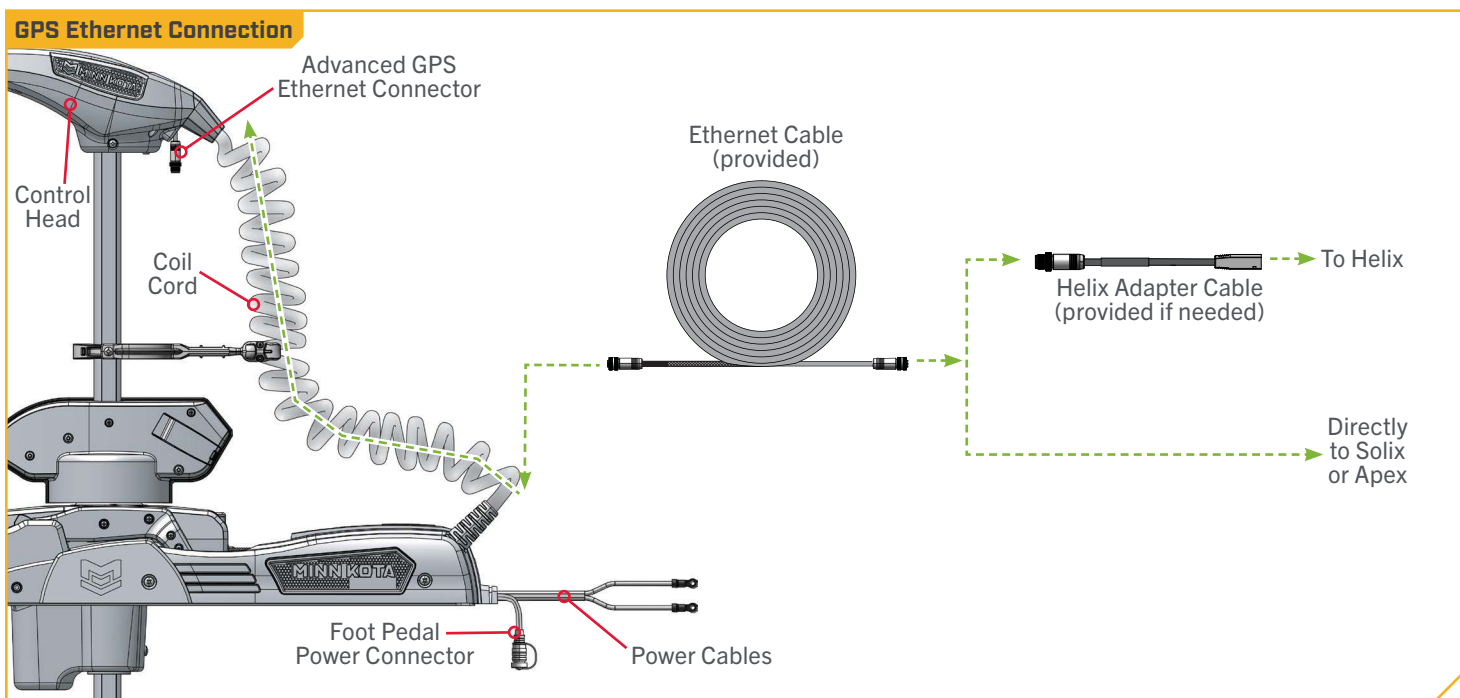

**NOTICE:** Minn Kota recommends routing the Ethernet Cable or Ethernet Extension Cable through the Coil Cord when making the Ethernet connection. The cable will be installed from the Mount to the Control Head through the Coil Cord. Bypassing the Coil Cord when routing the Ethernet Cable or Ethernet Extension Cable is not recommended.

## ⚠ CAUTION

Failure to follow the recommended wire routing for installed features, if equipped, may cause damage to the product and void your product warranty. Route cables away from pinch points or other areas that may cause them to bend in sharp angles. Routing the cables in any way other than directed may cause damage to the cables by being pinched or severed.

## 1

### ITEM(S) NEEDED

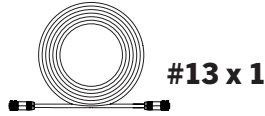

**NOTICE:** Your fish finder should be turned off until this procedure is complete.

**NOTICE:** For instructions on deploying the motor, see the “Stowing and Deploying the Riptide Instinct QUEST” section of this manual.

- a. Place the motor in the deployed position.
- b. Locate the Eight-Pin Advanced GPS Ethernet Connector below the Control Head. The Advanced GPS Ethernet Connector will exit the base of the Control Head and will rest just below the Control Head next to the Coil Cord.
- c. Identify the keyed Receptacle on the Ethernet Cable (Item #13). It will be keyed to fit with the Eight-Pin Advanced GPS Ethernet Connector below the Control Head.

**NOTICE:** The Ethernet Cable has a Receptacle on both ends. The Receptacle on the end of the Ethernet Cable with braided sleeving should be connected to the Advanced GPS Ethernet Connector, while the Receptacle on the bare end without sleeving should be connected to the fish finder.

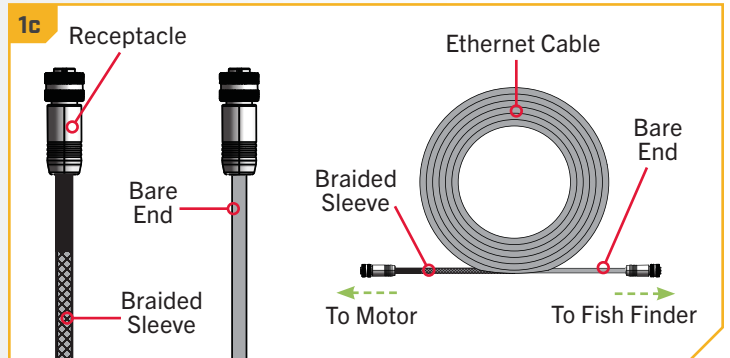
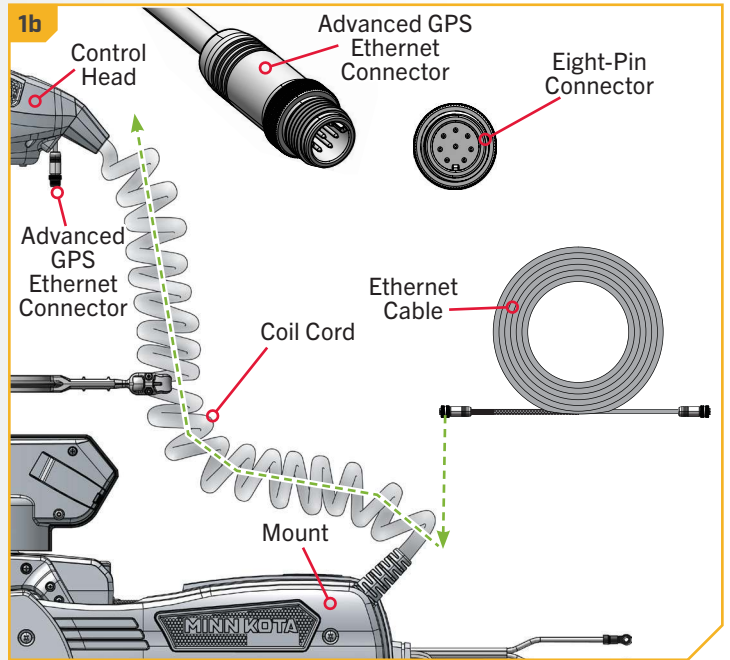

# ADVANCED GPS NAVIGATION

## 2

- d. Take the Receptacle on the end of the Ethernet Cable covered in a braided sleeve. The Receptacle with the braided sleeve will be inserted into the Coil Cord and connected to the Advanced GPS Ethernet Connector, while the Receptacle on the bare end of the Ethernet Cable will exit the Coil Cord and be connected to the Fish Finder.
- e. Run the Receptacle on the Ethernet Cable up through the bottom of the Coil Cord. The Ethernet Cable should float freely inside the Coil Cord. The Receptacle should exit from the top of the Coil Cord, with the other end exiting from the bottom of the Coil Cord near the Mount. Allow enough slack in the cable to attach the Receptacle to the Advanced GPS Ethernet Connector.

**NOTICE:** Ensure that the correct Receptacle on the Ethernet Cable is routed through the Coil Cord and connected to the Advanced GPS Ethernet Connector. The section of the Ethernet Cable covered in a braided sleeve must be routed through the Coil Cord and connected. Do not connect the Receptacle on the bare end to the motor. Failure to connect the correct Receptacle may result in damage to cables.

**NOTICE:** Once all accessory cables are connected, the final installation will require the Ethernet Cable to be secured. See the "Securing the Ethernet Cable" section of this document for details once all connections are complete.

## 3

- f. To install the Ethernet Cable, align the pins on the Advanced GPS Ethernet Connector with the Receptacle on the Ethernet Cable. Notice the keyed connectors. Tighten the Collar from the Ethernet Cable to secure the connection.
- g. The Ethernet Cable will plug directly into a Solix or Helix Fish Finder or directly into a Helix Adapter Cable.

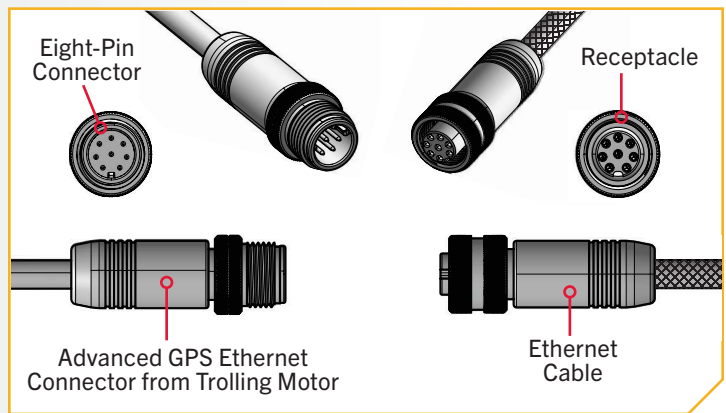
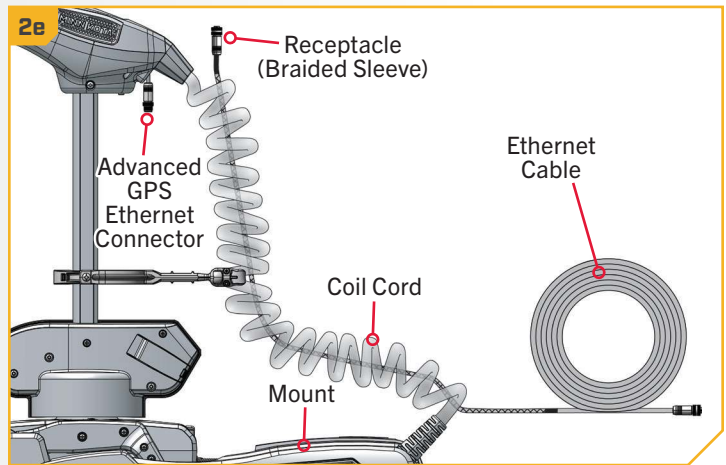
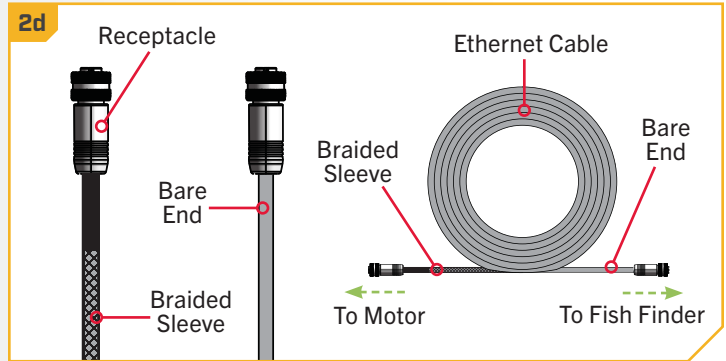

## 4

- h. If installing directly to a Solix or Apex, the connector will be flat on the back of the fish finder display.
- i. Align the Receptacle on the Ethernet Cable with the Eight-Pin Connector on the Apex or Solix fish finder. Notice the keyed connectors. Tighten the Collar from the Ethernet Cable to secure the connection. Once directly installed to the Solix or Apex, the connection is complete.

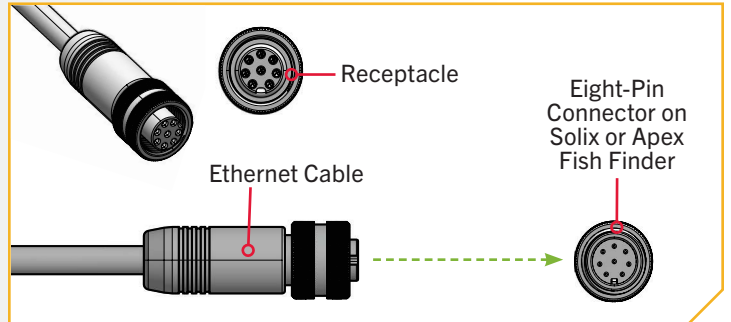

## 5

### ITEM(S) NEEDED



- j. If installing directly to a Helix Adapter Cable (Item #14), align the Receptacle on the Ethernet Cable with the Eight-Pin Connector on the Helix Adapter Cable provided. Notice the keyed connectors. Tighten the Collar from the Ethernet Cable to secure the connection.

**NOTICE:** Minn Kota provides one Helix Adapter Cable (AS EC QDE - Ethernet Adapter Cable - 720074-1) with every trolling motor equipped with Advanced GPS Navigation.

- k. The Helix Adapter Cable directly connects the Ethernet Cable to a Helix fish finder. Locate the Helix Adapter Cable Keyed Connector on the back of the fish finder. Plug the Helix Adapter Cable into the back of the Helix fish finder to complete the connection.

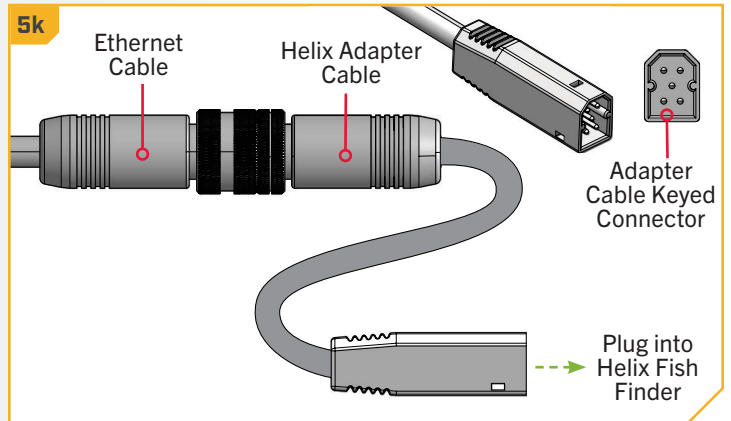
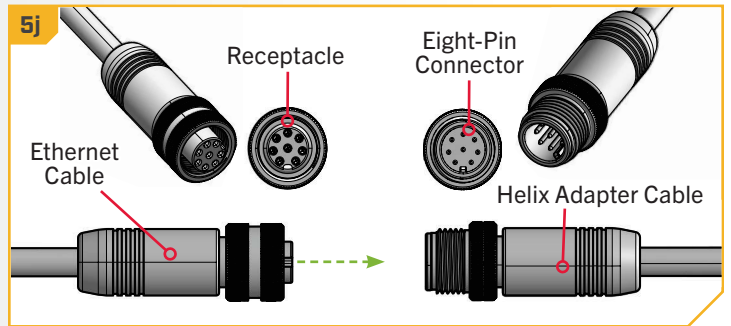

# SECURING THE ETHERNET CABLE

## › Securing the Ethernet Cable

The Ethernet Cable must be routed and all connections secured before completing the installation in this section. To review how the Ethernet Cable should be routed and connected, review the "Advanced GPS Navigation" section of this document.

### ⚠ CAUTION

Failure to follow the recommended wire routing for installed features, if equipped, may cause damage to the product and void your product warranty. Route cables away from pinch points or other areas that may cause them to bend in sharp angles. Routing the cables in any way other than directed may cause damage to the cables by being pinched or severed. Do not over-tighten the cable tie as it may damage the wire.

1

#### ITEM(S) NEEDED

 #15 x 1

- a. Place the motor in the stowed position.

**NOTICE:** For instructions on stowing the motor, see the "Stowing and Deploying the Riptide Instinct QUEST" section of this manual.

- b. Confirm that the Ethernet Cable is connected to an output device as desired. With the motor stowed, locate the Advanced GPS Ethernet Connector below the Control Head.
- c. Take a Cable Tie (Item #15) and secure the Ethernet Cable to the second coil of the Coil Cord. The Cable Tie should wrap around both the Ethernet Cable and Coil Cord. Secure the Cable Tie until it is fingertip tight. Do not over-tighten as it may damage the Ethernet Cable.

**NOTICE:** The Ethernet Cable should be secured to the second coil of the Coil Cord. Securing the Ethernet Cable to any other coil may damage the Cables.

### ⚠ CAUTION

Do not over-tighten the Cable Tie as it may damage the wires.

- d. Leave 6" of slack where the Ethernet Cable exits the Coil Cord. Bundle any excess cable in a loose loop no less than 4" in diameter.

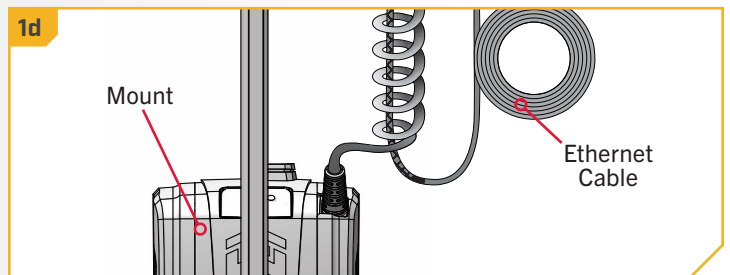
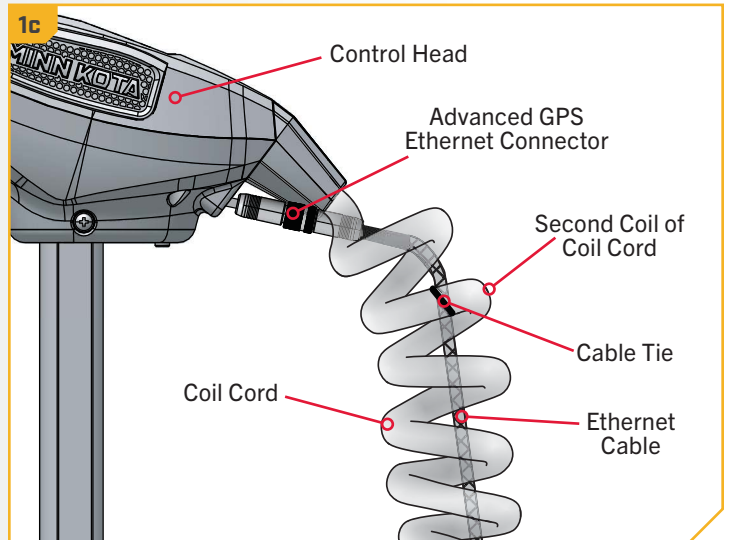

**NOTICE:** Minn Kota recommends routing the Ethernet Cable through the Coil Cord. Bypassing the Coil Cord when routing the Ethernet Cable is not recommended.

› Installing the Prop

1

ITEM(S) NEEDED

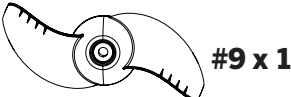

**CAUTION**

Disconnect the motor from the battery before beginning any prop work or maintenance.

- a. Take the Drive Pin (Item #12) and slide it through the Hole in the Armature Shaft. Position the Drive Pin horizontally by grasping the Armature Shaft and rotating it with the Drive Pin in place.
- b. Align the Prop (Item #9) so it is horizontal and parallel with the Drive Pin. Slide the Prop onto the Armature Shaft and Drive Pin until it is seated against the lower unit.
- c. Install the Prop Washer (Item #10) and the Prop Nut (Item #11) onto the end of the Armature Shaft.
- d. While holding the Prop horizontal, tighten the Prop Nut with a 9/16" Deep Well Socket. Tighten the Prop Nut to 25-35 in-lbs.

**CAUTION**

Do not over-tighten as this can damage the Prop.

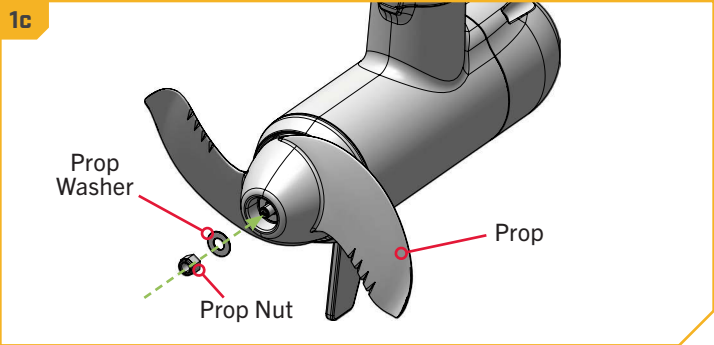
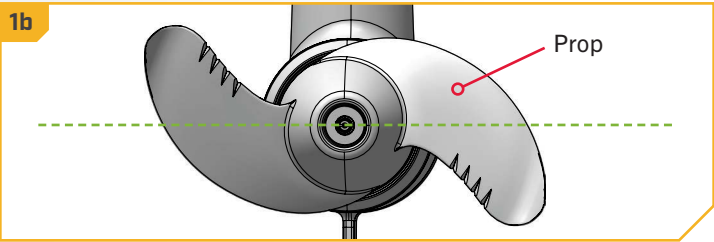
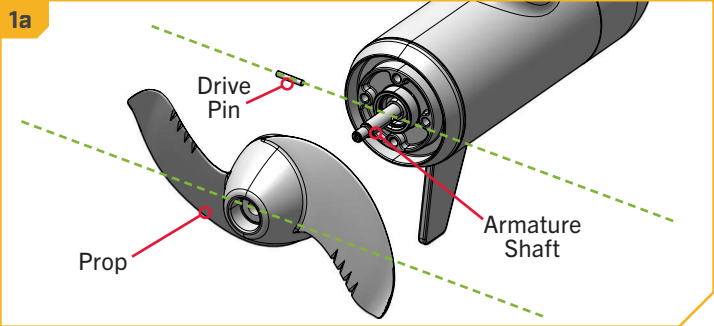

# ONE-BOAT NETWORK

## OPTIMIZING THE PERFORMANCE OF THE RIPTIDE INSTINCT QUEST WITH THE WIRELESS REMOTE OR ONE-BOAT NETWORK APP

Minn Kota® and Humminbird® have joined forces to bring you the One-Boat Network, including the latest Advanced GPS Navigation Wireless Remote and the One-Boat Network app. The Wireless Remote comes from the factory paired to the trolling motor. To learn more about Wireless Remote features, refer to the Wireless Remote Owner's Manual online at [minnkota.johnsonoutdoors.com](http://minnkota.johnsonoutdoors.com).

To get the most from your One-Boat Network, we encourage you to download the One-Boat Network app onto your smart device. The One-Boat Network® app is a free iOS and Android application that you can download to a mobile device, providing unparalleled control over all of your One-Boat Network connected products. Minn Kota recommends connecting the trolling motor to the OBN app to assist in these steps. For instructions on pairing the OBN app to the trolling motor, refer to the OBN Quick Start Guide included with the motor. For more information on the OBN app, refer to the One-Boat Network Owner's Manual online at [minnkota.johnsonoutdoors.com](http://minnkota.johnsonoutdoors.com).

Completing the installation of the Riptide Instinct QUEST through the Wireless Remote or OBN app should be done following the Prop installation. Ensure that the trolling motor is connected to a power source before adjusting One-Boat Network settings.

### **WARNING**

Take care that neither you nor other persons approach the turning propeller too closely, neither with body parts nor with objects. The motor is powerful and may endanger or injure you or others. Stay clear of the Prop and watch out for accidental engagement.

**NOTICE:** Ensure that the trolling motor is connected to a power source before adjusting One-Boat Network settings.

**NOTICE:** If the Wireless Remote is lost or becomes non-functioning during navigation, and the One-Boat Network app is unavailable, disconnect the motor from power to cancel all active navigation and turn off the Prop.

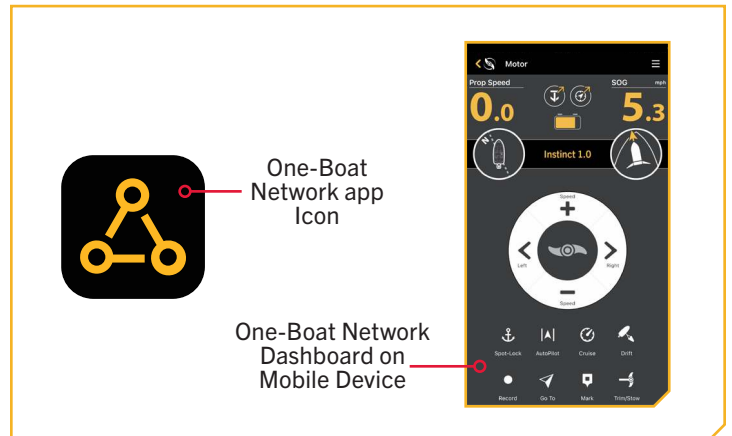

## ONE-BOAT NETWORK ADJUSTMENTS



### KEEL OFFSET

The Riptide Instinct QUEST comes from the factory with the Lower Unit parallel to the Mount. When the Lower Unit is parallel to the Mount, the Keel Offset is zero. In an ideal installation, the Lower Unit will be parallel to the Keel; however, the Mount is rarely installed to be perfectly inline with the Keel, therefore the Lower Unit will not be parallel with the Keel. Nearly all installations will have some variation in mounting position to either the Port or Starboard side of the boat. The Keel Offset feature records the position of the Lower Unit when it is parallel to the Keel based on the Mount being offset from the Keel. Before adjusting the Keel Offset, complete all installation steps. This includes mounting the trolling motor to the boat and installing power and accessory cables. The Keel Offset can be recorded through the Wireless Remote or One-Boat Network App.

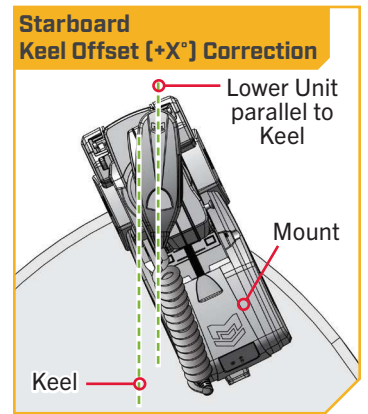
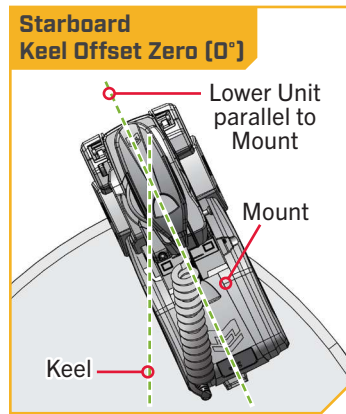
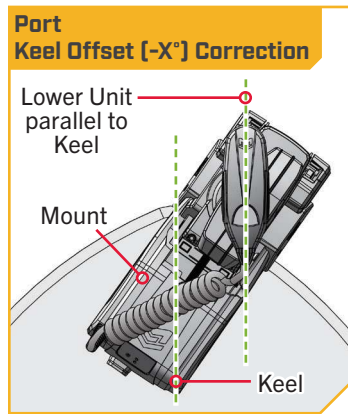
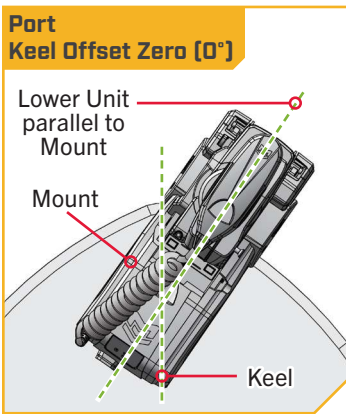
**NOTICE:** When the motor is installed from the factory, the Keel Offset is 0 degrees. When adjusting the Keel Offset, any position towards Port will create a Keel Offset of a negative angle. Any position towards Starboard will create a positive angle.







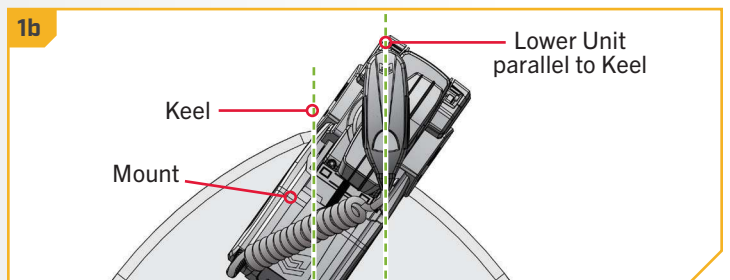
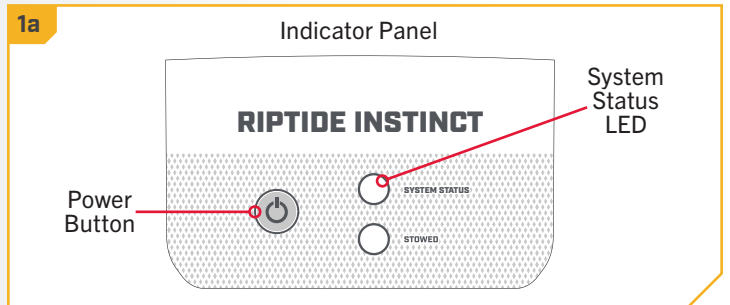



### Setting the Keel Offset with the Wireless Remote

- 1
  - a. Power on the trolling motor by pressing the Power  button on the Indicator Panel. When the trolling motor is on, the System Status  LED will be blue.
  - b. With either the Wireless Remote or One-Boat Network (OBN) app on a paired mobile device, steer the motor so that the control head and lower unit are parallel to the Keel.







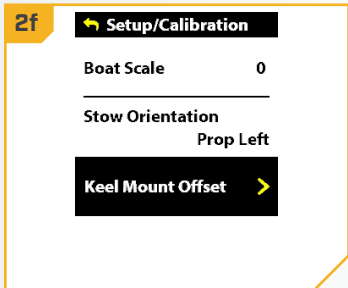
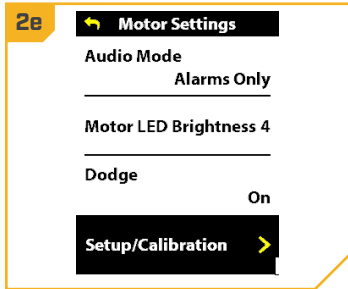
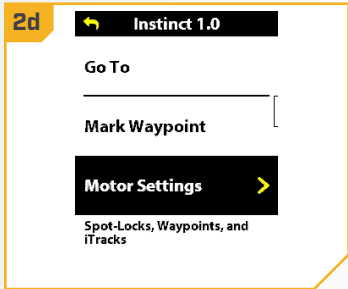

# KEEL OFFSET

## 2

- c. Press the Menu  button on the Wireless Remote.
- d. Use the Speed Up  or Speed Down  button to find the Motor Settings menu. Use the Steer Right  button to select Motor Settings.
- e. In the Motor Settings Menu, use the Speed Up  or Speed Down  button to find Setup/Calibration.
- f. In the Setup/Calibration menu, use the Speed Up  or Speed Down  button to find Keel Mount Offset. Use the Steer Right  button to select Keel Mount Offset.



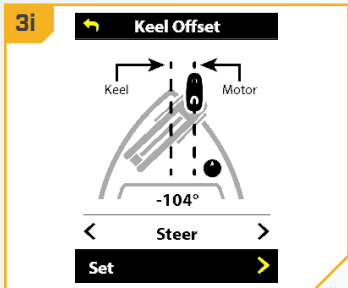
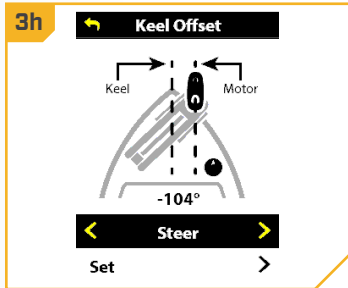
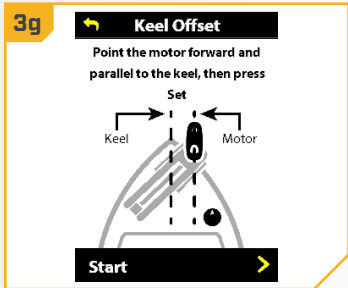

## 3

- g. Review all safety warnings. Use the Steer Right  button to select Start and begin the process.
- h. Use the Steer Left  or Steer Right  button to point the motor forward and parallel to the keel.
- i. When satisfied with the placement of the trolling motor, use the Speed Up  or Speed Down  button to scroll to Set. Use the Steer Right  button to select Set. The degree of offset is displayed at the bottom of the Dashboard.



## ▶ Setting the Keel Offset with the One-Boat Network App

### 1

- Power on the trolling motor by pressing the Power  button on the Indicator Panel. When the trolling motor is on, the System Status  LED will be blue.
- With either the Wireless Remote or One-Boat Network (OBN) app on a paired mobile device, steer the motor so that the control head and lower unit are parallel to the Keel.

### 1a

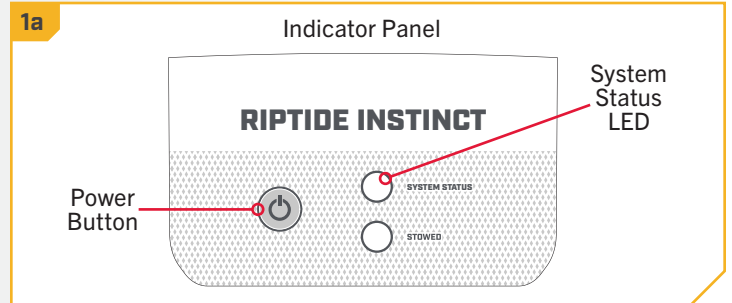

### 1b

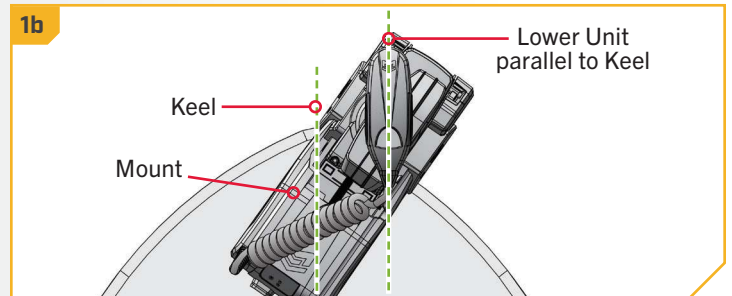

### 2

- Open the One-Boat Network (OBN) app on the mobile device. Make sure the mobile device is paired with the trolling motor.
- From the OBN home screen, tap the Motor menu. The Motor menu opens the Motor home screen.
- Before the Motor home screen will open, tap Agree on the on-screen prompt.

**NOTICE:** The on-screen prompt will only display once each time the app is launched. If the prompt has displayed, the Motor home screen appears.

- On the Motor home screen, locate the Motor Settings button in the upper-right corner and tap it.

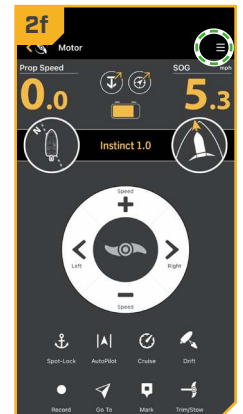
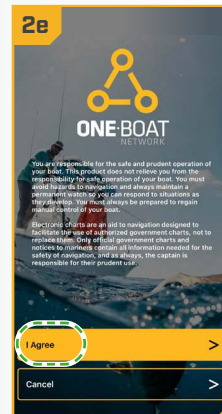
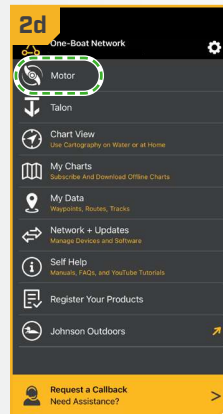

# KEEL OFFSET

3

- g. In the Motor Settings menu, find and tap Setup and Calibration.
- h. In Setup and Calibration, find and tap Keel Mount Offset.
- i. Review all safety warnings. Follow the prompts in the One-Boat Network app. If the placement of the trolling motor is pointing forward and parallel to the keel, tap Set. The degree of offset will show at the bottom of the app Display.

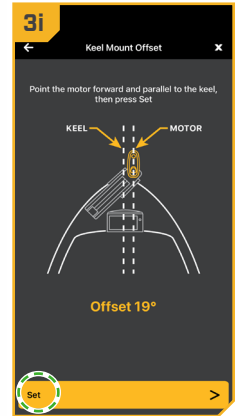
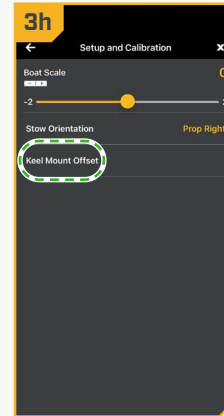
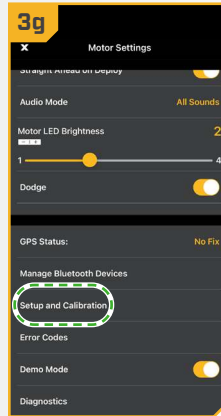

4

- j. If the trolling motor needs to be adjusted, locate the Return button on the upper-left corner of the app screen. Tap the Return button three times until the Motor home screen displays.
- k. Use the Steer Right > and Steer Left < buttons to point the motor forward and parallel to the keel.
- l. When satisfied with the placement of the trolling motor, locate the Motor Settings button in the upper-right corner and tap it.
- m. In the Motor Settings menu, find and tap Setup and Calibration.
- n. In Setup and Calibration, find and tap Keel Mount Offset. If the placement of the trolling motor is pointing forward and parallel to the keel, tap Set.
- o. The degree of offset shows at the bottom of the app Display. Tap Return to close the Keel Mount Offset and return to the home screen.

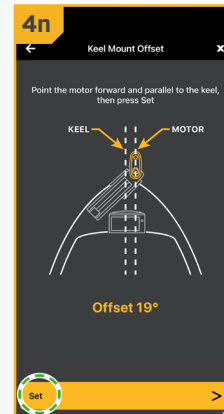
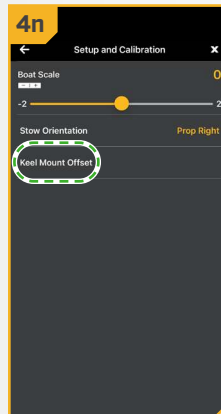
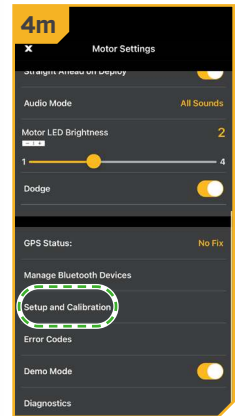
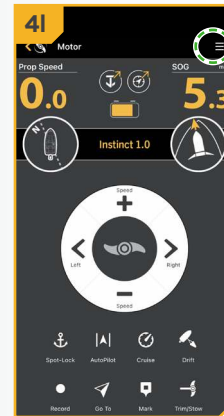
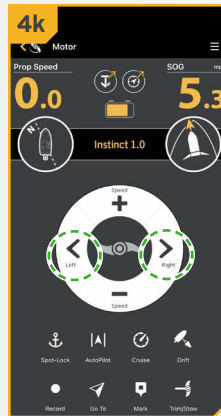

STRAIGHT ON DEPLOY

Minn Kota recommends setting the Keel Offset when the position of the Lower Unit is parallel with the Keel. Save the Keel Offset before exploring the Straight on Deploy feature. Straight on Deploy uses the position recorded in Keel Offset to know where to position the Lower Unit to be parallel with the Keel.

When Straight on Deploy is engaged, the lower unit will automatically rotate to the Keel Offset position when deployed. By default, the Lower Unit will be parallel to the Keel when the Mount is parallel to the Keel. If the Keel Offset was programmed to another angle, the Straight on Deploy feature will correct the position to match the Keel Offset angle when turned "on." If Straight on Deploy is turned "off," the trolling motor will not correct the position in any direction.

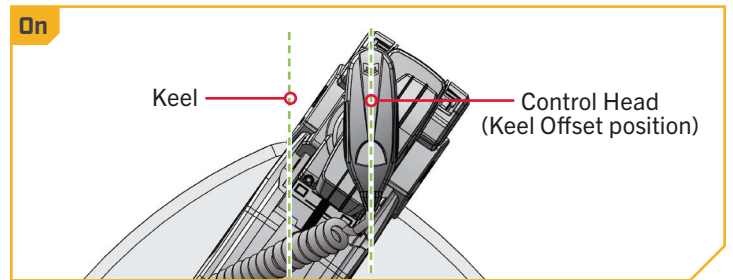
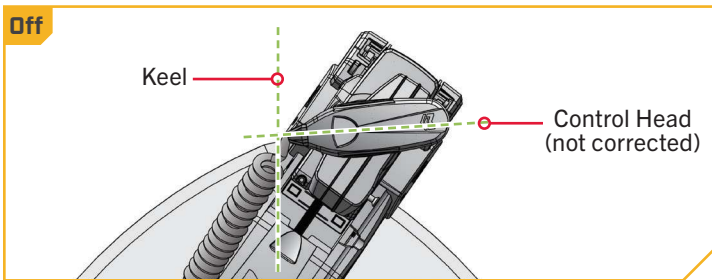

To Toggle Straight on Deploy with the Wireless Remote

- 1
  - a. With the motor on, press the Menu button on the Wireless Remote.
  - b. Use the Speed Up or Speed Down button to find the Motor Settings menu. Use the Steer Right button to select Motor Settings.
  - c. In the Motor Settings Menu, use the Speed Up or Speed Down button to find Straight on Deploy.
  - d. By default, the Straight on Deploy is toggled "off."
  - e. Use the Steer Right button to toggle between "on" and "off."

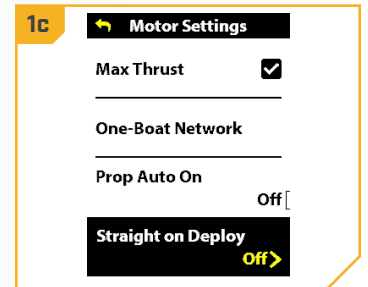
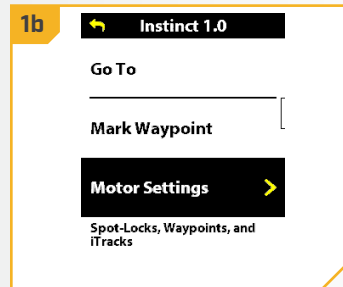

# STRAIGHT ON DEPLOY

## ▶ To Toggle Straight on Deploy with the One-Boat Network App

1

- a. Open the One-Boat Network (OBN) app on a mobile device. Make sure the mobile device is paired with the trolling motor and that the motor is powered "on."
- b. From the OBN home screen, tap the Motor menu. The Motor menu opens the Motor home screen.
- c. Before the Motor home screen will open, tap Agree on the on-screen prompt.

**NOTICE:** The on-screen prompt will only display once each time the app is launched. If the prompt has displayed, the Motor home screen appears.

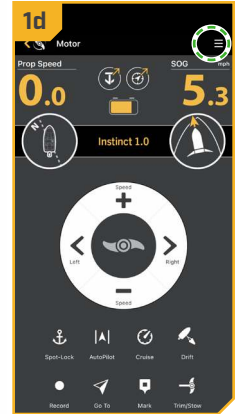
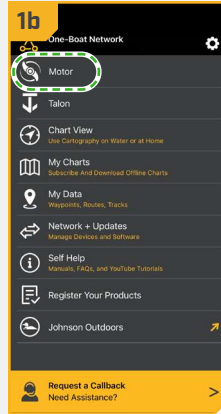

- d. On the Motor home screen, locate the Motor Settings button in the upper-right corner and tap it.

2

- e. In the Motor Settings menu, find the Straight Ahead on Deploy toggle. Tap to turn the toggle "on" and "off." When highlighted yellow the toggle is "on."

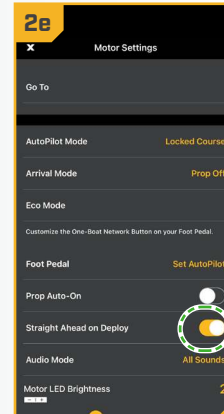
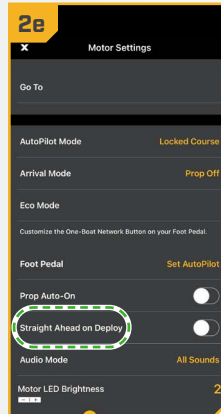

## STOW ORIENTATION

The Stow Orientation is a term used to describe the lower unit and Prop position when the motor is stowed. The lower unit will automatically rotate into the Stow Orientation when stowing the motor. The Stow Orientation can be set to Prop Left or Prop Right through the Wireless Remote or One-Boat Network app. The factory default setting for the lower unit is Prop Left. Adjusting the Stow Orientation allows the installation to be customized to fit boat positioning for either a Port or Starboard installation and to accommodate fishing or trailering applications.

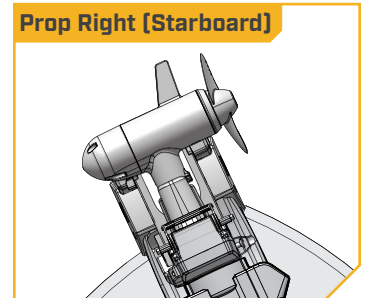
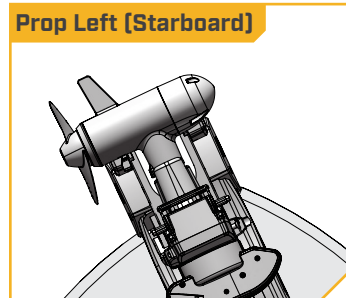
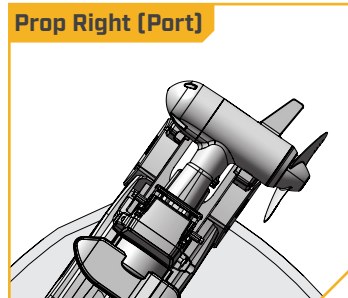
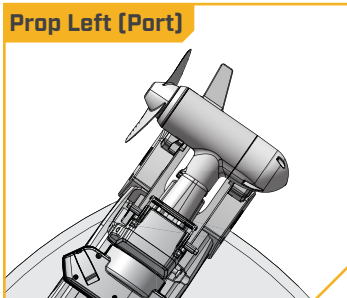

### Setting the Stow Orientation with the Wireless Remote

- 1**
  - a. With the trolling motor powered on, press the Menu button on the Wireless Remote.
  - b. Use the Speed Up or Speed Down button to find the Motor Settings menu. Use the Steer Right button to select Motor Settings.
  - c. In the Motor Settings Menu, use the Speed Up or Speed Down button to find Setup/Calibration. Use Steer Right to open the Setup/Calibration menu.

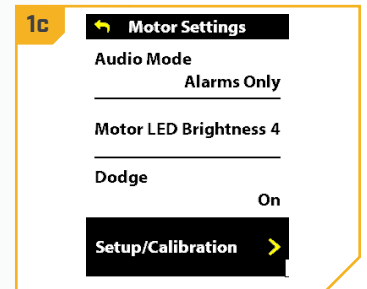
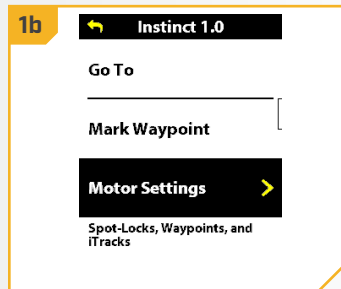

- 2**
  - d. Once in the Setup/Calibration menu, use the Speed Up or Speed Down button to find Stow Orientation. Use Steer Right to open the Stow Orientation menu.
  - e. In the Stow Orientation menu, use the Speed Down or Speed Up button to scroll between Prop Left and Prop Right. Use the Steer Right button to select the desired stow orientation.

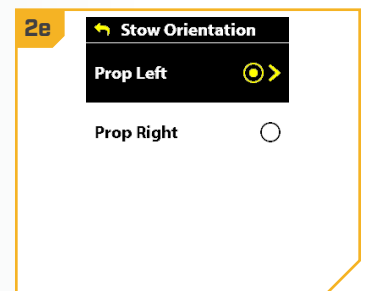
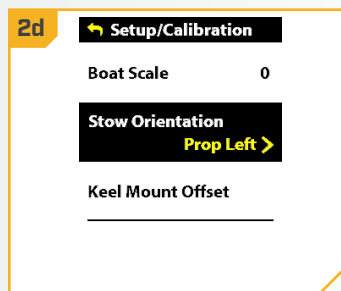

# STOW ORIENTATION

## ▶ Setting the Stow Orientation with the One-Boat Network App

1

- a. Open the One-Boat Network (OBN) app on a mobile device. Make sure the mobile device is paired with the trolling motor and that the motor is powered "on."
- b. From the OBN home screen, tap the Motor menu. The Motor menu opens the Motor home screen.
- c. Before the Motor home screen will open, tap Agree on the on-screen prompt.

**NOTICE:** The on-screen prompt will only display once each time the app is launched. If the prompt has displayed, the Motor home screen appears.

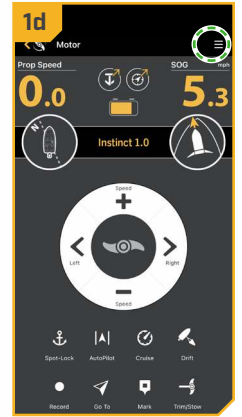
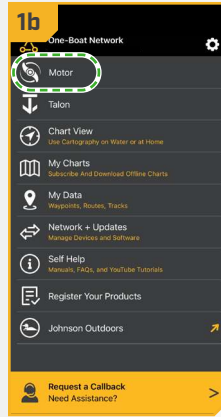

- d. On the Motor home screen, locate the Motor Settings button in the upper-right corner and tap it.

2

- e. In the Motor Settings menu, find and tap Setup and Calibration.
- f. In Setup and Calibration, find and tap Stow Orientation.
- g. Set the feature to Prop Right or Prop Left.

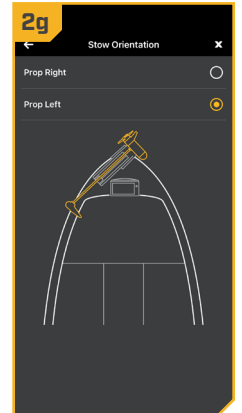
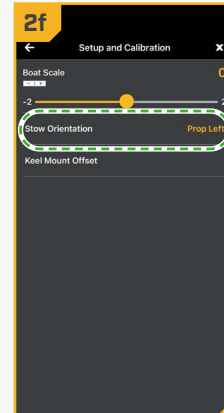
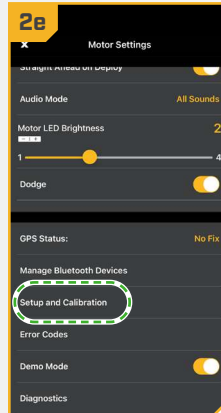







BOAT SCALE





Trolling motor performance can be impacted by factors including, but not limited to, wind, water conditions, boat specifications, battery health, wiring, etc. Boat Scale provides a method of adjusting how the trolling motor will perform to account for these and other variables. The Riptide Instinct QUEST comes from the factory with Boat Scale set to zero. Boat Scale can be adjusted up (+2) or down (-2) to increase or decrease how the motor control software applies power while using a navigation mode like Spot-Lock.

An example showing the need to reduce Boat Scale would be while using Spot-Lock and the motor is over-correcting or making frequent adjustments. In this case, try reducing Boat Scale -1 to reduce this behavior. If the behavior continues, reduce Boat Scale to -2. An example showing the need to increase Boat Scale while using Spot-Lock would be the motor is drifting away from its target location frequently or needs help to make corrections. Try increasing Boat Scale to +1 to help improve the trolling motor accuracy in this case. If the behavior continues, increase Boat Scale to +2.

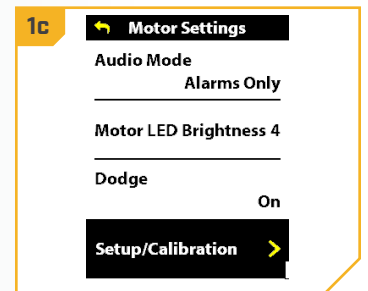
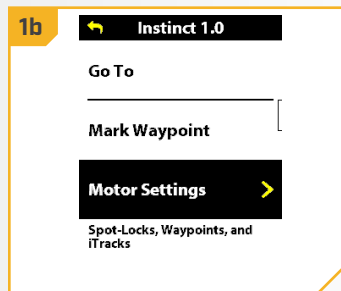
Adjusting Boat Scale with the Wireless Remote

- 1
  - a. With the motor on, press the Menu  button on the Wireless Remote.
  - b. Use the Speed Up  or Speed Down  button to find the Motor Settings menu. Use the Steer Right  button to select Motor Settings.
  - c. In the Motor Settings Menu, use the Speed Up  or Speed Down  button to find Setup/Calibration.



- 2
  - d. Once in the Setup/Calibration menu, use the Speed Up  or Speed Down  button to find Boat Scale.
  - e. Use the Steer Left  or Steer Right  button to adjust the Boat Scale to one of the five settings: -2, -1, 0, 1 or 2.

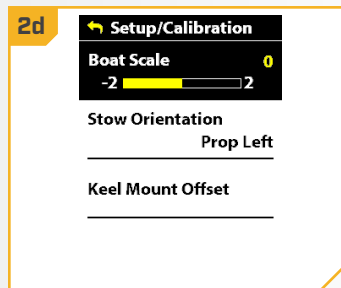

# BOAT SCALE

## ▶ Adjusting Boat Scale with the One-Boat Network App

1

- Open the One-Boat Network (OBN) app on a mobile device. Make sure the mobile device is paired with the trolling motor and that the motor is powered "on."
- From the OBN home screen, tap the Motor menu. The Motor menu opens the Motor home screen.
- Before the Motor home screen will open, tap Agree on the on-screen prompt.

**NOTICE:** The on-screen prompt will only display once each time the app is launched. If the prompt has displayed, the Motor home screen appears.

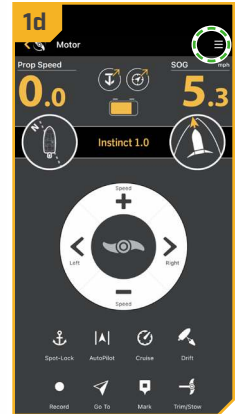
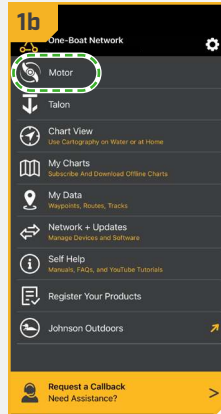

- On the Motor home screen, locate the Motor Settings button in the upper-right corner and tap it.

2

- In the Motor Settings menu, find and tap Setup and Calibration.
- In Setup and Calibration, find and tap Boat Scale.
- Set the feature to increase or decrease Boat Scale.

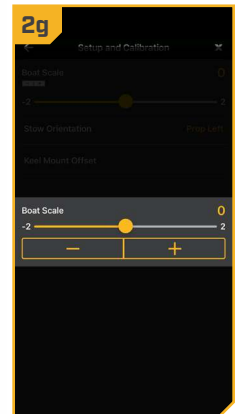
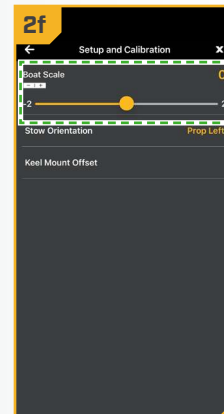
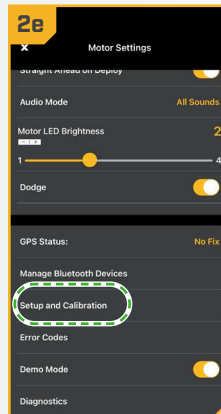





# ONE-BOAT NETWORK BUTTONS

## ONE-BOAT NETWORK BUTTONS

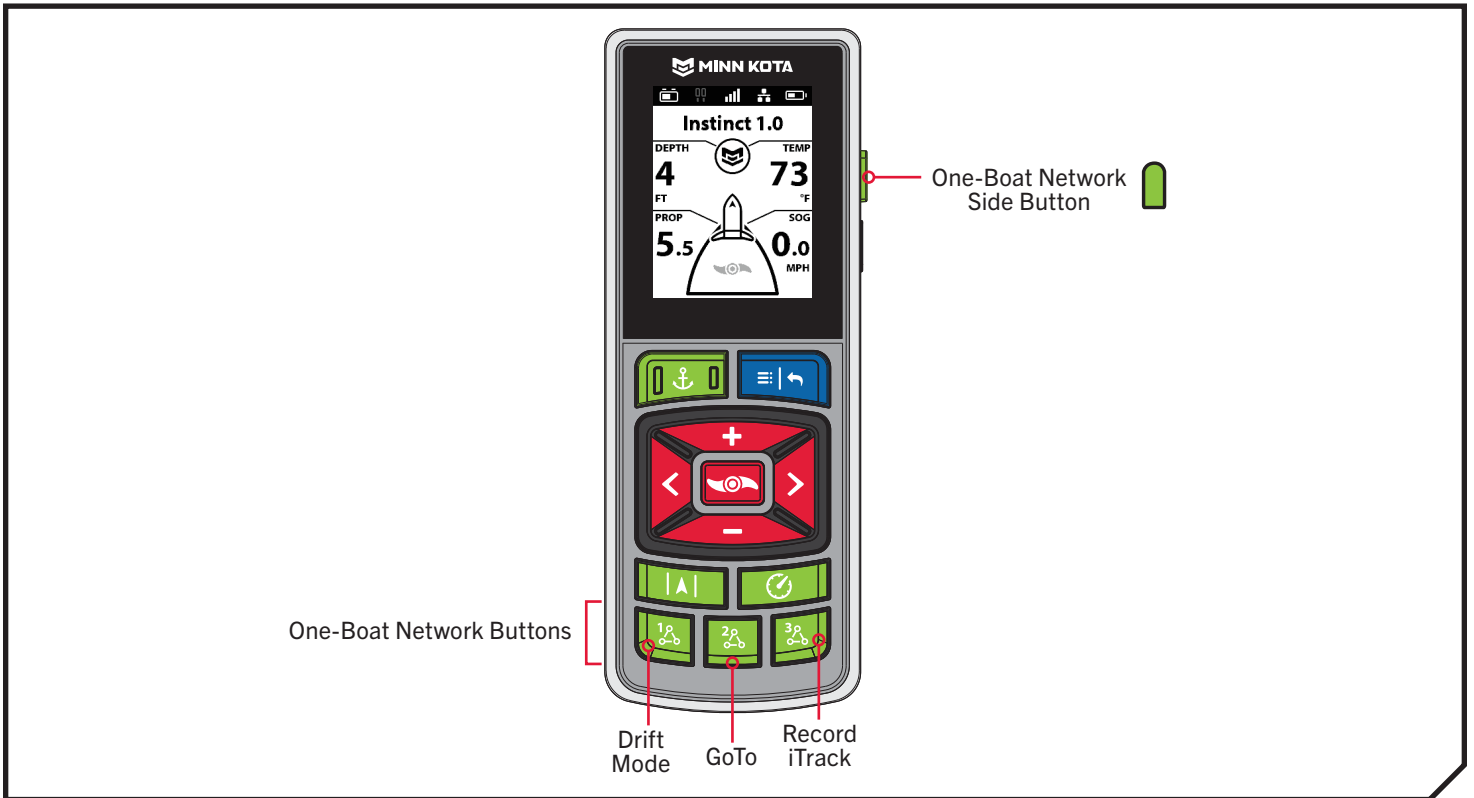
Minn Kota trolling motors equipped with Advanced GPS Navigation are compatible with devices enabled with the One-Boat Network (OBN), such as the Wireless Remote. OBN functions can be enabled and disabled through four customizable OBN buttons on the Wireless Remote. The function of the OBN buttons can be customized based on user preference to enhance operation of the OBN product.

## CUSTOMIZING THE ONE-BOAT NETWORK BUTTONS ON THE WIRELESS REMOTE









One-Boat Network Default Buttons			
	Drift Mode		Record iTrack
	GoTo		Deployment Mode

# CUSTOMIZING THE ONE-BOAT NETWORK BUTTONS ON THE WIRELESS REMOTE













One-Boat Network functions can be enabled and disabled through four One-Boat Network buttons on the Wireless Remote. The One-Boat Network buttons can be customized to control the following functions, depending on your setup:

Function	Icon	Description
Drift Mode		Drift mode is the default function for OBN Button 1. Press once to engage Drift Mode. Press a second time to Adjust Course.
Go To		Go To is the default for the OBN Button 2. Press once to open the Go To Menu. The Go To options are Spot-Locks, Waypoints, iTracks and Drift.
Record iTrack		Record iTrack is the default function for OBN Button 3. Press once to start recording an iTrack. Press a second time to save the iTrack.
Waypoint		Mark Waypoint must first be customized to one of the OBN buttons. Press once to save a Waypoint.
Max Speed		Max Speed must first be customized to one of the OBN buttons. Double press to engage Max Speed. Single press to return to the previous speed.
Talon/Raptor		The shallow water anchor function must first be customized to one of the OBN buttons. The shallow water anchor function will display as Talon or Raptor depending on your configuration. Double press to deploy the anchor. Press once to pause or stow the anchor.
Deployment Mode		Deployment Mode is the default function for the OBN Side Button on trolling motors with a stow/deploy and trim function. The Deployment Mode function will display as Instinct. Press the OBN Side Button once to bring up the Instinct menu.

# CUSTOMIZING THE ONE-BOAT NETWORK BUTTONS ON THE WIRELESS REMOTE





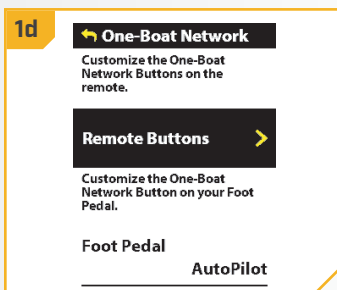
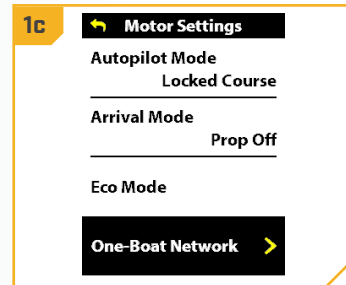
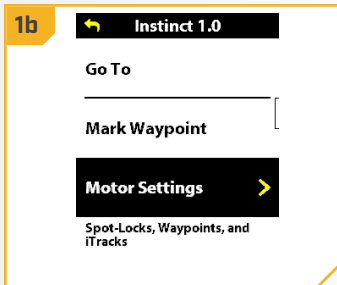

## › Customize the One-Boat Network Buttons on the Wireless Remote

1

- On the Wireless Remote, press the Menu  button to open the Motor Menu.
- In the Motor Menu, use the Speed Down  or Speed Up  button to find the Motor Settings menu. Use the Steer Right  button to select Motor Settings.
- In the Motor Settings menu, use the Speed Down  or Speed Up  button to find One-Boat Network. Use the Steer Right  button to select One-Boat Network.
- In the One-Boat Network Menu, use the Speed Down  or Speed Up  button to find Remote Buttons. Use the Steer Right  button to select Remote Buttons.



2

- Use the Speed Down  or Speed Up  button to highlight the OBN button to customize. There are four options: Button 1, Button 2, Button 3 or Side Button. Press the Steer Right  button to make the selection.
- Use the Speed Down  or Speed Up  button to scroll through the options. Use the Steer Right  button to select the function.

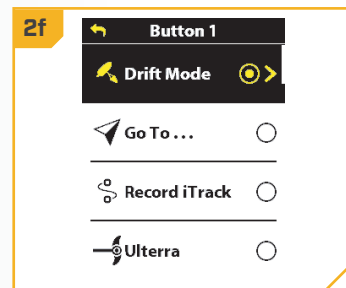
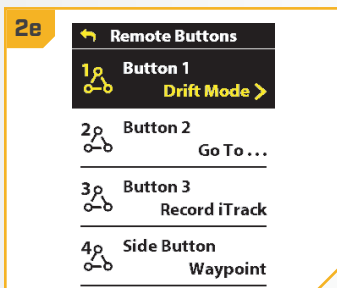

**NOTICE:** The radio button next to the desired function will be selected when the Steer Right  button is used to customize the function. The function options listed are based on the trolling motor and other devices in the Advanced GPS Navigation network.

**NOTICE:** For quick customization, press and hold the OBN button you want to customize to quickly bring up the customization screen.

- Press and hold the Menu  button to close and return to the Home Screen.



# USING & ADJUSTING THE MOTOR

## MOUNT FEATURES

Become familiar with the features of the motor to maximize the capabilities this product offers.

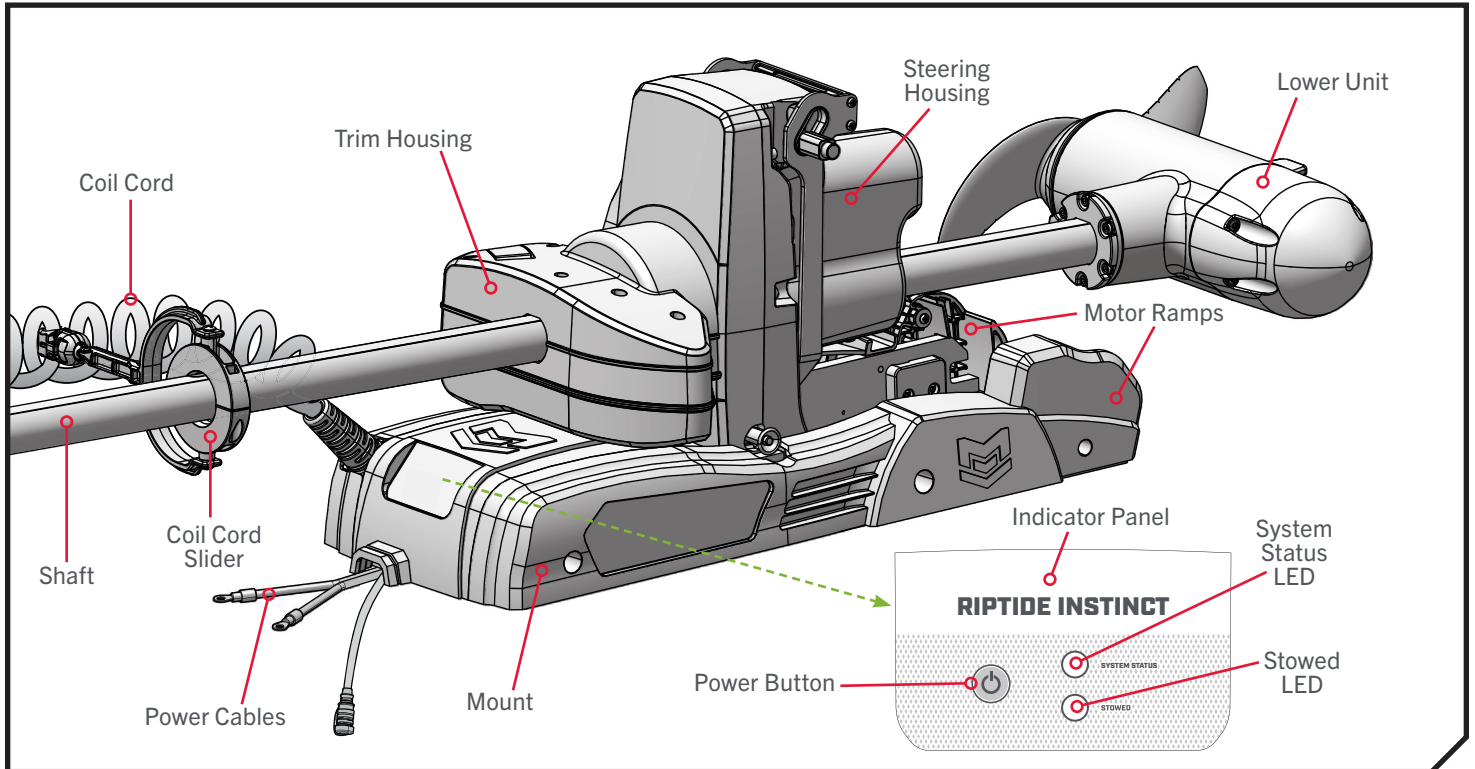

### › Mount

The Mount holds the motor on the deck of the boat. The Mount positions the motor when deployed and secures the motor flat on the deck when stowed. The Indicator Panel is located on the end of the Mount, near the Power Cables.

### › Motor Ramps

The Motor Ramps hold and support the Lower Unit when the motor is stowed. When the Lower Unit rests securely on the Motor Ramps, the **STOWED** LED on the Indicator Panel will illuminate orange. The Motor Ramps also hold the motor in the deployed position.

**⚠ WARNING**

When stowing or deploying the motor, keep fingers clear of all hinges, pivot points, pinch points and all moving parts.

### › Coil Cord Slider

Motors with a shaft length of 72", 87", or 100" have a Coil Cord Slider. The Coil Cord Slider functions to support the Coil Cord and prevent it from becoming tangled or hitting obstructions. The Coil Cord Slider sits on the Shaft between the Control Head and Trim Housing. The arm of the Coil Cord Slider connects to the Coil Cord. The Coil Cord Slider floats freely on the shaft and moves with the Coil Cord while stowing and deploying. The Coil Cord Slider is not present on motors with a shaft length of 60".

# INDICATOR PANEL

## **WARNING**

When transporting the motor, it is important to always stow the motor and ensure the Lower Unit is securely placed on the Motor Ramps. The STOWED  LED on the Indicator Panel must illuminate orange to indicate a secure stow. A secure stow holds the motor in place during transportation when it is subject to high levels of shock and vibration. Failure to securely stow the motor may result in injury or damage to the unit.





## **CAUTION**

Ensure that the Power  button is turned off when the motor is not in use. For safety reasons, disconnect the motor from the batteries when the motor is not in use or while the batteries are charging. If the motor control is left on and the Prop rotation is blocked, severe motor damage can result.

## INDICATOR PANEL

The Indicator Panel is located on the end of the Mount, by the Power Cables. Power to the motor is turned "on" and "off" through the Power  button on the Indicator Panel. The LEDs on the Indicator Panel communicate the status of the motor.

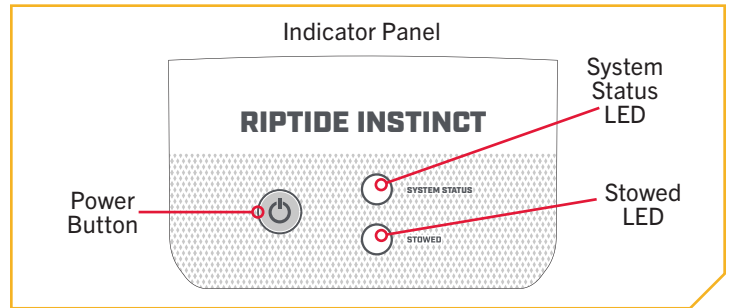

### › Power Button

On the Indicator Panel, press the Power  button once to turn the motor "on." When the motor is powered on, the System Status  LED will illuminate blue. To turn the motor "off," press and release the Power  button. When the motor is powered off, the System Status  LED will not be illuminated. The Riptide Instinct QUEST has an auto-shutoff and will automatically power off after 90 minutes of inactivity in the stowed position.







### › LED Patterns

#### STOWED

- **Orange solid**  - Indicates that the trolling motor is stowed and the Lower Unit is resting securely on the Motor Ramps. When the Lower Unit is off of the Motor Ramps, the STOWED  LED will not be illuminated.

#### SYSTEM STATUS

- **Blue solid**  - Normal operation. The trolling motor is powered on. When the Motor is powered off, the System Status  LED will not be illuminated.
- **Red flashing**  - Critical error. The Prop will lock and cannot be engaged. A critical error must be manually cleared by correcting the source of the error. Once fixed, cycle power to the trolling motor by pressing the Power  button "off" and then back "on" to clear the error and resume normal operation.

## **WARNING**

The trolling motor is not safely stowed for transport until the orange STOWED  LED is illuminated.

**NOTICE:** When encountering a critical error, the Wireless Remote will provide an error code in the Diagnostics menu. Refer to the Wireless Remote Owner's Manual to learn more about error codes.

# STOWING AND DEPLOYING THE RIPTIDE INSTINCT QUEST

## STOWING AND DEPLOYING THE RIPTIDE INSTINCT QUEST





The Riptide Instinct™ QUEST™ gives you push-button command from anywhere on the boat. Stow, deploy or trim the motor up and down by using the buttons on your Advanced GPS Navigation Wireless Remote, Foot Pedal, One-Boat Network app, or a connected Humminbird® fish finder. It's instant. Effortless. And it makes Riptide Instinct QUEST the easiest-to-use motor on the water.



Use the following procedures to stow and deploy the motor. If the motor stalls when attempting to stow, the motor may be encountering an error. Check for obstructions or low motor batteries. If the batteries are too low to fully stow the motor, re-engage power, deploy the motor, trim the lower unit to its highest setting, and turn power off until batteries can be recharged. Once batteries are charged, attempt to stow the motor again.

### STOW & DEPLOY >

## STOWING AND DEPLOYING WITH THE WIRELESS REMOTE

### > Deploying with the Wireless Remote

- 1 a. Press the Power  button on the Wireless Remote.
- b. Use the Speed Up  or Speed Down  button to find Instinct.
- c. Press the Steer Right  button to select Instinct and open Deployment Mode.

**NOTICE:** Alternatively, press the One-Boat Network  side button to quickly access Deployment Mode. The function of the OBN  side button is set by default to open the Instinct Deployment Mode menu.

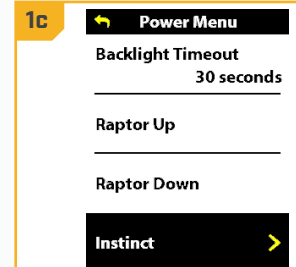
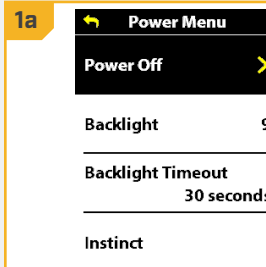

**NOTICE:** The Wireless Remote comes from the factory paired to the Riptide Instinct QUEST.



# STOWING WITH THE WIRELESS REMOTE

2

- d. Press the Steer Right  button to select Deploy. The motor will automatically deploy.

 **WARNING**

As soon as Deploy is selected, the motor will automatically deploy. Be sure that the motor is clear from obstructions and has a clear path of travel. The Prop is disabled while the motor is stowing or deploying to prevent accidental contact with the rotating Prop.



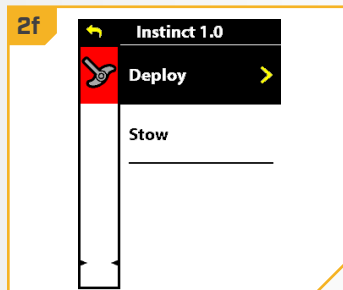
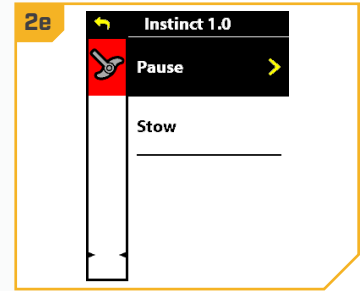
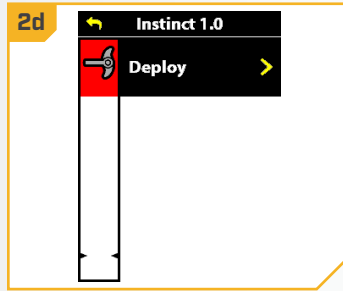

- e. While the Motor is deploying, it is possible to pause the action. To pause the action, press the Steer Right  button to select Pause.
- f. To resume the Deploy action, press the Steer Right  button to select Deploy.
- g. If the Motor continues, it will complete the deploy process and normal motor operation will follow.





**NOTICE:** To avoid churning or agitation of surface water, ensure that the top of the motor is submerged at least 12" below the surface of the water.

## Stowing with the Wireless Remote

1

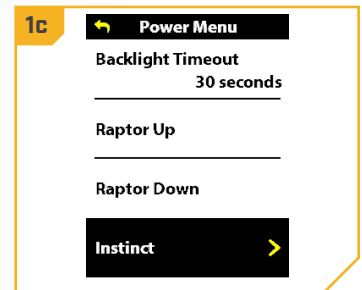
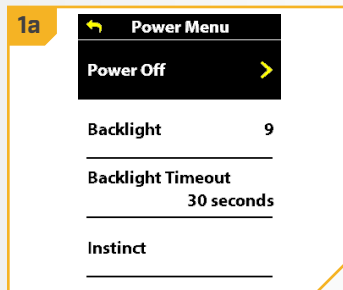

- a. Press the Power  button on the Wireless Remote.
- b. Use the Speed Up  or Speed Down  button to find Instinct.
- c. Press the Steer Right  button to select Instinct and open Deployment Mode.

**NOTICE:** Alternatively, press the One-Boat Network  side button to quickly access Deployment Mode. The function of the OBN  side button is set by default to open the Instinct Deployment Mode menu.





# STOWING WITH THE WIRELESS REMOTE

2

- d. Use the Speed Up  or Speed Down  button to find Stow. Use the Steer Right  button to select it. Once selected, the motor will automatically stow, and the Prop will be disabled.

## WARNING

As soon as Stow is selected, the motor will automatically stow. Be sure the motor is clear from obstructions and has a clear path of travel. The Prop is disabled while the motor is stowing or deploying to prevent accidental contact with the rotating Prop.

- e. While the Motor is stowing, it is possible to pause the action. To pause the action, press the Speed Down  button to find Pause and press the Steer Right  button to select it.
- f. To resume the Stow action, press the Steer Right  button to select Stow.
- g. If the Motor continues, it will complete the Stow process and normal motor operation will follow.

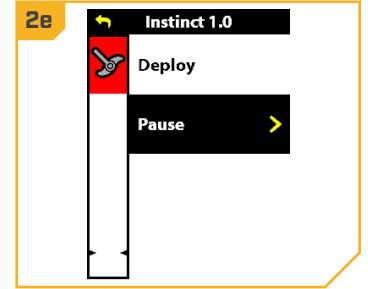
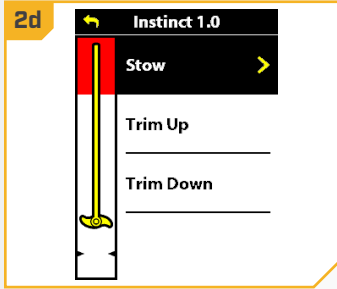

**NOTICE:** The Stow option is only displayed when the motor is deployed.

## WARNING

The motor is not safely stowed for transport until the orange STOWED  LED on the Indicator Panel is illuminated.

# DEPLOYING WITH THE OBN APP

## STOWING AND DEPLOYING WITH THE ONE-BOAT NETWORK (OBN) APP

### Deploying with the OBN App

- 1 a. Open the One-Boat Network (OBN) app on the mobile device. Make sure the mobile device is paired with the trolling motor.
- b. From the OBN home screen, tap the Motor menu. The Motor menu opens the Motor home screen.
- c. Before the Motor home screen will open, tap Agree on the on-screen prompt.

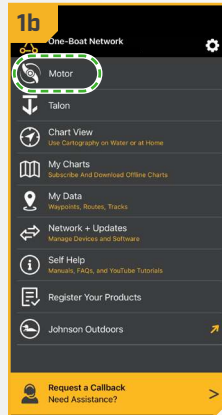

**NOTICE:** The on-screen prompt will only display once each time the app is launched. If the prompt is displayed, the Motor home screen appears after.

- 2 d. Tap Trim/Stow on the bottom of the screen to open the Trim/Stow/Deploy menu.
- e. Tap Deploy to automatically deploy the motor. Normal motor operation will follow.

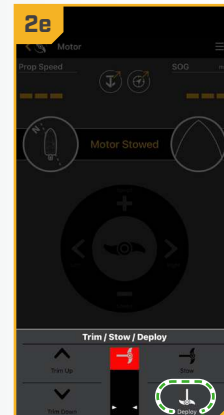
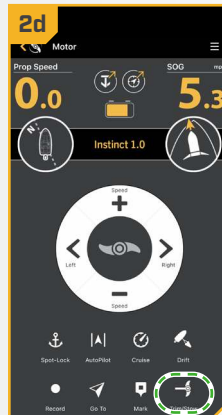

### WARNING

As soon as Deploy is tapped, the motor will automatically deploy. Be sure that the motor is clear from obstructions and has a clear path of travel. The Prop is disabled while the motor is stowing or deploying to prevent accidental contact with the rotating Prop.

**NOTICE:** While the motor is deploying, it is possible to stop the action by tapping Pause. To resume, tap the desired action.

**NOTICE:** To avoid churning or agitation of surface water, ensure that the top of the motor is submerged at least 12" below the surface of the water.

## › Stowing with the OBN App

1

- a. Open the One-Boat Network (OBN) app on the mobile device. Make sure the mobile device is paired with the trolling motor.
- b. From the OBN home screen, tap the Motor menu. The Motor menu opens the Motor home screen.
- c. Before the Motor home screen will open, tap Agree on the on-screen prompt.

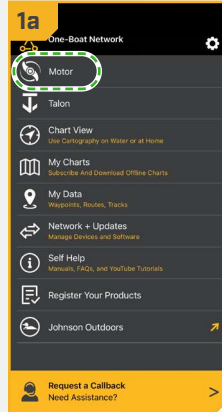

**NOTICE:** The on-screen prompt will only display once each time the app is launched. If the prompt has displayed, the Motor home screen appears after.

2

- d. Tap Trim/Stow on the bottom of the screen to open the Trim/Stow/Deploy menu.
- e. Tap Stow to automatically stow the motor. The Prop will be disabled and "Motor Stowed" will display on the screen.

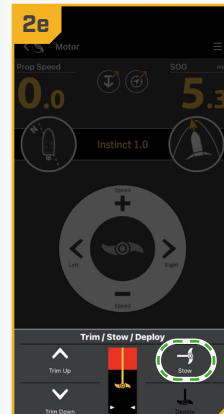

### WARNING

As soon as Stow is tapped, the motor will automatically stow. Be sure the motor is clear from obstructions and has a clear path of travel. The Prop is disabled while the motor is stowing or deploying to prevent accidental contact with the rotating Prop.

**NOTICE:** While the motor is stowing, it is possible to stop the action by tapping Pause. To resume, tap the desired action.

### WARNING

The motor is not safely stowed for transport until the orange STOWED LED on the Indicator Panel is illuminated.

# ADJUSTING THE DEPTH (TRIM) OF THE RIPTIDE INSTINCT QUEST

## ADJUSTING THE DEPTH (TRIM) OF THE RIPTIDE INSTINCT QUEST

Once the boat is on the water, it may be necessary to adjust the trim of the Lower Unit up or down to achieve an optimum depth for motor performance. When setting the depth of the motor, be sure the top of the Lower Unit is submerged at least 12" below the surface of the water to avoid churning or agitation of surface water. It may be necessary to trim the motor up or down, depending on how the boat is responding. Trim up to avoid hitting underwater objects and trim down if the Prop is coming out of the water.

The Prop will temporarily stop while trimming the motor and resume once trimming is stopped. The motor is programmed to operate safely and limit Prop rotation when the Lower Unit is trimmed within certain limits. Trim limits are in place to avoid damage to the unit. A Lower Trim Limit is set approximately 3" from the bottom of the Control Head to the top of the Trim Housing. An Upper Trim Limit is set 13 1/2" from the bottom of the Mount to the center of the Lower Unit. A Prop Lockout Region, defined as 16" from the bottom of the Mount to the center of the Lower Unit, is used to eliminate the possibility of the motor contacting the boat hull. All functions, except for manual steering and recording an iTrack, are canceled upon trimming into this region.

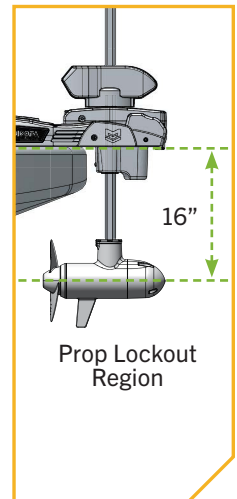
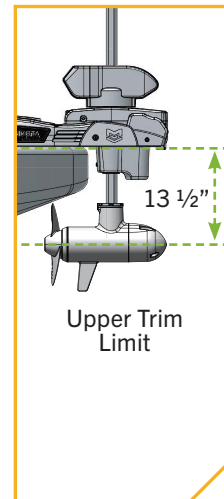
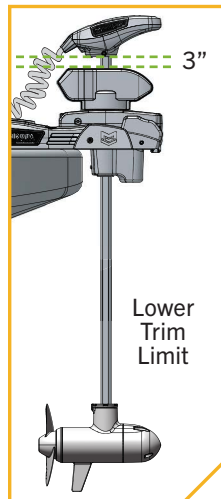
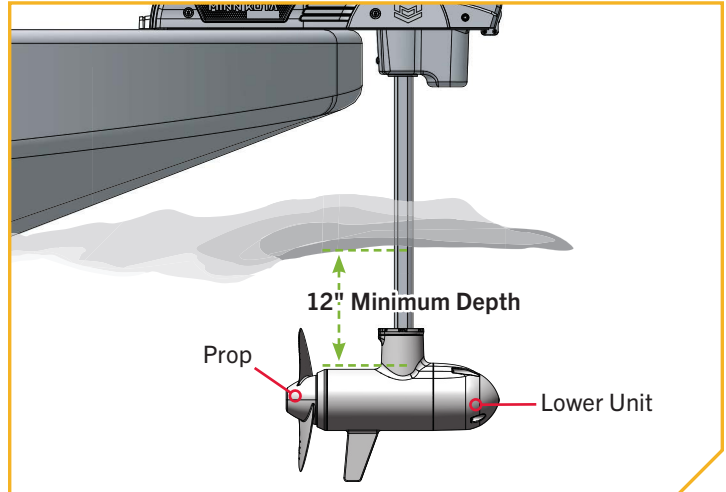

## ▶ Trimming with the Wireless Remote

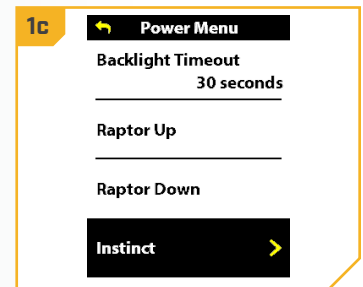
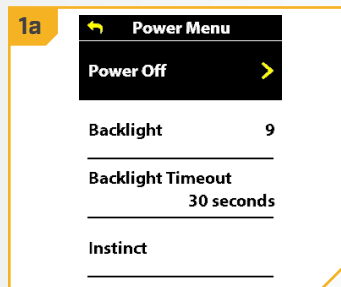

- 1 a. Press the Power button on the Wireless Remote.
- b. Use the Speed Up or Speed Down button to find Instinct.
- c. Press the Steer Right button to select Instinct and open Deployment Mode.

**NOTICE:** Alternatively, press the One-Boat Network side button to quickly access Deployment Mode. The function of the OBN side button is set by default to open the Instinct Deployment Mode menu.



## TRIMMING WITH THE WIRELESS REMOTE

2

- d. Once in Instinct Menu, use the Speed Up  or Speed Down  button to select Trim Up or Trim Down. Trimming up will raise the motor and trimming down will lower the motor.
- e. Press and hold the Steer Right  button to select it.
- f. When the motor has reached its highest trim limit, the Prop will be locked out and the Trim Up option will be disabled. The Prop will stay locked out even when the Deployment Menu has closed. Trim the motor down and out of the Prop Lockout region to restore functionality.
- g. When the lower trim limit is reached, the Trim Down option will be disabled.



### WARNING

While Trim Up or Trim Down is pressed, the motor will automatically trim. Be sure the motor is clear from obstructions and has a clear path of travel. The Prop is disabled while the motor is being trimmed to prevent accidental contact with the rotating Prop.



### WARNING

When trimming the motor, keep fingers clear of all hinges, pivot points and all moving parts.

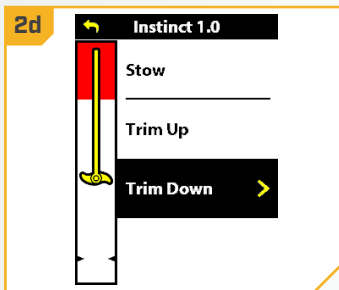
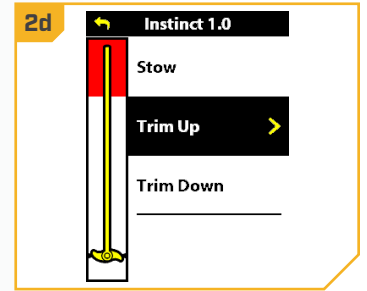
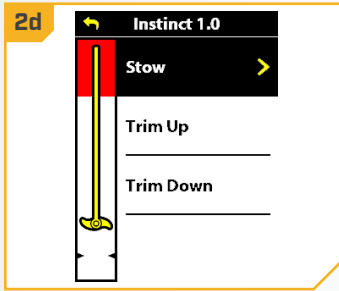

**NOTICE:** To avoid churning or agitation of surface water, ensure that the top of the motor is submerged at least 12" below the surface of the water.

**NOTICE:** The red area is the Prop Lockout region. The Prop will be automatically disabled if the lower unit is trimmed into this zone, and the Prop icon will turn gray. To restore Prop functionality, trim the lower unit out of the Prop Lockout region.



# TRIMMING WITH THE OBN APP

## ▶ Trimming with the OBN App

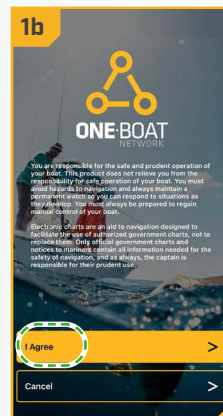
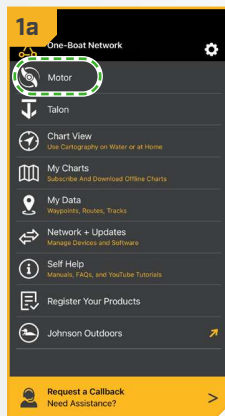

1

- Open the One-Boat Network (OBN) app on the mobile device. Make sure the mobile device is paired with the trolling motor.
- From the OBN home screen, tap the Motor menu. The Motor menu opens the Motor home screen.
- Before the Motor home screen will open, tap Agree on the on-screen prompt.



**NOTICE:** The on-screen prompt will only display once each time the app is launched. If the prompt has displayed, the Motor home screen appears after.

2

- Tap Trim/Stow on the bottom of the screen to open the Trim/Stow/Deploy menu.
- To trim the motor up, press and hold Trim Up . Continue to hold until the lower unit is at the desired height.
- To trim the motor down, press and hold Trim Down . Continue to hold until the lower unit is at the desired height.

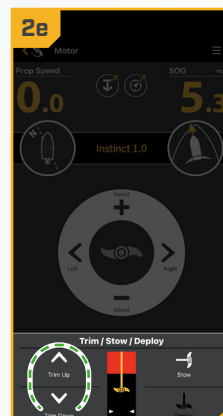
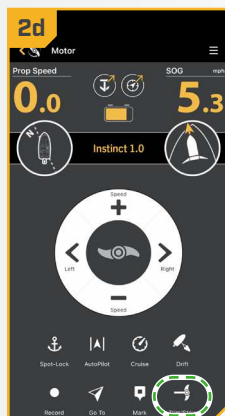

### **WARNING**

While Trim Up or Trim Down is pressed, the motor will automatically trim. Be sure the motor is clear from obstructions and has a clear path of travel. The Prop is disabled while the motor is being trimmed to prevent accidental contact with the rotating Prop.

### **WARNING**

When trimming the motor, keep fingers clear of all hinges, pivot points and all moving parts.

**NOTICE:** The red area is the Prop Lockout region. The Prop will be automatically disabled if the lower unit is trimmed into this zone, and the Prop icon will turn gray. To restore Prop functionality, trim the lower unit out of the Prop Lockout region.

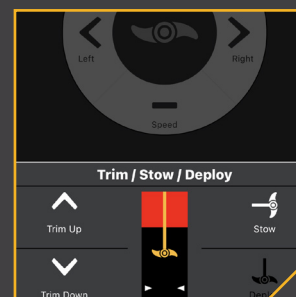

**NOTICE:** To avoid churning or agitation of surface water, ensure that the top of the motor is submerged at least 12" below the surface of the water.

## MOTOR ADJUSTMENTS >

### > Adjusting the Lift Belt

The Lift Belt assists in trimming the Lower Unit up and down. Slack may appear periodically in the Lift Belt along the Shaft of the motor. To maintain tension on the Lift Belt, the screw that holds tension on the Lift Belt may occasionally require small adjustments.

1

- a. Place the motor in the stowed position. Once stowed, turn the motor off.



## WARNING

Disconnect the motor from power to avoid accidental operation.

- b. Locate the Socket Head Cap Screw on the bottom of the Control Head, between the Coil Cord and Shaft. Adjust this Screw to increase tension on the Lift Belt.
- c. Using a 5/32" Allen Wrench, turn the Socket Head Cap Screw clockwise to tighten the Lift Belt. Tighten to 8–10 in-lb.

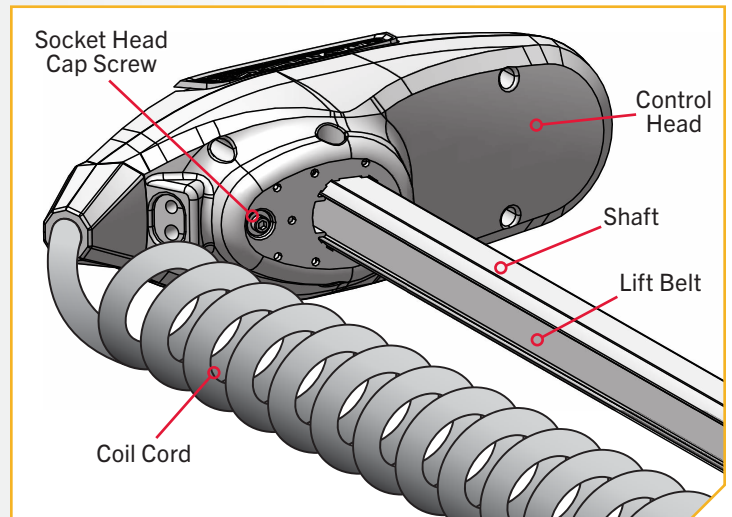

# MOTOR ADJUSTMENTS

## › Greasing the Tilt Shaft and Latch Pin

To maintain optimum performance of the Riptide Instinct QUEST, it is recommended that the Tilt Shaft and Latch Pin be greased every season. Minn Kota recommends using a marine-grade grease.

**1**

- a. Deploy the motor. Once deployed, turn the motor off.

### **WARNING**

Disconnect the motor from power to avoid accidental operation.

- b. Locate the Tilt Shaft near the center of the Mount, in the space between the Mount and Steering Housing.
- c. Apply a marine-grade grease to the exposed threads of the Tilt Shaft. Apply the grease sparingly.

**NOTICE:** Ensure that the space between the Mount and Steering Housing is clean and free of debris. The Mount has a Stow Pad that contacts the Steering Housing when stowed. The motor cannot stow securely if an obstruction is present on the Stow Pad.

**1c**

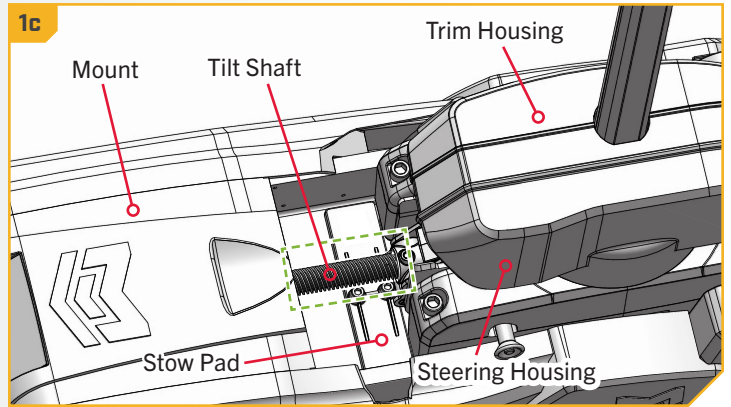

### **CAUTION**

When stowing and deploying the motor, keep fingers clear of all hinges, pivot points and all moving parts.

**2**

- d. Reconnect power to the motor. Turn the motor “on.”
- e. Stow the motor. Once stowed, turn the motor off.

### **WARNING**

Disconnect the motor from power to avoid accidental operation.

- f. Locate the Latch Pin at the bottom of the Steering Housing. The Latch Pin is part of the Latch Bracket Handle.
- g. Apply marine-grade grease to both ends of the Latch Pin to maintain optimal performance. Apply the grease sparingly to both ends of the Latch Pin where the Latch Pin contacts the Latch Bracket Handle.

### **CAUTION**

Do not engage the Latch Bracket Handle while greasing the Latch Pin to avoid pinch points.

**2g**

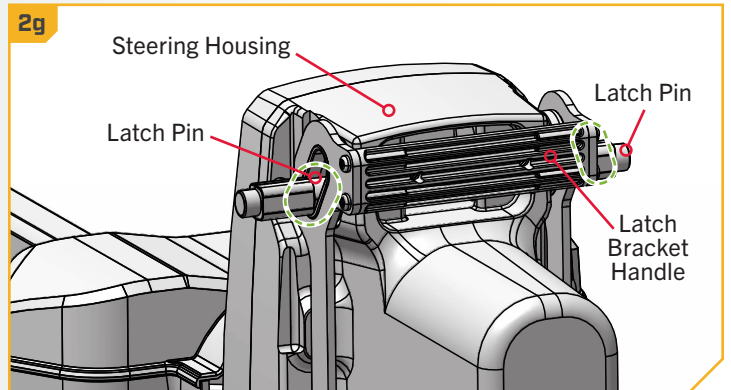

### **CAUTION**

When stowing and deploying the motor, keep fingers clear of all hinges, pivot points and all moving parts.

## › Installing an External Transducer

An external transducer is not included with your trolling motor. An external transducer can be installed onto motors that have Advanced GPS Navigation.

**1**

- a. Mount the External Transducer according to directions provided with the transducer.
- b. Leave enough slack in the Transducer Cable between the Lower Unit and Control Head to allow the motor to properly stow and deploy.
- c. Use two tie wrap cables to secure the Transducer Cable to the Shaft just above the Lower Unit and just below the Control Head.
- d. Run the Transducer Cable through the Coil Cord to the power supply.

### CAUTION

Failure to follow the recommended wire routing for the Sonar and External Transducer Cables may cause damage to the product and void your product warranty. Take care to test the length and placement of all cables to ensure that there is enough slack where needed and that cables are free of entanglement by moving parts. Routing the cables in any way other than as directed may cause damage to the cables via pinching or severing.

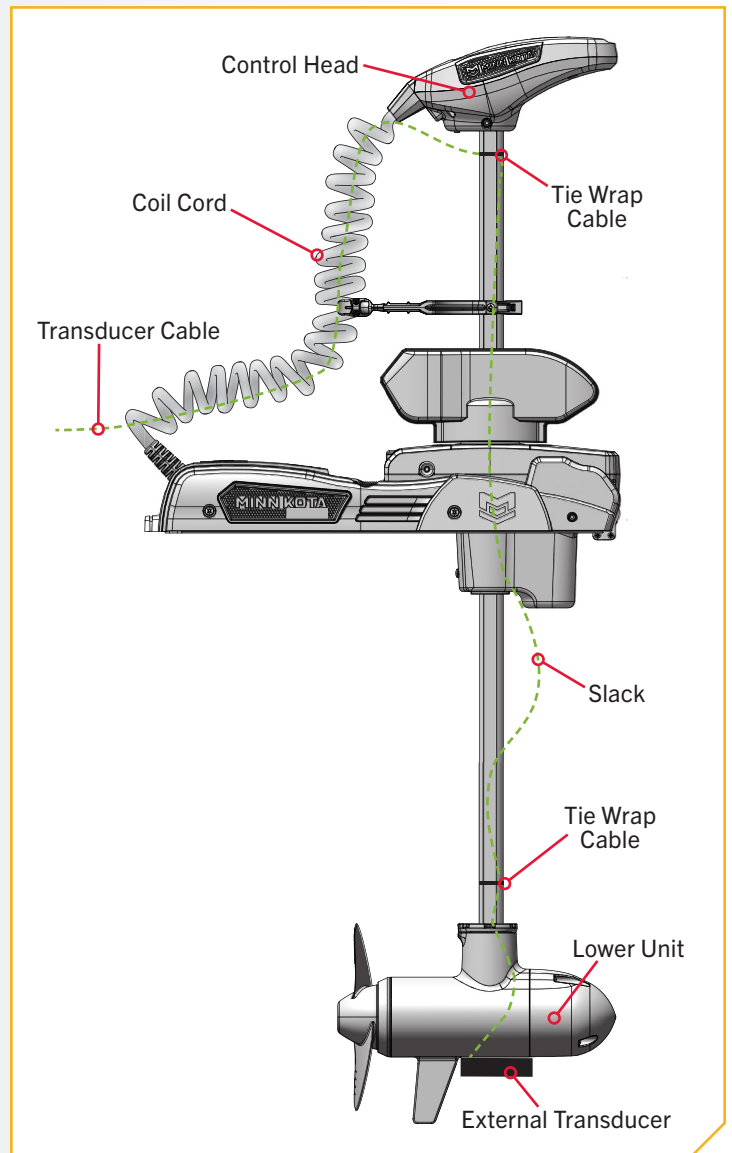

# EMERGENCY STOW PROCEDURES

## EMERGENCY STOW PROCEDURES >

In the unlikely event that the motor will not stow from the Wireless Remote or One-Boat Network app, the following alternative stow methods can be used to resolve the issue.

**NOTICE:** If the motor stalls when attempting to stow, the motor may be encountering an error. Check for obstructions or low motor batteries. If the batteries are too low to fully stow the motor, re-engage power, deploy the motor, trim the lower unit to its highest setting, and turn power off until batteries can be recharged. Once batteries are charged, attempt to stow the motor again.



## > Stowing from the Mount

In the unlikely event the Wireless Remote or One-Boat Network app becomes non-functioning, the motor can be stowed from the Indicator Panel at the base of the Mount.

1

### **WARNING**

During this procedure, the motor will go into an automated sequence. Keep fingers clear of all hinges, pivot points and all moving parts. Ensure that the motor or parts of the motor do not contact the boat, trailer, persons, or any other obstruction.

- a. Locate the Indicator Panel at the base of the Mount.
- b. Ensure that the motor is powered “on” by checking that the System Status  LED is illuminated blue.
- c. Press and hold the Power  button for 10 seconds.
- d. The blue and orange LEDs next to the System Status (blue) and Stowed (orange) Indicators will flash alternately, and the motor will begin to stow.

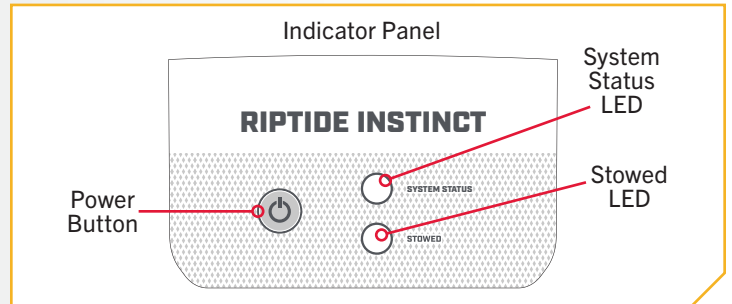

## MANUAL STOW BYPASS

If the motor loses power or will not stow by any other method, a Manual Stow Bypass procedure can be used to manually stow the motor. The Manual Stow Bypass involves two steps:

1. Manually Trim the Motor
2. Manually Stow the Motor

After completing both steps of the Manual Stow Bypass, return to shore and resolve the error or take the motor to a Minn Kota authorized service provider. Once the error has been resolved, see the “Manual Stow Bypass Recovery” section for instructions on restoring motor functions after an emergency stow.



Scan to find additional help.

## **WARNING**

While servicing the motor, stay clear of pinch points and do not wear loose-fitting clothing or loose-fitting jewelry.

## **CAUTION**

Once the motor has been manually stowed, it will be non-operational until it is manually recovered.

**NOTICE:** In the event of a Manual Stow Bypass, the Quick Release Pin is removed from the Steering Housing. To reinstall the Quick Release Pin and restore motor functions, the Steering Housing must be in the same position it was in when the Quick Release Pin was removed. Incorrect installation of the Quick Release Pin may cause severe damage to the motor. See the “Manual Stow Bypass Recovery” section for more information.

## › Manually Trim the Motor

1

## **WARNING**

Disconnect the motor from power to avoid accidental operation.

- a. With the motor deployed, locate the Trim Release Lever on the side of the Trim Housing.
- b. Firmly grasp the Shaft of the motor. While lifting up on the Shaft, open the Trim Release Lever.
- c. Manually trim the motor by pulling the Shaft upward. Stop lifting when there are approximately 10 inches of Shaft remaining below the Steering Housing.
- d. Rotate the Shaft so that the Prop faces Port. The Lower Unit should be perpendicular to the Mount.
- e. Close the Trim Release Lever to secure the Shaft in place.

## **WARNING**

Moving parts can cut or crush. When using the Trim Release Lever or moving the Shaft, keep fingers clear of all hinges, pivot points, and moving parts. Take care when mechanical parts are in motion.

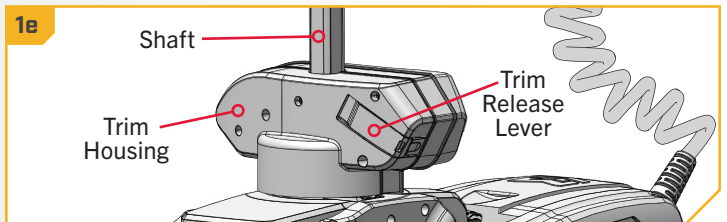
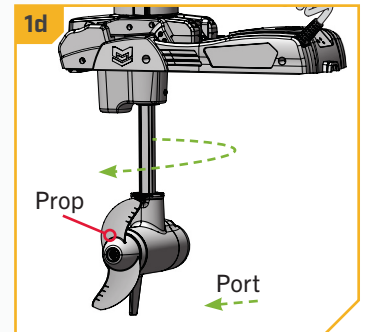
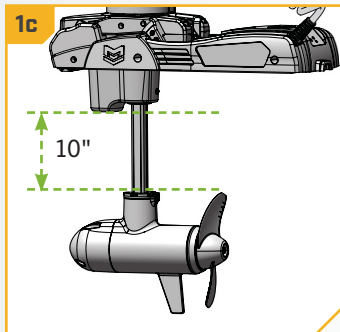
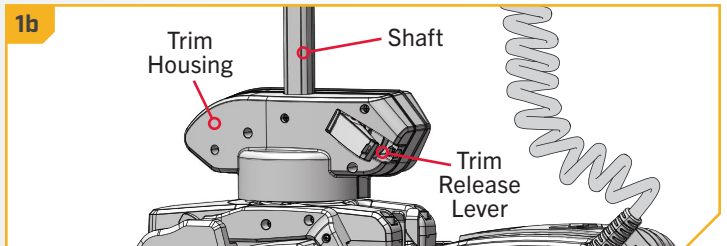

# MANUAL STOW BYPASS

## Manually Stow the Motor

1

**NOTICE:** Complete the Manual Trim before beginning this procedure.

- a. Locate the Quick Release Lever on the Steering Housing, above the Tilt Shaft near the center of the Mount. Open the Quick Release Lever by lifting upward.
- b. Locate the Quick Release Pin on the side of the Steering Housing. Push in the center of the Pin. While keeping the center of the Pin pushed in, pull the Pin completely out of the Steering Housing.

**NOTICE:** Do not lose the Quick Release Pin. The Motor cannot function without the Quick Release Pin.

- c. Locate the Latch Bracket Handle on the back of the Steering Housing, near the Motor Ramps.
- d. Firmly grasp the Shaft and raise the Latch Bracket Handle. While holding both the Shaft and Latch Bracket Handle, pivot the trolling motor into the stowed position.

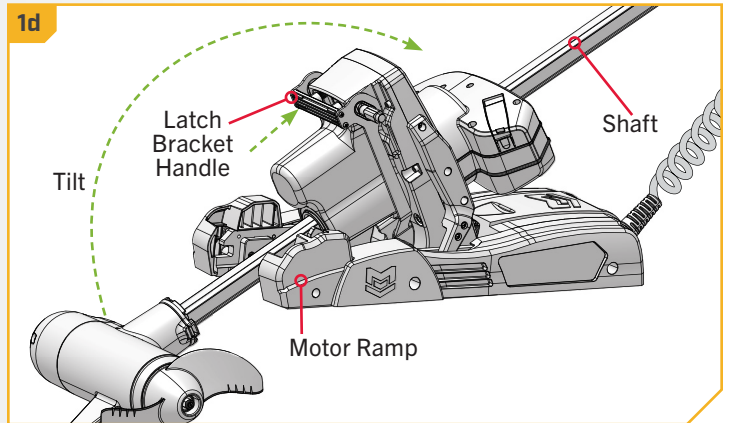
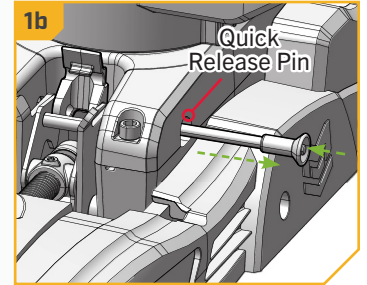
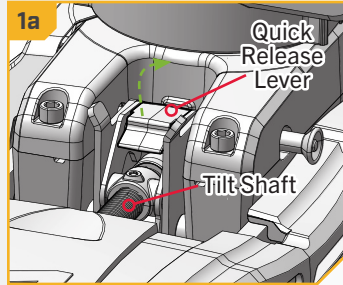

2

- e. With the motor in the stowed position, release the Latch Bracket Handle while maintaining a hold on the Shaft.
- f. Locate the Trim Release Lever on the side of the Trim Housing. While holding the Shaft, open the Trim Release Lever.
- g. Pull the Lower Unit fully onto the Motor Ramps. Secure the lower unit on the Motor Ramps and close the Trim Release Lever to lock the motor in the stowed position.

**NOTICE:** Once on shore, take the motor to an Authorized Service Provider or use the Minn Kota Help Center at [minnkota.johnsonoutdoors.com](http://minnkota.johnsonoutdoors.com).

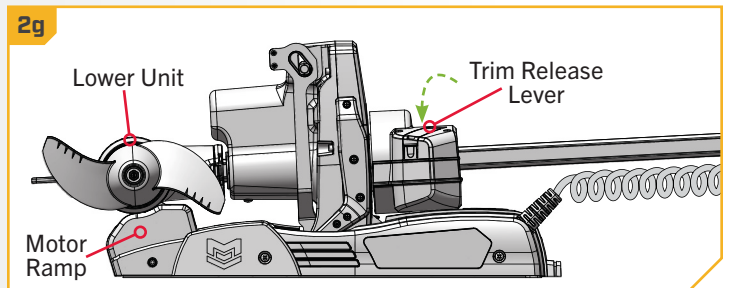
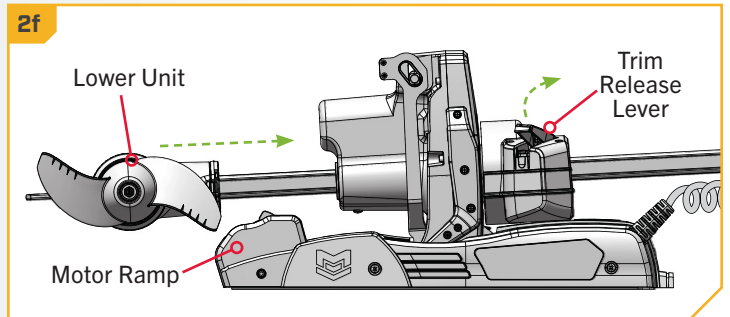

# MANUAL STOW BYPASS RECOVERY

## MANUAL STOW BYPASS RECOVERY

After completing a Manual Stow Bypass, most motor functions are disabled, and an error will display on the Wireless Remote. If the error that required an emergency stow is resolved, motor operation can be restored through a Manual Stow Bypass Recovery procedure. To recover from a Manual Stow Bypass, the motor must be manually deployed and the Quick Release Pin reinstalled.

### CAUTION

Once the motor has been manually stowed, it will be non-operational until the Manual Stow Bypass is recovered.

1

### WARNING

Disconnect the motor from power to avoid accidental operation.

- a. With the motor powered “off” and in the stowed position, locate the Trim Release Lever on the side of the Trim Housing. Firmly grasp the Shaft and open the Trim Release Lever.
- b. While holding the Shaft, slide the Lower Unit approximately 10 inches Outboard. Keep the Shaft horizontal to prevent the motor from tilting. When the Lower Unit is clear of the Motor Ramps, close the Trim Release Lever to lock the Shaft.
- c. While holding the Shaft and Steering Housing, pivot the motor into the deployed position. Guide the motor upright until the Latch Pin fully engages with the Motor Ramps.

### WARNING

Moving parts can cut or crush. Keep fingers clear of all hinges, pivot points, and moving parts when using the Trim Release Lever, moving the Shaft, or tilting the motor. Take care when mechanical parts are in motion.

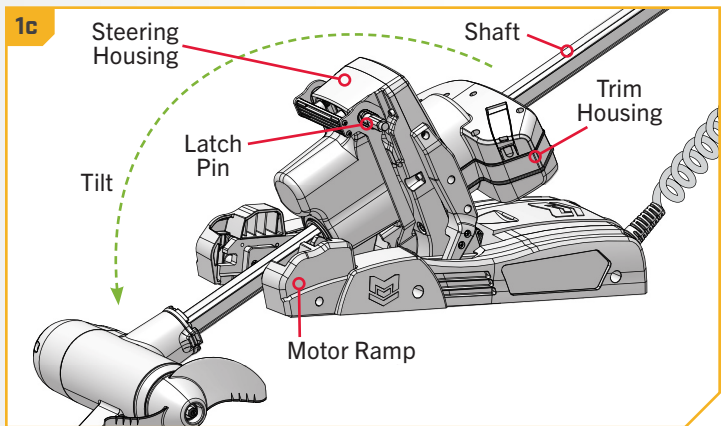
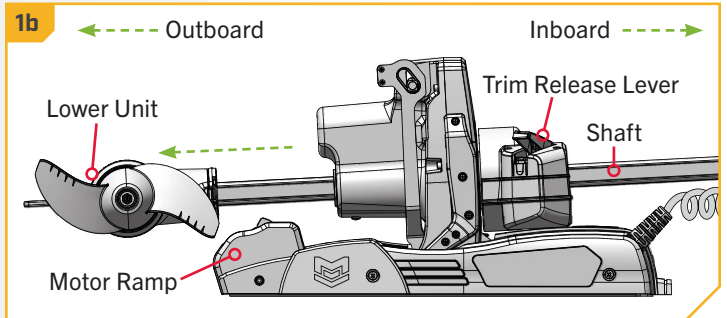

# MANUAL STOW BYPASS RECOVERY

2

- d. Take the Quick Release Pin that was removed during the Manual Stow Bypass.
- e. Locate the hole for the Quick Release Pin on the Port side of the Steering Housing.
- f. The Quick Release Pin must pass through four center plates between the Steering Housing to properly install. If the holes in the plates are not aligned, pull the Quick Release Lever to lift the plates. Realign the plates as needed to allow the Quick Release Pin to be completely inserted.
- g. Press and hold in the center of the Quick Release Pin. While pressing the center of the Pin, insert the Quick Release Pin into the Steering Housing. Ensure that the Quick Release Pin passes through all four plates and into the other side of the Steering Housing. The Quick Release Pin is fully inserted when the handle is seated against the Steering Housing. The retaining ball in the Quick Release Pin must be visible past the final plate.

**NOTICE:** If the Quick Release Pin is installed incorrectly and does not capture all four plates, severe motor damage may occur.

- h. With the Quick Release Pin fully inserted, lower the Quick Release Lever. Ensure the Lever is seated.

## ⚠ CAUTION

Watch for pinch points when closing the Quick Release Lever. Push on the back of the Quick Release Lever with an open palm to keep fingers clear of pinch points.

- i. Reconnect the motor to power. Normal motor operation may resume.

**NOTICE:** The Quick Release Pin must be fully inserted for the motor to function.

**NOTICE:** If the motor is nonfunctional after restoring power and reinstalling the Quick Release Pin, contact a Minn Kota authorized service provider.

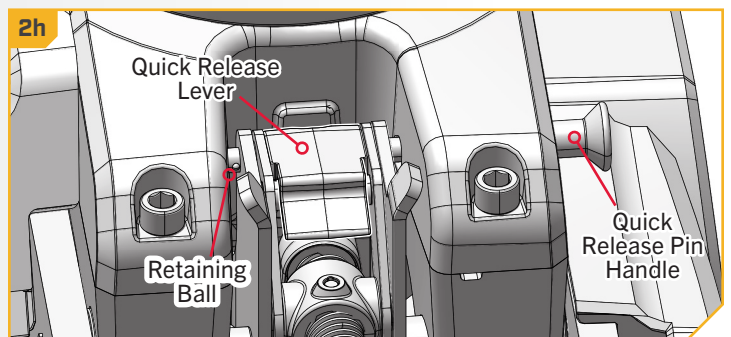
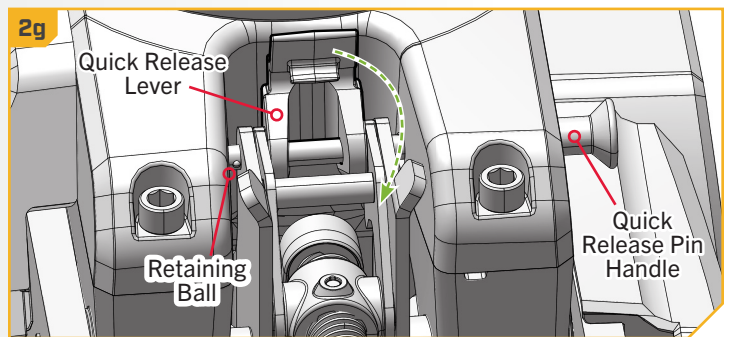
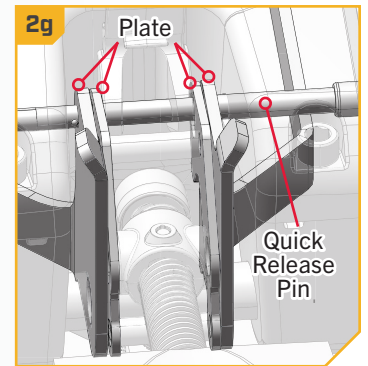
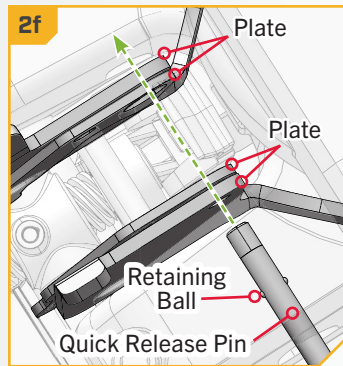
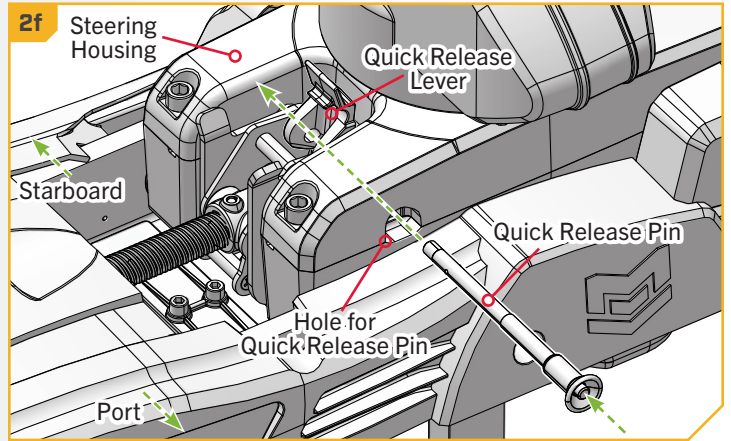

# SERVICE & MAINTENANCE

## PROP REPLACEMENT

### TOOLS AND RESOURCES REQUIRED >

- 9/16" Deep Well Socket

### INSTALLATION >

1

#### CAUTION

Disconnect the motor from all sources of power before beginning any prop work or maintenance.

- Hold the Prop and loosen the Prop Nut with a 9/16" Deep Well Socket.
- Remove the Prop Nut and Prop Washer.

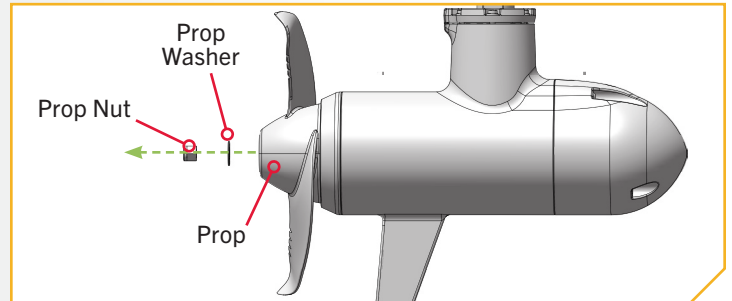

**NOTICE:** If the Drive Pin is sheared or broken, hold the Armature Shaft stationary with a Flat-Blade Screwdriver by pressing into the slot on the end of the shaft while loosening the Prop Nut.

2

- Turn the old Prop so it is horizontal and pull it straight off. If the Drive Pin falls out, push it back in.

#### CAUTION

If the Prop does not readily slide off, take care not to bend the Armature Shaft. Pull the Prop evenly off the Armature Shaft.

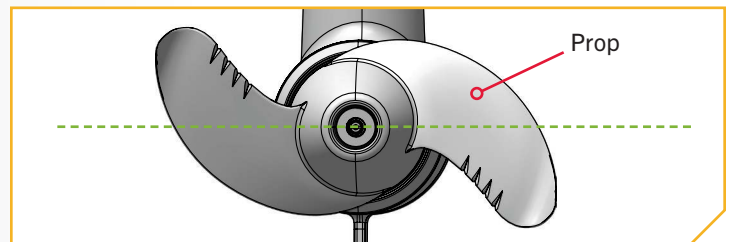

3

- Align the new Prop so it is horizontal and parallel with the Drive Pin. Slide the Prop onto the Armature Shaft and Drive Pin until it is seated against the lower unit.
- Reinstall the Prop Washer and Prop Nut onto the end of the Armature Shaft. While holding the Prop horizontal, tighten the Prop Nut with a 9/16" Deep Well Socket. Tighten the Prop Nut to 25-35 in-lbs.

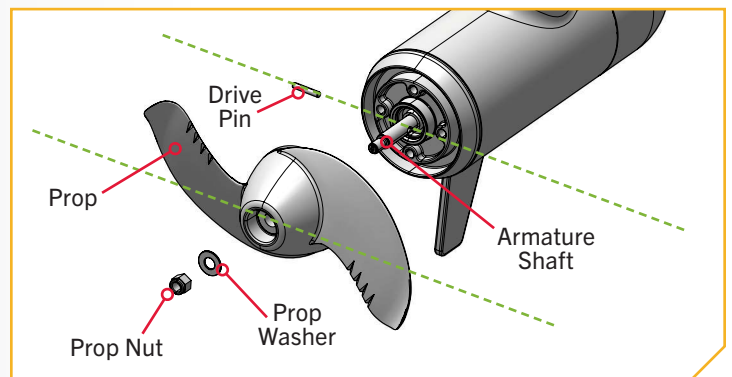

#### CAUTION

Do not over-tighten as this can damage the Prop.

# GENERAL MAINTENANCE



## GENERAL MAINTENANCE

- After use, the entire motor should be rinsed with freshwater.
- The composite shaft requires periodic cleaning and lubrication for proper retraction and deployment. A coating of an aqueous-based silicone spray will improve operation.
- The Prop must be inspected and cleaned of weeds and fishing line after every use. Fishing line and weeds can get behind the Prop, damage the seals and allow water to enter the motor.
- The Prop is designed to provide weed-free operation with very high efficiency. To maintain this top performance, the leading edge of the blades must be kept smooth. If they are rough or nicked from use, restore to smoothness by sanding with fine sandpaper.
- Verify that the Prop Nut is secure each time the motor is used.
- To prevent accidental damage during transportation or storage, disconnect the battery whenever the motor is off the water. For prolonged storage, lightly coat all metal parts with an aqueous-based silicone spray.
- When using lithium batteries, it is best to charge them right before using them. Storing lithium batteries in a fully charged state for long periods of time may cause damage to the batteries. Check with the battery manufacturer for specifics on the battery.
- For maximum battery life of all other batteries except lithium, recharge the battery(s) as soon as possible after use. For maximum motor performance, restore the battery to full charge prior to use. Check with the battery manufacturer for specifics on the battery.
- Keep battery terminals clean with fine sandpaper or emery cloth.
- Stow the motor after each use to allow water to drain from the Steering Housing. Water that sits in the steering housing when the motor is not in use may cause damage.
- When the motor is deployed, periodically check that the area between the Mount and Steering Housing is clean and free of debris. The Mount contains a Stow Pad that contacts the Steering Housing when stowed. If debris such as dirt, gravel, weeds, or fishing line enters this space, it may create an obstruction on the Stow Pad and prevent a secure stow. Periodically clean this space to ensure a secure stow.
- Periodically check the motor for loose hardware and damaged components.

## TROUBLESHOOTING

1. Motor fails to run or lacks power:
  - Check the state of the batteries and replace if necessary. Low battery voltage will cause an error.
  - Check battery connections for proper polarity.
  - Make sure the battery is charged.
  - Make sure terminals are clean and corrosion-free. Use fine sandpaper or emery cloth to clean terminals.
  - Check circuit protection devices.
  - Check battery water level. Add water if needed.
2. Motor loses power after a short running time:
  - Check battery charge. If low, restore to full charge, or replace.
3. You experience Prop vibration during normal operation:
  - Remove and rotate the Prop 180°. See removal instructions in the "Prop Replacement" section. Replace Prop if worn.
4. Experiencing interference with your fish finder:
  - You may, in some applications, experience interference in your fish finder display. We recommend that you use a separate deep cycle marine battery system for your trolling motor. If problems still persist, call our service department at 1-800-227-6433.



- 5. Motor contacts an object while trimming, causing an audible tone:
  - Reverse the direction of trimming to clear motor from obstruction.
- 6. Motor contacts an object while stowing, causing an audible tone:
  - Reverse the current cycle to clear the motor from the obstruction. Reverse the stow/deploy action with the wireless remote or One-Boat Network app.
- 7. Motor fails to trim:
  - Check main lift-belt tension per the "Motor Adjustments" section.
  - Conduct a Trim Reset procedure using the Indicator Panel at the base of the mount.
    - a. To conduct a Trim Reset, press the Power button on the Indicator Panel three times consecutively within a two-second period.
    - b. The blue System Status LED and orange Stowed LED will flash continuously while the Riptide Instinct QUEST goes through an automated sequence.
    - c. The motor will rotate into the Stow Orientation position.
    - d. The motor will trim up to the Mount and then trim down approximately six inches.
    - e. The flashing blue orange Stowed LED will turn off, and the flashing blue System Status LED will become solid blue.

WARNING

During the Trim Reset procedure, the motor will go into an automated sequence. Keep fingers clear of all hinges, pivot points and all moving parts. Ensure that the motor or parts of the motor do not contact the boat, trailer, persons, or any other obstruction.

- 8. Motor fails to stow or deploy:
  - Check for obstructions preventing the motor from deploying or stowing.
  - Check charge state of trolling motor batteries. If trolling motor battery icon on remote is flashing, battery charge is too low for operation.
  - If unable to stow by any other method, see the "Emergency Stow Procedures" section for details on manually stowing the motor.
- 9. Prop will not turn on:
  - Ensure batteries are sufficiently charged.
  - For safety reasons, there is a Prop Lockout Region (approx. 16" from bottom of Mount to center of Lower Unit). Ensure that the Lower Unit is not in this region.
- 10. Experiencing flashing red System Status  LED on the Indicator Panel:
  - The trolling motor is communicating that there is an error. Check the Wireless Remote Diagnostic menu for an error code, then refer to the Wireless Remote owner's manual for information on error codes and solutions. Correct the error and cycle power to the trolling motor. If the LED continues to flash red, please contact the Minn Kota service department.

**NOTICE:** For all other malfunctions, visit an Authorized Service Center. You can search for an Authorized Service Center in your area by visiting [minnkota.johnsonoutdoors.com](http://minnkota.johnsonoutdoors.com), or by calling our customer service number at 800-227-6433.

## FOR FURTHER TROUBLESHOOTING AND REPAIR



## FOR FURTHER TROUBLESHOOTING AND REPAIR

We offer several options to help you troubleshoot and/or repair your product. Please read through the options listed below.



### Buy Parts Online

You can buy parts online directly from our website at [minnkota.johnsonoutdoors.com](http://minnkota.johnsonoutdoors.com). From screws to sideplates, you can order replacement parts for your Minn Kota products.



### Frequently Asked Questions

Find answers to general inquiries, battery and rigging installation, and networking scenarios. We have FAQs available on our website at [minnkota.johnsonoutdoors.com](http://minnkota.johnsonoutdoors.com) to help answer all of your Minn Kota questions.



### Call Us (for U.S. and Canada)

Our consumer service representatives are available Monday – Friday between 7:00 a.m. – 4:30 p.m. CST at 800-227-6433. If you are calling to order parts, please have the 11-character serial number from your product, specific part numbers, and credit card information available. This will help expedite your call and allow us to provide you with the best consumer service possible. You can reference the parts list located in your manual to identify the specific part numbers.



### Contact Us

You can contact our consumer service department with questions regarding your Minn Kota products. To inquire, visit [minnkota.johnsonoutdoors.com](http://minnkota.johnsonoutdoors.com).



### Authorized Service Centers

Minn Kota has over 800 authorized service centers in the United States and Canada where you can purchase parts or get your products repaired. Please visit our website to locate a service center in your area.



Scan to visit  
Minn Kota  
service online.



# COMPLIANCE STATEMENTS

## ENVIRONMENTAL COMPLIANCE STATEMENT

It is the intention of JOME to be a responsible corporate citizen, operating in compliance with known and applicable environmental regulations, and a good neighbor in the communities where we make or sell our products.

### WEEE DIRECTIVE

EU Directive 2002/96/EC “Waste of Electrical and Electronic Equipment Directive (WEEE)” impacts most distributors, sellers, and manufacturers of consumer electronics in the European Union. The WEEE Directive requires the producer of consumer electronics to take responsibility for the management of waste from their products to achieve environmentally responsible disposal during the product life cycle.

WEEE compliance may not be required in your location for electrical & electronic equipment (EEE), nor may it be required for EEE designed and intended as fixed or temporary installation in transportation vehicles such as automobiles, aircraft, and boats. In some European Union member states, these vehicles are considered outside of the scope of the Directive, and EEE for those applications can be considered excluded from the WEEE Directive requirement.

This symbol (WEEE wheelee bin) on product indicates the product must not be disposed of with other household refuse. It must be disposed of and collected for recycling and recovery of waste EEE. Johnson Outdoors Inc. will mark all EEE products in accordance with the WEEE Directive. It is our goal to comply in the collection, treatment, recovery, and environmentally sound disposal of those products; however, these requirements do vary within European Union member states. For more information about where you should dispose of your waste equipment for recycling and recovery and/or your European Union member state requirements, please contact your dealer or distributor from which your product was purchased.



### DISPOSAL

Minn Kota motors are not subject to the disposal regulations EAG-VO (electric devices directive) that implements the WEEE directive. Nevertheless never dispose of your Minn Kota motor in a garbage bin but at the proper place of collection of your local town council.

Never dispose of battery in a garbage bin. Comply with the disposal directions of the manufacturer or his representative and dispose of them at the proper place of collection of your local town council.

## REGULATORY COMPLIANCE INFORMATION

### › Advanced GPS Navigation

For regulatory information on motors that come factory installed with Advanced GPS Navigation, please refer to the Advanced GPS Navigation Owner’s Manual online at [minnkota.johnsonoutdoors.com](http://minnkota.johnsonoutdoors.com).

# COMPLIANCE STATEMENTS



## FCC COMPLIANCE

This device complies with Part 15 of the FCC rules. **Operation is subject to the following two conditions:**

1. This device may not cause harmful interference.
2. This device must accept any interference that may be received, including interference that may cause undesired operation.

Changes or modifications not expressly approved by Johnson Outdoors Marine Electronics, Inc. could void the user's authority to operate this equipment.

**NOTICE:** This equipment has been tested and found to comply with the limits for a Class B digital device, pursuant to part 15 of the FCC Rules. These limits are designed to provide reasonable protection against harmful interference in a residential installation. This equipment generates, uses and can radiate radio frequency energy and, if not installed and used in accordance with the instructions, may cause harmful interference to radio communications. However, there is no guarantee that interference will not occur in a particular installation. **If this equipment does cause harmful interference to radio or television reception, which can be determined by turning the equipment off and on, the user is encouraged to try to correct the interference by one or more of the following measures:**

- Reorient or relocate the receiving antenna.
- Increase the separation between the equipment and receiver.
- Connect the equipment into an outlet on a circuit different from that to which the receiver is connected.
- Consult the dealer or an experienced radio/TV technician for help.

## INDUSTRY CANADA COMPLIANCE

This product meets the applicable Industry Canada technical specifications. Operation is subject to the following two conditions: (1) this device may not cause interference, and (2) this device must accept any interference, including interference that may cause undesired operation of the device.

## ENVIRONMENTAL RATINGS

Ambient operating temperature range: -10C to 50C

Ambient operating humidity range: 5% to 95%

Maximum operating altitude: 10,000 feet



# PARTS DIAGRAM & PARTS LIST

## RT INSTINCT QUEST - 90/115 THRUST - 24/36 VOLT - 60"/72"/87"/100" SHAFT

The parts diagram and parts list provides Minn Kota® WEEE compliance disassembly instructions. For more information about where you should dispose of your waste equipment for recycling and recovery and/or your European Union member state requirements, please contact your dealer or distributor from which your product was purchased. Tools required, but not limited to: flat head screwdriver, Phillips screwdriver, socket set, pliers, wire cutters.

### RT INSTINCT QUEST CONTROL HEAD >

#### > Control Head Parts Diagram

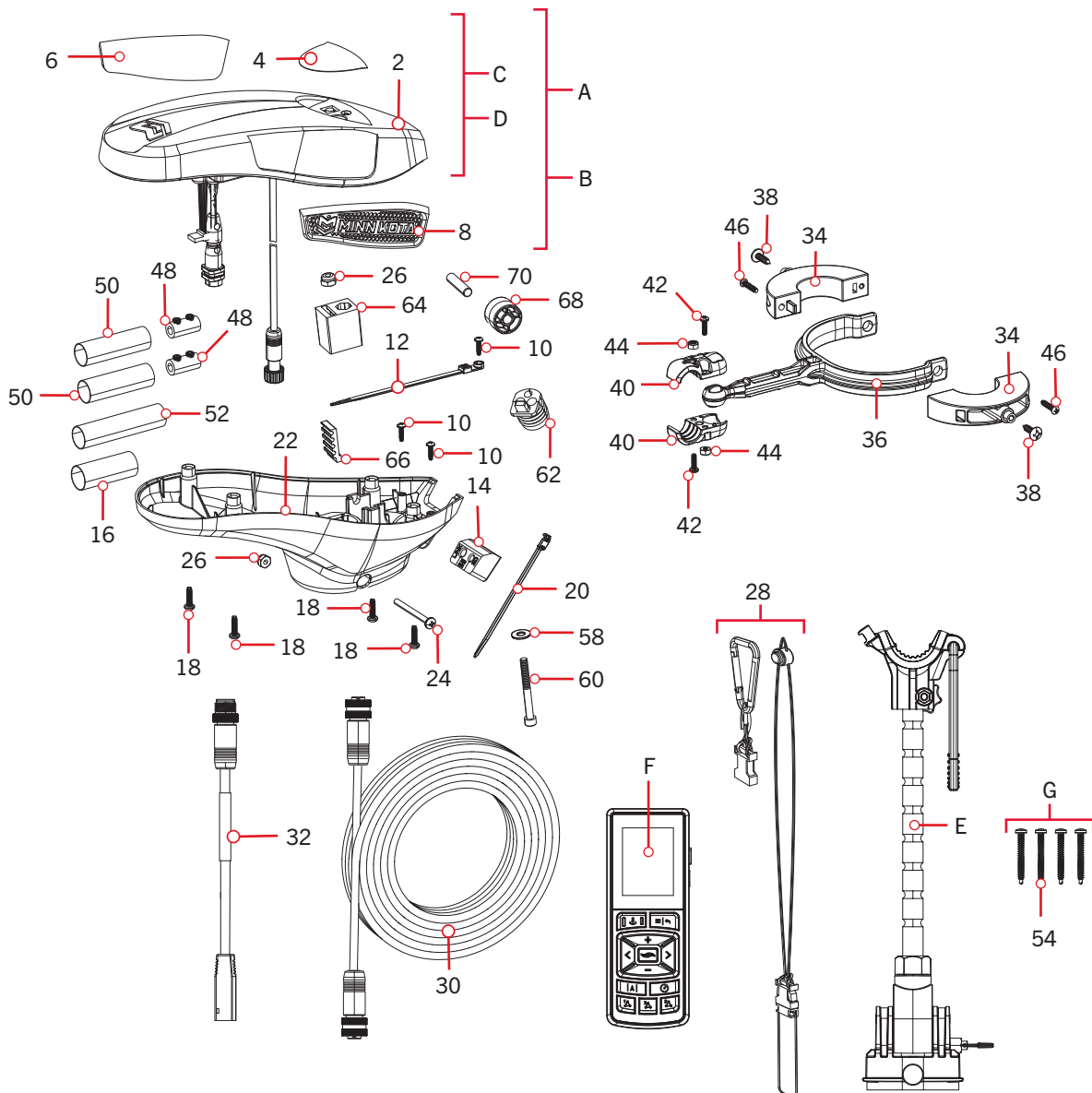

# PARTS DIAGRAM & PARTS LIST

## Control Head Parts List

Assembly	Part #	Description	Notes	Quantity
A	2994183	MTR KIT, 4.0 BL SW-BK WR	*RT INSTINCT QUEST* *SALTWATER BLACK*	1
B	2994194	MTR KIT, 4.0 BL SW WR	*RT INSTINCT QUEST* *SALTWATER WHITE*	1
C	2770248	CTRL BOX COVER QUEST SW WHT	*COVER & DECALS ONLY* *RT INSTINCT QUEST* *SALTWATER WHITE*	1
D	2770249	CTRL BOX COVER QUEST SW BLK	*COVER & DECALS ONLY* *RT INSTINCT QUEST* *SALTWATER BLACK*	1
E	2992371	STABILIZER, BWMT ES TM ASM	*72"* *87"* *100"*	1
F	411690-1	TROLLING MOTOR REMOTE		1
G	2994955	BAG, ASM MKA-60 STABILIZER	*72"* *87"* *100"*	1
Item	Part #	Description	Notes	Quantity
2	2200221	CONTROL BOX COVER, WHITE	*SALTWATER WHITE*	1
	2200220	CONTROL BOX COVER, BLACK	*SALTWATER BLACK*	1
4	2395561	DECAL,PUSH BTN, INST, WHT	*SALTWATER WHITE*	1
	2395595	DECAL, PUSH BTN, INSTINCT	*SALTWATER BLACK*	1
6	2205543	DECAL, CTRL BOX MK RIGHT SW		1
8	2205548	DECAL, CTRL BOX MK LEFT SW		1
10	2203441	SCREW-#6 X 1/2" THRD FORM,SSTL		3
12	2206302	TIE WRAP,SCREW MOUNT 6.3"		1
14	2206710	PLUG, RUBBER, DI/SI		1
16	2205412	SHRINK TUBE-.75 ID X 2"		1
18	2372100	SCREW-#8-18 X 5/8 THD* (SS)		4
20	2206301	TIE WRAP, LOW PROFILE 8"		1
22	2202521	CONTROL BOX BASE, ULTERRA SW	*SALTWATER WHITE*	1
	2202520	CONTROL BOX BASE, ULT,UTX, FW	*SALTWATER BLACK*	1
24	2263406	SCREW-#10-24 X 2" S/S PPH		1
26	2333101	NUT-HEX #10-24 UNC-2B NYL SS		2
28	2390802	LANYARD w/CARARBINER IP RMT U2		1
30	490637-4	CABLE, ETH, M12-M12, BRAID,30'		1
32	490380-1	CABLE, ETHERNET PIGTAIL-700 HD		1
34	2201530	COLLAR HALF, COIL CORD	*72"* *87"* *100"*	2
36	2201531	COLLAR ARM, COIL CORD	*72"* *87"* *100"*	1
38	2203424	SCREW-#10-12 x.75 PTH SS	*72"* *87"* *100"*	2
40	2200860	CLAMP-BALL,COIL CORD SLDR	*72"* *87"* *100"*	2
42	830-065	SCREW-#6-32 X 1/2" TORX PH SS	*72"* *87"* *100"*	2
44	2323110	NUT-HEX, 6-32 NYLOK SS	*72"* *87"* *100"*	2
46	2203460	SCREW-#8 X 0.75 PPH HI-LO SS	*72"* *87"* *100"*	2
48	2375444	SPLICER, 6-10 AWG, TIN PLTD		2
50	2205413	SHRINK TUBE-3/4 X 2.25"		2
52	2205410	SHRINK TUBE-.472 ID X 4"		1

▲ Not shown on Parts Diagram.

\* This part is included in an assembly and cannot be ordered individually.

# PARTS DIAGRAM & PARTS LIST



Item	Part #	Description	Notes	Quantity
54	2383475	SCREW - #8-18 X 1 1/2 SELF DR SS	*72"* *87"* *100"*	4
58	2201721	WASHER - #10 SAE.I, SS		1
60	2203411	SCREW-#10-24,SHCS,SS, RIE 4606		1
62	2206721	PLUG-WIRE, ROUND	*87"* *100"*	1
64	2202800	BLOCK-BELT		1
66	2200800	BELT-RACK, LOWER		1
68	2202335	PULLEY, BELY TOP		1
70	2202635	PIN-DOWEL, 1/4" OD SS		1
▲	2207127	MANUAL, INSTINCT		1
▲	2207128	MANUAL, INSTL GD, INSTINCT		1
▲	2297165	MANUAL-DISCLAIMER,DWNLOAD INFO		1
▲	2294950	INSTRUCTIONS,OBV & REMOTE PAIR		1
▲	2397115	GUIDE-QUICK REFERENCE iP 4.0		1
▲	2397110	MANUAL, iPILOT 4.0		1
▲	2207130	BRUSHLESS QS SETUP GUIDE		1
▲	2207126	QK REF GUIDE,ULT Q/INST Q		1
▲	2395540	DECAL, COMPLIANCE, KIT 1.6, 3.0		1
▲	2377179	INSTR. SHEET, MKA-60 STABILIZER	*72"* *87"* *100"*	1
▲	2206819	LABEL-CARTON "CAUTION HEAVY"		1

▲ Not shown on Parts Diagram.

✘ This part is included in an assembly and cannot be ordered individually.



# PARTS DIAGRAM & PARTS LIST



## RT INSTINCT QUEST MOTOR

### 24/36 Volt 90/115 Thrust Motor Parts Diagram

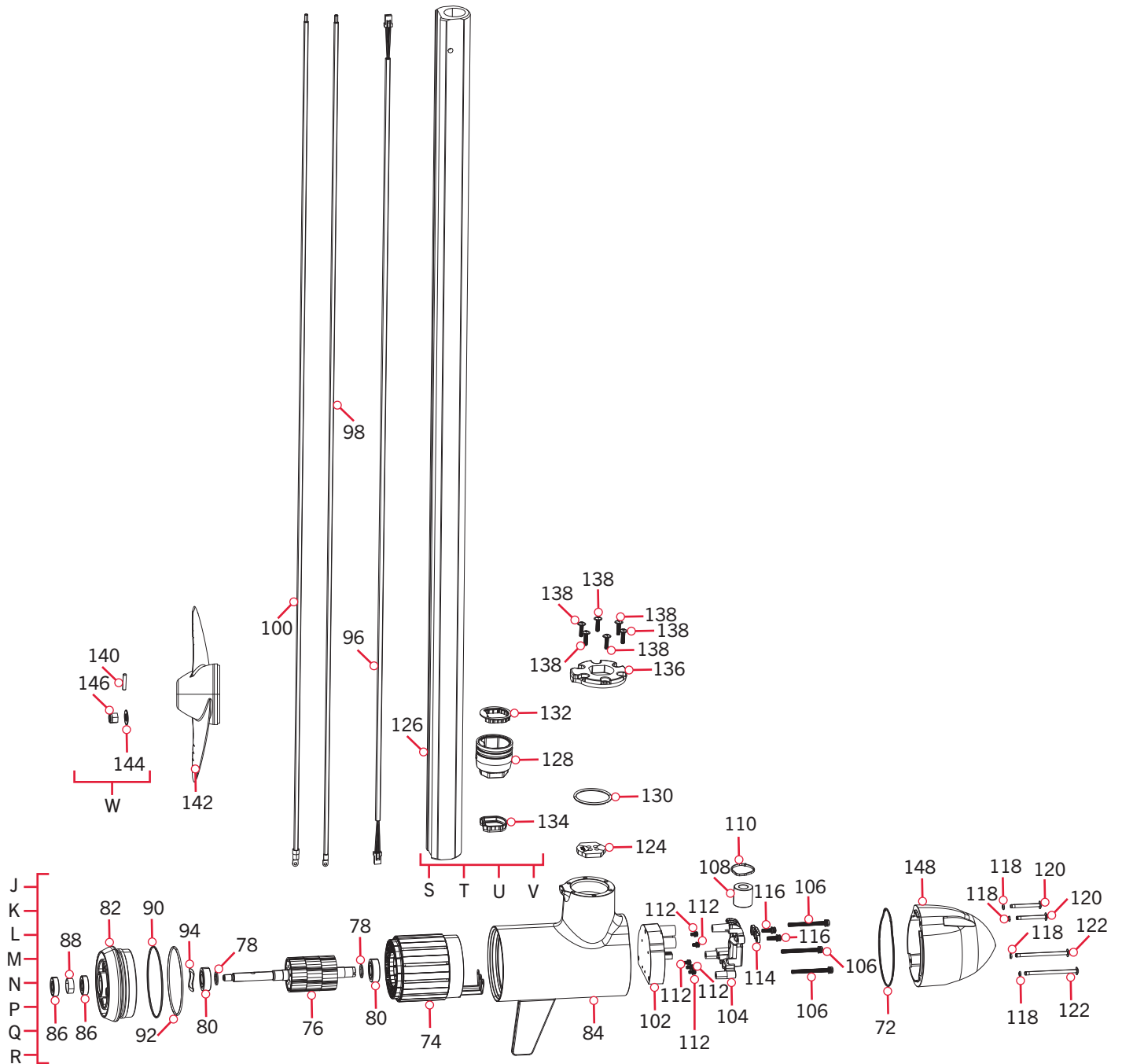

## PARTS DIAGRAM & PARTS LIST

### ▶ 24/36 Volt 90/115lb Thrust Motor Parts List

Assembly	Part #	Description	Notes	Quantity
J	2441050	MTR ASY 90/115# NS SW WHT 60"	*60"* *SALTWATER WHITE*	1
K	2441051	MTR ASY 90/115# NS SW WHT 72"	*72"* *SALTWATER WHITE*	1
L	2441052	MTR ASY 90/115# NS SW WHT 87"	*87"* *SALTWATER WHITE*	1
M	2441053	MTR ASY 90/115# NS SW WHT 100"	*100"* *SALTWATER WHITE*	1
N	2441055	MTR ASY 90/115# NS SW BLK 60"	*60"* *SALTWATER BLACK*	1
P	2441056	MTR ASY 90/115# NS SW BLK 72"	*72"* *SALTWATER BLACK*	1
Q	2441057	MTR ASY 90/115# NS SW BLK 87"	*87"* *SALTWATER BLACK*	1
R	2441058	MTR ASY 90/115# NS SW BLK 100"	*100"* *SALTWATER BLACK*	1
S	2991065	SHAFT ASM 60" U2,T3 *60"*	*SHAFT* *60"*	1
T	2991051	SHAFT ASM 72"INST,RT/T3 *72"*	*SHAFT* *72"*	1
U	2991052	SHAFT ASM 87"INST,RT/T3 *87"*	*SHAFT* *87"*	1
V	2991053	SHAFT ASM 100"INS,RT/T3 *100"*	*SHAFT* *100"*	1
W	2992604	BAG ASSM, PROP HARDWARE		1
Item	Part #	Description	Notes	Quantity
72	880-032	SEAL-FRONT, BL MOTORS		1
74	✘	STATOR ASSEMBLY		1
76	✘	ROTOR ASSEMBLY		1
78	✘	WASHER BEARING		2
80	✘	BALL BEARING		2
82	✘	REAR ENDBELL, SW WHT PAINT	*SALTWATER WHITE*	1
	✘	REAR ENDBELL, SW PAINT BLACK	*SALTWATER BLACK*	1
84	✘	CENTER HSG, SW WHT PAINT	*SALTWATER WHITE*	1
	✘	CENTER HSG, SW BLACK PAINT	*SALTWATER BLACK*	1
86	✘	SEAL		2
88	✘	PAPER TUBE - SEAL BORE		1
90	✘	O-RING		1
92	✘	O-RING		1
94	✘	WASHER-WAVE		1
96	195-032	CABLE-COM 22GA TWST PAIR 76.25	*60"*	1
	195-033	CABLE-COM 22GA TWST PAIR 87.63	*72"*	1
	195-034	CABLE-COM 22G TWST PAIR 102.63	*87"*	1
	195-035	CABLE-COM 22G TWST PAIR 111.38	*100"*	1
98	640-472	LEADWIRE RED 8 AWG 78.75"	*60"*	1
	640-483	LEADWIRE RED 6 AWG 90.13"	*72"*	1
	640-484	LEADWIRE RED 6 AWG 105.13"	*87"*	1
	640-485	LEADWIRE RED 6 AWG 118.13"	*100"*	1

▲ Not shown on Parts Diagram.

✘ This part is included in an assembly and cannot be ordered individually.

# PARTS DIAGRAM & PARTS LIST



Item	Part #	Description	Notes	Quantity
100	640-422	LEADWIRE BLK 8 AWG 78.75"	*60"	1
	640-433	LEADWIRE BLK 6 AWG 90.13"	*72"	1
	640-434	LEADWIRE BLK 6 AWG 105.13"	*87"	1
	640-435	LEADWIRE BLK 6 AWG 118.13"	*100"	1
102	2994130	INVERTER ASM, 24/36V, BL		1
104	979-031	STRAIN RELIEF,BTM MACH WIRETAB		1
106	830-118	SCREW-DBL SEM M5X.8MMX60MM		3
108	2307318	FERRITE BEAD, BL		1
110	9953310	TIE WRAP-8"		1
112	830-120	SCREW-M4X .7X8 PPH ZPS		5
114	979-022	STRAIN RELIEF, TOP CAST		1
116	830-121	SCREW-M5 X .8X18 PPH ZPS		2
118	701-010	O-RING, SCREW		4
120	830-115	SCREW-FRONT, TOP, COATED, BL MTR		2
122	830-116	SCREW-FRONT, BTM COATED, BL MTR		2
124	880-042	SEAL-WIRE, BL MTR, PLAIN END		1
126	✘	TUBE-1CM, BLK 60", 1.5 X .875	*60"	1
	✘	TUBE-5CM, BLK 72", 1.5 X .75	*72"	1
	✘	TUBE-5CM, BLK 87", 1.5 X .75	*87"	1
	✘	TUBE-5CM, BLK 100", 1.5 X .75	*100"	1
128	✘	PLUG, COMP SHAFT, PAINTED		1
130	2294630	O-RING, 226, 70 SHORE A		1
132	✘	SEAL-TOP SHAFT, BRUSHLESS, CLR		1
134	✘	SEAL-LWR SHAFT, BRUSHLESS, CLR		1
136	2206452	PLATE, CLAMP, PAINTED, BELT		1
138	830-013	SCREW-M5 X .8 FSHCS SS CTD		6
140	2262659	PIN-DRIVE 1" X 3/16" SS 17-4		1
142	2321170	PROP, POWER REAMED		1
144	2091701	WASHER-PROP (LARGE) MAX101		1
146	2093101	NUT-PROP,NYLOC,LG,MX101 3/8 SS		1
▲	2005764	DECAL, SERIAL NO, BL LWR UNT		1
148	421-168	FRONT ENDBELL, PLAIN, SW WHT PNT	*SALTWATER WHITE*	1
	421-169	FRONT ENDBELL, PLAIN, SW BLACK	*SALTWATER BLACK*	1

▲ Not shown on Parts Diagram.

✘ This part is included in an assembly and cannot be ordered individually.



RT INSTINCT QUEST STEERING HOUSING

Steering Housing Parts Diagram

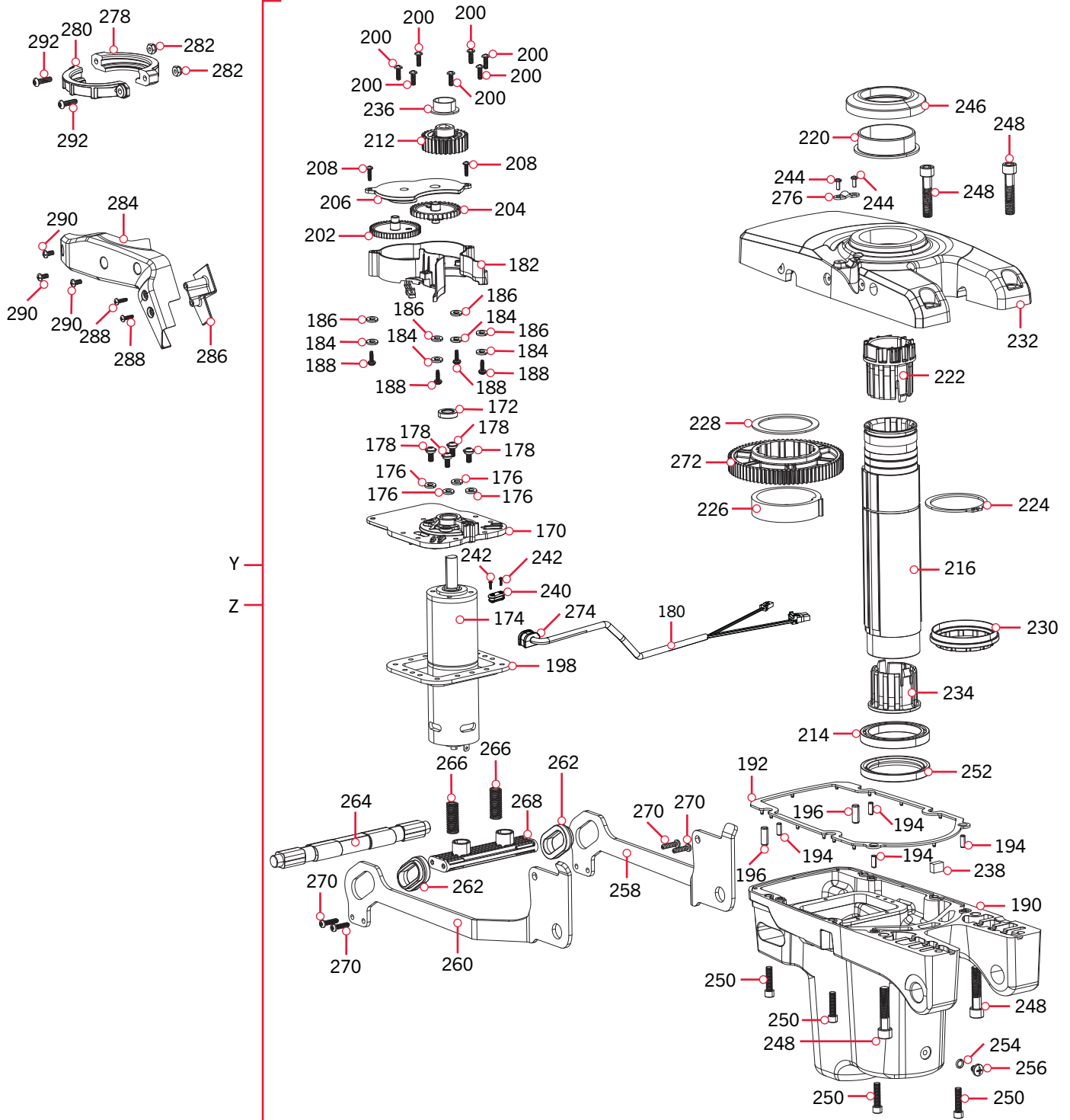

# PARTS DIAGRAM & PARTS LIST

## › Steering Housing Parts List

Assembly	Part #	Description	Notes	Quantity
Y	2996531	ASM, STEERING, SW, WHT	*SALTWATER WHITE*	1
Z	2996532	ASM, STEERING, SW BLK	*SALTWATER BLACK*	1
Item	Part #	Description	Notes	Quantity
170	2206401	PLATE, MOTOR MNT, STEERING		1
172	2204640	SEAL, ID 12MM, OD 20MM, T 5MM		1
174	2207012	MOTOR, 24 VDC, 1:130 GEARBOX		1
176	2204617	O-RING, 3/16 ID X 3/8 OD		4
178	2203414	SCREW-M5X.8X12, FLANGED BTN HD		4
180	2200602	STEERING CORD ASM		1
182	2204040	SENSOR, STEERING, ROTATIONAL, I/T		1
184	2374628	SEALING WASHER, RUBBER		4
186	2071714	WASHER-FLAT #6 S/S		4
188	2203441	SCREW-#6 X 1/2" THRD FORM, SSTL		4
190	2326568	HSG-BTM, STRING, SW, WHT	*SALTWATER WHITE*	1
	2206575	HSG-BTM, STEERING, SW, BLK	*SALTWATER BLACK*	1
192	2204621	SEAL, STEERING HOUSING SPLIT		1
194	2202619	PIN-DOWEL, 3/16 X 1/2, SS		4
196	2382682	PIN-DOWEL, 1/4" X 5/8" SS		2
198	2206920	GASKET, MOTOR HOUSING, STEERING		1
200	2332101	SCREW-#8-32 X 1/2 (SS)		7
202	2992225	GEAR-STEER SENSOR, 51T, w/MAGNET		1
204	2202214	GEAR-TRIM, 14T		1
206	2206572	COVER, STEER SENSOR GEARS		1
208	2203441	SCREW-#6 X 1/2" THRD FORM, SSTL		2
210 ▲	9950433	TIE WRAP-4" BLACK(#21041)		1
212	2202212	GEAR, 30 TOOTH, PINION, STEERING		1
214	2207302	BRG, 55 X 72 X 9MM, SSTL		1
216	2202000	OUTPUT TUBE, ANDIZED		1
218 ▲	2204606	O-RING, -139, NOM ID 2.25,		1
220	2207320	BUSHING, 55MM, JFM-5560-50		1
222	2207321	BUSHING, OUTPUT TUBE, TOP, INSTNC		1
224	2293001	RETAINING RING, 2 3/8"		1
226	2207911	HUB, STEERING STOP, ANODIZED		1
228	2201715	WASHER-THRUST, OUTPUT TUBE		1
230	2205910	GREASE CAP BEARING		1
232	2206563	HSG-TOP, STEERING, SW, WHT	*SALTWATER WHITE*	1
	2206559	HSG-TOP, STEERING, SW BLK	*SALTWATER BLACK*	1

▲ Not shown on Parts Diagram.

\* This part is included in an assembly and cannot be ordered individually.

# PARTS DIAGRAM & PARTS LIST



Item	Part #	Description	Quantity
234	2207345	BUSHING, OUTPUT TUBE, LOWER	1
236	2207340	BUSHING, JFM-2023-11	1
238	2208640	VENT FILTER, STEERING HOUSING	1
240	2201941	MNT, SENSOR, LATCH QRP	1
242	2373440	SCREW-#4-24 X 1/4 PHCR SS TY B	2
244	2293403	SCREW-#6-32 X .625 PPH SS	1
246	2204642	SEAL, UMBRELLA	1
248	2203453	SCREW-3/8-16 X 1.75 SHCS SS NYSHD	4
250	2323436	SCREW-1/4-20 X 1" SHC, SS NYSHIELD	4
252	2294601	SEAL, OUTPUT	1
254	2204618	O-RING, SAE-010, BUNA-N	1
256	2203429	SCREW-1/4-20 X .313 PLASTIC	1
258	2201925	BRACKET, LATCH RELEASE, RIGHT	1
260	2201926	BRACKET, LATCH RELEASE, LEFT	1
262	2207306	BUSHING, LATCH PIN	2
264	2202624	PIN-LATCH, OVERMOLDED	1
266	2202705	SPRING, COMPRESS, 1.25 L, 0.63 CMP	2
268	2207210	HANDLE, LATCH BRACKET	1
270	3393481	SCREW-#10X.75" PPH HI-LO (SUB)	4
272	2202210	GEAR, 78 TOOTH, OUTPUT TUBE	1
274	2202920	GROMMET, QRP SENSER HARNESS	1
276	2207410	HARNESS, QRP SNSR, HALL EFF	1
278	2200845	CLAMP, TRIM-STEER, L, MACH	1
280	2200846	CLAMP, TRIM-STEER, R, MACH	1
282	2333101	NUT-HEX #10-24 UNC-2B NYL SS	2
284	2206412	COVER, CABLE, STEER HOUSING BLACK	*SALTWATER BLACK*
	2206416	COVER, CABLE, STEER HSG, WHT	*SALTWATER WHITE*
286	2206413	BACKING, CABLE COVER	1
288	2203441	SCREW-#6 X 1/2" THRD FORM, SSTL	2
290	2332100	SCREW-#8-32 X 3/8 MACHINE	3
292	2383469	SCREW-#10-24 X 3/4, SS, BHCS	2

▲ Not shown on Parts Diagram.

✘ This part is included in an assembly and cannot be ordered individually.





# PARTS DIAGRAM & PARTS LIST

## Trim Housing Parts List

Assembly	Part #	Description	Notes	Quantity
AA	2997853	ASM, TRIM MOD,SW, WHT,60"	*60"* *SALTWATER WHITE*	1
BB	2997854	ASM, TRIM MOD,SW, WHT,72"	*72"* *SALTWATER WHITE*	1
CC	2997855	ASM, TRIM MOD,SW, WHT,87"	*87"* *SALTWATER WHITE*	1
DD	2997859	ASM, TRIM MOD,SW, WHT,100"	*100"* *SALTWATER WHITE*	1
EE	2997856	ASM, TRIM MOD,SW, BLK,60"	*60"* *SALTWATER BLACK*	1
FF	2997857	ASM, TRIM MOD,SW, BLK,72"	*72"* *SALTWATER BLACK*	1
GG	2997858	ASM, TRIM MOD,SW, BLK,87"	*87"* *SALTWATER BLACK*	1
HH	2997860	ASM, TRIM MOD,SW, BLK,100"	*100"* *SALTWATER BLACK*	1
Item	Part #	Description	Notes	Quantity
320	2206584	HOUSING-MID,TRIM, SW, WHT	*SALTWATER WHITE*	1
	2206579	HOUSING-MID, TRIM, SW BLK	*SALTWATER BLACK*	1
322	2204632	SEAL,LIP,3/4 ID X 1 OD X 1/8 L		1
324	2073414	SCREW-#6-32 X .375 PPH SS(N/A)		2
326	2207335	BUSHING, FLANGED, 3/4 SHAFT		1
328	2205126	BUMPER, WEAR, TRIM		2
330	2207916	HUB, TRIM PULLEY, ANODIZE		1
332	2204631	SEAL,LIP,5/16 ID X 3/4 ODX1/4L		1
334	2203030	RING, RETAIN, TRIM COUNT		1
336	2201727	WASHER, SLIP, TRIM		1
338	2202355	PULLEY, 38T, 1062-20 GROB IN		1
340	2202235	GEAR, PINION, TRIM COUNT		1
342	2202312	SPLINE SHAFT, PULLEY,TRIM		1
344	2201726	WASHER,ID .281, OD .75, T .075		1
346	2203032	RETAINING RING, 1/4"		1
348	2991263	TRIM CORD ASM		1
350	2204619	O-RING, HEYCO, 12X2MM, BUNA-N		1
352	2203102	NUT, PG 9, STRAIN RELIEF		1
354	2204041	SENSOR, TRIM, ROTATIONAL, I		1
356	2202222	GEAR, 12T/35T		1
360	2202223	GEAR, 13T/40T		1
362	2992224	GEAR-TRIM SENSOR,48T, w/MAGNET		1
364	2203500	BOLT-SHOULDER, #8-32 THD, SSTL		2
366	2206442	CAP, TRIM MAGNET SENSOR GEAR		1
368	2372103	SCREW-#6 X .375 PLASTITE SS		1
370	2997014	MOTOR, TRIM, 42MM, RIGHT ANGLE		1
372	2293417	SCREW-1/4-20 X 1.50" BHCS SS		3
374	2206926	GASKET, INSTINCT, TRIM		1

▲ Not shown on Parts Diagram.

\* This part is included in an assembly and cannot be ordered individually.

# PARTS DIAGRAM & PARTS LIST



Item	Part #	Description	Notes	Quantity
376	2202619	PIN-DOWEL, 3/16 X 1/2, SS		2
378	2206589	HSG-MTR CVR, TRIM,SW, WHT	*SALTWATER WHITE*	1
	2206590	HSG-MTR CVR, TRIM, SW BLK	*SALTWATER BLACK*	1
380	2203423	SCREW-#10-24 x .75, SHCS, SS		17
382	2205130	VENT PATCH, YLW/BLK		1
384	2202352	PULLEY-IDLER, TRIM, REAMED		2
386	2201736	WASHER, PLASTIC, .265 ID, .5 OD		4
388	2202610	PIN, BELT PULLEY		2
390	2204635	SEAL, 1/16 O-RING CORD, SILICONE		1
392	2201521	COLLAR, OUTPUT TUBE, MACH		1
394	2207336	BUSHING, FLANGED, 1.0 SHAFT		1
396	2200115	LEVER, TRIM RELEASE, MACH.		1
398	2202670	PIN, KNURL, HEAD, 4MM X 8MM		2
400	2202639	PIN-DOWEL, 1/4 X 1.75 LG		1
402	2200818	BELT-LIFT 5MM HTD		1
404	2206523	TRIM HOUSING, OD COVER SW		1
	2206524	TRIM HOUSING, OD COVER FW		1
406	2383469	SCREW-#10-24 X 3/4, SS, BHCS		5
408	3393481	SCREW-#10X.75" PPH HI-LO (SUB)		2
410	2200850	CLAMP, TRIM CABLE		1
412	2073414	SCREW-#6-32 X .375 PPH SS(N/A)		2

▲ Not shown on Parts Diagram.

✘ This part is included in an assembly and cannot be ordered individually.





# PARTS DIAGRAM & PARTS LIST

## Mount Parts List

Assembly	Part #	Description	Notes	Quantity
JJ	2994948	BAG, ASM, INSTINCT, T3 BL HDW		1
Item	Part #	Description	Notes	Quantity
430	2372103	SCREW-#6 X .375 PLASTITE SS		2
432	2201907	BASE, MACHINED, SW		1
434	2205106	PAD, DEAD STOP, STOW		1
436	2373434	SCREW-1/4-20 X 3/4 SS PPMS		2
438	2205518	DECAL-INSTRUCTIONS, TRIM BYPASS		1
440	2323211	STOP-DEAD, DEPLOY		2
442	2383469	SCREW-#10-24 X 3/4, SS, BHCS		6
444	2202907	STANDOFF, .5 ODX.19 IDX.44 L, PL		1
446	2333101	NUT-HEX #10-24 UNC-2B NYL SS		1
448	2203426	SCREW-#10-24 x 1.5 SS BHCS		1
450	2200828	CLIP-CORD BACKUP MT PLATE		1
452	2200829	CLIP-CORD MT BRACKET		1
454	2991245	COIL CORD ASM 45" - 60"	*60"	1
	2991246	COIL CORD ASM 72"	*72"	1
	2991247	COIL CORD ASM 87"	*87"	1
	2991248	COIL CORD ASM 100"	*100"	1
456	*	STRAIN RELIEF, MOUNT INSTINCT		1
458	2997925	CAM, LATCH, SENSOR w/MAGNET		1
460	2203510	BOLT-SHOULDER, POLYMER, CAM SNSR		1
462	2042711	SPRING-TORSION, SS		1
464	2997814	ASSEMBLY, TILT MOTOR, ULTERRA		1
466	2202326	SUPPORT, TILT SHAFT MID		1
468	2373440	SCREW-#4-24 X 1/4 PHCR SS TY B		3
470	2202930	SPACER, TILT LINKS		2
472	2993300	KNUCKLE, TILT 3/4-8 w/MAG		1
474	2204220	LINK-TILT, LEFT		1
476	2204225	LINK-TILT, RIGHT		1
478	2207331	BUSHING, E-PIN ECCENTRIC		1
480	2203410	SCREW-#10-32 X .5"		4
482	2202324	SUPPORT, TLT SHFT END, REAM		1
484	2207341	BUSHING, RFI-0810-10		1
486	2373481	SCREW-#10-32 X 1/2" SEMS PPH SS		3
488	2263452	SCREW-1/4-20 X 3/4 SHCS S/S		2
490	2073410	SCREW-1/4-20 X 1.125 SHCS SS		2

▲ Not shown on Parts Diagram.

\* This part is included in an assembly and cannot be ordered individually.

# PARTS DIAGRAM & PARTS LIST



Item	Part #	Description	Notes	Quantity
492	2203120	NUT-1/4-20 NYLON, RIE COATED		2
494	2204030	CTRL BOARD ASM, MAIN ULTERRA 2		1
496	2373487	SCREW-#8-32 X 3/4" PPH MACH SS		4
498	2205412	SHRINK TUBE.75 ID x 2"		1
500	2202623	PIN,QCK REL. 5/16 x 3 1/2		1
502	2052510	CABLE CLAMP, 3/16", NYLON		8
504	2040721	CLAMP-CABLE 3/8"		2
506	2052511	CABLE CLAMP,1/4" VANTAGE		3
508	2073414	SCREW-#6-32 X .375 PPH SS(N/A)		12
510	2203440	SCREW-#4-40 X 1/4 PPH SS		4
512	2373440	SCREW-#4-24 X 1/4 PHCR SS TY B		2
514	2200625	LEADWIRE ASM,8AWG,ULT 2 (DPLX)		1
516	2202919	STRAIN RELIEF, POWER		1
518	2323405	SCREW-1/4-20 X 1/2" MCH SS		2
520	830-123	SCREW-M4 X .7X8MM HEX DBL SEMS		4
522	2294610	SEAL, PCBA TERMINAL GRAY .215		2
524	2294611	SEAL, PCBA TERMINAL BLACK .270		2
526	2203930	RAMP-MOTOR, RIGHT		1
528	2203935	RAMP-MOTOR, LEFT		1
530	2997907	RAMP/ACTUATOR ASM w/MAGNET		1
532	2263453	SCREW-1/4-20 X 1" SHCS S/S		4
534	2202708	SPRING-TORSION,RGT HND WIND,SS		1
536	2372100	SCREW-#8-18 X 5/8 THD* (SS		1
538	2201723	WASHER-#6, .625 OD, SS		1
540	2203921	SIDEPLATE, RIGHT, WHITE	*SALTWATER WHITE*	1
	2203920	SIDEPLATE, RIGHT, BLACK	*SALTWATER BLACK*	1
542	2203926	SIDEPLATE, LEFT, WHITE	*SALTWATER WHITE*	1
	2203925	SIDEPLATE, LEFT, BLACK	*SALTWATER BLACK*	1
544	2323405	SCREW-1/4-20 X 1/2" MCH SS		8
546	2205558	DECAL, SIDEPLATE RIGHT SW		1
548	2205559	DECAL, SIDEPLATE LEFT SW		1
550	2206516	HOUSING-CONTROL, WHITE	*SALTWATER WHITE*	1
	232344	HOUSING-CONTROL, BLACK	*SALTWATER BLACK*	1
552	2205611	DECAL-PWR SWITCH, SW, WHT	*SALTWATER WHITE*	1
	2205612	DECAL-PWR SWITCH, SW, BLK	*SALTWATER BLACK*	1
554	2207311	BUSHING, STEER HOUSING PIVOT		2
556	2202650	SHAFT, SUPPORT, TILT		1
558	2373013	E-RING, EXTERNAL SS .625, HNDL		2

▲ Not shown on Parts Diagram.

✘ This part is included in an assembly and cannot be ordered individually.



# PARTS DIAGRAM & PARTS LIST



Item	Part #	Description	Notes	Quantity
560	2383122	NUT 3/8-16 NYLON INST LOCKNUT		6
562	2378608	ANTI-SEIZE TUBE 4CC, TALON		1
564	2321710	WASHER, RUBBER MOUNT		6
566	2323440	SCREW-3/8-16X 2 1/2 HHCS SS		6
568	2371796	BACKUP BAR 3/16 X 1 X 2		6
570	2206576	RACK, BELT, TAPER, ANODIZED		1

▲ Not shown on Parts Diagram.

✘ This part is included in an assembly and cannot be ordered individually.



# NOTES



A large area containing multiple horizontal lines for writing notes.

# RECOMMENDED ACCESSORIES

## › ON-BOARD & PORTABLE BATTERY CHARGERS

Stop buying new batteries and start taking care of the ones you've got. Many chargers can actually damage your battery over time – creating shorter run times and shorter overall life. Digitally controlled Minn Kota chargers are designed to provide the fastest charge that protect and extend battery life.



MK212PCL



MK210D



MK110PD

## › TALON SHALLOW WATER ANCHOR

Talon is the only shallow water anchor with up to 15' of anchoring depth, multiple anchoring modes, and control from the bow, transom, console, remote or mobile device.



### BUILT-IN WORK LIGHT

Lets you tie lines and work from the transom any time of day — or night. Includes both white and blue LED lights with three brightness settings.



### UP TO 15' DEEP

Control more water and catch more fish with the first 15' shallow water anchor.



### BLUETOOTH® CONNECTIVITY

Lets you control Talon from your mobile device and easily update it. Also opens up communication to other control options.



### MORE CONTROL OPTIONS

- Control Panel
- Wireless Remote
- Mobile App
- Wireless Foot Switch
- Humminbird® Connectivity
- Advanced GPS Navigation System Remote



## › MINN KOTA ACCESSORIES

We offer a wide variety of trolling motor accessories, including:

- 60-Amp Circuit Breaker
- Mounting Brackets
- Stabilizer Kits
- Boat Deck Reinforcement Kit
- Battery Connectors
- Battery Boxes
- Quick Connect Plugs



minnkota.johnsonoutdoors.com    

Part #2207127

Minn Kota Consumer & Technical Service  
Johnson Outdoors Marine Electronics, Inc.  
PO Box 8129  
Mankato, MN 56001

ECN 44313

121 Power Drive  
Mankato, MN 56001  
Phone (800) 227-6433  
Fax (800) 527-4464



©2023 Johnson Outdoors Marine Electronics, Inc.  
All rights reserved.

Rev A

10/23