

GARMIN®

FORCE® KRAKEN TROLLING MOTOR

Owner's Manual

© 2023 Garmin Ltd. or its subsidiaries

All rights reserved. Under the copyright laws, this manual may not be copied, in whole or in part, without the written consent of Garmin. Garmin reserves the right to change or improve its products and to make changes in the content of this manual without obligation to notify any person or organization of such changes or improvements. Go to www.garmin.com for current updates and supplemental information concerning the use of this product.

Garmin®, the Garmin logo, ActiveCaptain®, and Force® are trademarks of Garmin Ltd. or its subsidiaries, registered in the USA and other countries. These trademarks may not be used without the express permission of Garmin.

Wi-Fi® is a registered mark of Wi-Fi Alliance Corporation.

MN: A04109 / B04109 / C04109

拖釣推進器

Table of Contents

Getting Started	1	Editing a Waypoint Name.....	18
Adjusting the Depth of the Trolling Motor.....	1	Deleting a Waypoint.....	18
Deploying the Motor from the Stowed Position.....	2	Routes.....	18
Stowing the Motor from the Deployed Position.....	3	Navigating a Route.....	18
Trolling Motor Display Panel.....	4	Viewing Route Details.....	18
Status Indicator.....	5	Editing a Route Name.....	19
Calibrating the Trolling Motor.....	6	Deleting a Route.....	19
Setting the Bow Offset.....	6	Tracks.....	19
Connecting to a Chartplotter.....	7	Saving the Active Track.....	19
Remote Control	7	Clearing the Active Track.....	19
Installing Batteries.....	7	Navigating to the Start of the Active Track.....	19
Attaching a Lanyard.....	8	Navigating a Saved Track.....	20
Remote Control Buttons.....	8	Viewing Saved Track Details.....	20
Remote Control Screen.....	10	Editing a Saved Track Name.....	20
Navigating the Menu.....	10	Deleting a Saved Track.....	20
Calibrating the Remote Control.....	11	Navigating.....	20
Pairing the Remote Control.....	11	Pausing and Resuming Navigation..	21
Pairing an Additional Remote Control.....	11	Stopping Navigation.....	21
Foot Pedal	12	Settings	21
Installing Batteries.....	13	Trolling Motor Settings.....	21
Pairing the Foot Pedal.....	13	Wireless Network Settings.....	22
Status Indicator.....	13	Remote Control Settings.....	22
Disabling the Heading Hold Function on the Foot Pedal.....	14	Backlight Settings.....	22
Operation	14	Maintenance Needs and Schedule..	23
Turning the Propeller On and Off.....	14	Motor Information	23
Adjusting the Speed of the Motor....	14	Getting Started with the ActiveCaptain App.....	23
Maintaining Your Speed.....	15	Updating Software with the ActiveCaptain App.....	24
Steering.....	15	Stowed Dimensions.....	25
Steering the Trolling Motor Manually.....	15	Deployed Dimensions.....	25
Maintaining Your Heading.....	15	Registering Your Device.....	26
Holding Your Position.....	16	Contacting Garmin Support.....	26
Gesture Controls.....	17	Specifications	27
Waypoints.....	17	Trolling Motor.....	27
Creating a Waypoint.....	17	Motor Thrust and Current-Draw Information.....	28
Navigating to a Waypoint.....	17	Remote Control.....	29
Viewing Waypoint Details.....	18	Foot Pedal.....	29

Getting Started

⚠ WARNING

See the *Important Safety and Product Information* guide in the product box for product warnings and other important information.

Do not run the motor when the propeller is out of the water. Contact with the rotating propeller may result in severe injury.

Do not use the motor in areas where you or other people in the water may come into contact with the rotating propeller.



You are responsible for the safe and prudent operation of your vessel. The autopilot features on the trolling motor are tools that enhance your capability to operate your boat. They do not relieve you of the responsibility of safely operating your boat. Avoid navigational hazards and never leave the motor controls unattended.

Learn to operate the autopilot features on calm and hazard-free open water.

Use caution when operating the trolling motor near hazards in the water, such as trees, shallow rocks, docks, pilings, and other boats.

Always disconnect the motor from the battery before handling or working with the propeller, propeller drive motor, electrical connections, or electronics enclosures to avoid serious injury or property damage.

⚠ CAUTION

Always keep the remote control on your person when using the trolling motor. If the operation of the trolling motor needs to be changed or stopped at any time, you can press  on the remote control, press on the foot pedal, or press  on the mount to stop the propeller.

When using the autopilot features, be prepared for sudden stops, acceleration, and turns.

When stowing or deploying the motor, be aware of the risk of entrapment or pinching from moving parts, which can result in injury.

When stowing or deploying the motor, be aware of slick surfaces around the motor. Slipping when stowing or deploying the motor may result in injury.

Adjusting the Depth of the Trolling Motor

- 1 Stow the motor.
- 2 Loosen the collar on the motor shaft.

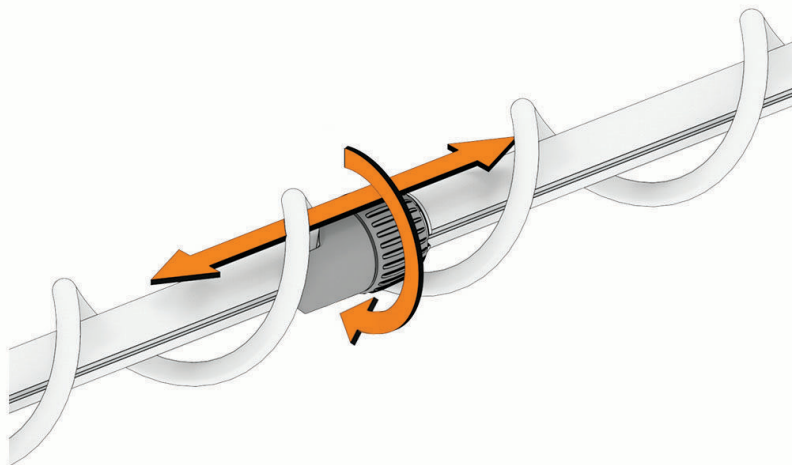

- 3 Slide the collar to raise or lower the depth of the trolling motor.
- 4 Tighten the collar.
- 5 Deploy the motor to check the depth.
- 6 Repeat this procedure if necessary to set the correct depth.

Deploying the Motor from the Stowed Position

- 1 Slide the depth adjustment collar away from the motor housing.
- 2 Hold down the pedal to release the latch ①.

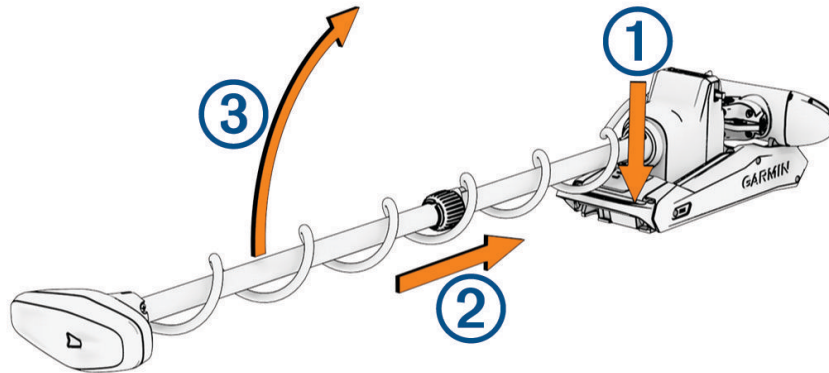

- 3 Slide the motor out ②, release the pedal, and raise the motor slowly ③ into the deployed position.
- 4 If necessary, push the shaft away to lock the motor in the deployed position.

NOTICE

The depth adjustment mechanism is keyed to align with the steering motor, and they should align automatically when you deploy the motor. To avoid unexpected steering performance, check for obstructions that may prevent the parts from aligning correctly before using the motor.

Stowing the Motor from the Deployed Position

- 1 Hold down the pedal to release the latch ①.

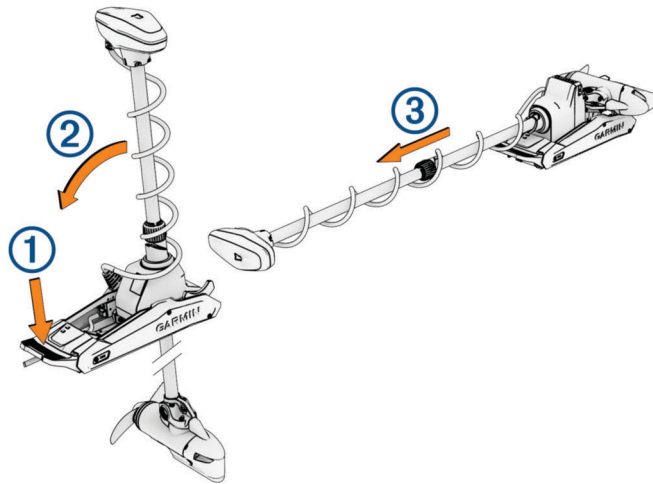

NOTE: The motor should automatically steer to 90° for stowing. The propeller stow side can be configured in the settings menu.

- 2 Tilt the shaft back ②, and then raise the motor slowly while tilting the shaft to the horizontal position.
- 3 Slide the motor into the motor catch until it locks in the stowed position ③.

⚠ WARNING

Push forward along the length of the shaft, and then pull backward along the length of the shaft to ensure that the motor is firmly locked in place. If the motor is not firmly locked in the stowed position, the motor may deploy unexpectedly while in rough waters or trailering, which could result in possible property damage or serious personal injury.

The depth adjustment collar should be moved as close to the base of the motor as possible. Failure to do so could cause unexpected trolling motor deployment, leading to potential property damage or serious personal injury.









- 4 If installed, clamp the motor shaft in the stabilizer.

Trolling Motor Display Panel

The display panel on the trolling motor mount shows important information at a glance.

NOTE: The backlight on the display panel reacts to the ambient light, and dims automatically at night.



 Speed	Shows the motor speed level (Adjusting the Speed of the Motor, page 14).
 Trolling motor battery status	Green: the motor battery voltage is good. Yellow: the motor battery voltage is low. Red: the motor battery voltage is very low. Flashing red: the motor battery voltage is critically low. NOTE: This applies only when the motor is connected to a lead acid battery. Voltage levels may not be accurate with lithium batteries.
 GPS signal status	Green: the motor has a good GPS signal. Yellow: the motor has a poor GPS signal. Red: the motor does not have a GPS signal.
 Motor status	Green: the motor is operating normally. Red (solid): the motor software is starting up. Red (blinking): there is a system error. Blue: the motor is in pairing mode. Yellow: the motor is in recovery mode (for software updates and recovery procedures).
 Power	Hold to turn the motor off. NOTE: By default, the trolling motor turns on automatically when it receives power. It is not necessary to push this button to turn it on. This can be changed in the settings (Trolling Motor Settings, page 21). The trolling motor turns off automatically when it is in the stowed position for two hours. When the propeller is turning, press to stop the propeller. Press three times to enter pairing mode.
 Propeller status	Illuminates when the propeller is active (Turning the Propeller On and Off, page 14).
 Heading hold status	Illuminates when heading hold is active (Maintaining Your Heading, page 15).
 Anchor lock status	Illuminates when anchor lock is active (Holding Your Position, page 16). Press to turn on anchor lock. Hold to turn off anchor lock.

Status Indicator

The  LED indicates the motor status.

Green	Normal operation
Red	Solid: system booting Blinking: system error
Blue	Pairing mode
Yellow	Recovery mode (for software updates and recovery procedures)

Calibrating the Trolling Motor

You must calibrate the compass in the trolling motor before you can use the autopilot features. For the best results, you should calibrate the motor on a day with little or no wind on calm water. You can repeat the calibration process if the autopilot features are not performing as expected.





- 1 Drive the boat to an open area of calm water and stop moving.
The boat must be stationary to begin the calibration process.
- 2 Make sure the trolling motor is deployed (*Deploying the Motor from the Stowed Position*, page 2).
- 3 On the remote control, select  > **Settings** > **Trolling Motor** > **Calibrate** > **Compass**.
A message appears on the display while the trolling motor prepares the calibration process, and you should wait until instructed to begin.
- 4 Using a foot pedal, remote control, or outboard motor to steer, follow the on-screen instructions to calibrate the compass.

Setting the Bow Offset

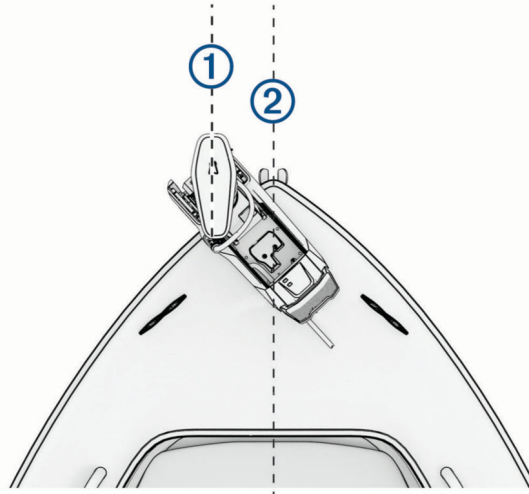
Based on the installation angle, the trolling motor may not align with the center line of your boat. For the best results, you should set the bow offset.

- 1 Using the remote control, adjust the angle of the trolling motor ① so it aligns with the center line of your boat ②, pointing straight forward.





- 2 On the remote control, select  > **Settings** > **Trolling Motor** > **Calibrate** > **Bow Offset**.
- 3 Press  or  to adjust the bow offset.
- 4 Press  to set the bow offset.
- 5 Repeat this procedure if necessary.

Connecting to a Chartplotter

Your compatible Garmin® chartplotter must have the latest software version installed before you can connect the trolling motor.

You can connect the trolling motor wirelessly to a compatible Garmin chartplotter on your boat. After you connect to a compatible chartplotter, you can control the trolling motor from the chartplotter in addition to the remote control and foot pedal.

- 1 Turn on the chartplotter and the trolling motor.
- 2 Make sure that the chartplotter is hosting a wireless network.
NOTE: If you have multiple chartplotters installed, only one is the wireless network host. Consult your chartplotter's owner's manual for more information.
- 3 On the chartplotter, select **Settings > Communications > Wireless Devices > Garmin Trolling Motor > Start**.
- 4 On the trolling motor display panel, press  three times to enter pairing mode.
 on the trolling motor display panel illuminates blue as it searches for a connection to the chartplotter, and changes to green when the connection is successful.
A confirmation message appears on the chartplotter when the connection is successful.
- 5 After the chartplotter and trolling motor connect successfully, enable the trolling motor bar on the chartplotter to control the motor.
See the latest version of your chartplotter's owner's manual for complete operation instructions.

Remote Control

Installing Batteries

The remote control operates using two AA batteries (not included). Use lithium batteries for best results.

- 1 Turn the D-ring counter-clockwise, and pull up to remove the cover.
- 2 Insert two AA batteries, observing polarity.

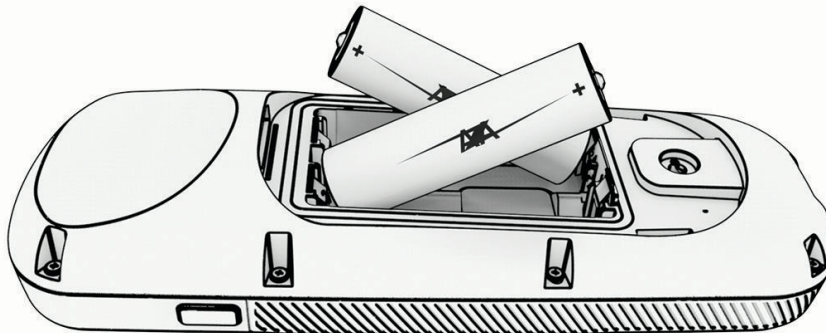

- 3 Replace the battery cover, and turn the D-ring clockwise.

Attaching a Lanyard

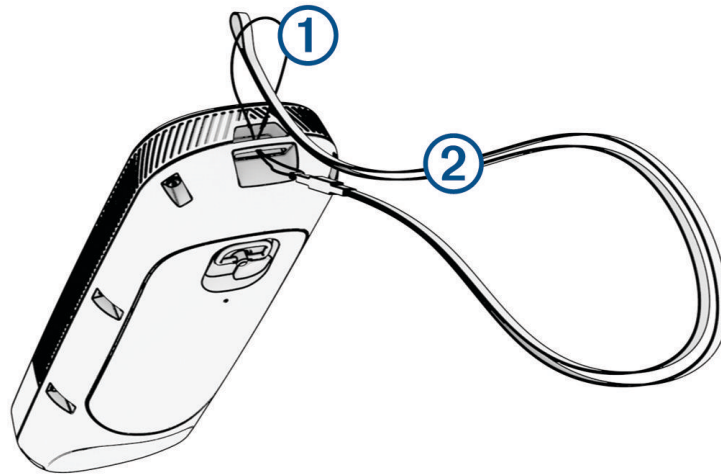

- 1 Starting from the back of the remote control, insert the loop of the lanyard ① through the slot.



- 2 Thread the other end of the lanyard ② through the loop, and pull it tight.
- 3 If necessary, place the lanyard around your neck or wrist to tether it during use.

Remote Control Buttons







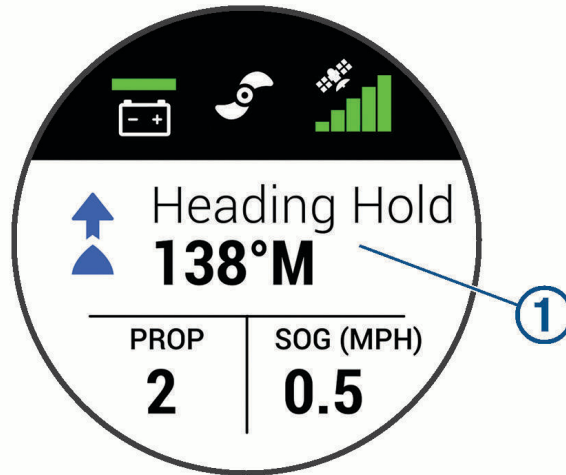

Button	Description
	Hold to turn the remote control on and off.
	Press to turn on and set the cruise control at the current speed over ground (SOG) (Maintaining Your Speed, page 15). Press to disable the cruise control and return to manual speed control.
	If the propeller is on, press to set it to full speed (Toggling Full Speed, page 14). If the propeller is off, press twice to enable the propeller and set it to full speed. Press again to return to the previous speed and propeller state.
	Press for manual control (Steering the Trolling Motor Manually, page 15). Hold to steer using gestures (Using Gesture Controls to Steer, page 17).
	Press to turn the propeller on and off (Turning the Propeller On and Off, page 14).
	Press to navigate the menu (Navigating the Menu, page 10). When in the menu, press  to select a menu item, and press  to go back without saving. When in anchor lock, press to jog the anchor lock position forward, backward, left, or right in 1.5 m (5 ft.) increments. When in heading hold or manual control, press  and  for single-degree step turns, or hold for steering in five-degree increments. Press  and  for incremental speed changes, or hold for continuous speed changes.
	Press to turn on heading hold (set and maintain the current heading) (Maintaining Your Heading, page 15). Press to turn off heading hold, stop the propeller, and resume manual control. Hold to set the heading hold by pointing the remote (Using Gesture Controls to Adjust the Heading Hold, page 17).
	Press to turn on anchor lock. Anchor lock uses the trolling motor to hold your position (Holding Your Position, page 16). When in anchor lock, press to turn off anchor lock and return to the previous steering mode. Hold to jog the anchor lock position by pointing the remote (Using Gesture Controls to Adjust Your Held Position, page 17).
	Press to open the menu. Press to exit the menu.
	Press to mark a waypoint.
1 through 4	Press to open the shortcut for the Garmin chartplotter assigned to the button. ¹

¹ Requires a connection to a compatible Garmin chartplotter. See your chartplotter owner's manual for instructions.







Remote Control Screen



	<p>Shows the operational status of the trolling motor. For example, when in manual control, Manual is shown, and when the heading hold is on, Heading Hold is shown, along with the heading-hold set point in degrees.</p>
	<p>Shows the trolling motor battery status. Green: the motor battery voltage is good. Yellow: the motor battery voltage is low. Red: the motor battery voltage is critically low. TIP: You can change the appearance of the trolling motor battery status so that it shows a numeric value instead of an icon (Trolling Motor Settings, page 21). You can view the remote control battery level by pressing .</p>
	<p>Shows the status of the propeller. When the propeller icon is shown, the propeller is active. When the propeller icon is not shown, the propeller is off.</p>
	<p>Shows the GPS signal strength of the trolling motor.</p>
<p>PROP</p>	<p>Shows the speed level of the propeller (Adjusting the Speed of the Motor, page 14). NOTE: When using the cruise control feature, this field is replaced with .</p>
<p>SOG</p>	<p>Shows the measured speed over ground (SOG) in the specified units.</p>

Navigating the Menu

You can use the menu and arrow keys to navigate the menu on the remote control.

- To open the menu, press .
- To move between different menu items, press  and .
- To select a menu item, press .
- To move back to a previous menu item, press .
- To exit the menu, press  or press  repeatedly until you reach the main screen.

Calibrating the Remote Control

NOTICE





Calibrate the electronic compass outdoors. To improve heading accuracy, do not stand near objects that influence magnetic fields, such as vehicles, buildings, and overhead power lines.

You must calibrate the compass in the remote control before you can control the motor using gestures. If the gesture controls are not working properly after calibration, you can repeat this process as often as needed.

- 1 Select  > **Settings** > **Remote Control** > **Calibrate**.
- 2 Select **Start**, and follow the on-screen instructions.



Pairing the Remote Control

The remote control is paired with the trolling motor at the factory, but you may need to pair them again if the connection is broken.

- 1 Turn on the trolling motor.
- 2 On the trolling motor display panel, press  three times to enter pairing mode.
 on the trolling motor display panel illuminates blue as it searches for a connection.
- 3 Bring the remote control within 1 m (3 ft.) of the display panel on the trolling motor.
- 4 Turn on the remote control.
- 5 On the remote control, select  > **Settings** > **Remote Control** > **Pairing** > **Start**.
 on the trolling motor display panel illuminates green when the connection is successful.

Pairing an Additional Remote Control



NOTE: A maximum of two remote controls can be used with one trolling motor. This is in addition to the foot pedal, chartplotters, and a wearable.

- 1 Turn on the trolling motor.
- 2 On an already paired remote control, select  > **Settings** > **Remote Control** > **Add Additional Remote**.
The trolling motor display panel illuminates blue when the it is ready to pair.
- 3 Bring the additional remote control within 1 m (3 ft.) of the display panel on the trolling motor.
- 4 Turn on the additional remote control.
- 5 On the additional remote control, select  > **Settings** > **Remote Control** > **Pairing** > **Start**.
 on the trolling motor display panel illuminates green when the connection is successful. Device Found is shown on the original remote control, and Connected is shown on the additional remote control.

Foot Pedal

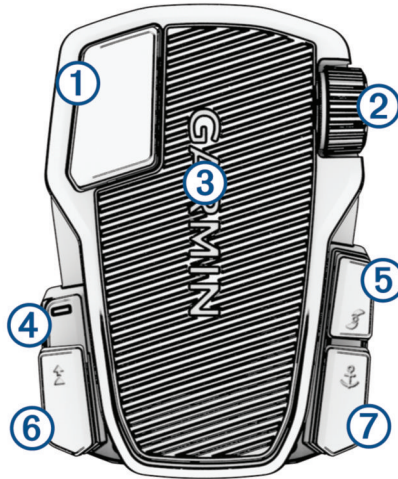
NOTE: The foot pedal is an optional accessory that is sold separately. You can use the foot pedal to operate the trolling motor.



①	Momentary propeller control	Hold to turn on the propeller at the set speed. Release to turn off the propeller.
②	Speed wheel	Rotate the wheel away from you to increase the propeller speed or cruise control speed. Rotate the wheel toward you to decrease the propeller speed or cruise control speed. NOTE: The speed wheel is inactive when anchor lock is on.
③	Steering pedal	Push the pedal with your toes to turn the motor clockwise. Push the pedal with your heel to turn the motor counter-clockwise. NOTE: When anchor lock or heading hold is on, or you are following a route, tilt the pedal or press a button to resume manual control at the previous propeller speed.
④	Status LED	Shows the status of the foot pedal (<i>Status Indicator</i> , page 13).
⑤	 Continuous propeller control	Press to turn the propeller on and off (<i>Turning the Propeller On and Off</i> , page 14).
⑥	 Heading hold	Press to set and maintain the current heading (<i>Maintaining Your Heading</i> , page 15). Press to turn off heading hold, stop the propeller, and resume manual control. TIP: You can disable this function by pressing the heading hold button 6 times in quick succession.
⑦	 Anchor lock	Press to turn on anchor lock. Anchor lock uses the trolling motor to hold your position (<i>Holding Your Position</i> , page 16). Press to turn off anchor lock and return to the previous steering mode.

Installing Batteries



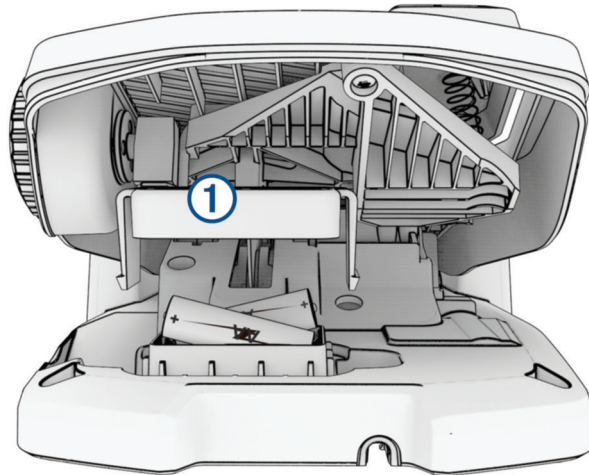

The foot pedal can operate using two AA alkaline, NiMH, or lithium batteries (not included). Use lithium batteries for best results.

- 1 Lift up the front of the foot pedal as far as possible.
- 2 Pinch the sides of the battery cover ①, and pull up to remove it.



- 3 Insert two AA batteries, observing polarity.
- 4 Place the battery cover over the batteries, and push down until both sides snap into place.

Pairing the Foot Pedal

- 1 Turn on the trolling motor.
- 2 On the trolling motor display panel, press  three times to enter pairing mode.
 on the trolling motor display panel illuminates blue as it searches for a connection.
- 3 Bring the foot pedal within 1 m (3 ft.) of the display panel on the trolling motor.
- 4 Connect the foot pedal to power using the power cable, or insert batteries to turn it on.
- 5 Within 30 seconds of turning on the foot pedal, hold  until the status LED on the foot pedal illuminates blue.
- 6 Release .

The status LED on the foot pedal illuminates blue as it searches for a connection, then turns off when it pairs successfully with the trolling motor.

 on the trolling motor display panel changes to green when the connection is successful.

Status Indicator

The LED on the foot pedal indicates the foot pedal status.

Illuminates green	The foot pedal is powering on.
Illuminates and flashes blue	The foot pedal is pairing. The LED turns off when it connects to the trolling motor or the pairing process times out without connecting.
Flashes green when pushing a button	The foot pedal is connected to the trolling motor and sending a command for the button being pushed.
Flashes red when pushing a button	The foot pedal is not connected to the trolling motor.
Off	The LED turns off when the pedal is connected to the trolling motor and not sending commands. This prolongs battery life.

Disabling the Heading Hold Function on the Foot Pedal

You can disable the heading hold function on the foot pedal to avoid accidentally engaging it.

- 1 Make sure that the foot pedal has power.
- 2 On the foot pedal, quickly press  6 times.

The status LED turns red for 1 second to indicate that the heading hold function is disabled on the foot pedal.

TIP: To enable heading hold again, quickly press  6 times. The status LED turns green for 1 second to indicate that the heading hold function is enabled on the foot pedal.

Operation

You can use the remote control, the foot pedal, a compatible Garmin chartplotter, a compatible Garmin wearable, such as a Garmin quatix® 7, or a combination of these devices to operate the trolling motor.

NOTE: The foot pedal is an optional accessory that is sold separately.

In general, most of the instructions provided for the remote control also apply to a connected chartplotter. For specific chartplotter instructions, see the latest owner's manual for your chartplotter.

NOTE: Some features available when using the remote control and chartplotter are not available when using the foot pedal only.

Turning the Propeller On and Off



WARNING

Do not use the motor in areas where you or other people in the water may come into contact with the rotating propeller.

Do not run the motor when the propeller is out of the water. Contact with the rotating propeller may result in severe injury.

- 1 If necessary, deploy the trolling motor (*Deploying the Motor from the Stowed Position, page 2*).



NOTE: The propeller cannot turn on when the trolling motor is in the stowed position.

- 2 On the remote control or foot pedal, press  to turn on the propeller.
- 3 Press  to turn off the propeller.

Adjusting the Speed of the Motor

You can adjust the speed of the trolling motor using the remote control or the foot pedal.

- 1 If necessary, press  on the remote control, or steer with the foot pedal, to enter manual mode.
- 2 Select an option:

- On the remote control, press  and  to increase and decrease the speed of the motor.
- On the foot pedal, rotate the speed wheel away from you and toward you to increase and decrease the speed of the motor.

The PROP field on the remote control and the bars on the display panel indicate the propeller speed (*Trolling Motor Display Panel, page 4*).

- 3 If necessary, turn on the propeller (*Turning the Propeller On and Off, page 14*).

The propeller speed you selected is retained if the propeller is turned off or if you start another function of the motor such as cruise control or anchor lock.

Toggling Full Speed

- 1 On the remote control, press  twice.

The trolling motor propeller speed quickly increases to full speed.

- 2 Press  to return to the previous propeller speed.

TIP: When at full speed, you can press  on the remote control to slowly decrease the propeller speed.

Maintaining Your Speed

Before you can use the cruise control feature, you must calibrate the trolling motor ([Calibrating the Trolling Motor, page 6](#)).

The cruise control feature is an autopilot function that sets and maintains a specific speed over ground, adjusting for changes in current and wind automatically.

NOTE: You can enable the cruise control feature from the remote control only, but can control the speed and direction from both the remote control and foot pedal.

- 1 On the remote control, press .
Cruise control is enabled at the present speed.
- 2 Using the remote control or foot pedal, adjust the speed as needed.
- 3 Using the remote control or foot pedal, adjust the heading as needed.

TIP: You can use cruise control to set the speed while using the heading hold feature ([Maintaining Your Heading, page 15](#)) or following a route ([Navigating a Route, page 18](#)).

To disable cruise control and turn off the propeller, you must press .

Steering

Steering the Trolling Motor Manually

Manual mode is the default operational mode of the trolling motor. In manual mode, you can adjust the direction and speed of the trolling motor as needed.

NOTE: The trolling motor is in manual mode by default when you turn it on.

- 1 If necessary, on the remote control, select .

- 2 Select an action:

- Using the remote control, press  and  to steer.

NOTE: You can also use gesture controls to steer the boat manually using the remote control ([Using Gesture Controls to Steer, page 17](#)).



- Using the foot pedal, push the pedal with your toes and heel to steer.

Maintaining Your Heading

Before you can use the heading hold feature, you must calibrate the trolling motor ([Calibrating the Trolling Motor, page 6](#)).

The heading hold feature is an autopilot function that sets and maintains the current heading of the boat. You can set the behavior of the heading hold feature when accounting for drift ([Changing the Heading Hold Behavior, page 16](#)).

- 1 Steer the boat in the direction you want to go.
- 2 On the remote control or foot pedal, select .

NOTE: You can adjust the direction of the heading hold by pressing  and , or by using gesture controls ([Using Gesture Controls to Adjust the Heading Hold, page 17](#)).

To disable heading hold and return to manual mode, you must select  , or step on the foot pedal.

Changing the Heading Hold Behavior

You can change the how heading-hold feature maintains the heading of your boat when it is affected by the wind or the current.

- 1 On the remote control, select  > **Settings** > **Trolling Motor** > **Heading Hold**.
- 2 Select an option:
 - To keep the boat pointing in the same direction regardless of drift, select **Vessel Align**.

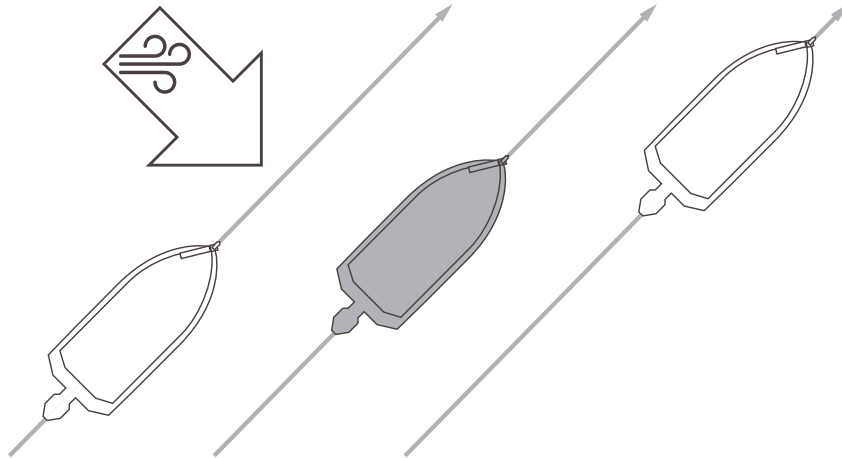

- To keep the boat pointing in the same direction while accounting for drift, select **Go To**.

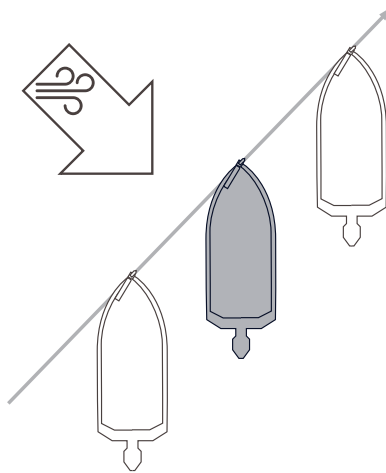

Holding Your Position

Before you can use the anchor lock feature, you must calibrate the trolling motor ([Calibrating the Trolling Motor, page 6](#)).

The anchor lock feature is an autopilot function that uses GPS to set and maintain your position using the trolling motor, acting as if you deployed a physical anchor.

- 1 If necessary, drive the boat to a location you want to set the anchor lock.
- 2 On the remote control or foot pedal, select .

NOTE: You can adjust the anchor lock position 1.5 m (5 ft.) by pressing an arrow key on the remote control, or by using gesture controls ([Using Gesture Controls to Adjust Your Held Position, page 17](#)).



To disable anchor lock, you can press  again, or steer with the foot pedal.

Gesture Controls

You can point or move the remote control to interact with the trolling motor. You must calibrate the compass in the trolling motor ([Calibrating the Trolling Motor, page 6](#)), and the compass in the remote control ([Calibrating the Remote Control, page 11](#)) before you can use gesture controls.



Using Gesture Controls to Steer

You can steer the motor by pointing the remote control.

- 1 If necessary, turn on the propeller ([Turning the Propeller On and Off, page 14](#)).
- 2 Hold .
- 3 While holding , point the remote control to the left or right to steer port or starboard.
- 4 Release  to stop steering.



Using Gesture Controls to Adjust the Heading Hold

You can move the remote control to adjust your heading hold ([Maintaining Your Heading, page 15](#)).

- 1 If necessary, turn on the propeller ([Turning the Propeller On and Off, page 14](#)).
- 2 Hold .
- 3 Point the remote control toward where you want to adjust the heading.
- 4 Release  to set the heading direction.

Using Gesture Controls to Adjust Your Held Position

You can move the remote control to adjust your position when using the anchor lock feature ([Holding Your Position, page 16](#)).

- 1 Hold .
- 2 Point the remote control in the direction you want to move your position.
Your position jogs 1.5 m (5 ft.) in the direction you point.
- 3 Release .
- 4 Repeat this procedure until the you are in the position you want.

Waypoints

Waypoints are used to mark locations so you can return to them later.

When you connect the trolling motor to a chartplotter, the waypoints stored on the chartplotter are synchronized with the waypoints stored on the trolling motor. Adding, deleting, or editing waypoints on a chartplotter automatically changes the waypoints stored on the trolling motor. Adding or editing waypoints on the trolling motor changes the waypoints stored on the chartplotter.

NOTE: Deleting waypoints, restoring default settings, or clearing user data from the remote does not affect the waypoints on the chartplotter.

You can save up to 5000 waypoints.

Creating a Waypoint

You can save your current location as a waypoint.

- 1 If necessary, drive to a location you want to save as a waypoint.
- 2 On the remote control, press .

Navigating to a Waypoint

- 1 On the remote control, select  > **Waypoints**.
A list of the ten closest waypoints is shown.
- 2 Select a waypoint.
- 3 Select **Navigate To**.
- 4 Turn on the propeller ([Turning the Propeller On and Off, page 14](#)).
The trolling motor drives to the waypoint location ([Navigating, page 20](#)).

Viewing Waypoint Details

- 1 On the remote control, select  > **Waypoints**.
A list of the ten closest waypoints is shown.
- 2 Select a waypoint.
- 3 Select **Review**.

Editing a Waypoint Name

- 1 On the remote control, select  > **Waypoints**.
A list of the ten closest waypoints is shown.
- 2 Select a waypoint.
- 3 Select **Edit**.
- 4 Enter a new name for the waypoint.

Deleting a Waypoint

- 1 On the remote control, select  > **Waypoints**.
A list of the ten closest waypoints is shown.
- 2 Select a waypoint.
- 3 Select **Delete**.

Routes

A route is a sequence of locations that leads you to your final destination.

When you connect the trolling motor to a chartplotter, the routes stored on the chartplotter are synchronized with the routes stored on the trolling motor. Deleting or editing routes on one device automatically changes the routes stored on the other device. You can create routes on the chartplotter only.

You can save up to 100 routes.

Navigating a Route

- 1 On the remote control, select  > **Routes**.
A list of the ten closest routes is shown.
- 2 Select a route.
- 3 Select **Navigate To**.
- 4 Select an option:
 - To navigate the route from the starting point used when the route was created, select **Forward**.
 - To navigate the route from the destination point used when the route was created, select **Backward**.
 - To navigate from your current location to the beginning of the route, then navigate the route, select **From Start**.
- 5 Turn on the propeller (*Turning the Propeller On and Off*, page 14).
The trolling motor drives along the route in the chosen direction (*Navigating*, page 20).

As you approach the end of the route, by default, the trolling motor switches to the anchor lock feature and holds position at the end of the route. You can change this behavior in the settings (*Trolling Motor Settings*, page 21).

Viewing Route Details

- 1 On the remote control, select  > **Routes**.
A list of the ten closest routes is shown.
- 2 Select a route.
- 3 Select **Review**.

Editing a Route Name

- 1 On the remote control, select  > **Routes**.
A list of the ten closest routes is shown.
- 2 Select a route.
- 3 Select **Edit**.
- 4 Enter a new name for the route.

Deleting a Route

- 1 On the remote control, select  > **Routes**.
A list of the ten closest routes is shown.
- 2 Select a route.
- 3 Select **Delete**.

Tracks

A track is a recording of the path of your boat. The track currently being recorded is called the active track, and it can be saved. You can save up to 50 tracks.

When you connect the trolling motor to a chartplotter, the active track and saved tracks stored on the chartplotter are synchronized with the active track and saved tracks stored on the trolling motor. Adding, deleting, or editing active and saved tracks on one device automatically changes the active and saved tracks stored on the other device.

Saving the Active Track

The track currently being recorded is called the active track. You can save the active track and navigate it later. You can save up to 50 tracks on the trolling motor.

- 1 On the remote control, select  > **Tracks** > **Save Active Track**.
The active track is saved with the current date as the track name.
- 2 Change the name for the saved track (optional).

Clearing the Active Track

Select  > **Tracks** > **Clear Active Track**.

The track memory is cleared, and the active track continues to be recorded.

Navigating to the Start of the Active Track

The track currently being recorded is called the active track. You can navigate from your current position back to the starting point of the active track along the path you traveled.

- 1 Select  > **Tracks** > **Backtrack**.
- 2 Turn on the propeller (*Turning the Propeller On and Off, page 14*).
The trolling motor navigates back to the starting point of the active track along the path you traveled (*Navigating, page 20*).

Navigating a Saved Track

- 1 Select  > **Tracks** > **Saved Tracks**.

A list of the ten closest saved tracks is shown.

- 2 Select a saved track.
- 3 Select **Navigate To**.
- 4 Select an option:
 - To navigate the saved track from the beginning of the track to the end, select **Forward**.
 - To navigate the saved track from the end of the track back to the beginning, select **Backward**.
- 5 Turn on the propeller (*Turning the Propeller On and Off, page 14*).
The trolling motor drives along the saved track in the chosen direction (*Navigating, page 20*).

Viewing Saved Track Details

- 1 On the remote control, select  > **Tracks** > **Saved Tracks**.

A list of the ten closest saved tracks is shown.

- 2 Select a saved track.
- 3 Select **Review**.

Editing a Saved Track Name

- 1 On the remote control, select  > **Tracks** > **Saved Tracks**.

A list of the ten closest saved tracks is shown.

- 2 Select a saved track.
- 3 Select **Edit**.
- 4 Enter a new name for the saved track.

Deleting a Saved Track

- 1 On the remote control, select  > **Tracks** > **Saved Tracks**.

A list of the ten closest saved tracks is shown.

- 2 Select a saved track.
- 3 Select **Delete**.

Navigating

Before you can navigate, you must calibrate the trolling motor (*Calibrating the Trolling Motor, page 6*).

The trolling motor uses GPS to steer the boat to a waypoint location or to follow a route or a track.

- 1 On the remote control, select an option:
 - Begin navigating to a saved waypoint (*Navigating to a Waypoint, page 17*).
 - Begin navigating a saved route (*Navigating a Route, page 18*).
 - Begin retracing the active track (*Navigating to the Start of the Active Track, page 19*).
 - Begin navigating a saved track (*Navigating a Saved Track, page 20*).



NOTE: You can also use the trolling motor to follow autoguidance paths when navigation is started from a connected chartplotter. See your chartplotter owner's manual for more information.

Navigating is shown on the remote control screen, and the trolling motor automatically steers the boat to the destination.

- 2 Adjust the speed as needed.

Pausing and Resuming Navigation

1 While navigating, on the remote control, select an option:

- To pause navigation while continuing in the same direction at the same speed, select  > **Standby**.
- To pause navigation and set anchor lock, select 

Navigation stops, and the trolling motor returns to manual mode or maintains your position in anchor lock.

2 Select  > **Follow Route** or press  to resume navigation.

3 If necessary, start the propeller.

Stopping Navigation

Select  > **Stop Nav**.

Navigation stops, and the trolling motor returns to manual mode.

Settings

Trolling Motor Settings

On the remote control, select  > **Settings** > **Trolling Motor**.

Wi-Fi: Sets the wireless network preferences for the trolling motor (*Wireless Network Settings, page 22*).

Calibrate: Calibrates the trolling motor compass (*Calibrating the Trolling Motor, page 6*) and sets the trolling motor bow offset (*Setting the Bow Offset, page 6*).

Units: Sets the units of measure.

Battery: Changes the appearance of the trolling motor battery indicator from an icon to a numeric value.

Prop Stow Side: Sets which side of the trolling motor the propeller rotates to when stowing the trolling motor. This is helpful when you store other items near the stowed propeller. This may also be necessary if you install a LiveScope™ transducer on the trolling motor.

Auto Power On: Turns on the trolling motor when you apply power to the system.

Heading Hold: Sets the behavior of the heading hold feature (*Changing the Heading Hold Behavior, page 16*).

Nav. Arrival: Sets the behavior of the trolling motor when you reach the end of a route. With the Anchor Lock setting, the trolling motor holds the position using the anchor lock feature when the boat reaches the end of the route. With the Manual setting, the propeller turns off when the boat reaches the end of the route.

CAUTION

When using Manual for the Nav. Arrival setting, you must be ready to take control of the boat.

Anchor Gain: Sets the response of the trolling motor when in anchor lock mode. If you need the trolling motor to be more responsive and move quicker, increase the value. If the motor is moving too much, decrease the value.

Navigation Gain: Sets the response of the trolling motor when navigating. If you need the trolling motor to be more responsive and move quicker, increase the value. If the motor is moving too much, decrease the value.

Clear User Data: Deletes all saved waypoints, routes, tracks, and your active track.

NOTE: If you are connected to a chartplotter, selecting this clears user data from both the trolling motor and the connected chartplotter.

Restore Defaults: Resets the trolling motor settings to the factory default values.

Wireless Network Settings

On the remote control, select  > **Settings** > **Trolling Motor** > **Wi-Fi**.

NOTE: The active Wi-Fi® mode is shown at the top of the screen.

Mode: Sets the Wi-Fi mode. You can turn off Wi-Fi technology, join the network of a chartplotter, or create a wireless access point to use the ActiveCaptain® app (*Getting Started with the ActiveCaptain App, page 23*).

Setup > Name: Sets the name of the wireless access point on the trolling motor (ActiveCaptain mode only).

Setup > Password: Sets the password for the wireless access point on the trolling motor (ActiveCaptain mode only).

Remote Control Settings

On the remote control, select  > **Settings** > **Remote Control**.

Backlight: Adjusts the backlight settings. (*Backlight Settings, page 22*)

Beeper: Sets the beeper to sound for key presses and alarms.

Auto Power Off: Sets the length of time before the remote control turns off automatically.

Calibrate: Calibrates the remote control for the gesture-control features (*Calibrating the Remote Control, page 11*).

Pairing: Pairs the remote control with the trolling motor (*Pairing the Remote Control, page 11*).

Language: Sets the on-screen text language.

Restore Defaults: Resets the remote control to factory default settings. This restores the default configuration settings on the remote control, but does not remove saved user data.

Backlight Settings

On the remote control, select  > **Settings** > **Remote Control** > **Backlight**.

Keys: Sets the backlight to turn on when a key is pressed.

Alarms: Sets the backlight to turn on when an alarm sounds on the remote control.

Timeout: Sets the length of time before the backlight turns off.

Brightness: Sets the brightness level of the backlight.

Maintenance Needs and Schedule

NOTICE

After using the motor in salt water or brackish water, you must rinse off the entire motor with fresh water, and apply a water-based silicone spray using a soft cloth. You should avoid spraying jets of water at the cap on the top of the shaft when rinsing the motor.

To maintain your warranty, you must perform a series of routine maintenance tasks as you prepare your motor for the season. If you use or transport the motor in salt water or dry, dusty environments (traveling on gravel roads, for example) you should perform these tasks more often during the season.

For detailed procedures and information on service and replacement parts, go to garmin.com/manuals/force_kraken_trolling_motor to download the *Force Kraken Trolling Motor Maintenance Manual*.

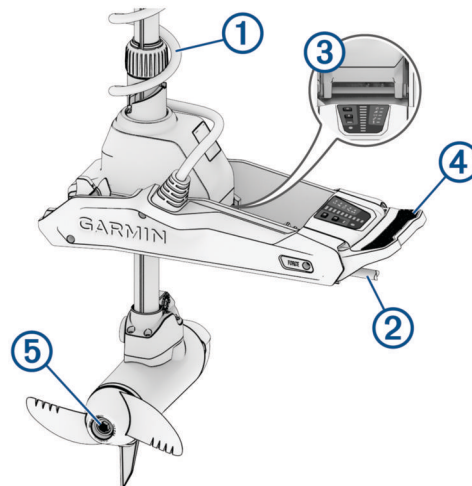

- Examine the coil cable ① for wear, and replace it as necessary.
- Check and clean the power cables ②.
- Lubricate the hinge ③ with marine grade grease.
- Clean and lubricate the stow and deploy latch pedal ④ and latch bar.
- Clean or replace the anodes ⑤ in the propeller drive motor.
- Remove entangled fishing line and other obstructions from the propeller.

Motor Information

Getting Started with the ActiveCaptain App

You can connect a mobile device to the trolling motor using the ActiveCaptain app. The app provides a quick and easy way for you to interact with your trolling motor and update the device software.

- 1 On the remote control, select  > **Settings** > **Trolling Motor** > **Wi-Fi** > **Mode** > **ActiveCaptain** > **Setup**.
- 2 Enter a name and password for this network.
- 3 From the application store on your mobile device, install and open the ActiveCaptain app.
- 4 Bring the mobile device near the trolling motor.
- 5 From your mobile device settings, open the Wi-Fi connections page and connect to the trolling motor, using the name and password you entered in the previous step.

Updating Software with the ActiveCaptain App

Updating the trolling motor software also updates the software in all connected peripherals, such as the foot pedal and remote control.

You can go to garmin.com/videos/trolling_motor_update/ and watch a video to assist with the software-update process.

NOTICE

Software updates may require the app to download large files. Regular data limits or charges from your internet service provider apply. Contact your internet service provider for more information about data limits or charges.

The installation process will take several minutes.

NOTE: To update the trolling motor, you must connect your mobile device directly to a dedicated Wi-Fi network on the trolling motor using the ActiveCaptain app. You cannot update the trolling motor using a chartplotter.

- 1 If necessary, set up the trolling motor for use with the ActiveCaptain app (*Getting Started with the ActiveCaptain App*, page 23).
- 2 Connect the mobile device to the dedicated Wi-Fi network on the trolling motor.
Connecting to the Wi-Fi network on the trolling motor provides the app with the information needed to download the appropriate update files.
- 3 Open the ActiveCaptain app.
- 4 Disconnect the mobile device from the dedicated Wi-Fi network on the trolling motor.
- 5 Connect the mobile device to the internet
- 6 From the ActiveCaptain app, select **My Marine Devices > Download**.
NOTE: The option to download an update is shown only if a software update is available for your device. The ActiveCaptain app downloads the update to the mobile device.
- 7 Reconnect the mobile device to the dedicated Wi-Fi network on the trolling motor.
The update is transferred to the trolling motor. This could take up to 30 minutes to complete.
- 8 After the transfer to the trolling motor is complete, turn off the trolling motor.
- 9 Turn on the trolling motor.
After approximately 30 seconds, the motor speed indicator lights on the trolling motor display panel blink to indicate that the software is updating.
- 10 Make sure the remote control is turned on and connected.
After the trolling motor software update is complete, if an update for the remote control is available, the speed indicator lights blink, and a countdown begins on the remote control. At the end of the countdown, the remote control displays  while it completes the update process. This could take up to 5 minutes to complete.
- 11 Make sure the foot pedal is turned on and connected.
After the trolling motor software update is complete, if an update for the foot pedal is available, the indicator light on the foot pedal illuminates purple while it completes the update process. When the indicator light turns off, the update is complete.

Stowed Dimensions

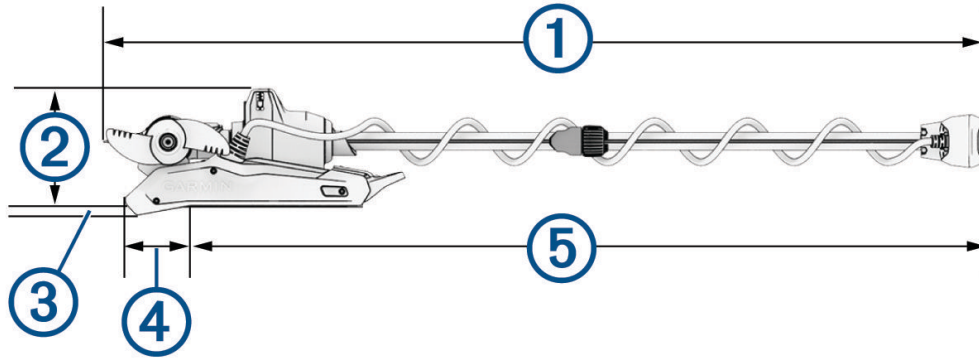

Item	63 in. Model	75 in. Model	90 in. Model
① overall length	194.1 cm (76 ⁷ / ₁₆ in.)	224.8 cm (88 ¹ / ₂ in.)	262.68 cm (103 ³ / ₈ in.)
② mount height	26.2 cm (10 ⁵ / ₁₆ in.)	26.2 cm (10 ⁵ / ₁₆ in.)	26.2 cm (10 ⁵ / ₁₆ in.)
③ overhang height	1.7 cm (1 ¹ / ₁₆ in.)	1.7 cm (1 ¹ / ₁₆ in.)	1.7 cm (1 ¹ / ₁₆ in.)
④ minimum overhang length	20.7 cm (8 ¹ / ₈ in.)	20.7 cm (8 ¹ / ₈ in.)	20.7 cm (8 ¹ / ₈ in.)
⑤ maximum length on boat	168.3 cm (66 ¹ / ₄ in.)	206.4 cm (81 ¹ / ₄ in.)	236.88 cm (93 ¹ / ₄ in.)

Deployed Dimensions

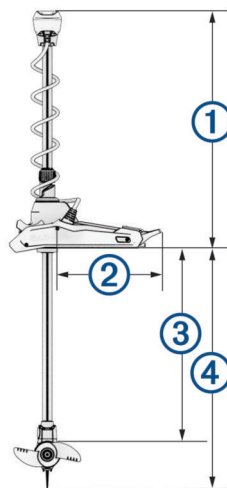

Item	63 in. Model	75 in. Model	90 in. Model
① minimum height	48.6 cm (19 1/8 in.)	48.6 cm (19 1/8 in.)	48.6 cm (19 1/8 in.)
② mount length on deck	46 cm (18 1/8 in.)	46 cm (18 1/8 in.)	46 cm (18 1/8 in.)
③ maximum propeller depth	126 cm (49 5/8 in.)	156.5 cm (61 5/8 in.)	194.6 cm (76 5/8 in.)
④ maximum distance to from mount to skeg tip	145 cm (57 1/4 in.)	175.9 cm (69 1/8 in.)	213.7 cm (84 1/8 in.)

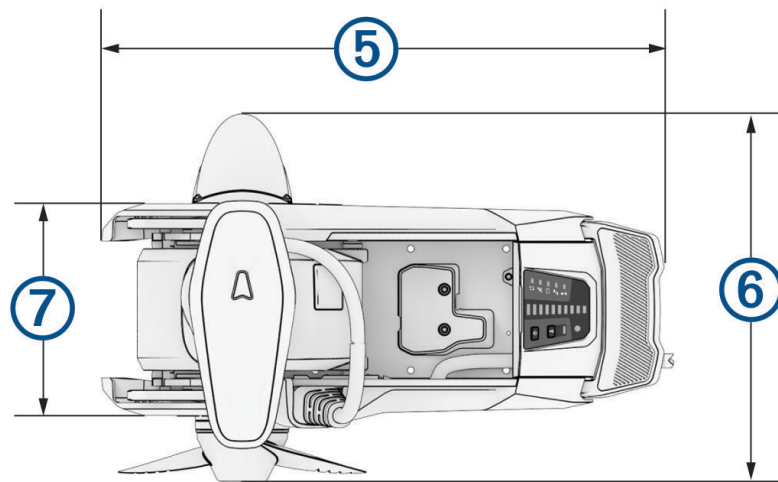

Item	All Models
⑤ mount length	61.2 cm (24 1/8 in.)
⑥ motor head length	With transducer: 42.7 cm (16 13/16 in.) Without transducer: 41.2 cm (16 1/4 in.)
⑦ mount width	24.6 cm (9 11/16 in.)

Registering Your Device

Help us better support you by completing our online registration today.

- Register using the ActiveCaptain app.
- Keep the original sales receipt, or a photocopy, in a safe place.

Contacting Garmin Support

- Go to support.garmin.com for help and information, such as product manuals, frequently asked questions, videos, and customer support.
- In the USA, call 913-397-8200 or 1-800-800-1020.
- In the UK, call 0808 238 0000.
- In Europe, call +44 (0) 870 850 1241.

Specifications

Trolling Motor

Weight (motor, mount, and cables)	63 in. white model: 24 kg (53 lb.) 63 in. black model: 24.5 kg (54 lb.) 75 in. white model: 24.5 kg (54 lb.) 75 in. black model: 25.4 kg (56 lb.) 90 in. white model: 25 kg (55 lb.)
Weight (stabilizer)	0.66 kg (1.45 lb.)
Operating temperature	From -5° to 40°C (from 32° to 104°F)
Storage temperature	From -40° to 85°C (-40° to 185°F)
Material	Mount and motor housing: aluminum Shaft cap, display panel, and side panels: plastic Motor shaft: fiberglass
Water rating	Shaft cap: IEC 60529 IPX5 ² Steering motor housing: IEC 60529 IPX7 ³ Display panel housing: IEC 60529 IPX7 ³ Propeller drive motor housing: IEC 60529 IPX8 ⁴
Compass safe distance	61 cm (2 ft.)
Power cable length	63 in. black model: 0.9 m (3 ft.) 63 in. white model: 1.2 m (4 ft.) 75 in. model: 1.2 m (4 ft.) 90 in. model: 1.2 m (4 ft.)
Input voltage	From 20 to 45 Vdc
Input amperage	60 A continuous
Breaker (not included)	42 VDC or greater, suitable for 60 A continuous NOTE: You can protect the system by using a larger circuit breaker, not to exceed 90 A, if you are operating under high temperatures or if you are sharing the circuit with other devices. You should verify that your boat wiring meets marine wiring standards using a larger breaker before changing it.
Main power usage at 36 Vdc 60 A	Off: 72 mW Full power: 2160 W
Radio frequency	2.4 GHz @ 17.4 dBm Max

² The part withstands projected water exposure from any direction (such as rain).

³ The part withstands incidental immersion in water up to 1 m deep for up to 30 min.

⁴ The part withstands continuous immersion in water up to 3 m deep.

Motor Thrust and Current-Draw Information

You can refer to these tables to understand the relationship between the throttle level, output power, and current consumption of the motor. These values assume you are using an official Garmin high efficiency propeller, in relatively calm water, with the motor deployed deeply enough not to ventilate, and with tolerances of ± 7 N (Newton) (5 lbf (pound-force)) and ± 5 A.

24.0 Vdc Power Source

Throttle Level	Thrust	Current
10%	25 N (6 lbf)	2 A
20%	45 N (10 lbf)	3 A
30%	70 N (16 lbf)	6 A
40%	101 N (23 lbf)	9 A
50%	140 N (31 lbf)	14 A
60%	184 N (41 lbf)	21 A
70%	233 N (52 lbf)	29 A
80%	287 N (65 lbf)	40 A
90%	345 N (78 lbf)	54 A
100%	355 N (80 lbf)	57 A

36.0 Vdc Power Source

Throttle Level	Thrust	Current
10%	21 N (5 lbf)	1 A
20%	41 N (9 lbf)	2 A
30%	69 N (16 lbf)	4 A
40%	103 N (23 lbf)	6 A
50%	144 N (32 lbf)	10 A
60%	191 N (43 lbf)	15 A
70%	246 N (55 lbf)	21 A
80%	307 N (69 lbf)	29 A
90%	375 N (84 lbf)	39 A
100%	445 N (100 lbf)	54 A

Remote Control

Dimensions (W×H×D)	152 x 52 x 32 mm (6 x 2 x 1 ¹ / ₄ in.)
Weight	109 g (3.8 oz.) without batteries
Material	Glass-filled nylon
Display type	Sunlight-visible, transfective memory-in-pixel (MIP)
Display resolution	R240 x 240 pixels
Display size (diameter)	30.2 mm (1 ³ / ₁₆ in.)
Operating temperature	From -15° to 55°C (5° to 131°F)
Storage temperature	From -40° to 85°C (-40° to 185°F)
Battery type	2 AA (not included)
Battery life	240 hr., typical use
Radio frequency	2.4 GHz @ 10.0 dBm nominal
Water rating	IEC 60529 IPX7 ⁵
Compass-safe distance	15 cm (6 in.)

Foot Pedal

Dimensions (L×W×H)	303 × 221 × 110 mm (11 ¹⁵ / ₁₆ × 8 ¹¹ / ₁₆ × 4 ⁵ / ₁₆ in.)
Weight	1.8 kg (4 lb)
Operating temperature	From -15° to 55°C (5° to 131°F)
Storage temperature	From -40° to 85°C (-40° to 185°F)
Water rating	IEC 60529 IPX7
Material	Plastic
Input voltage	From 10 to 45 Vdc
Rated input voltage	12/24/36 Vdc
Typical input current	< 1 mA @ 12 Vdc
Max input current	10 mA @ 12 Vdc
Fuse (on the power cable)	2 A mini-blade type
Power cable length	2 m (6.6 ft.)
Battery type	Two AA batteries (Alkaline, NiMH, or lithium. Not included.)
Battery life	At least 1 year
Radio frequency	2.4 GHz @ 0.72 dBm nominal
Compass-safe distance	60 cm (2 ft.)

⁵

Withstands incidental exposure of water up to 1 m for up to 30 min.

