

B175HW screenshot courtesy of Humminbird

Tilted Element Chirp Transducers

As Chirp technology remains at the forefront of echo sounder development, AIRMAR continues to add transducers for every installation type.

When performance matters most, we've got you covered.

The Benefits of AIRMAR's Chirp-ready Transducers

- One broadband transducer covers up to 117 kHz of bandwidth – greater opportunities to detect fish in the water column
- Superior resolution – precise separation between baitfish and gamefish represented on the display with crisp images
- Enhanced bottom fishing – resolve targets close to the bottom or near structure/wrecks
- Amazing detail – recognize haloclines and thermoclines
- Improved signal to noise ratio – find fish and track bottom at high boat speeds



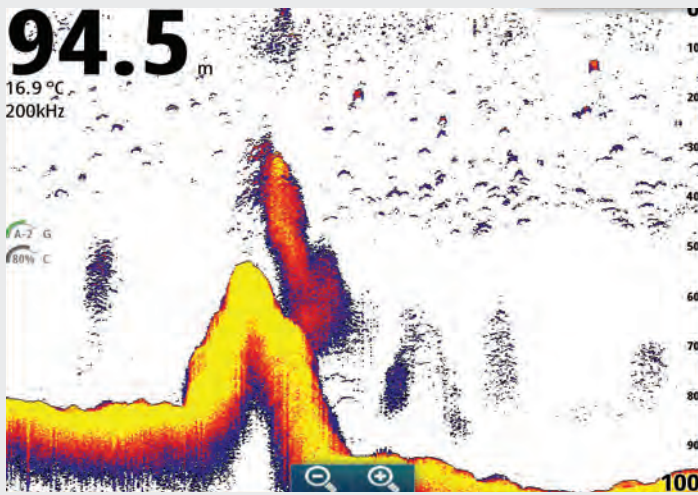

Courtesy of Navico

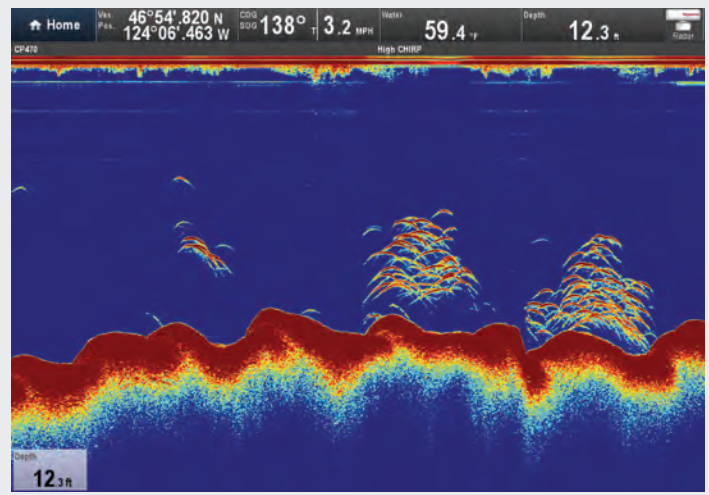

Courtesy of Raymarine



Benefits of Tilted Element Transducers

- The transducer's ceramic elements are permanently tilted inside the housing to compensate for the hull deadrise. This ensures the beam is aimed straight down, resulting in maximum echo returns and eliminating the need for a fairing
- Low profile design extends only 6mm below the hull and is available in stainless steel and bronze
- Can be installed on trailered boats
- For hulls under 35 feet, performance closely compares to that of a fairing type installation

Flush/tilted transducers mount through a hole drilled in any fiberglass, metal or wooden hull, with the outside of the fitting flush against the exterior hull surface. Inside the fitting, the transducer's active elements are permanently tilted to 0, 12 or 20 degree angle to compensate for the hull deadrise, ensuring the sonar beam is aimed straight down.

The flush-mount design of these transducers allows for smooth water flow over the hull, meaning less drag and minimal effect on boating performance.

The best fishing stories begin with the right transducer.

Why does frequency matter?

Selecting the best frequency for your specific application is very important. The good news is that once you know what frequency will work best for the type of fishing you do, there's an AIRMAR transducer designed to maximize the performance of your sounder.

AIRMAR Chirp transducers are available in various frequency combinations:

- Dual Band:
 - Low/High (LH)
 - Low/Medium (LM)
 - Low/High Wide (LHW)
 - Low Wide/Medium (LWM)
- Single Band:
 - Low
 - Medium
 - High
 - High Wide

Low Frequency = Greater Depth (ex. 42-65 kHz)

- Sound waves will not present as clear a picture of the bottom on the display, but will sound down in very deep areas where high frequency sound waves cannot reach
- Provides greater depth range, wider beamwidth, and ultimately more coverage under the boat
- Chirp signal processing technology used with AIRMAR broadband, Chirp-ready transducers provides more detail at greater depths and is less susceptible to noise
- Great for operating at high boat speeds

High Frequency = Greater Detail (ex. 130-210 kHz)

- More sensitive to small targets and will send back detailed information which will display as crisp, high-resolution images on the echosounder screen
- Best for shallower water and popular with anglers fishing at depths less than 1500 feet

Medium Frequency = The Best of Both Worlds (ex. 80-130 kHz)

- Provides the ability to sound deeper than the high frequency, along with better resolution than the low frequency
- Wider beam than the high frequency, achieving more coverage under the boat and greater opportunity to find fish
- Clear images at higher boat speeds

Tilted Element 300 W



Features:

- Depth & fast-response water-temperature sensor
- Hull Type: Wood, fiberglass and metal stepped, planing or displacement type hulls
- Hull Deadrise: Up to 24°
- Fixed 20° tilted version for 16° to 24° hull deadrise
- Fixed 12° tilted version for 8° to 15° hull deadrise
- Fixed 0° tilted version for 0° to 7° hull deadrise
- Engine Type: Can be used with all propulsion types

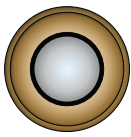

1-Internal
Broadband Ceramic
Assembly

DIMENSIONS

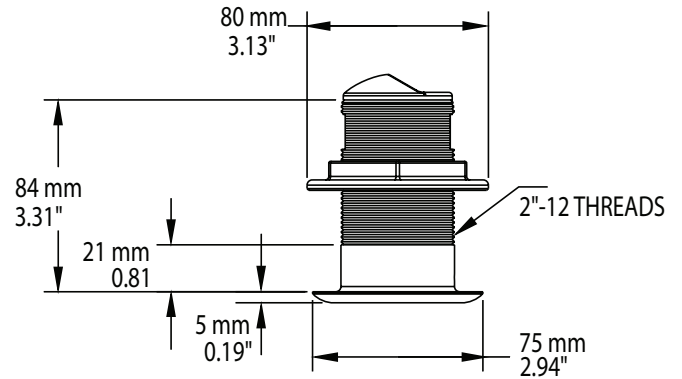

B150M

Medium Frequency

- Medium—95 kHz to 155 kHz
26° to 17° beamwidth
Maximum depth 600 ft
- 60 kHz of total bandwidth from one transducer

Bottom Coverage Relative to Frequency and Depth

Depth	Beam Coverage at Medium Frequency	
	B150M 95 kHz-155 kHz	
50 ft	24 ft	
100 ft	46 ft	
300 ft	138 ft	
600 ft	278 ft	
1000 ft	Too Deep	

This chart compares the medium ceramic element inside the transducer, showing the difference in bottom coverage under the boat.

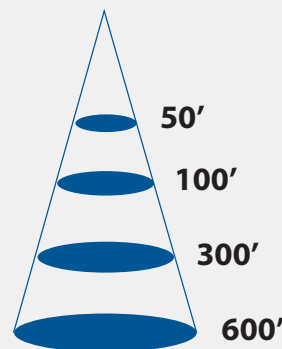

B150M – Medium Frequency
95 kHz-155 kHz

The fish must be in the beam to be represented on the display.

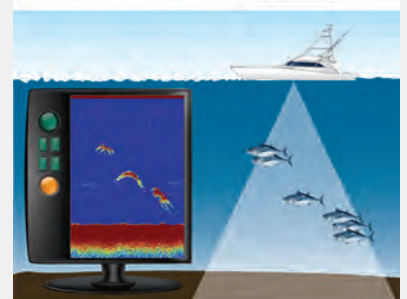
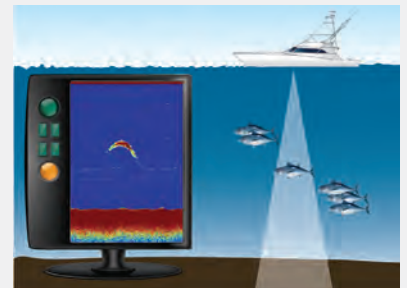

Tilted Element 600 W



DIMENSIONS

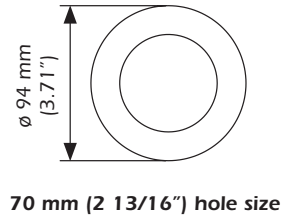
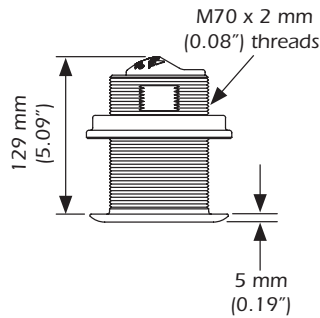

Features:

- Depth & fast-response water-temperature sensor
- Hull Type: Wood, fiberglass and metal stepped, planing or displacement type hulls
- Hull Deadrise: Up to 24°
- Fixed 20° tilted version for 16° to 24° hull deadrise
- Fixed 12° tilted version for 8° to 15° hull deadrise
- Fixed 0° tilted version for 0° to 7° hull deadrise
- Engine Type: Can be used with all propulsion types

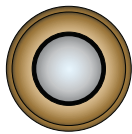

1-Internal
Broadband Ceramic
Assembly

B75H

SS75H (Stainless Steel)

High Frequency

- High—130 kHz to 210 kHz
15° to 9° beamwidth
Maximum depth 700 ft
- 80 kHz of total bandwidth from one transducer

B75M

SS75M (Stainless Steel)

Medium Frequency

- Medium—80 kHz to 130 kHz
24° to 16° beamwidth
Maximum depth 900 ft
- 50 kHz of total bandwidth from one transducer

B75L

SS75L (Stainless Steel)

Low Frequency

- Low—40 kHz to 75 kHz
32° to 21° beamwidth
Maximum depth 1200 ft
- 35 kHz of total bandwidth from one transducer

*This model is 300 W.

Bottom Coverage Relative to Frequency and Depth

Depth	Beam Coverage at Different Frequencies		
	B75H 130 kHz-210 kHz	B75M 80 kHz-130 kHz	B75L 40 kHz-75 kHz
50 ft	14 ft	22 ft	28 ft
100 ft	26 ft	42 ft	58 ft
300 ft	78 ft	128 ft	172 ft
600 ft	158 ft	256 ft	344 ft
1000 ft	Too Deep	Too Deep	574 ft
1500 ft	Too Deep	Too Deep	Too Deep

This chart compares the high, medium and low ceramic elements inside the transducer, showing the difference in bottom coverage under the boat.

Models are also available in stainless steel.

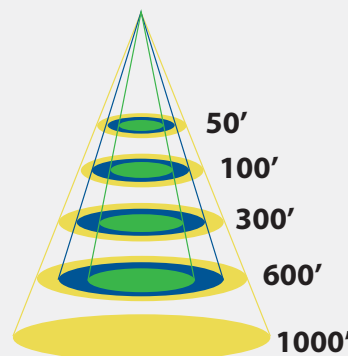

- B75L – Low Frequency
40 kHz-75 kHz
- B75M – Medium Frequency
80 kHz-130 kHz
- B75H – High Frequency
130 kHz-210 kHz

The fish must be in the beam to be represented on the display.

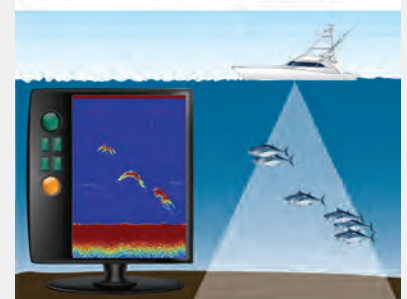
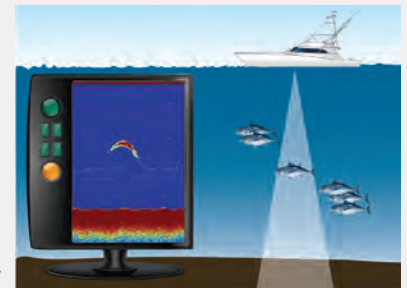

Tilted Element 1 kW



DIMENSIONS

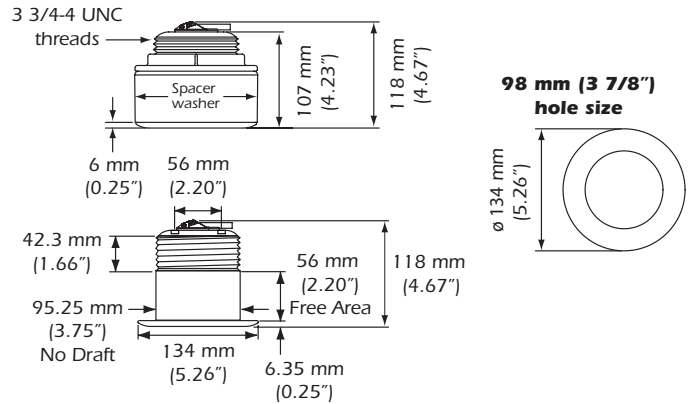

Features:

- Depth & fast-response water-temperature sensor
- Hull Type: Wood, fiberglass and metal stepped, planing or displacement type hulls
- Hull Deadrise: Up to 24°
- Fixed 20° tilted version for 16° to 24° hull deadrise
- Fixed 12° tilted version for 8° to 15° hull deadrise
- Fixed 0° tilted version for 0° to 7° hull deadrise
- Engine Type: Can be used with all propulsion types

1-Internal
Broadband Ceramic
Assembly
B175M/H/HW

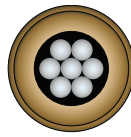
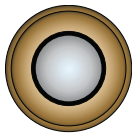

7-Internal
Broadband Ceramic
Assemblies
B175L

B175H

SS175H (Stainless Steel)

High Frequency

- High—130 kHz to 210 kHz
10° to 6° beam
Max. depth 1000 ft
- 80 kHz of total bandwidth from one transducer

B175M

SS175M (Stainless Steel)

Medium Frequency

- Medium—85 kHz to 135 kHz
16° to 11° beam
Max. depth 1500 ft
- 50 kHz of total bandwidth from one transducer

B175L

SS175L (Stainless Steel)

Low Frequency

- Low—40 kHz to 60 kHz
32° to 21° beam
Max. depth 2500 ft
- 20 kHz of total bandwidth from one transducer

WIDE
BEAM

B175HW

SS175HW (Stainless Steel)

High Wide Frequency

- High—150 kHz to 250 kHz
25° constant beam
Max. depth 500 ft
- 100 kHz of total bandwidth from one transducer

Bottom Coverage Relative to Frequency and Depth

Depth	Beam Coverage at Different Frequencies			
	B175H 130 kHz- 210 kHz	B175M 85 kHz- 135 kHz	B175HW 150 kHz- 250 kHz	B175L 40 kHz- 60 kHz
50 ft	10 ft	14 ft	22 ft	28 ft
100 ft	20 ft	28 ft	44 ft	58 ft
300 ft	58 ft	84 ft	134 ft	166 ft
600 ft	116 ft	168 ft	266 ft	332 ft
1000 ft	192 ft	282 ft	Too Deep	554 ft
2000 ft	Too Deep	Too Deep	Too Deep	1110 ft

This chart compares the high, medium, low and high wide ceramic elements inside the transducer, showing the difference in bottom coverage under the boat.

Models are also available in stainless steel.

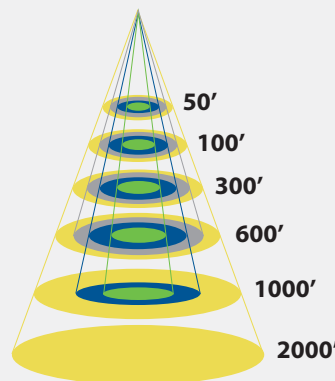

- B175L – Low Frequency
40 kHz-60 kHz
- B175HW – Wide beam Frequency
150 kHz-250 kHz
- B175M – Medium Frequency
85 kHz-135 kHz
- B175H – High Frequency
130 kHz-210 kHz

The fish must be in the beam to be represented on the display.

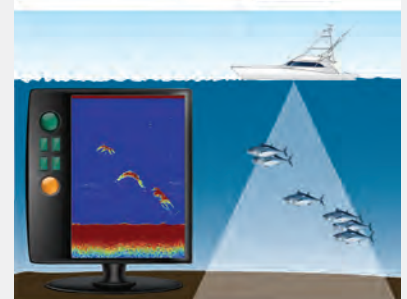
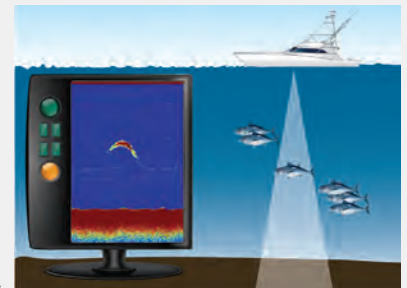

The Chirp Advantage

Traditional sounders operate at only two discrete frequencies – typically 50 kHz and 200 kHz. This results in limited depth range, resolution, and ultimately what targets can be detected in the water column.

In contrast, AIRMAR's game-changing Chirp-ready transducers provide over 70+ kHz of bandwidth. Transmitting over a wide frequency band results in a greater opportunity to detect what is in the water column. As a result, all targets detected in the entire bandwidth will be seen on the display—even those fish holding close to the bottom—ultimately improving target detection, detail, and range resolution.

Most Chirp transducers vary their beam width as they sweep through their frequency range (low, medium, and high). At the lowest frequency the beam is the widest and it narrows as the frequency increases.

AIRMAR's new wide beam Chirp transducers are the exception to this rule and have a fixed beam width of either 25° or 40° across the frequency band. This translates into even more coverage under the boat, revealing more fish in the water column than ever before.

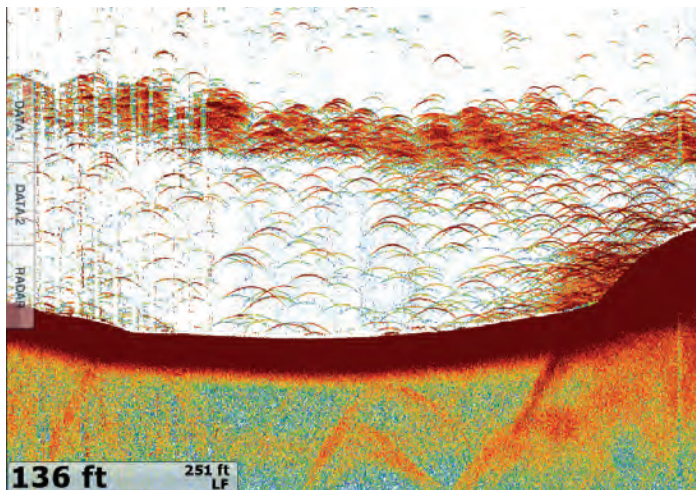

Courtesy of Furuno

Additional Mounting Options



Choosing your mounting option depends on the design of the hull as well as the material it's manufactured with, the boats intended use, and the desired level of performance.

Need Help Choosing the Right Transducer?

Download the free, award-winning iNstall app! It's a great tool that takes the guesswork out of selecting the right transducer for your application. Based on frequency, mounting, housing, and cable options, iNstall will reveal the available option(s) and give you instant access to their specifications. Designed for iPhone, iPad and iPod smart phones and tablets running iOS 6.1 and newer.



iNstall

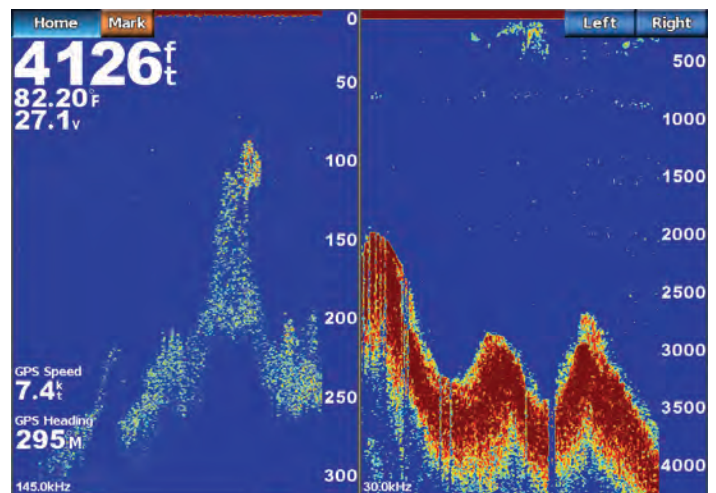

Courtesy of Garmin



www.airmar.com

©Airmar Technology Corporation

TitledElementChirp_BR2017_rD 09/20/17

As AIRMAR constantly improves its products, all specifications are subject to change without notice. All AIRMAR products are designed to provide high levels of accuracy and reliability, however they should only be used as aids to navigation and not as a replacement for traditional navigation aids and techniques. Xducer ID™ is a registered trademark of Airmar Technology Corporation. Other company or product names mentioned in this document may be trademarks or registered trademarks of their respective companies, which are not affiliated with AIRMAR.