

# GS-200

SERIES

ULTRA PERFORMANCE CNC TURNING CENTERS

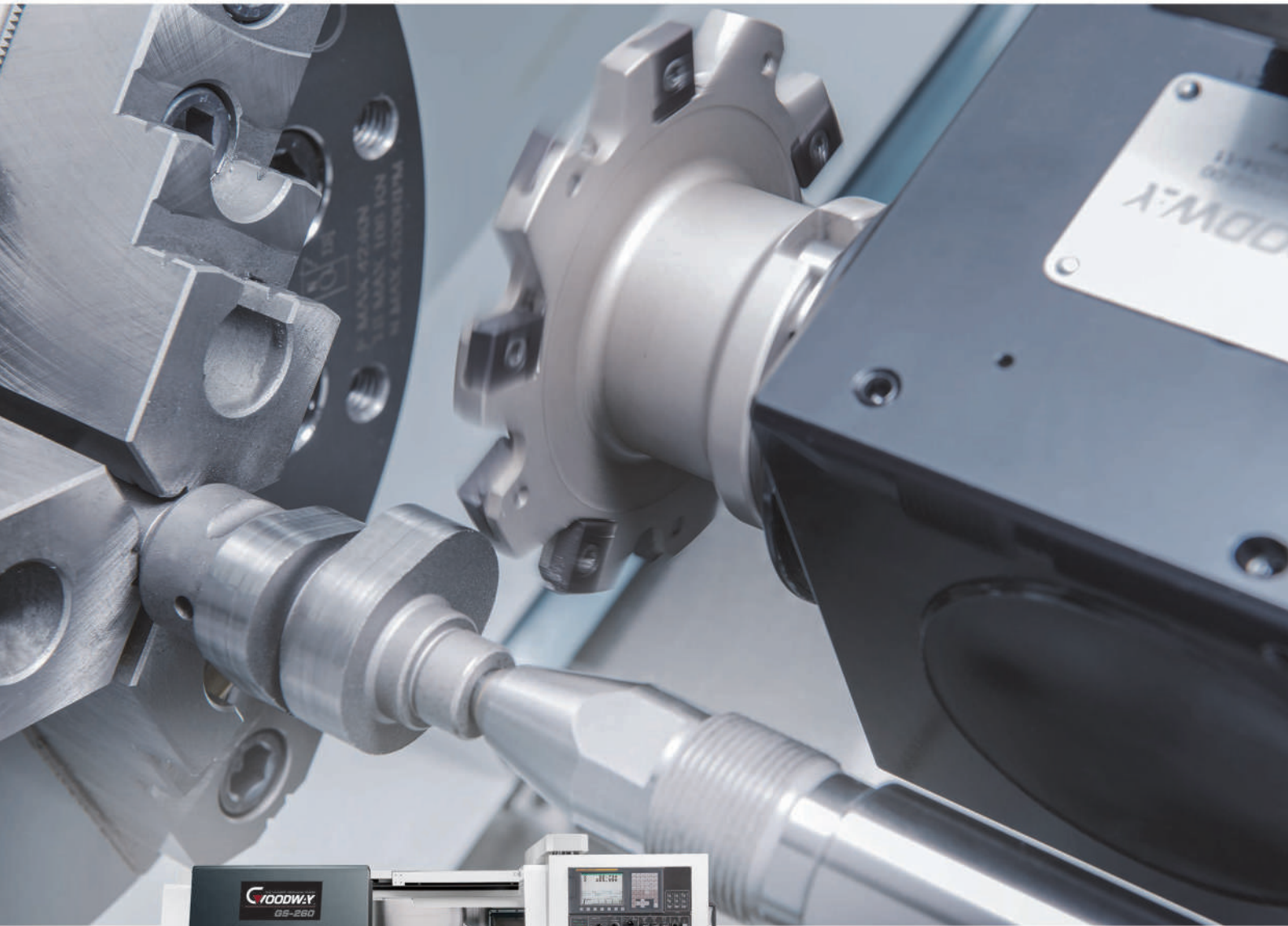

THE ULTIMATE MACHINING POWER  
**WOODWAY**

# ULTRA PERFORMANCE CNC TURNING CENTERS

Packed with industry leading technology and top quality components, the GOODWAY GS-200 series turning centers combine incredible power, strength, and speed to bring you The Ultimate Machining Power®. These powerful ultra performance machines will easily accomplish the demanding turning applications of today and tomorrow. 2 bed lengths ( utilizing the same advanced design ) and 3 spindle sizes offer a total of 6 basic model configurations to suit your application. Furthermore, with available live tooling, C-axis, Y-axis, and sub-spindle capabilities, milling, drilling, and front / back-end turning applications may be completed in one single machine.

- ▶ 30° true slant-bed design provides smooth chip disposal and easier operator access.
- ▶ Stainless steel way covers and special steel wipers molded with industrial strength rubber are used for durability.
- ▶ Fully enclosed splashguards keep chips and coolant contained for a safe clean working environment.
- ▶ The auto lubrication system delivers metered amounts of lubrication to the slide ways, ball screws, and vital components. Distribution is automatically shut off during idling to prevent waste.



( GS-260 model shown with optional accessories. )

Chuck Size		8"	10"	10" ( Big- bore )
Bar Capacity		Ø 51 mm ( 2.0" )	Ø 65 mm ( 2.5" )	Ø 75 mm ( 3.0" )
Turning Length	24.5" ( 600 mm ) <sup>*1</sup>	GS-200 / S / M / MS / Y / YS	GS-260 / S / M / MS / Y / YS	GS-280 / S / M / MS / Y / YS
	47.4" ( 1,200 mm ) <sup>*1</sup>	GS-200L / LS / LM / LMS / LY / LYS	GS-260L / LS / LM / LMS / LY / LYS	GS-280L / LS / LM / LMS / LY / LYS

L: Long Bed M: Live Tooling & C-axis S: Sub-spindle Y: Y-axis

<sup>\*1</sup> Turning length listed here are approximate numbers, individual models may vary. Please see Machine Specifications page for details.



( GS-280LM model shown with optional accessories. )

- ▶ The built-in spindle type tailstock provides maximum rigidity and load capacity. The extension and retraction of the quill is programmable and thrust pressure adjustable.
- ▶ Available programmable base tailstock saves manpower and enables many critical applications to be performed efficiently. Positioning of the tailstock has been simplified through use of custom software interface. The Z-axis carriage automatically locks on to the base of the tailstock and drags it to the desired position.

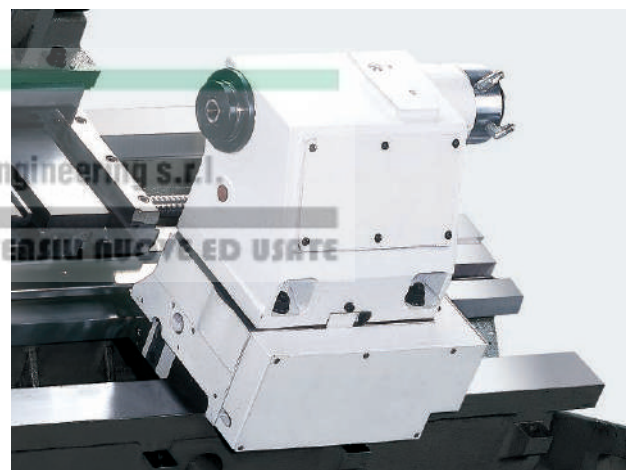

- ▶ Coolant system features a roll-out coolant tank for easy maintenance and high-pressure coolant pump for increased tooling cooling power.



# MAXIMUM STRENGTH CONSTRUCTION

- ▶ Major structural components have been combined into one solid platform. The low center of gravity 30° true slant bed design provides the most rigid foundation possible for the headstock, turret, and tailstock.
- ▶ By using Finite Element Methods ( FEM ), optimal reinforce ribbings are directly cast into the one-piece bed structure. Mechanical rigidity has been increased by more than 40% when compared to conventional designs. The GS-200 series is capable of performing super heavy-duty turning and maintain long-term super high-precision accuracy. More rigidity also means extended tool life.
- ▶ Built to endure years and years of rigorous high production turning, the heavily ribbed, one-piece thermally balanced bed and casting components are of FC35-Meehanite casting ( industry standard is FC25~30 ). FC35 grade cast iron is capable of withstanding much greater stress without deforming and provides maximum vibration dampening, which result in a machine that will outlast and outperform the competition.

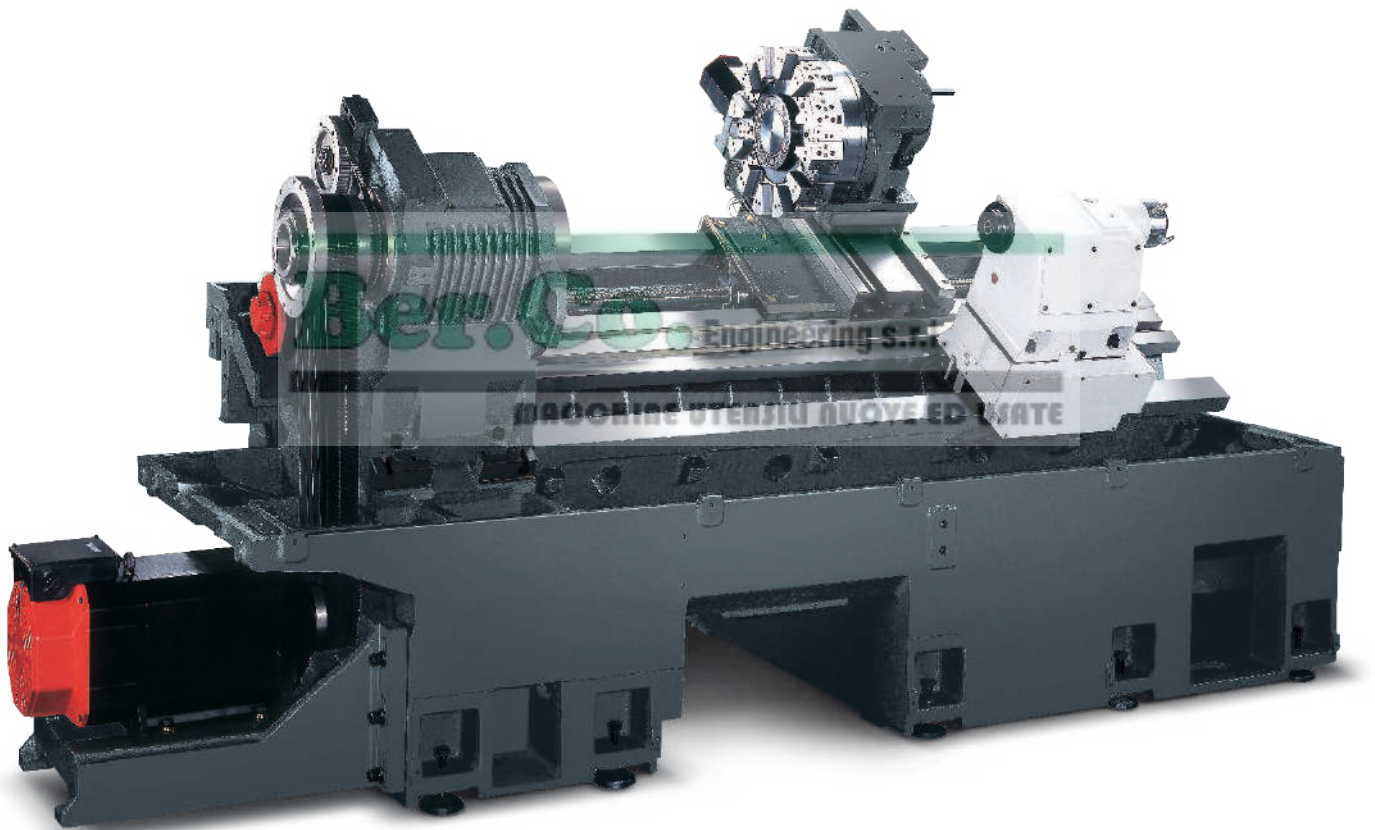

( Casting structure of GS-200 series L model shown. )

- ▶ All spindle and servo motors, including drives, are FANUC  $\alpha$  series components to ensure peak machining performance and accuracy.
- ▶ X and Z axes are driven by over-sized FANUC  $\alpha$  series absolute AC servo motors, providing tremendous thrust outputs with faster acceleration and deceleration. Absolute encoder technology saves time and money by eliminating the use of limit switches, thus, eliminating referencing axes to home positions and replacing broken limit switches.

- ▶ C3 class hardened and precision ground ball screws ensure the highest accuracy and durability possible. Plus, pretension on all axes minimizes thermal distortion.



- ▶ Slide ways are bonded with "Turcite B" to eliminate stick-slip, minimize wear and maintain long term accuracy. Rapids are 20 m/min. ( 788 IPM ) on X-axis & 24 m/min. ( 945 IPM ) on Z-axis.
- ▶ Extra wide hardened and ground box ways are directly formed onto the machine bed and saddle during the casting process. They are precision machine and widely spaced for maximum strength. The box way design also provides the rigidity needed for heavy duty and interrupted turning applications.

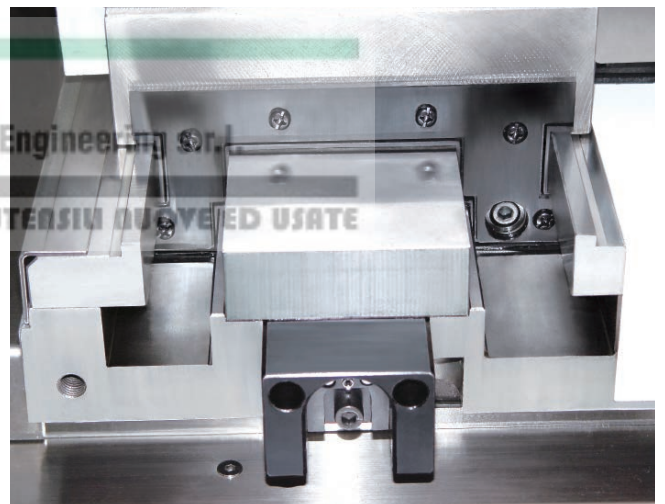

- ▶ Contact surfaces of all slides, headstock, turret, tailstock, and ball screw bearing housings with the machine bed are precision hand scraped to provide maximum assembly precision, structural rigidity, and load distribution.

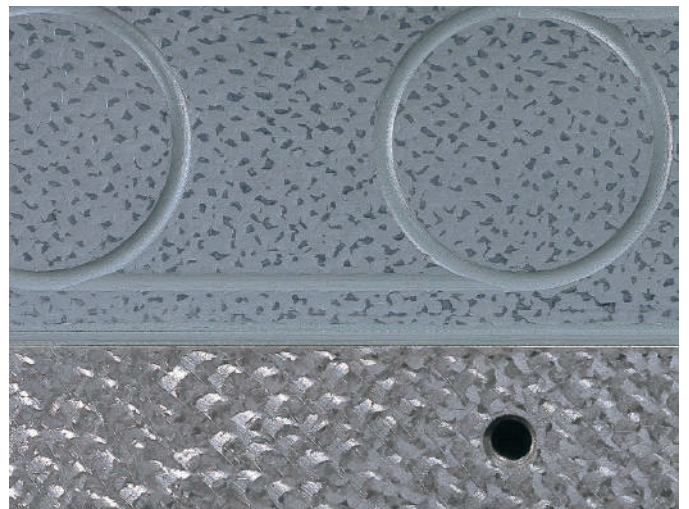

# ULTIMATE TURNING POWER

- ▶ The heavy-duty headstock is of one-piece casting reinforced with heat dispending fins.
- ▶ P4 grade ( Class 7 ) super-high precision bearings are directly assembled for maximum level of support and precision. Bearing configuration is designed for super heavy-duty cutting with ultra-smooth performance and long term durability with a higher level of accuracy.
- ▶ Standard rigid tapping feature provides high-speed precision tapping without the use of floating tap holders. Set-up is easier and depth of thread more accurate, permitting maximum productivity for tapping operations.
- ▶ Standard spindle orientation feature allows the spindle to stop at desired programmed position. Useful in broaching and manual part loading applications where a fixed spindle position is required.

**[ Spindle Nose Dimension Drawing ]**

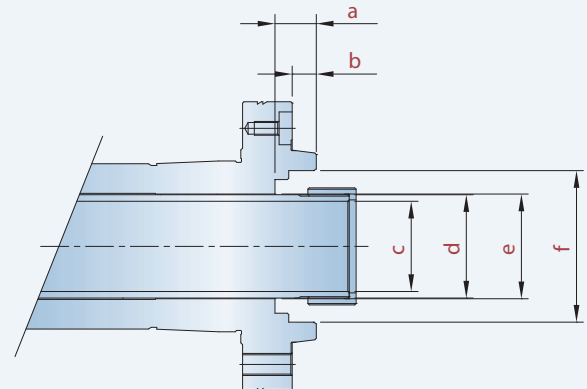

Unit : mm

Model	a	b	c	d	e	f
GS-200/L	20	14.3	Ø 52	Ø 65	Ø 60	Ø 70
GS-260/L	30	17.5	Ø 65.5	Ø 75	Ø 75	Ø 110
GS-280/L	28.5	16	Ø 75.5	Ø 89.8	Ø 89	Ø 110

**[ Spindle Dimension Drawing ]**

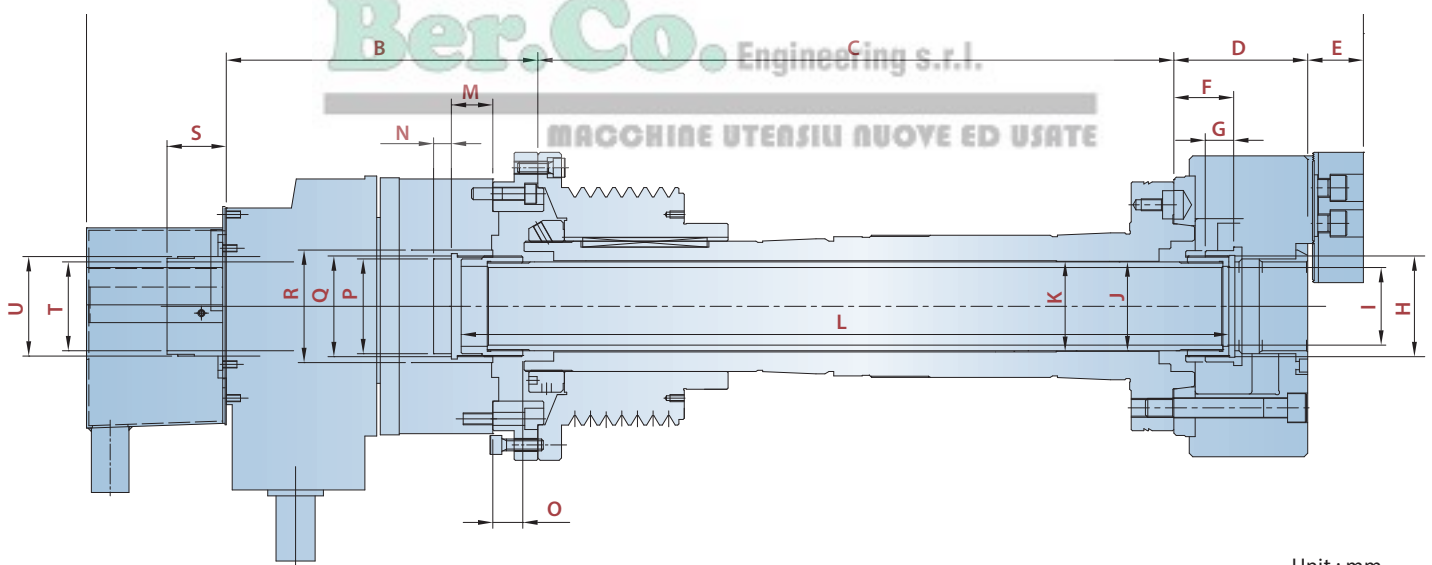

Unit : mm

Model	A	B	C	D	E	F	G	H	I	J	K
GS-200/L	970.6	214	531.5	103	30	Max : 52 Min : 36	20.5	M60xP2.0	Ø 52	Ø 65	Ø 66
GS-260/L	1057	263	536.9	113	43	Max : 51.5 Min : 32.5	25	M85xP2.0	Ø 65.5	Ø 75	Ø 76
GS-280/L	1,154.9	302	583.9	122	51	Max : 54 Min : 31	28	M89xP2.0	Ø 76	Ø 89.8	Ø 90

Model	L	M	N	O	P	Q	R	S	T	U
GS-200/L	624	Max : 30 Min : 8	15	29.4	Ø 55	M60xP2.0	Ø 64	Max : 47 Min : 25	Ø 52	M58xP1.5
GS-260/L	648	Max : 35 Min : 10	15	26.4	Ø 80	M85xP2.0	Ø 89	Max : 50 Min : 25	Ø 75	M84xP2.0
GS-280/L	706	Max : 35 Min : 5	15	45.9	Ø 95	M100xP2.0	Ø 102	Max : 55 Min : 25	Ø 91	M99xP2.0

- ▶ The precision direct belt drive system provides greater spindle control, flexibility and serviceability. Pulley ratios fine tune the motor's maximum RPM to match the spindle's maximum RPM, which result in full output at the lowest RPM possible. Thus, utilizing the full potential of the spindle motor for maximum cutting power.

Standard / High-speed Spindle Output

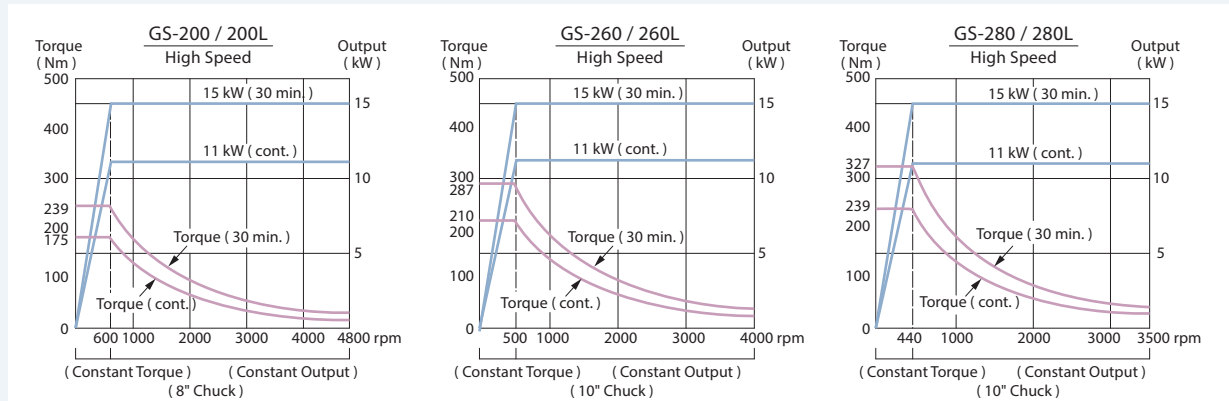

Low-speed Spindle Output

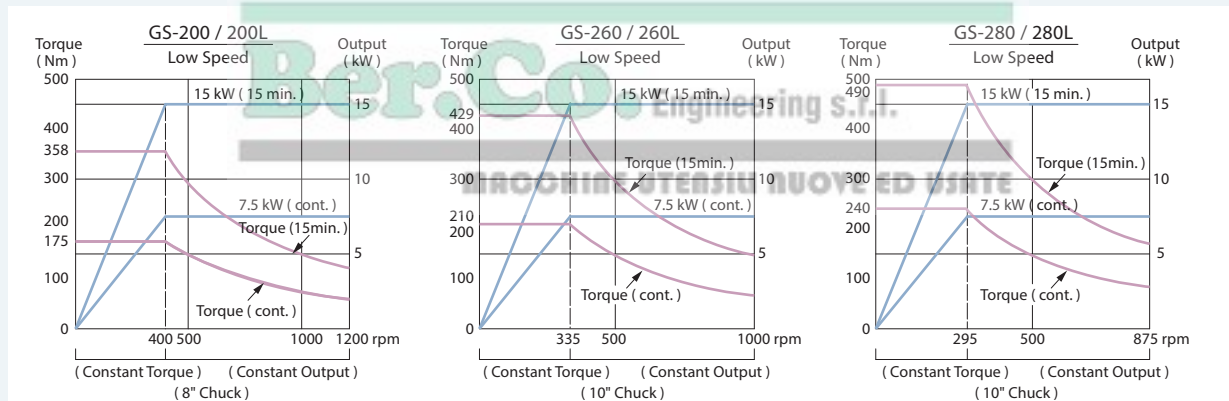

- ▶ Available 2-speed motor configuration further increases the spindle's cutting ability and flexibility. In low range, the motor reaches full output at 1/3 the RPM of standard motors, and torque output is approximately 3 times more. This system offers the advantages of a gear box without the noise, hassle of maintenance, slow gear change, and expensive rebuilds when a gear box wears out.

- ▶ Generating twice the torque output of standard motors, the A/C, constant output, wide-range FANUC  $\alpha$  P22 high-torque *i* series motor is rated at 15 kW ( 30 min ). This double bind motor is designed to reach full output at 1/2 the RPM of standard motors, providing the ability to take heavier cuts in the lower RPM ranges.

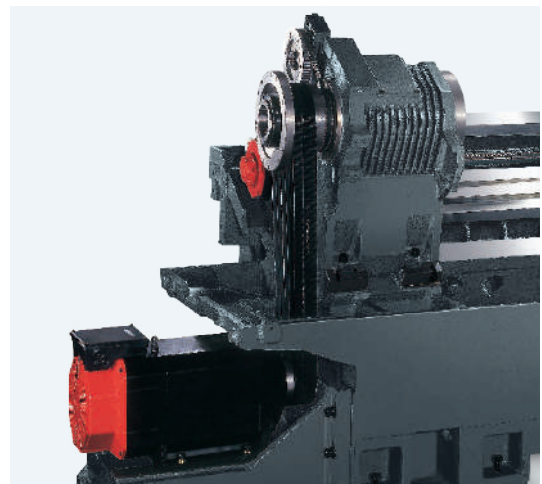

# ADVANCED TURRET TECHNOLOGY

- ▶ The heavy-duty servo indexing turret achieves 0.2 second indexing times for adjacent stations and 0.5 second for stations at the opposite end of the disk. Index movements are single step, without pauses, no matter how many stations are skipped.
- ▶ Ø 220 mm ( 8.67" ) diameter super high precision curvic couplings accurately position the turret disk and 4,000 kg ( 8,800 lb ) of clamping force ensures abundant turret rigidity for all cutting conditions.
- ▶ The standard 12-station turret clears 8" diameter work holding devices without interference, even when loaded with tooling at maximum shank size. The optional 10-station turret clears 10" diameter work holding devices without interference, even when loaded with tooling at maximum shank size.

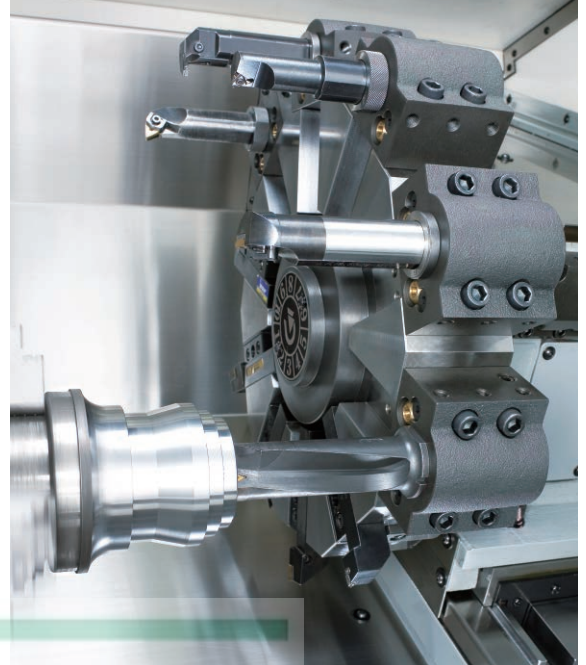
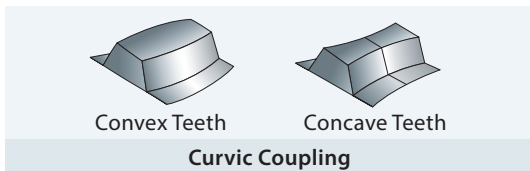

- ▶ The curvic couplings provide a large contact area and are designed with an auto-clean feature not seen on traditional couplings.

**Ber.Co.** Engineering s.r.l.

## ULTIMATE C-AXIS SPINDLE

MACCHINE UTENSILI NUOVE ED USATE

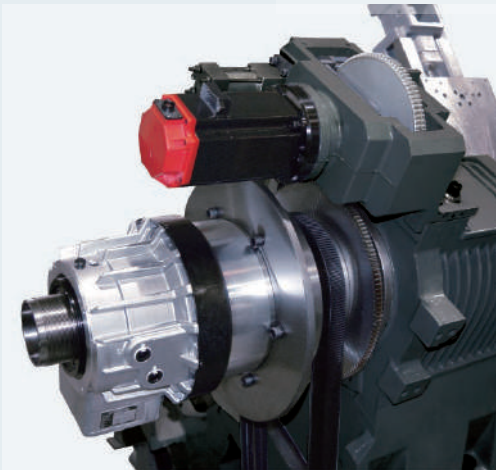

- ▶ The Cf-axis and disk brake system available on the GS-200 series provides the most rigid and powerful type of C-axis on the market today. In Cf-axis mode, a servo motor is engaged and drives the rotation of the spindle ; engagement time is approximately 1 second.
- ▶ Working with the live tooling turret, the Cf-axis and disk brake system enables the machine to perform multiple tasks, such as drilling, tapping, and milling operations, including cylindrical and polar coordinate interpolations ( resembling a 4<sup>th</sup>-axis rotary table on a machining center ).
- ▶ With the FANUC servo motor generating an ultra high resolution of 120 million pulses per spindle rotation and 240 Nm ( 176 ft-lb ) of torque ( cont. ), machined surface finishes are much superior than Cs-axis ( driven by spindle motor ) equipped machines. Plus, dynamic accuracy is within  $\pm 0.02^\circ$  even under heavy cutting loads.

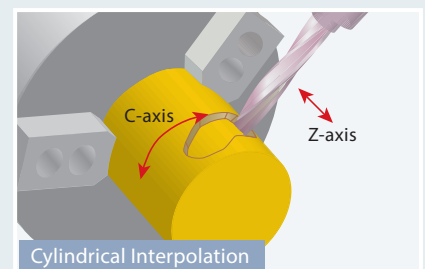
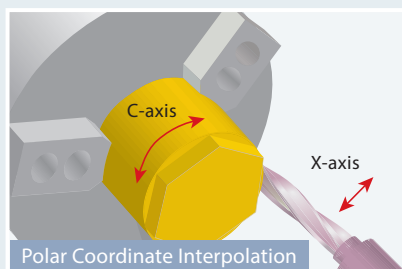
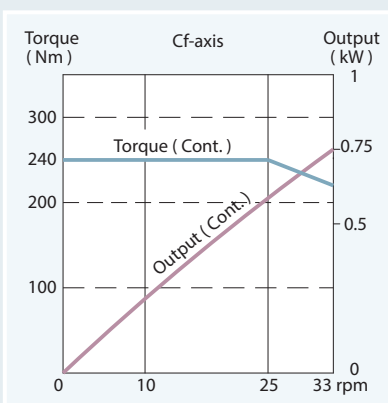



[ CZ-type Turret ]

Work Range

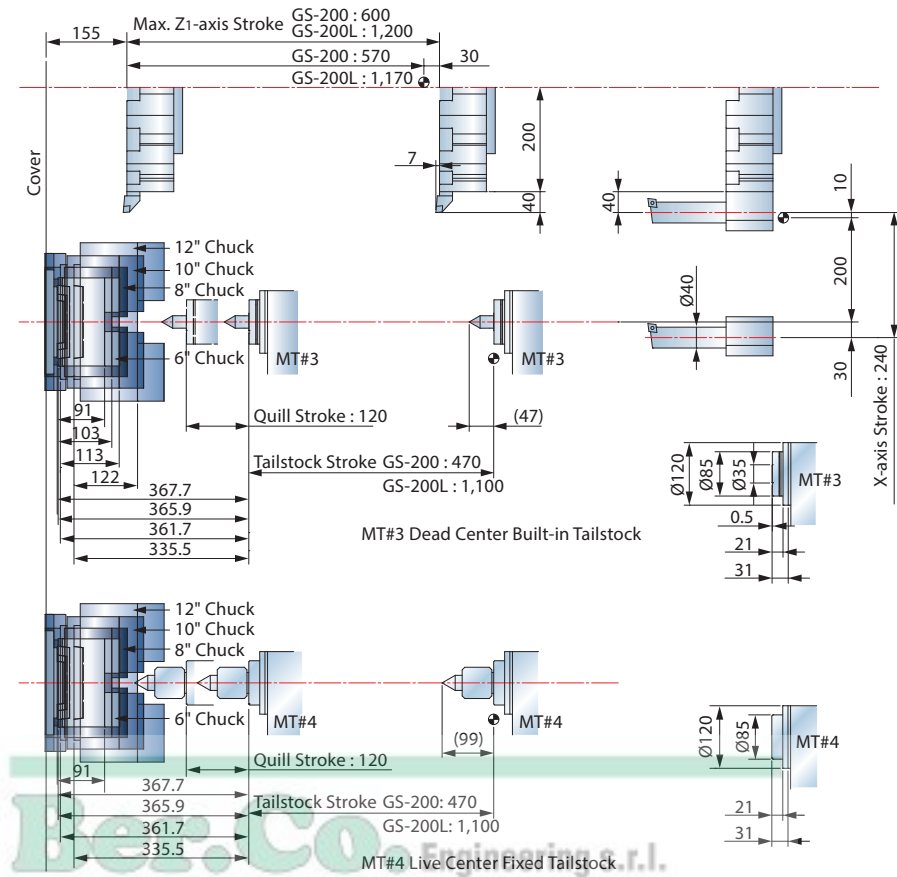

7  
8

Tooling System

Interference Diagram NUOVE ED USATE

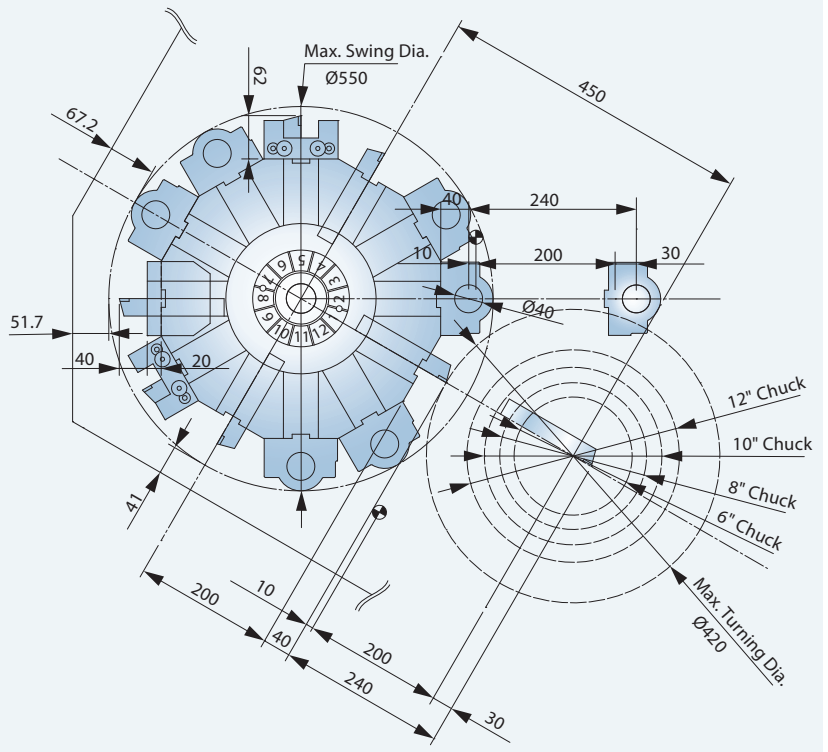
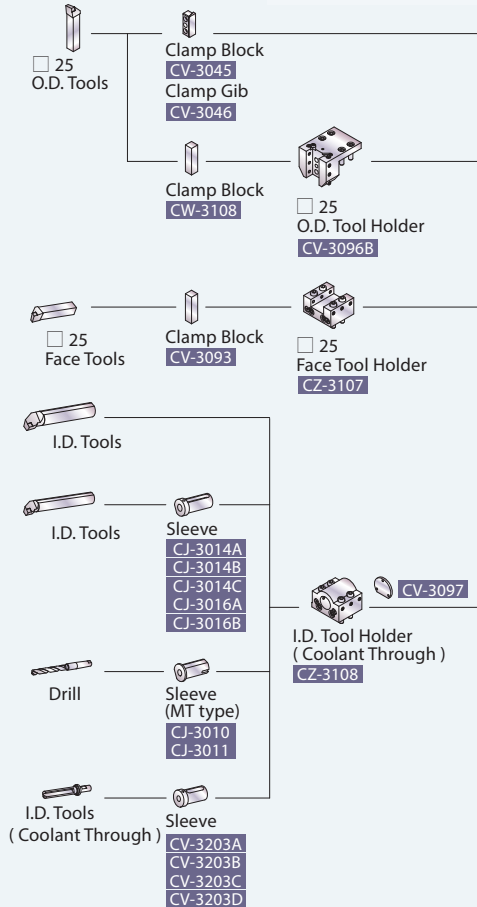

Unit : mm

# POWERFUL LIVE TOOLING TURRETS

- ▶ Live tooling and C-axis control capabilities on the GS-200 series allows the machine to perform multiple tasks on a work-piece, such as turning, milling, drilling and tapping. This eliminates manpower and cycle time, while reducing accuracy lost, which will occur if the part is moved from machine to machine.

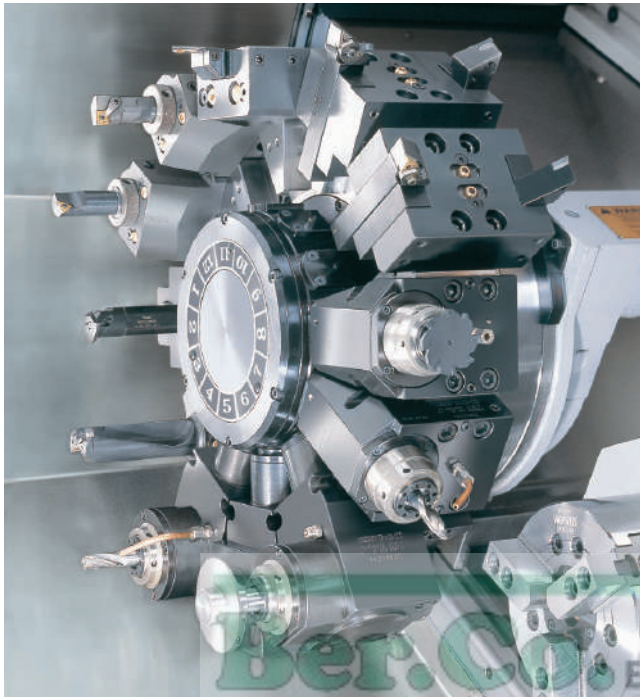

( Live tooling turret & sub-spindle shown. )

- ▶ The 12-station GOODWAY live tooling turret offers 12 stations available for live tooling ( live tooling tools rotate in working position only ) and features a non-lifting turret disk.

## Live Tooling Output

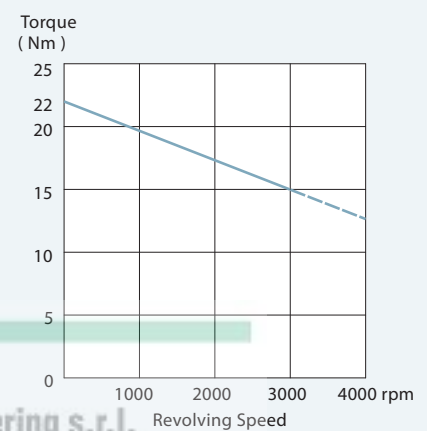

MAGCHINE UTENSILI NUOVE ED USATE

- ▶ GOODWAY's live tooling turret utilizes advance servo indexing technology to achieve 0.2 second indexing times for adjacent stations and 0.5 second for stations at the opposite end of the disk.
- ▶ With the latest technology, live tooling is driven by an AC servo motor to provide ample power, in the form of torque. Now, even the toughest of jobs may be tackled without a sweat.

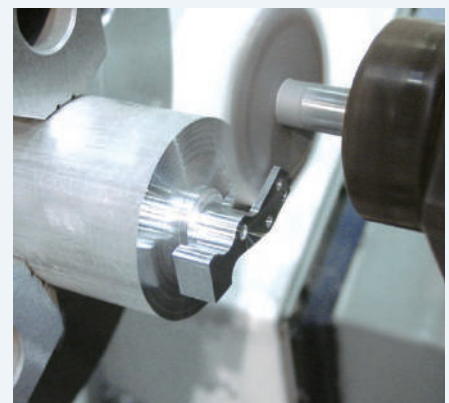
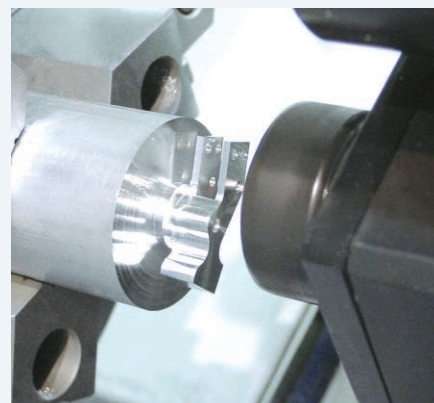
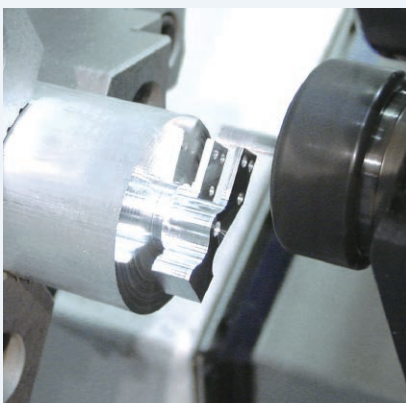
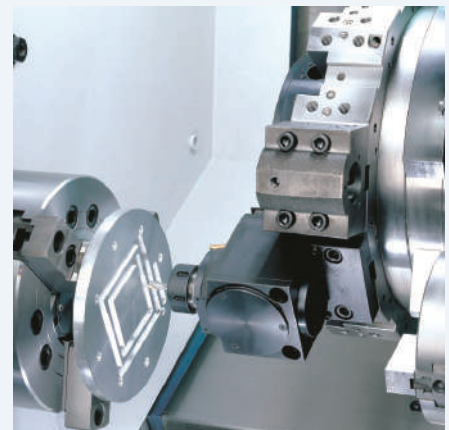

[ Optional 12-Stations Live Tooling Turret ]

Work Range

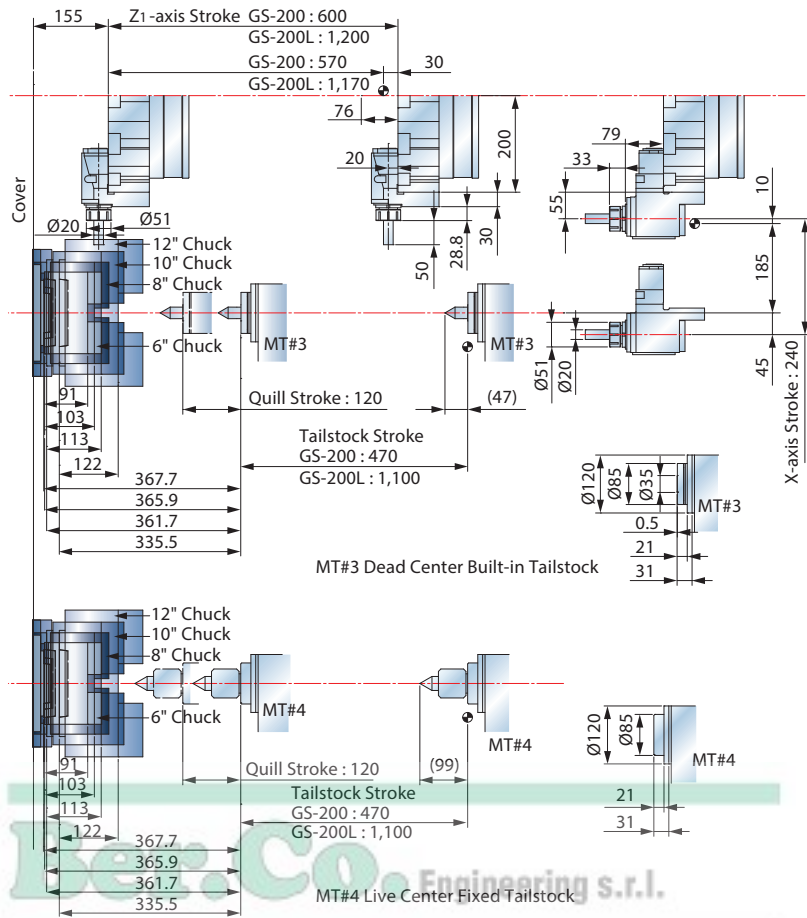

Tooling System

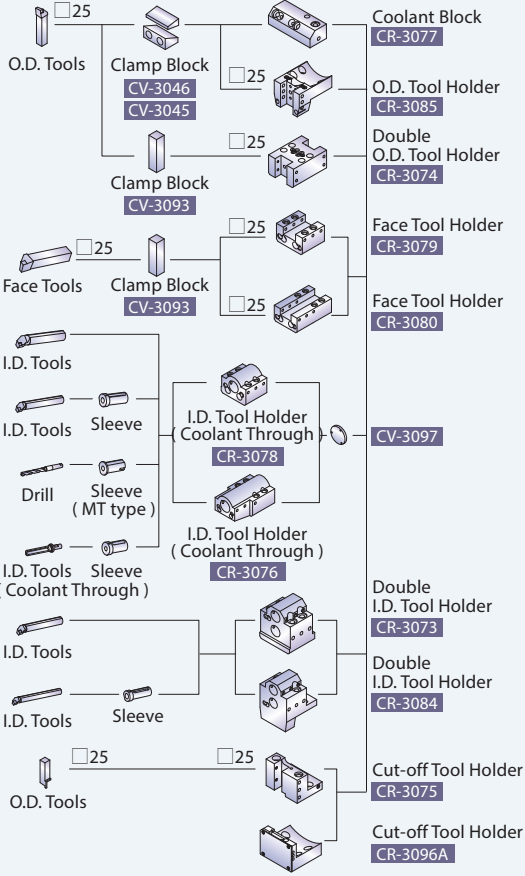

Interference Diagram

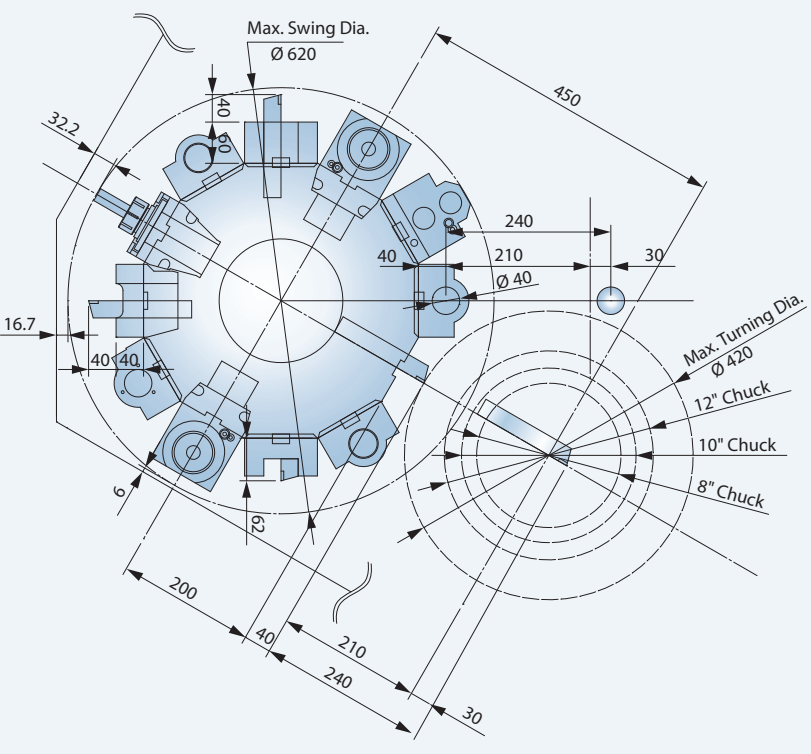

# BACK-END MACHINING CAPABILITY

- ▶ A 6" chuck size sub-spindle driven by a powerful 7.5 kW ( 10 HP, 30 min. ) built-in type FANUC motor ( Integrated Motor ) for back-end machining is available on the GS-200 series.
- ▶ The sub-spindle travels on the B-axis, which has extra wide hardened and ground box ways. The box ways are directly formed onto the machine bed during the casting process. They are precision machined and widely spaced for maximum strength.

Sub-spindle Output

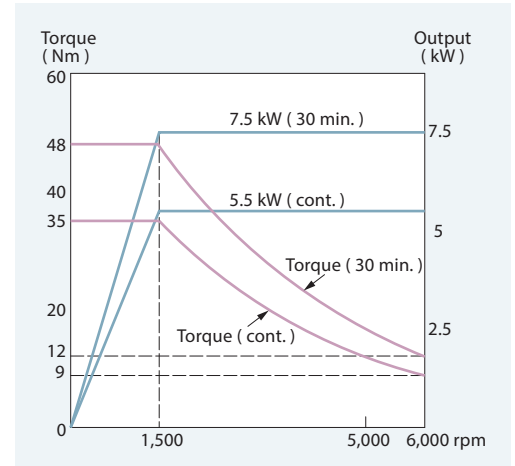

- ▶ Automatic part transfer of work-piece from main spindle to sub-spindle saves manpower and cycle time, while reducing accuracy lost, which will occur if manually handling the part from machine to machine.

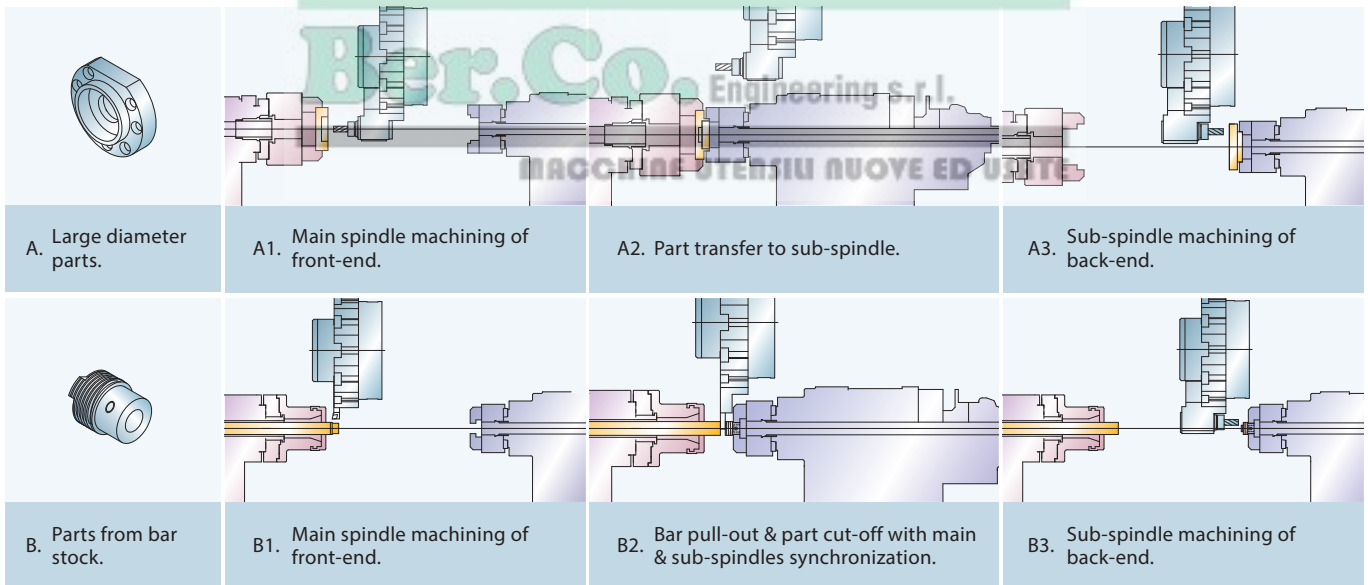

- ▶ With  $\varnothing 38 \text{ mm}$  ( 1.50" ) bar capacity, the sub-spindle configuration is also ideal for machining long work-pieces such as small diameter shafts. Both ends of the work-piece can be supported by the main and sub spindles, allowing the middle section(s) to be accurately machined.

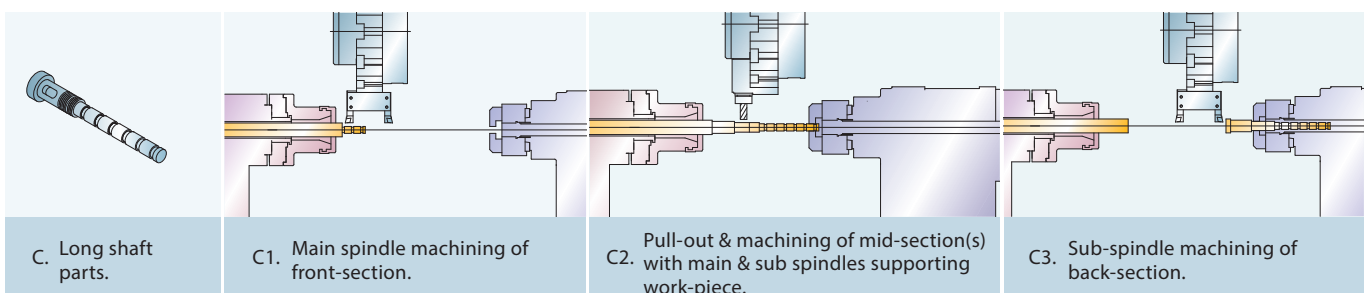

[ Sub-spindle\*1 ]

Work Range  
( I.D. / O.D. Tooling )

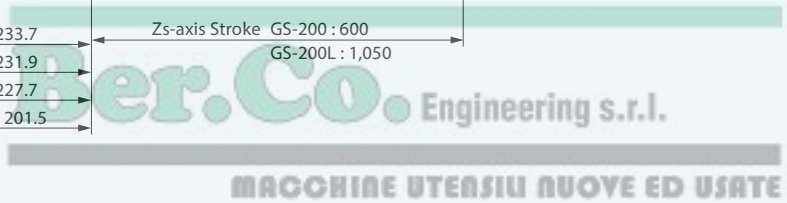
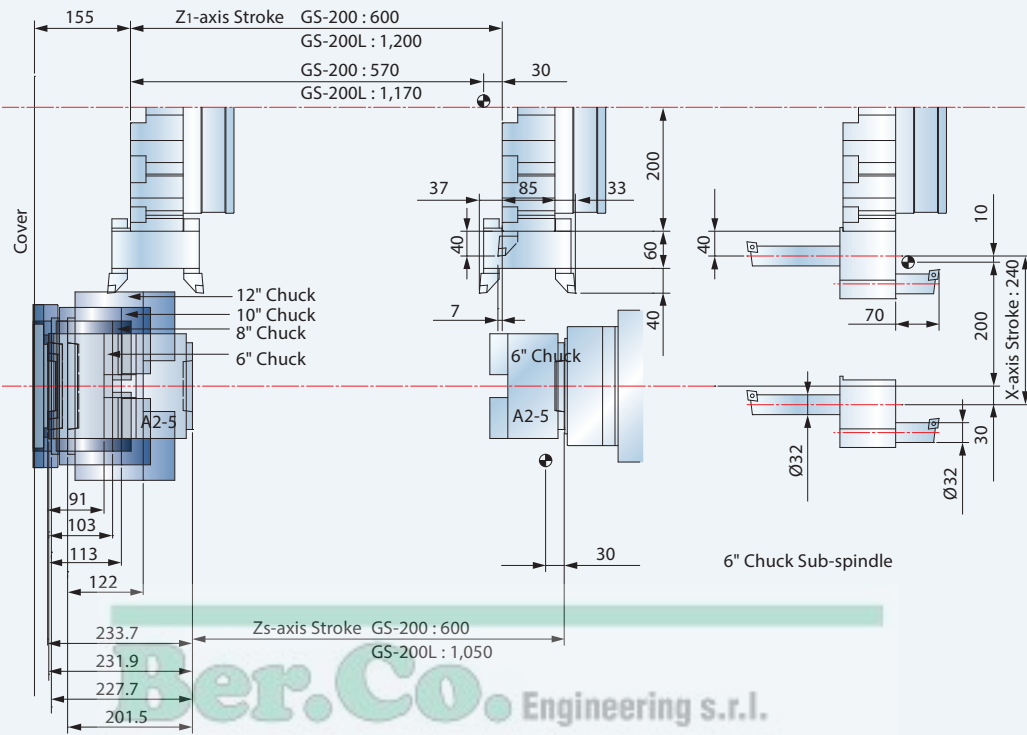

( Live Tooling )

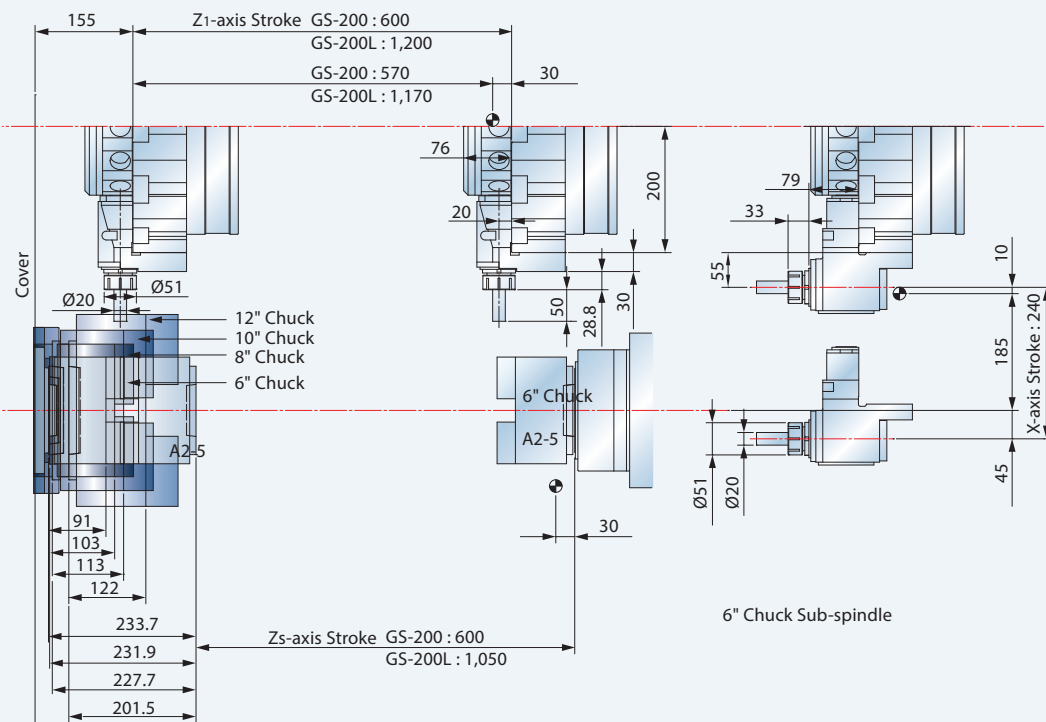

\*1 For S model only, Tooling system & Interference diagram please see page 11 & 13.

# Y-AXIS MACHINING CAPABILITY

- ▶ Y-axis control further enhances multi-tasking live tooling capabilities and improves various machining precision. High precision grooving and X-axis off-center drilling are enabled.
- ▶ With an abundant amount of Y-axis travel, 110 mm = ± 55 mm (4.33" = ± 2.16"), a wide variety of parts may be efficiently machined.

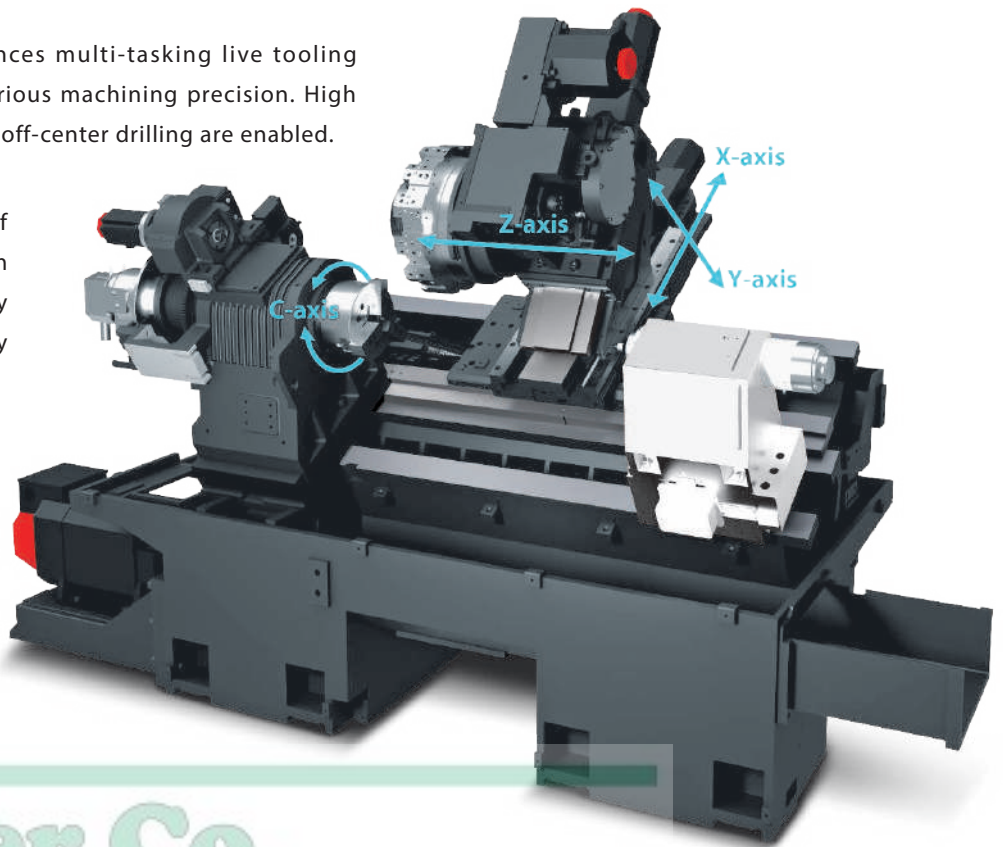

**Ber.Co.** Engineering s.r.l.

- ▶ On Y-axis equipped machines, the turret is mounted on a secondary 30 degrees wedge saddle on top of the X-axis slide. Both X & Y axes have extra wide hardened and ground box ways, which are directly formed onto the saddles during the casting process. They are precision machined and widely spaced for maximum strength.

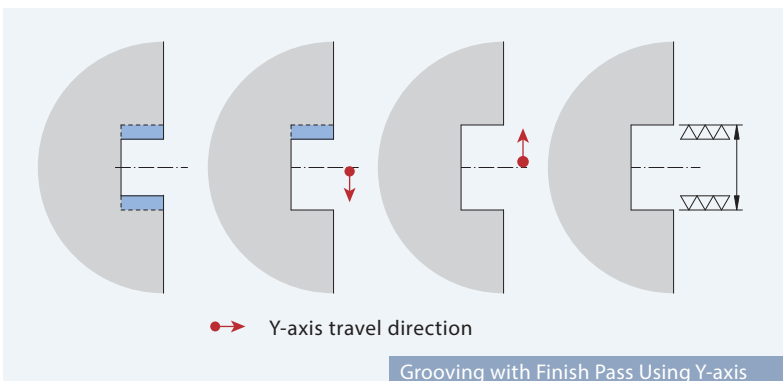
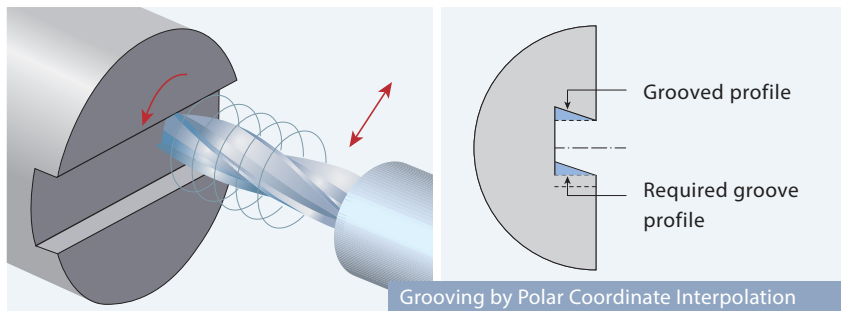
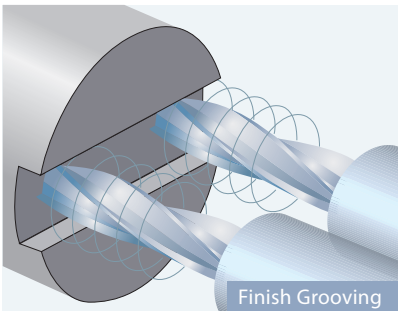
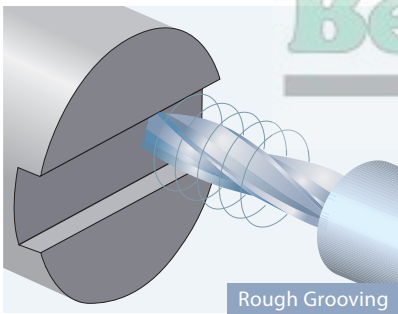

- ▶ Grooving with Y-axis control produces grooves with higher accuracy.

Tooling System

Inference Diagram

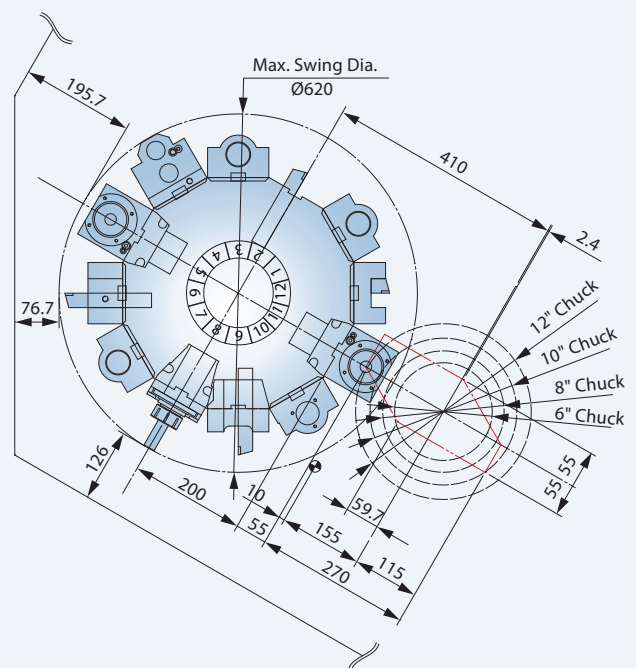
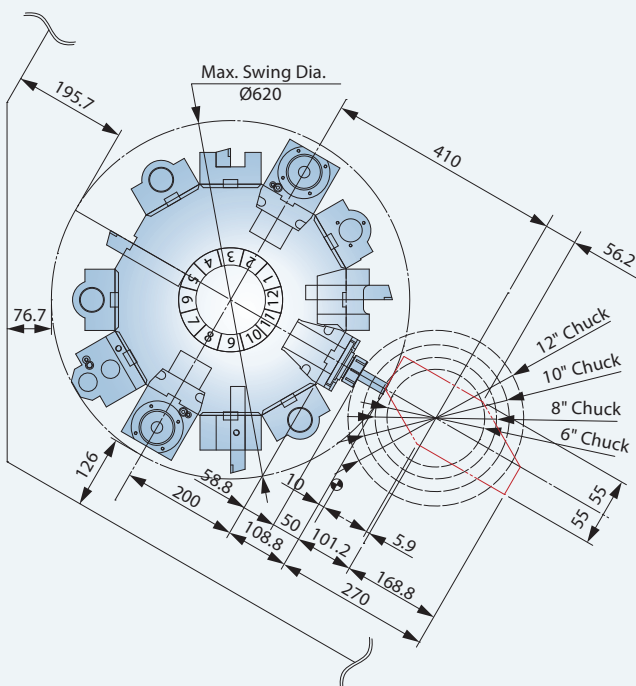
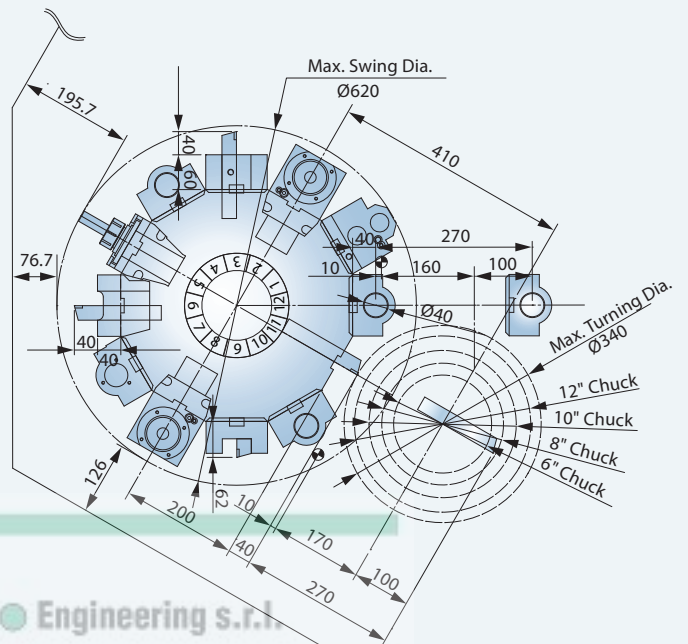
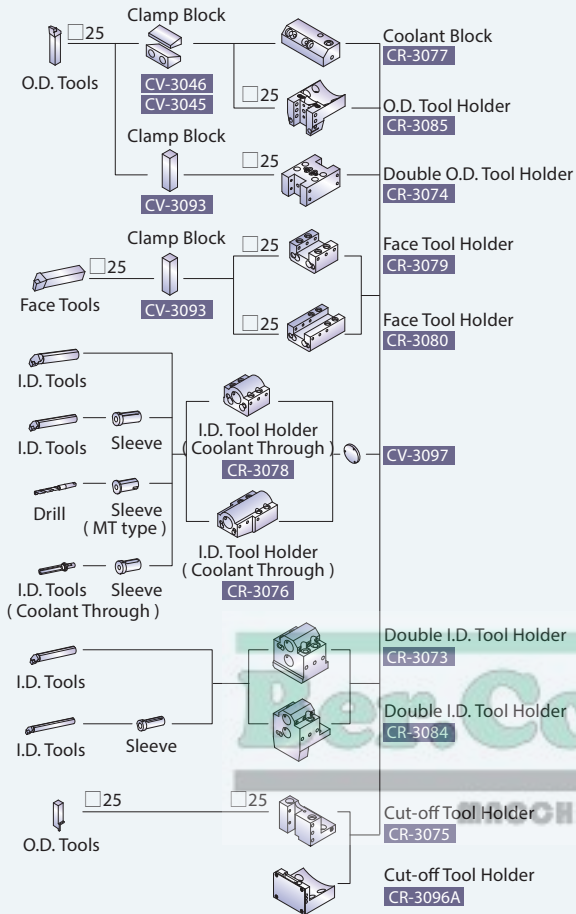

Unit : mm

[ Y-axis & Live Tooling Turret ]

Work Range

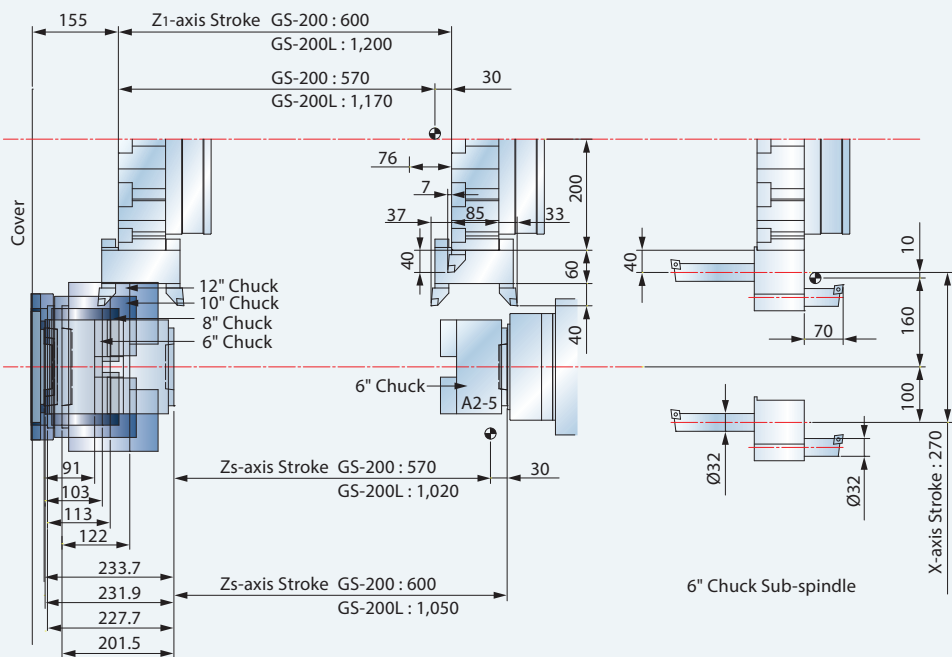
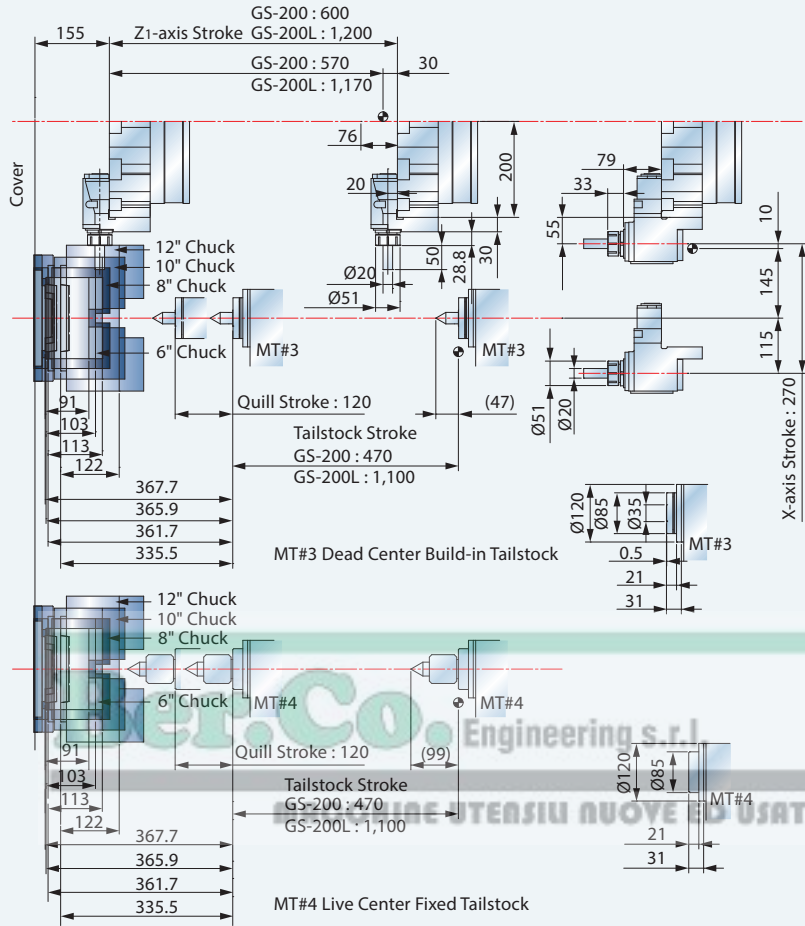

Unit : mm



# MACHINING PERFORMANCE

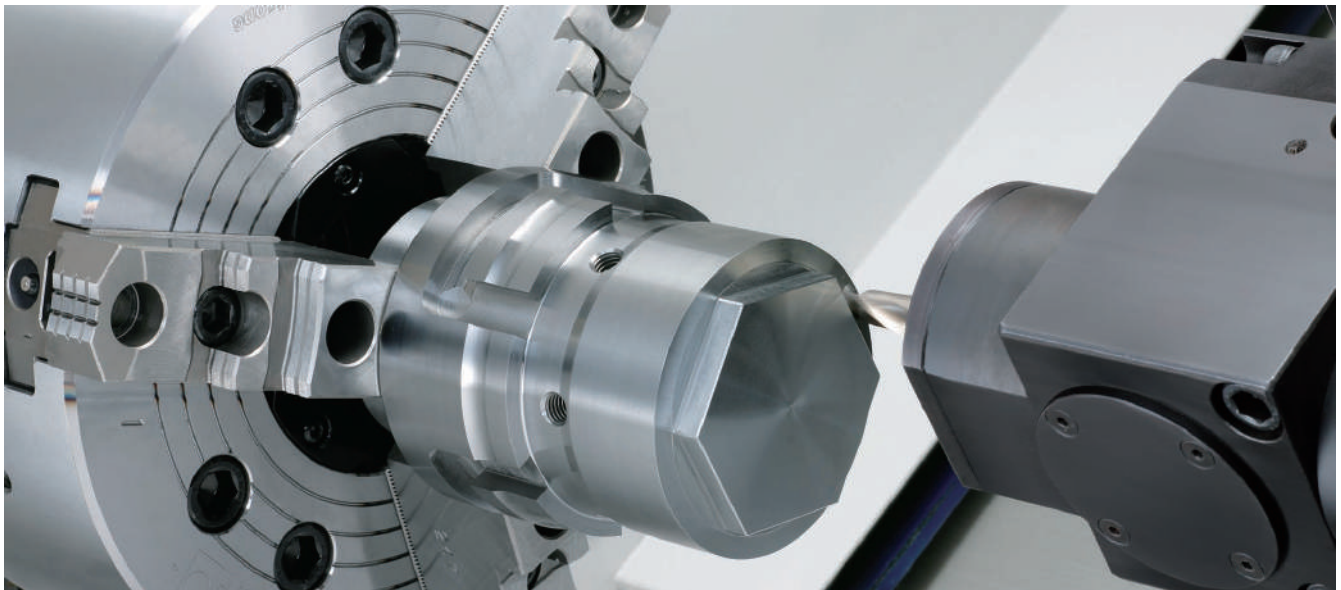

## O.D. Heavy Cutting Example

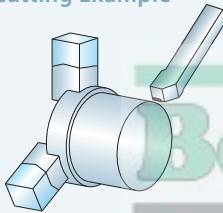

	O.D. Before Cut	O.D. After Cut	Spindle Speed	F/ Rev.	Depth of Cut / side	Spindle Load	Z-axis Load
1	108 mm (4.25")	96 mm (3.77")	500 RPM	0.30 mm (0.0118")	6 mm (0.2362")	97%	56%
2	96 mm (3.77")	82 mm (3.22")	550 RPM	0.32 mm (0.0125")	7 mm (0.2755")	112 %	67 %

Raw Material : S45C Model : GS-200M

## MACCHINE UTENSILI NUOVE ED USATE

## I.D. Heavy Cutting Example

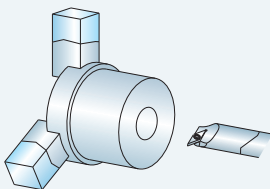

	I.D. Before Cut	I.D. After Cut	Spindle Speed	F/ Rev.	Depth of Cut / side	Spindle Load	Z-axis Load
1	74 mm (2.91")	86 mm (3.38")	850 RPM	0.30 mm (0.0118")	6 mm (0.2362")	138 %	52%
2	86 mm (3.39")	94 mm (3.70")	650 RPM	0.40 mm (0.0157")	4 mm (0.1575")	97 %	48 %

Raw Material : S45C Model : GS-200M

	Tools (mm)	Spindle Speed (rpm)	Feedrate (mm/min)	Cutting Speed (m/min)	Cutting Depth (mm)
Drill	Ø16 HSS	350	35	10	N/A
End mill	Ø20 HSS end drill	400	80	25	10
Tapping	M16 * P2.0	200	400	10	N/A



# ENHANCED AUTOMATIONS

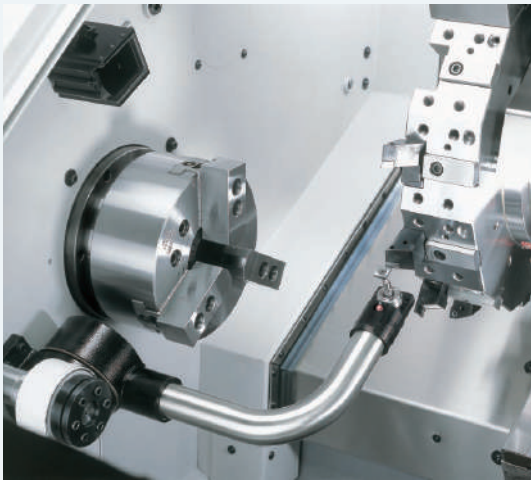

▶ The optional RENISHAW HPMA tool presetter utilizes a motorized arm to lower the tool probe into position. An auto tool check function further increases tool touch-off efficiency.

▶ Hydraulic self-centering steady rests with Z-axis assist base and programmable clamping are available in various sizes.

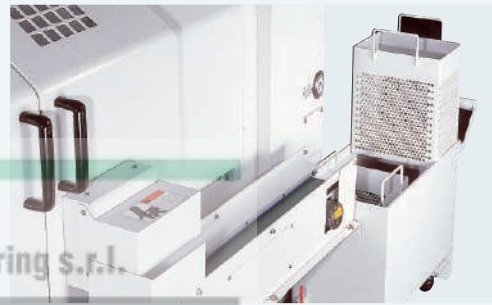
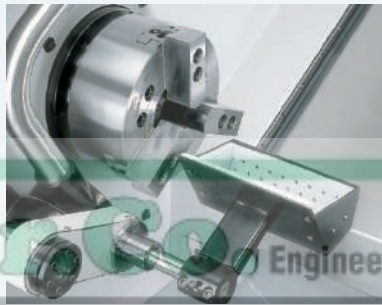
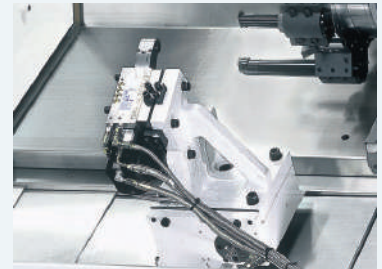

▶ Optional hydraulic parts catchers can be programmed to catch finished parts after cut-off. Part conveyor systems are also available.



▶ Optional bar feeders save manpower and provide greater productivity by automatically feeding bar stock into the machine after each part is completed. BF-65 bar feeding systems feed bars up to 65 mm ( 2.5" ) diameter and BF-80 systems feed bars up to 80 mm ( 3" ).

▶ Available standardized or custom gantry loading / unloading systems provide automatic operation for chucking operations. These flexible systems can be intergraded onto one or more machines to suit a wide range of applications.

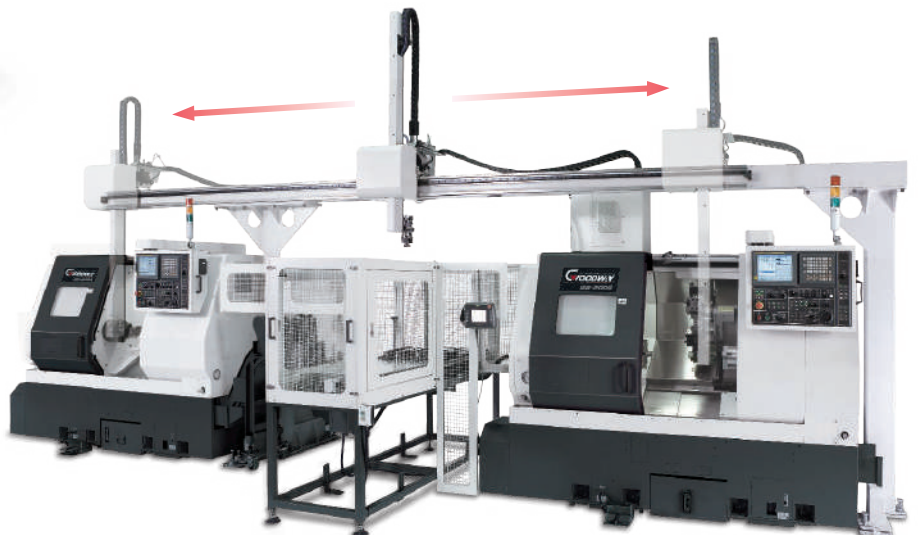

# FEATURES

S: Standard      O: Option  
 -: Not Available    C: Contact GOODWAY

		GS-200	GS-260	GS-280
<b>SPINDLE</b>				
Main spindle motor configuration	Single-speed	S	S	S
	Two-speed	O	O	O
Rigid tapping & spindle orientation		S	S	S
Disk brake for main or sub spindle		O	O	O
Cf-axis & disk brake for main spindle*1		O	O	O
Sub-spindle & 6" hydraulic cylinder*2		O	O	O
Cs-axis & disk brake for sub-spindle*1		O	O	O
<b>WORK HOLDING</b>				
Hydraulic hollow cylinder for chuck	8"	S	-	-
	10"	-	S	S
	10" Big-Bore	-	-	O
Hollow 3-jaws chuck & 1 set soft jaws	6"*2	O	O	O
	8"	O	-	-
	10"	-	O	O
	10" Big-Bore	-	-	O
Hard jaws		O	O	O
Collet chuck		O	O	O
Special work holding chuck		C	C	C
In spindle work stopper		O	O	O
Spindle liner ( guide bushing )		O	O	O
Foot switch for chuck operation	Single	S	S	S
	Double	O	O	O
Programmable base & quill hydraulic tailstock		O	O	O
MT#3 dead center		O	O	O
Foot switch for tailstock operation	Single	O	O	O
	Double	O	O	O
Self-centering hydraulic steady rest		O	O	O
Foot switch for steady rest operation	Single	O	O	O
	Double	O	O	O
	Chuck clamping	O	O	O
Two-stage programmable pressure	Tailstock thrust	O	O	O
<b>TURRET</b>				
12-station turret w/ non-lifting tooling disk		S	S	S
12-station live tooling turret w/ non-lift tooling disk*1		O	O	O
Tool holder & sleeve package		S	S	S
Live tooling tool holders*1		O	O	O
<b>MEASUREMENT</b>				
RENISHAW HPMA tool presetter	Motorized arm	O	O	O
<b>COOLANT</b>				
Coolant pump	3 kg/cm <sup>2</sup>	S	S	S
	5 kg/cm <sup>2</sup>	O	O	O
	10 kg/cm <sup>2</sup>	O	O	O
High-pressure coolant system	20 kg/cm <sup>2</sup>	C	C	C
Roll-out coolant tank		S	S	S
Oil skimmer		O	O	O
Coolant flow switch		O	O	O
Coolant level switch		O	O	O
Coolant intercooler system		O	O	O
<b>CHIP DISPOSAL</b>				
Chip conveyor with auto timer	Right discharge	S	S	S
	Rear discharge	C	C	C
Chip cart with coolant drain		O	O	O
Chuck air blow		O	O	O
Tailstock air blow		O	O	O
Coolant gun		O	O	O
Oil mist collector		O	O	O
<b>AUTOMATIC OPERATION SUPPORT</b>				
Parts catcher		O	O	O
Work piece transport conveyor		O	O	O
Bar feeder		O	O	O
Bar feeder interface		O	O	O
Gantry-type loader / unloader		O	O	O
Auto door		O	O	O
External M-code output	4 sets (8)	O	O	O
	8 sets (16)	O	O	O
<b>SAFETY</b>				
Fully enclosed guarding		S	S	S
Door interlock ( incl. mechanical lock )		S	S	S
Impact resistant viewing window		S	S	S
Tailstock stroke out-end check*3		S	S	S
Chuck cylinder stroke out-end check		S	S	S
Chuck cylinder check valve		S	S	S
Low hydraulic pressure detection switch		S	S	S
Over travel ( soft limit )		S	S	S
Load monitoring function		O	O	O
<b>OTHERS</b>				
Electrical cabinet	Heat exchanger	S	S	S
	A/C cooling system	O	O	O
Complete hydraulic system		S	S	S
Hydraulic oil intercooler system		O	O	O
Advanced auto lubrication system		S	S	S

		Oi-TF	31i
<b>FANUC CONTROL FUNCTIONS</b>			
Display	10.4" color LCD	S	S
Graphic function	Standard	S	S
	Dynamic	O	O
	512K bytes	S	-
Part program storage size	1M bytes	-	S
	2M bytes	O	O
	4M bytes	-	O
	8M bytes	-	O
Registerable programs	400	S	-
	1,000	O	S
	4,000	-	O
	99	-	S
	128	S	-
Tool offset pairs	200	O	O
	400	-	O
	499	-	O
	999	-	O
Servo HRV control	2000	-	O
	HRV 3	S	S
Automatic data backup		S	S
Synchronous / Composite control		O	O
Inch / metric conversion		S	S
Polar coordinate interpolation		S	S
Cylindrical interpolation		S	S
Multiple repetitive cycle		S	S
Rigid tapping		S	S
Unexpected disturbance torque detection function		S	S
Spindle orientation		S	S
Constant surface speed control		S	S
Spindle speed fluctuation detection		S	S
Embedded macro		O	O
Spindle synchronous control		S	S
Background editing		S	S
Tool radius / Tool nose radius compensation		S	S
Multi-language display		S	S
Cs contouring control		S	S
Polygon turning		S	S
Helical interpolation		O	O
Direct drawing dimension programming		S	S
Thread cutting retract		S	S
Variable lead threading		S	S
Multiple repetitive cycle II		S	S
Canned cycles for drilling		S	S
Tool nose radius compensation		S	S
Chamfering / Corner R		S	S
AI contour control I		O	S
Multi part program editing		S	S
Manual handle retrace		O	O
Manual intervention and return		S	O
External data input		S	S
Addition of custom macro		S	S
Increment system C		S	S
Run hour & parts counter		S	S
Auto power-off function		S	S
RS-232 port		S	S
Memory card input / output ( CF + USB )		S	S
Ethernet		S	S

Above standard & optional features also apply to L models.

\*1 For M ( live tooling turret ) models only.

\*2 For S ( sub-spindle ) models only.

\*3 Standard with tailstock option.

# MACHINE SPECIFICATIONS

■ : Metric ■ : Inch

CAPACITY	GS-200 / 200L	GS-260 / 260L	GS-280 / 280L
Max. swing diameter		Ø 650 mm 25.19"	
Swing over saddle		Ø 500 mm 19.68"	
Max. turning diameter*1		Ø 420 mm 16.53"	
Standard turning diameter*1		Ø 205 mm 8.07"	
Max. turning length*1	591 mm / 1,191 mm 23.26" / 46.88"	560 mm / 1,160 mm 22.04" / 45.66"	534 mm / 1,134 mm 21.02" / 44.64"
Max. weight load*2	170 kg 374 lb	230 kg 507 lb	250 kg 551 lb
Chuck size*3	8"	10"	10"*4
Bar capacity	Ø 51 mm 2"	Ø 65 mm 2.55"	Ø 75 mm 2.95" *4
SPINDLE			
Hole through draw tube	Ø 52 mm 2.04"	Ø 65.5 mm 2.57"	Ø 76 mm 2.99"
Hole through spindle	Ø 66 mm 2.59"	Ø 76 mm 2.99"	Ø 90 mm 3.54"
Spindle bearing diameter	Ø 100 mm 3.93"	Ø 120 mm 4.72"	Ø 130 mm 5.11"
Hydraulic cylinder	8"	10"	10"*4
Spindle nose	A2-6	A2-8	A2-8
Motor output ( Cont. )		11 kW 15 HP	
Motor output ( 30 min. )		15 kW 20 HP	
Motor full output speed		750 RPM	
Spindle drive system		Direct Belt Drive	
Spindle drive ratio	4 : 5	2 : 3	7 : 12
Spindle speed range	48 ~ 4,800 RPM	40 ~ 4,000 RPM	35 ~ 3,500 RPM
Spindle full output speed	600 RPM	500 RPM	440 RPM
Spindle torque ( Cont. )	175 Nm 129 lb-ft	210 Nm 155 lb-ft	239 Nm 176 lb-ft
Spindle torque ( 30 min. )	239 Nm 176 lb-ft	287 Nm 212 lb-ft	327 Nm 241 lb-ft
2-SPEED SPINDLE ( OPTIONAL )			
Spindle speed ranges	L	48 ~ 1,200 RPM	40 ~ 1,000 RPM
	H	1,201 ~ 4,800 RPM	1,001 ~ 4,000 RPM
Spindle full output speed	L	400 RPM	335 RPM
	H	600 RPM	500 RPM
Spindle torque ( 15 min. )	L	358 Nm 264 lb-ft	429 Nm 316 lb-ft
Spindle torque ( 30 min. )	H	239 Nm 176 lb-ft	287 Nm 211 lb-ft
			327 Nm 241 lb-ft
Cf-AXIS SPINDLE ( OPTIONAL )			
Cf-axis drive ratio		1 : 120	
Cf-axis rapid		33 RPM	
Cf-axis torque output ( Cont. )		240 Nm 177 lb-ft	
Min. spindle indexing angle		± 0.001°	
Dynamic accuracy		± 0.002°	

Specifications are subject to change without notice.

\*1 Individual models may vary, please see interference drawings.

\*2 Work piece supported by chuck & tailstock.

\*3 Chucks optional.

\*4 Optional 10" Big-bore hydraulic cylinder & chuck provide Ø 78 mm ( 3.07" ) bar capacity.

X & Z AXES	GS-200 / 200L	GS-260 / 260L	GS-280 / 280L
Max. X-axis travel*1	+10 mm, - 200 mm, - 30 mm 0.39", - 7.87", -1.18"		
Max. Z-axis travel*1	+ 30 mm, - 570 mm + 1.18", - 22.44" / + 30 mm, - 1,170 mm + 1.18", - 46.06"		
X / Z axes rapids	20 m/min. 788 IPM / 24 m/min. 945 IPM		
Slide way type	Hardened & Ground Box Ways		
Feed rates	1~ 4,800 mm/min. 1~189 IPM		
X-axis servo motor	AC 2.7 kW 3.6 HP		
Z-axis servo motor	AC 2.7 kW 3.6 HP		
X-axis ball screw Ø / pitch	Ø 32 mm 1.26" / Pitch 6		
Z-axis ball screw Ø / pitch	Ø 36 mm 1.41" / Pitch 8		
X / Z axes thrust ( Cont. )	1,282 kgf 2,826 lbf / 961.8 kgf 2,120 lbf		
<b>TURRET</b>			
Stations	12		
Indexing drive	FANUC AC Servo motor		
Indexing speed	0.2 sec. Adjacent / 0.5 sec. 180 degrees ( Single step )		
Accuracy	Positioning: ± 0.00069°, Repeatability: ± 0.00027°		
O.D. tool shank size	□ 25 mm 1"		
I.D. tool shank size	Up to Ø 40 mm 1-1/2"		
<b>LIVE TOOLING TURRET ( OPTIONAL )</b>			
Stations	12		
Live tooling stations	12 ( Live tooling tools rotate in working position only. )		
Live tooling drive motor	AC 4.5 kW 6 HP		
Live tooling torque	22 Nm 16 lb-ft ( Cont. )		
Indexing drive type	FANUC AC Servo motor		
Index speed	0.2 sec. Adjacent / 0.5 sec. 180 degrees ( Single step )		
O.D. tool shank size	□ 25 mm 1"		
I.D. tool shank size	Up to Ø 40 mm 1-1/2"		
Live tooling shank size	1 ~ 20 mm 0.04" ~ 0.78" ER 32 collets		
Live tooling RPM range	10 ~ 4,000 rpm		
<b>Y-AXIS ( OPTIONAL )</b>			
Max. turning diameter	Ø 340 mm 13.38"		
Max. X-axis travel*1	+ 10 mm, - 160 mm, - 100 mm + 0.39", - 6.29", - 3.93"		
Max. Y-axis travel*1	110 mm = ± 55 mm 4.33" = ± 2.16"		
X / Y axes rapids	20 m/min. 788 IPM / 10 m/min. 394 IPM		
Slide way type	Hardened & Ground Box Ways		
Feed rates	1 ~ 4,800 mm/min. 1 ~ 189 IPM		
X-axis servo motor	AC 2.7 kW 3.6 HP		
Y-axis servo motor	AC 2.7 kW 3.6 HP		
X-axis ball screw Ø / pitch	Ø 36 mm 1.41" / Pitch 8		
Y-axis ball screw Ø / pitch	Ø 32 mm 1.26" / Pitch 6		
X / Y axes thrust ( Cont. )	961.8 kgf 2,120 lbf / 1,282 kgf 2,826 lbf		

Specifications are subject to change without notice.

\*1 Individual models may vary, please see interference drawings.

# MACHINE SPECIFICATIONS

■ : Metric ■ : Inch

TAILSTOCK ( OPTIONAL )	GS-200 / 200L	GS-260 / 260L	GS-280 / 280L
Quill center taper	MT#3 ( Built-in spindle type, Live quill )		
Quill diameter / travel	Ø 85 mm 3.34" / 120 mm 4.72"		
Tailstock base travel*1	470 mm 18.50" / 1,100 mm 43.3"		
Programmable quill / base	Yes / Yes		
Programmable base type	Positioned by Z-axis carriage through user-friendly macro programming		
SUB-SPINDEL ( OPTIONAL )			
Standard turning diameter	Ø 152 mm 5.98"		
Chuck size*2	6"		
Hole through spindle	Ø 46 mm 1.81"		
Spindle bearing diameter	Ø 80 mm 3.14"		
Hydraulic cylinder	6"		
Spindle nose	A2-5		
Motor output ( Cont. )	5.5 kW 7.5 HP		
Motor output ( 30 min. )	7.5 kW 10 HP		
Motor full output speed	1,500 rpm		
Spindle drive system	Built-in motor ( Integrated Motor )		
Spindle drive ratio	1 : 1		
Spindle speed range	60 ~ 6,000 rpm		
Spindle full output speed	1,500 rpm		
Spindle torque ( Cont. )	35 Nm 26 lb-ft		
Spindle torque ( 30 min. )	48 Nm 35 lb-ft		
Zs-axis travel*1	+ 30 mm, - 570 mm + 1.18", - 22.44" / + 30 mm, - 1,020 mm + 1.18", - 40.15"		
Zs-axis rapid	24 m/min. 945 IPM		
Slide way type	Hardened & Ground Box Ways		
Zs-axis servo motor	AC 1.8 kW 2.4 HP		
Zs-axis ball screw Ø / pitch	Ø 36 mm 1.41" / Pitch 10		
Zs-axis thrust ( Cont. )	769 kgf 1,695 lbf		
MAIN SPINDEL PARTS CATCHER ( OPTIONAL )			
Max. part diameter	Ø 60 mm 2.36"		
Max. part length	180 mm 7.08"		
Max. part weight	4 kg 8.8 lb		

Specifications are subject to change without notice.

\*1 Individual models may vary, please see interference drawings.

\*2 Chuck optional.

■ : Metric ■ : Inch

GENERAL	GS-200 / 200L	GS-260 / 260L	GS-280 / 280L
NC controller	FANUC Oi-TF		
Voltage / Power requirement	AC 200 / 220 +10% to -15% 3 phase / 26 kVA		
Hydraulic tank capacity	30 L 8 gal		
Coolant tank capacity	200 L 52 gal		
Coolant pump	0.5 kW ( 3/4 HP , 60 Hz ) rated at 4.2 bar 60 PSI		
Machine weight	4,800 kg 10,580 lb / 5,600 kg 12,350 lb		
Machine weight ( MS models )	5,000 kg 11,030 lb / 5,800 kg 12,790 lb		
Dimensions L x W x H*1	Machine: 2,670 / 3,500 x 1,900 x 1,900 mm 106" / 138" x 75" x 75" Machine w / Y-axis: 2,670 / 3,500 x 2,040 x 2,260 mm 106" / 138" x 81" x 89"		

Specifications are subject to change without notice.

\*1 Individual models may vary, please see drawings below.

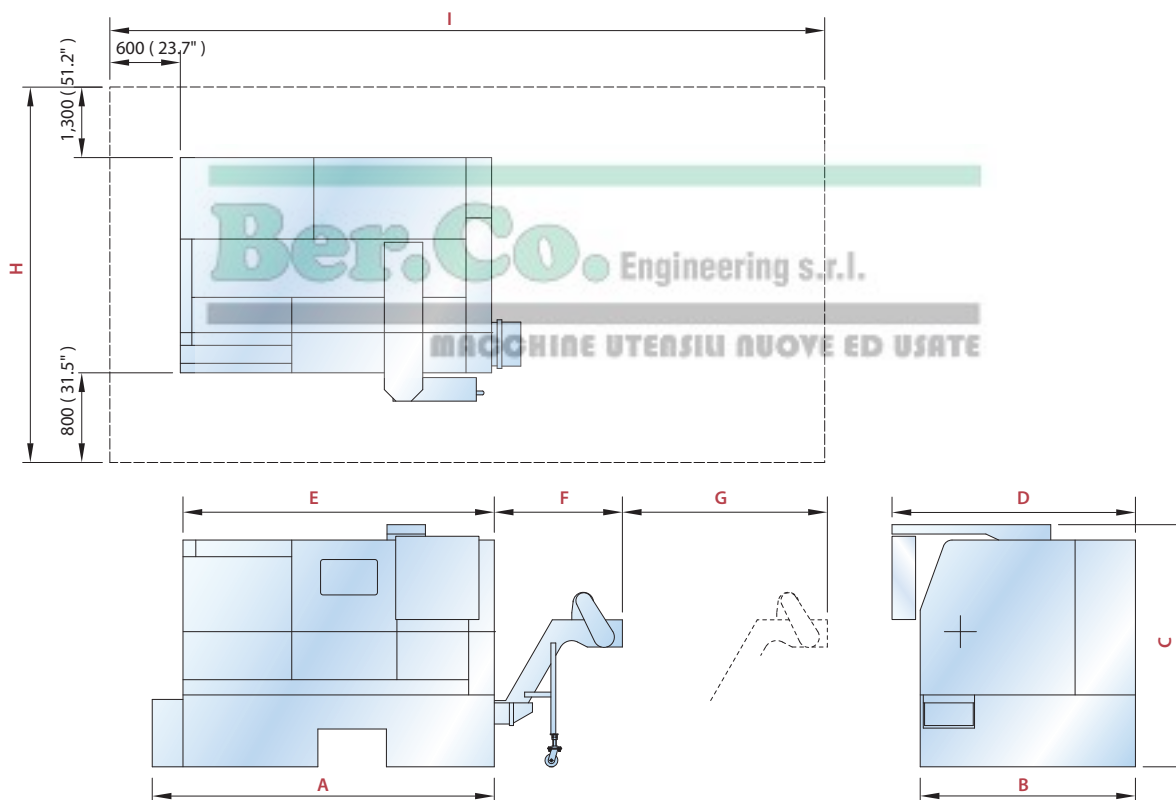

MODELS	A	B	C	D	E	F	G	H	I
GS-200 / 260 / 280	2,670 (105.2")	1,840 (72.5")	1,890 (74.5")	1,955 (77.0")	2,430 (95.7")	1,000 (39.4")	1,900 (74.9")	3,940 (155.2")	5,930 (233.5")
GS-200L / 260L / 280L	3,500 (137.8")	1,760 (69.3")	1,900 (74.9")	1,900 (74.9")	3,500 (137.8")	1,050 (41.4")	2,450 (96.5")	3,860 (152.0")	7,600 (299.3")
GS-200 / 260 / 280 (Y-axis)	2,670 (105.2")	1,810 (71.3")	2,260 (89.0")	1,920 (75.6")	2,430 (95.7")	1,000 (39.4")	1,900 (74.9")	3,910 (153.4")	5,930 (233.5")
GS-200L / 260L / 280L (Y-axis)	3,500 (137.8")	1,840 (72.5")	2,260 (89.0")	2,040 (80.4")	3,500 (137.8")	1,050 (41.4")	2,450 (96.5")	3,940 (155.2")	7,600 (299.3")

Unit : mm ( inch )



**Ber.Co.** Engineering s.r.l.

MACCHINE UTENSILI NUOVE ED USATE



GOODWAYCNC.com

## GOODWAY MACHINE CORP.

### HEADQUARTERS

No.13, 5<sup>th</sup> Road,  
Taichung Industrial Park,  
Taichung City, 407, Taiwan  
E-mail : [goodway@goodwaycnc.com](mailto:goodway@goodwaycnc.com)

### CENTRAL TAIWAN SCIENCE PARK BRANCH

No. 38, Keyuan Road,  
Central Taiwan Science Park.Taichung,  
Taichung City, 407, Taiwan  
TEL : + 886-4-2463-6000  
FAX : + 886-4-2463-9600

### GOODWAY MACHINE ( WUJIANG ) CO.,LTD

No. 4888, East Lake Taihu Avenue, Wujiang  
Economic and Technological Development Zone,  
Jiangsu, China  
Sales Hotline : + 86-512-8286-8068  
Service Hotline : + 86-512-8286-8066  
FAX : + 86-512-8286-8620  
E-mail : [goodway@goodwaycnc.cn](mailto:goodway@goodwaycnc.cn)