

# SW-II SERIES

MULTI-TASKING SWISS TURNING CENTERS



THE ULTIMATE MACHINING POWER  
**WOODWAY**

# MULTI-TASKING SWISS TURNING CENTERS

On the basis of innovative mechanical structure, plentiful tooling system and flexible hybrid guide bush design, SW-II serial can achieve unprecedented rigidity and productivity. SW-II with 7-axis ( X / Y / Z / XB / ZB / B / Y<sub>2</sub> ) control ability. Not only complicated work piece can be overcome but also with short cycle time that can satisfy your different processing requirement nowadays and future.



( SW-20II model shown with optional G.LINC intelligent control system )

## B-AXIS MACHINING CAPABILITY

- ▶ B-axis function can machine not only specific angle hole but also can do 4-axis simultaneous profile processing ( Smooth TCP, G43.4 / G43.5 ). Any complicated part can be overcome.
- ▶ B-axis movement control can be edited freely, it means B-axis can be changed any angle\*<sup>1</sup> continuously when machine not stop, processing efficiency increased substantially.

\*1 please refer to page 4



**0.001°**

Min. indexing

**135°**

Max. swivel angle\*<sup>1</sup>

**3 + 3**

(front) (rear)

Max. tool numbers

### B-axis tool holder vs Angle adjustable tool holder

TOOL HOLDER	B-AXIS	ANGLE ADJUSTABLE
Angle convert	Edited freely	Manual
Indexing	Program	Manual + measuring device





( Optional B & Y<sub>2</sub> axes of SW-20II 7-axis tooling system )

## Evolution Structure Rigidity

- ▶ High rigidity one-piece bed structure, MEEHANITE casting with high tension and thermal hydraulics design is able to decrease thermal deforming , this can keep stable processing accuracy even machine keep working for long time.
- ▶ Compare to last generation design, SW-II machine base is more solid, structure rigid increase 30%.
- ▶ To enhance back processing cutting rigidity, SW-II series we design the rear-end tool holder component fixed on the base ( scrapping procedure on contact facing ) ; machine base would absorb the vibration during processing to avoid resonance when main and sub spindle cutting at the same time, to make sure perfect processing accuracy.

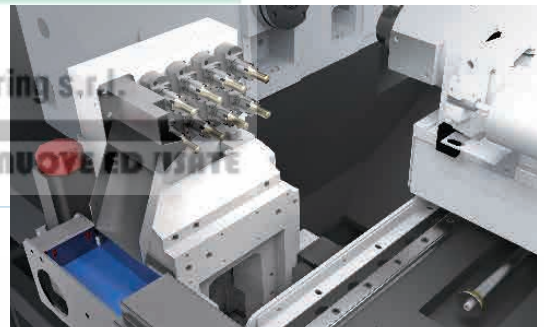
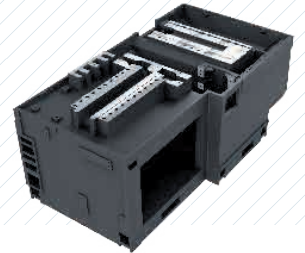

## Y<sub>2</sub>-AXIS MACHINING CAPABILITY

- ▶ With optional Y<sub>2</sub>-axis function can proceed eccentric drilling / tapping on back of part and drilling / tapping on radial direction.
- ▶ Backworking tooling system with 8 live tools<sup>\*2</sup>. Therefore, the rear-end live tool can do the back processing which originally processed by counter face live tools. Processing procedure can be optimization and shorten processing cycle time.

\*2 T26 and T27 must with live tools ( SW-20II )

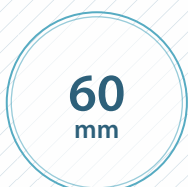

Max. Travel  
SW-20II

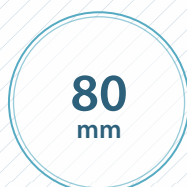

Max. Travel  
SW-32II



Max.  
tool numbers

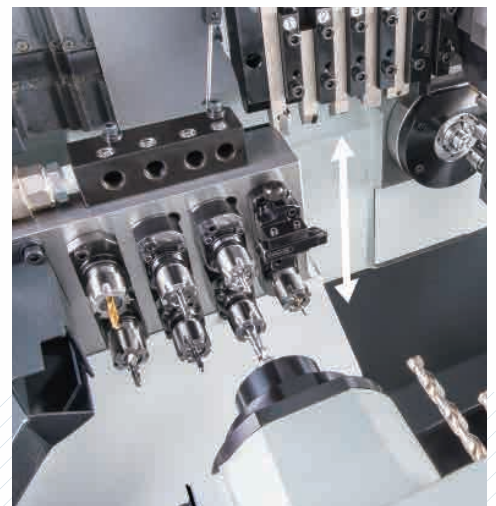

# FLEXIBLE TOOLING SYSTEM



Sufficient tooling post and flexible tooling system which maximum 41 tools\*<sup>1</sup> (include 23 live tools) is available. All multiple tasks, such as the front surface of workpiece, rear eccentric drilling, tapping and milling operations can be completed in one machine.

\*<sup>1</sup> 6-axis tooling system with Y<sub>2</sub>-axis

## Axis system

Feed axis	5-axis	6-axis	7-axis
X \ Y \ Z \ XB \ ZB axes	S	S	S
B-axis	-	S	S
Y <sub>2</sub> -axis	-	-	S

S : Standard - : Not Available

## 5-axis tooling system

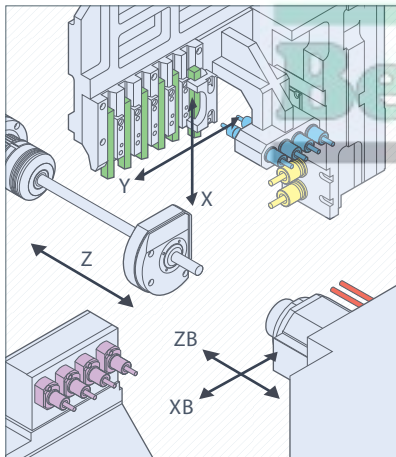

### SW-20II

- O.D. tool x 6
- I.D. tool x 8
- Cross live tool x 5
- Rear-end live tool x 4
- Deep hole drilling x 2

### SW-32II

- O.D. tool x 6
- I.D. tool x 10
- Cross live tool x 5
- Rear-end live tool x 4
- Deep hole drilling x 2

## 6-axis tooling system

B-axis

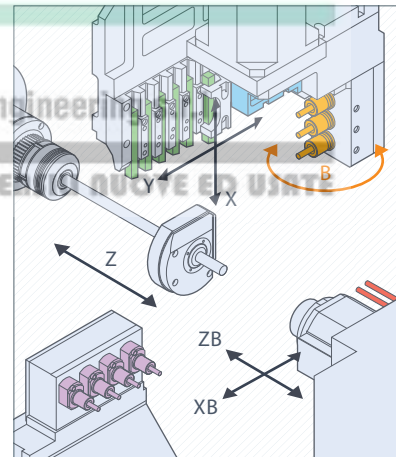

### SW-20II

- O.D. tool x 6
- live tool x 2
- B-axis live tool x 6
- Rear-end live tool x 4
- Deep hole drilling x 2

### SW-32II

- O.D. tool x 5
- live tool x 2
- B-axis live tool x 6
- Rear-end live tool x 4
- Deep hole drilling x 2

## 6-axis tooling system

Y<sub>2</sub>-axis

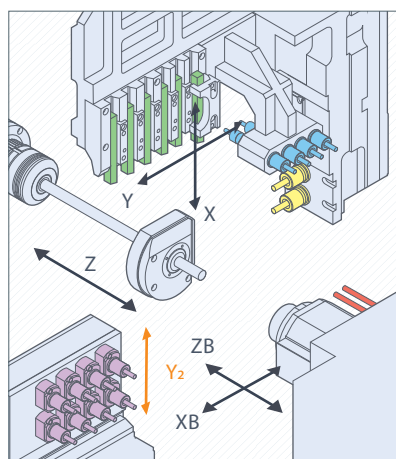

### SW-20II

- O.D. tool x 6
- I.D. tool x 8
- Cross live tool x 5
- Rear-end live tool x 8
- Deep hole drilling x 2

### SW-32II

- O.D. tool x 6
- I.D. tool x 10
- Cross live tool x 5
- Rear-end live tool x 8
- Deep hole drilling x 2

## 7-axis tooling system

B-axis

Y<sub>2</sub>-axis

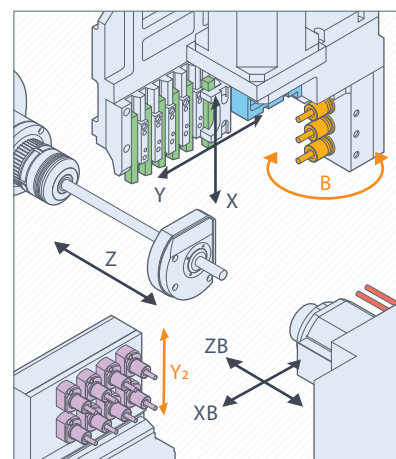

### SW-20II

- O.D. tool x 6
- live tool x 2
- B-axis live tool x 6
- Rear-end live tool x 8
- Deep hole drilling x 2

### SW-32II

- O.D. tool x 5
- live tool x 2
- B-axis live tool x 6
- Rear-end live tool x 8
- Deep hole drilling x 2



## Flexible Live Tooling System ( without B-axis )



**Standard** Cross live tool x 5

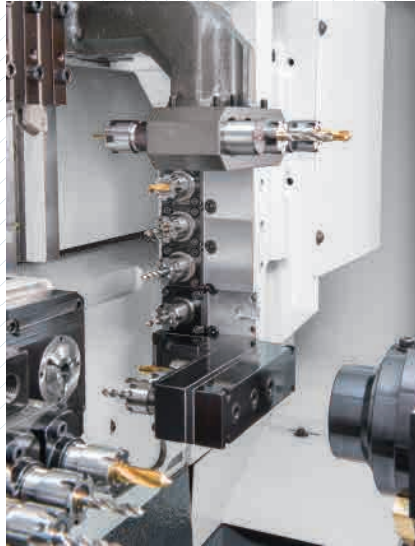

**Expansion** Cross live tool x 4



**Expansion** Cross live tool x 3

Front-end live tool x 3

Front-end live tool x 5

Rear-end live tool x 2

**Ber.Co.** Engineering s.r.l.

## Flexible Live Tooling System ( with B-axis )

MAGCHINE UTENSILI NUOVE ED USATE

B-axis live tool system is not only for 6 live tooling ( 3 each for front and rear side ) and adjacent tool ( T31 & T32 ) but also available with different type of live tool holders. With this flexible tool system which can meet different type of work requirements.

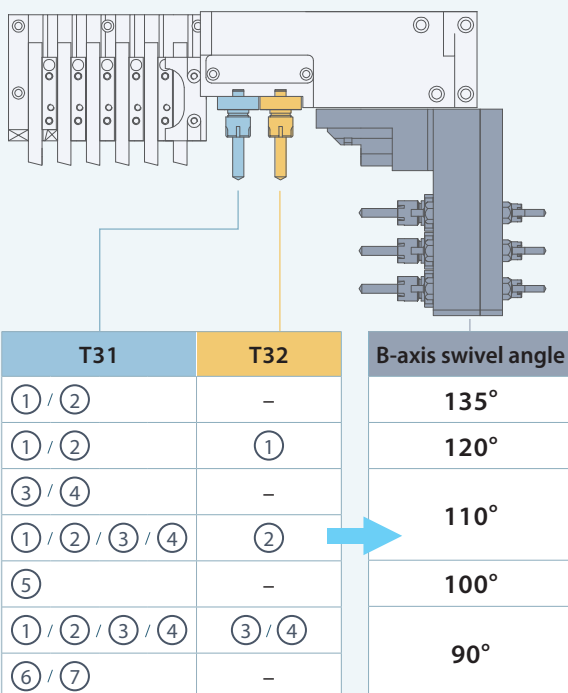

- : Not able to mount tools

- ① ER16 cross live tool  
LC-ZDE0 ( SW-20II )  
ER20 cross live tool  
LL-ZBB0 ( SW-32II )
- ② ER16 cross live tool ( extended type )  
LC-ZDH0 ( SW-20II )
- ③ ER16 2-spindle front-end live tool  
LC-ZDB0 ( SW-20II )  
LL-ZBC0 ( ER20 ) ( SW-32II )  
ER16 counter face 2-spindle live tool  
LC-ZDL0 ( SW-20II )  
LL-ZBL0 ( SW-32II )  
( Spindle ER16 / Sub-spindle ER11 )
- ④ ER16 3-spindle front-end tool  
LC-ZDC0 ( SW-20II )  
LL-ZDC1 ( SW-32II )  
ER16 3-spindle front-end live tool  
LC-ZDG0 ( SW-20II )  
LL-ZBD0 ( SW-32II )  
ER16 counter face 3-spindle live tool  
LL-ZBK0 ( SW-32II )  
( Spindle ER16 / Sub-spindle ER11 )
- ⑤ Polygon turning holder  
LC-3094 ( SW-20II )  
LC-3094A ( SW-20II )  
LL-3094 ( SW-32II )
- ⑥ Slotting holder  
LC-30U0 ( SW-20II )  
LL-3098 ( SW-32II )
- ⑦ Thread whirling holder  
LC-3095 ( SW-20II )  
LL-3095 ( SW-32II )

# ULTIMATE MACHINING POWER

## High Performance Spindle System

- ▶ High precision built-in motor design can greatly reduce the spindle vibration to ensure the super high machining accuracy and extend spindle life time.
- ▶ Servo motor drive spindle head and hydraulic brake system design can speed up acceleration and deceleration movement and positioning precisely.
- ▶ With large-span linear guide way design of Z-axis for headstock, motion Z-axis is stable and no hysteresis.

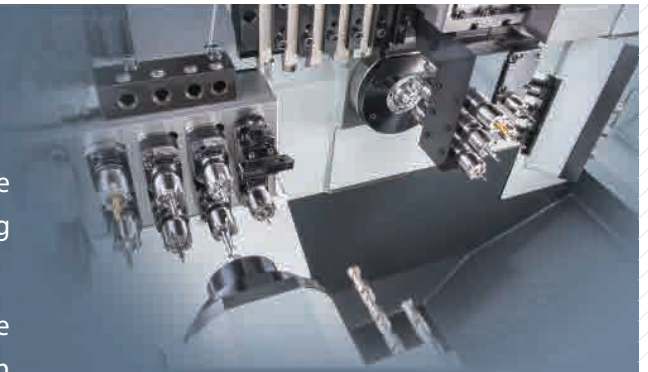

Rotary hydraulic cylinder can provide greater clamping force ( option )

### Spindle output

### Sub-spindle output

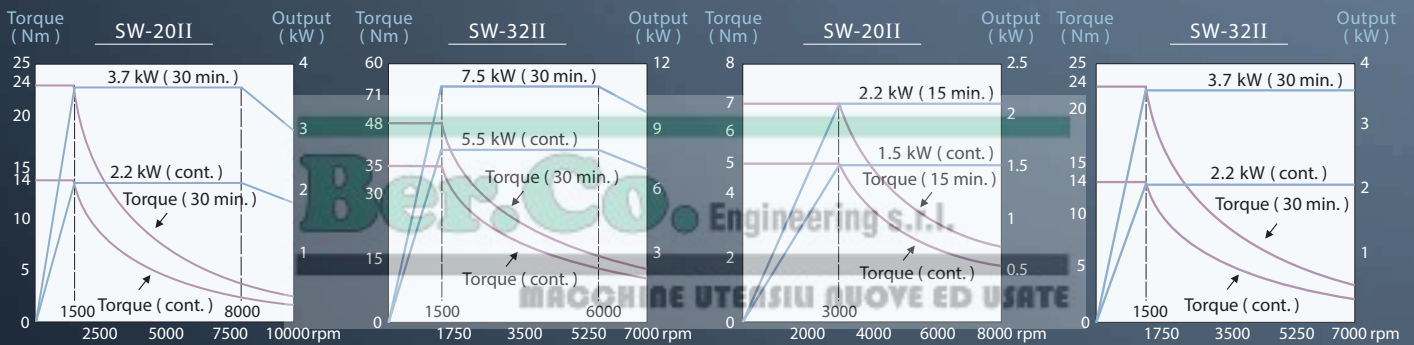

## Hybrid Guide Bush

The hybrid guide bush design ( bush or bushless are all available ) which can be exchanged easily on SW-II series, multiple function in one machine. A single operator can mount or dismount guide bush kit in a short time.

- ▶ Use guide bush to avoid overhang and support long bar which can keep the rigidity to ensure the machining accuracy and stability. Guide bush machining is especially suitable for long-bar work-piece requirement.
- ▶ Switch to bushless type, no precise grinding bar is required and can directly use for machining. Due to no space requirement between guide bush and chuck, remain bar obviously reduced. Effectively lower down the cost of production.

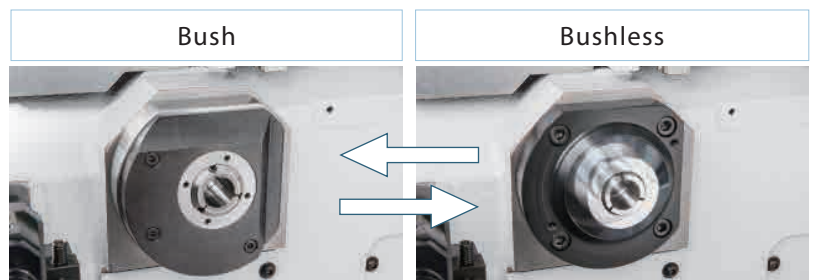

### Remaining bar length

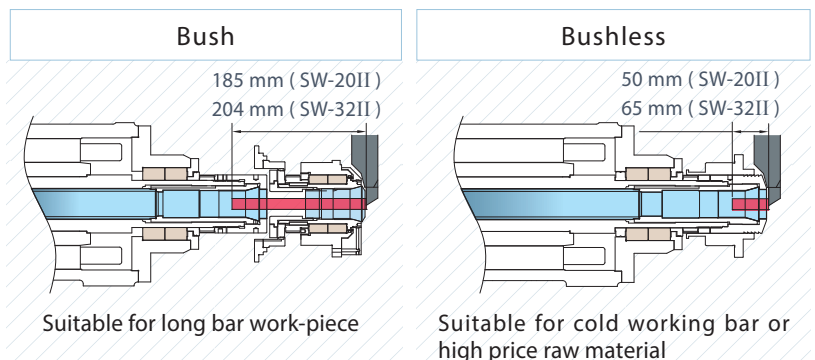





## Back-end Machining Capability

High speed and low vibration design built-in sub-spindle ( option for SW-20II ) can meet high accuracy machining requirement. Besides, with the built-in air blow and parts ejector system, parts can be auto unloading without manpower.

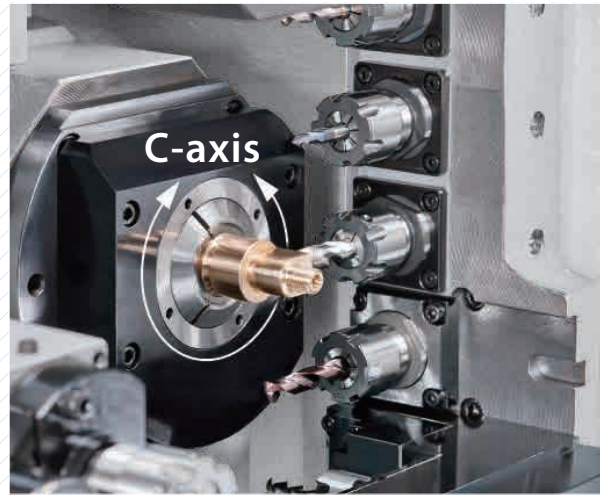

## C-axis Machining Capability

Both main and sub-spindle are equipped with C-axis function include 0.001° resolution. SW-II also possess turning-milling complex machining ability include with cylindrical and contour machining of polar coordinate interpolation.

### Front off-center drilling & tapping

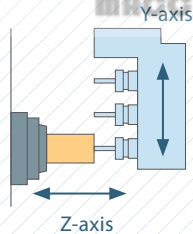
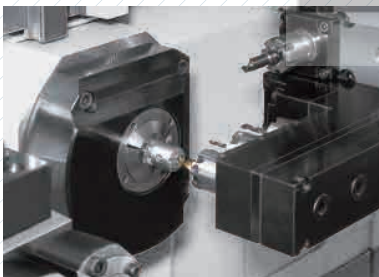

### Front / Rear simultaneous drilling & tapping

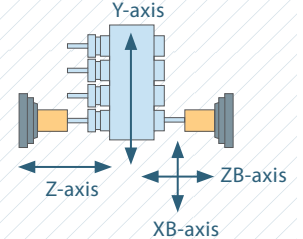
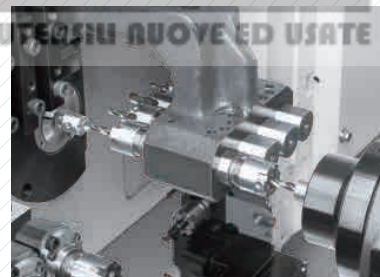

### Rear off-center drilling & tapping

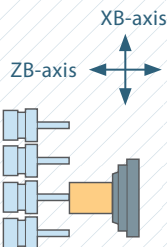
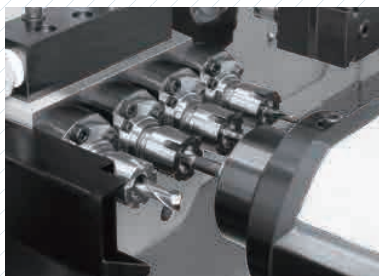

### Front / Rear simultaneous drilling & tapping (w/ B-axis model)

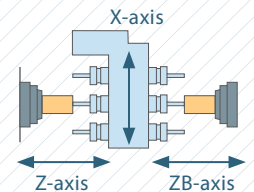

### Main & Sub-spindle simultaneous machining

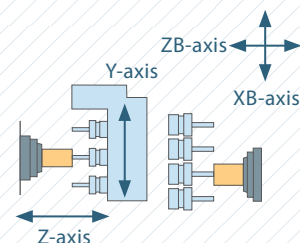
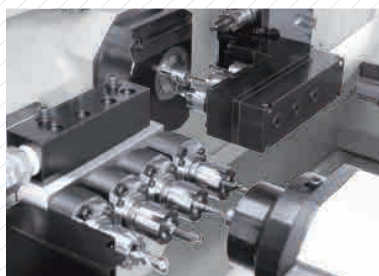

### Cross machining

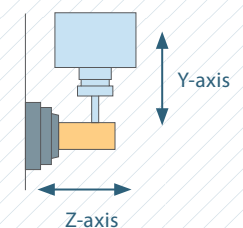
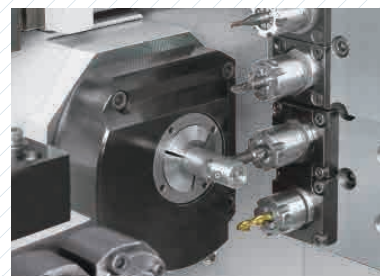

# MACHINING VARIATIONS

To confront increasingly complex workpiece and mass production with high speed requirement, the traditional machining might be very time consuming and it cannot overcome the requirement. To select GOODWAY high performance live tooling holder can solve above mentioned difficulty.



## Thread whirling

By the multi-blade structure on the Thread Whirling Unit and the pneumatic chip cooling technology, the efficiency of thread whirling and the accuracy on the surface can be increased dramatically. It is particular suitable for machining requirement of bone screw and miniature ballscrew.



## Polygon turning

By using the speed ratio of spindle and driven tool holders to provide rapid polygon turning ability.



## Hobbing

To possess high rigidity, low interference, convenience on tool changing and excellent surface accuracy can be provided while rapid cutting.

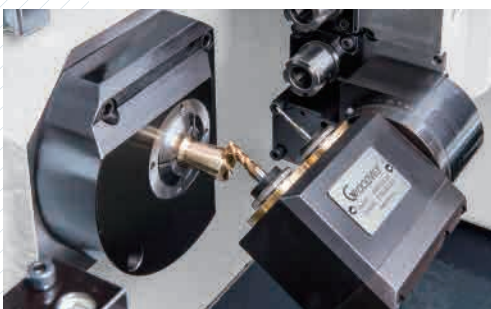

## Angle head driven tools

To satisfy different angle hole machining, you can have 5° division positioning manually between angle adjusting rang -90°~ +90°.



## Slotting

Using slotting driven tools to provide high efficiency and extend tool life compare to normal end milling tools.





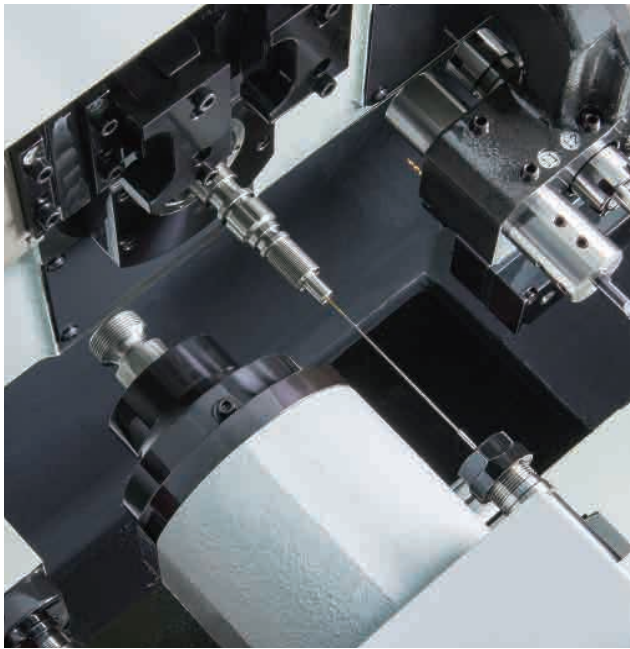

## Deep hole drilling

The sub spindle on SW-II model can equip with 2 pcs of deep hole drill. When machine with guide bush and deep-hole drill work together with high pressure coolant system, it can provide the best drilling performance. The maximum drilling depth for SW-20II and SW-32II will be 184 mm and 280 mm<sup>\*1</sup>.

<sup>\*1</sup> This drilling depth is only for bush type machine and the drilling depth will be different according to the machining requirement. Please contact GOODWAY for further information.

Tool diameter : Ø 1.32 mm

Tool length : 150 mm

High-pressure coolant system : 140 Bar

Material : SUS303



**ALLCOOL**  
SYSTEMS

# HIGH PRESSURE COOLANT SYSTEM

- High quality gear pump.
- Use disposable filter bag, it's efficient, time saving, easy and safe.
- Pressure adjustment conform with ergonomics.
- With tri-color signal light tower, can warning the status.
- With emergency stop switch.
- Built-in filter warning and stop system.
- Built-in the pressure is too low or too high alarm.

**140 Bar**  
**(2,000 PSI)**

Max. Pressure



**i** SMART  
INVERTER

### Ethernet fast connection

### Automatic Variable Pressure Control ( AVP control )

- Use NC program to control output pressure.
- Maintain stable pressure in different diameter of tools.
- Save 40% electric power in average.

Model	SP 1000	SP 2000	SE 500	SE 1000	SE 1500
Coolant Type	Oil		Oil / Water		
Max. Pressure <sup>*1</sup>	70 Bar ( 1,000 PSI ) <sup>*1</sup>	140 Bar ( 2,000 PSI ) <sup>*1</sup>	35 Bar ( 500 PSI )	70 Bar ( 1,000 PSI )	100 Bar ( 1,500 PSI )
Max. Flow Rate	12 LPM ( 3 GPM ) <sup>*1</sup>	19 LPM ( 5 GPM ) <sup>*1</sup>	25 LPM ( 6.6 GPM )	25 LPM ( 6.6 GPM )	24 LPM ( 6.3 GPM )
Motor Output	2.2 kW ( 3 HP )	5.5 kW ( 7.5 HP )	2.2 kW ( 3 HP )	5.5 kW ( 7.5 HP )	7.5 kW ( 10 HP )
Filtration System	5μ		5μ		
Option	<b>i</b> / <b>u</b>		<b>i</b>		

<sup>\*1</sup> Was tested with temperature : 40°C / viscosity : 46 CST oil in 220V, 60Hz.

Pressure output would change according to the oil temperature, voltage and frequency.

Specifications are subject to change without notice.

**i** Smart Inverter ( Ethernet + AVP control )    **u** Concealed Design ( Under bar feeder available )

# OCR OSCILLATING CHIP REMOVAL ( opt. )

- ▶ OCR oscillating cutting is the turning technology by using the oscillating function to cut fine chips.
- ▶ Cutting chips breaks with Air-cut oscillating function.

**No mechanical failure occurred due to entangled chips which enhances machine effectiveness.**

## General Turning

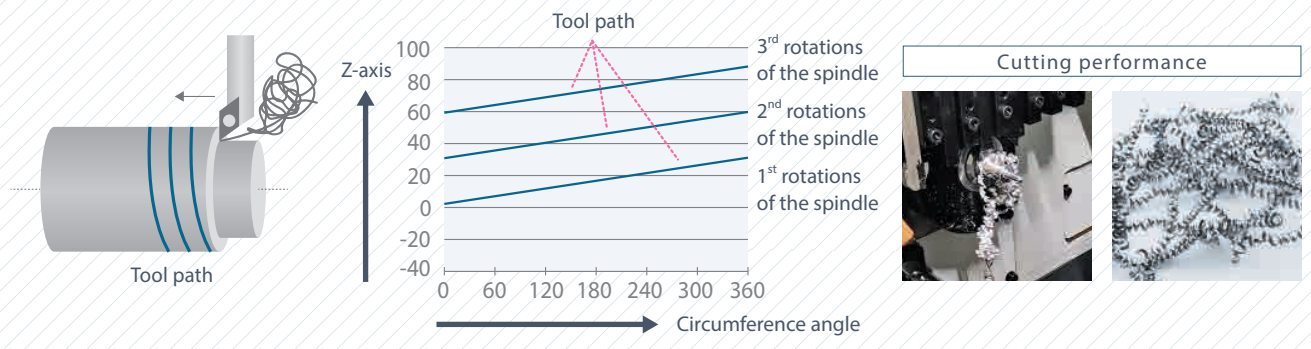

## Oscillating Turning

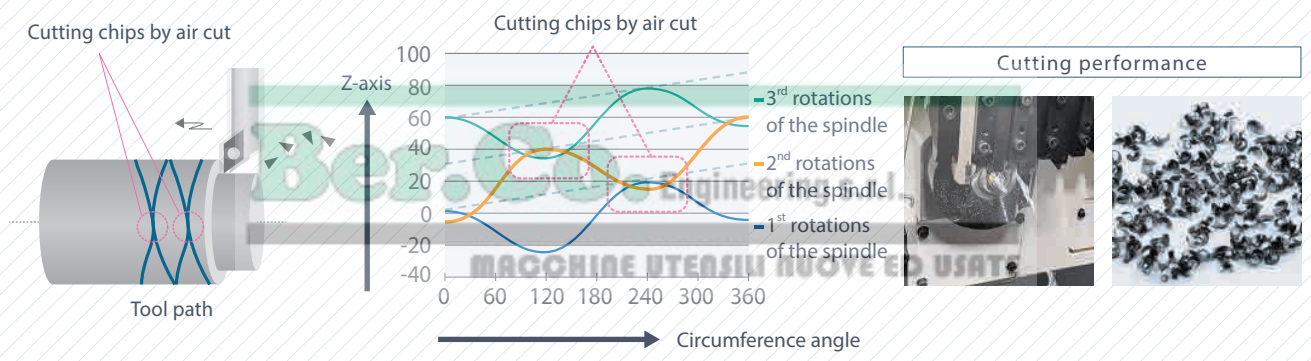

# AIR BAG

Standard with air bag for maximum protection and also minimum the damage when machine crash which can save the cost of repair machines and production lost because of machine broken.

**Retract tools within 0.009 second**

**Equipped with air bag**

Machine crash → EMG mode

- Servo motor reverse rotary within 0.009 second
- Machine stop

**Not equipped with air bag**

After machine crashed, axes continue feeding, machine structure might get damaged seriously.



# GLINC 350 INTELLIGENT OPERATING SYSTEM (opt.)

## Makes Your Machine Smarter

- ▶ Advanced Hardware
- ▶ Outstanding Operability
- ▶ Streamlined Programming
- ▶ High Security and Shortened Machining Setting
- ▶ Reliable Continuous Operation
- ▶ Shortened Troubleshooting Time
- ▶ Improved Utilization Rate
- ▶ 3D cutting simulation preview



## Significant Production Efficiency



## Comprehensive Functions

Programming	Setting	Test-Run	Actual Production	Daily Used
<ul style="list-style-type: none"> <li>Dynamic graphic display</li> <li>Program management</li> <li>Friendly programing environment</li> <li>Programming auxiliary</li> <li>Manual Guide <i>i</i></li> <li>Embedded E-manual</li> </ul>	<ul style="list-style-type: none"> <li>3D advance tool path and cutting simulation</li> </ul>	<ul style="list-style-type: none"> <li>Tool load monitor</li> <li>Program check</li> <li>Smart balance etection</li> <li>3D Real-time cutting simulation and interference check</li> </ul>	<ul style="list-style-type: none"> <li>Tool load monitor</li> <li>3D Real-time cutting simulation and interference check</li> <li>Load monitoring</li> </ul>	<ul style="list-style-type: none"> <li>Safety signal viewer</li> <li>Fast alarm check productivity</li> <li>Productivity management</li> <li>Twin operation system switch</li> <li>Maintenance management</li> <li>NFC apply authority management and record</li> </ul>



# STANDARD & OPTIONAL FEATURES

Prevent tool interference



Manual Handle Retrace

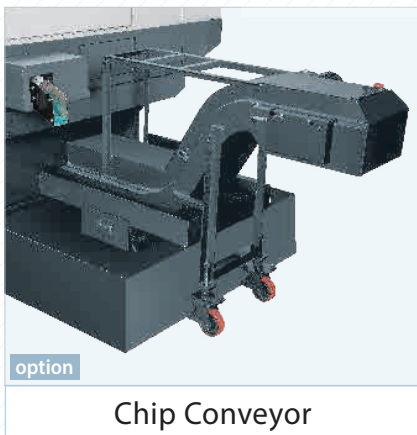
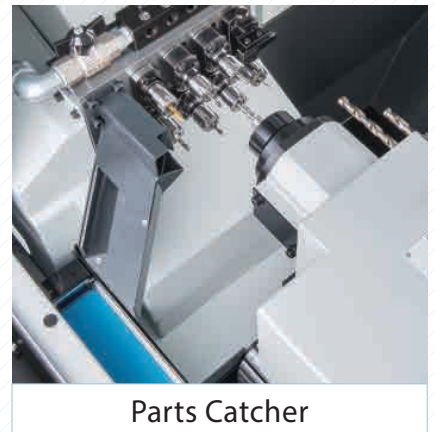



S : Standard    O : Option  
 - : Not Available    C : Contact Goodway

		SW-2011	SW-3211
<b>SPINDLE</b>			
Main spindle motor configuration		S	S
Rigid tapping		S	S
C-axis		S	S
Spindle brake		S	S
<b>WORK HOLDING</b>			
Spindle hardness collect		O	O
Spindle tungsten collect		O	O
Sub-spindle hardness collect		O	O
Sub-spindle tungsten collect		O	O
Special work holding chuck		O	O
<b>GUIDE BUSH</b>			
Stationary guide bush		O	O
Revolving guide bush		S	S
Rotary magic guide bush		O	O
Tungsten guide bush		O	O
<b>COOLANT</b>			
Coolant pump		S	S
High-pressure coolant system	5.0 MPA	O	O
	7.0 MPA	O	O
	10 MPA	O	O
	14 MPA	O	O
Roll-out coolant tank		S	S
Coolant flow switch		S	S
Coolant level switch		S	S
<b>CHIP DISPOSAL</b>			
Chip conveyor		O	O
Chip cart with coolant drain		O	O
Oil mist collector		O	O
<b>LIVE TOOLING</b>			
ER16 cross live tool		O	O
ER16 3-spindle front-end live tool		O	O
ER16 2-spindle front-end live tool		O	O
ER16 slotting holder		O	O
ER16 3-spindle angle head driven tools ( 0 ~ 360° )		O	O
ER16 rear-end live tool		O	O
ER20 cross live tool		-	O
ER20 3-spindle front-end live tool		-	O
ER20 2-spindle front-end live tool		-	O
ER20 2-spindle angle head driven tools ( 0 ~ 360° )		-	O
ER20 rear-end live tool		-	O
Slotting holder		-	O
Thread whirling holder		O	O
Polygon turning holder		O	O
<b>AUTOMATIC OPERATION SUPPORT</b>			
Bar feeder		O	O
Bar feeder interface		S	S
Parts catcher		S	S
Parts conveyor		S	S
Long parts ejector		O	O
<b>SAFETY</b>			
Fully enclosed guarding		S	S
Door interlock ( incl. Mechanical lock )		S	S
Impact resistant viewing window		S	S
Low hydraulic pressure detection switch		S	S
Over travel ( soft limit )		S	S
Load monitoring function		S	S
Cut-off detector		S	S
<b>OTHERS</b>			
Electrical cabinet	A/C cooling system	O	O
	Heat exchanger	S	S
Hydraulic system		S	S
Pneumatic system		S	S
Advanced auto lubrication system		S	S

		O <sub>i</sub> -TF	31i
<b>FANUC CONTROL FUNCTIONS</b>			
Display	10.4" color LCD	S	S
Graphic function	Standard	S	S
	Dynamic	O	O
Part program storage size	512 K bytes	S	-
	1 M bytes	O	S
	2 M bytes	-	O
	4 M bytes	-	O
O <sub>i</sub> -TF : each path	8 M bytes	-	O
	31i : total	400	S
Registerable programs	500	O	-
	O <sub>i</sub> -TF : each path	1,000	-
31i : total	4,000	-	O
	99	-	S
Tool offset pairs	128	S	-
	200	O	O
O <sub>i</sub> -TF : each path	400	-	O
	31i : total	499	-
Servo HRV control	999	-	O
	2000	-	O
Automatic data backup	HRV 3	S	S
		-	S
Synchronous / Composite control		S	S
Superimposed Control		S	S
Inch / metric conversion		S	S
Polar coordinate interpolation		S	S
Cylindrical interpolation		S	S
Multiple repetitive cycle		S	S
Rigid tapping		S	S
Unexpected disturbance torque detection function		S	S
Spindle orientation		S	S
Constant surface speed control		S	S
Spindle speed fluctuation detection		S	S
Embedded macro		S	S
Spindle synchronous control		S	S
Background editing		S	S
Tool radius / Tool nose radius compensation		S	S
Multi-language display		S	S
Cs contour control		S	S
Polygon turning		S	S
Helical interpolation		S	S
Direct drawing dimension programming		S	S
Thread cutting retract		S	S
Variable lead threading		S	S
Multiple repetitive cycle II		S	S
Canned cycles for drilling		S	S
Synchronous / Composite / Superimposed control by program command		S	S
Tool nose radius compensation		S	S
Chamfering / Corner R		S	S
AI contour control I		O	S
Multi part program editing		S	S
Manual handle retrace		S	S
Manual intervention and return		S	S
External data input		S	S
Addition of custom macro		S	S
Increment system C		S	S
Run hour & parts counter		S	S
Auto power-off function		S	S
RS-232 port		S	S
Memory card input / output ( CF + USB )		S	S
Ethernet		S	S

Specifications are subject to change without notice.

# DIMENSIONS

SW-20II 5-axis tooling system

Bush

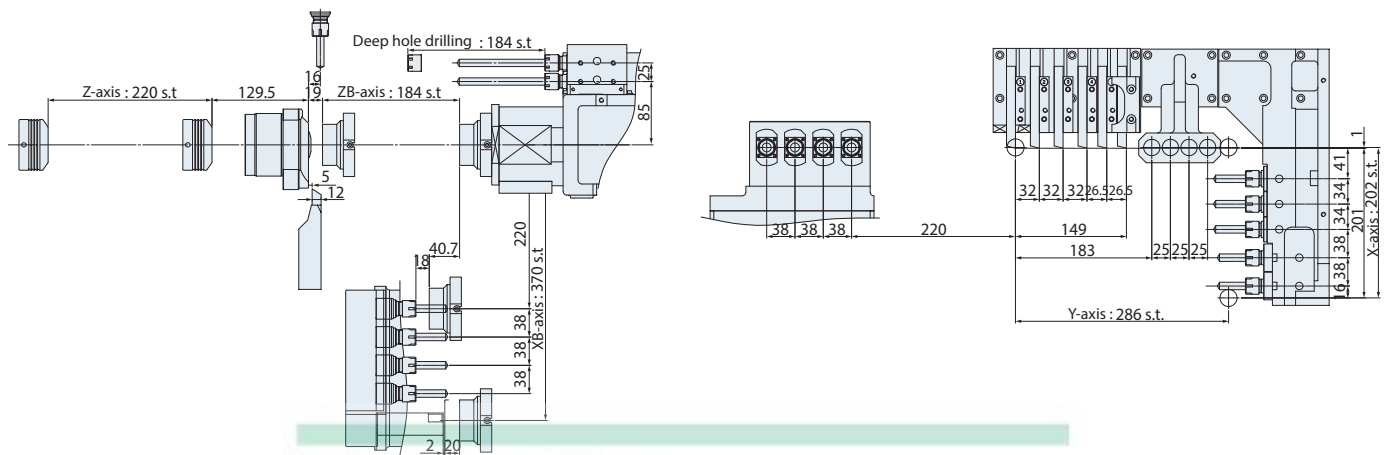

**Ber.Co.** Engineering s.r.l.  
 MAGCHINE UTENSILI NUOVE ED USATE

Bushless

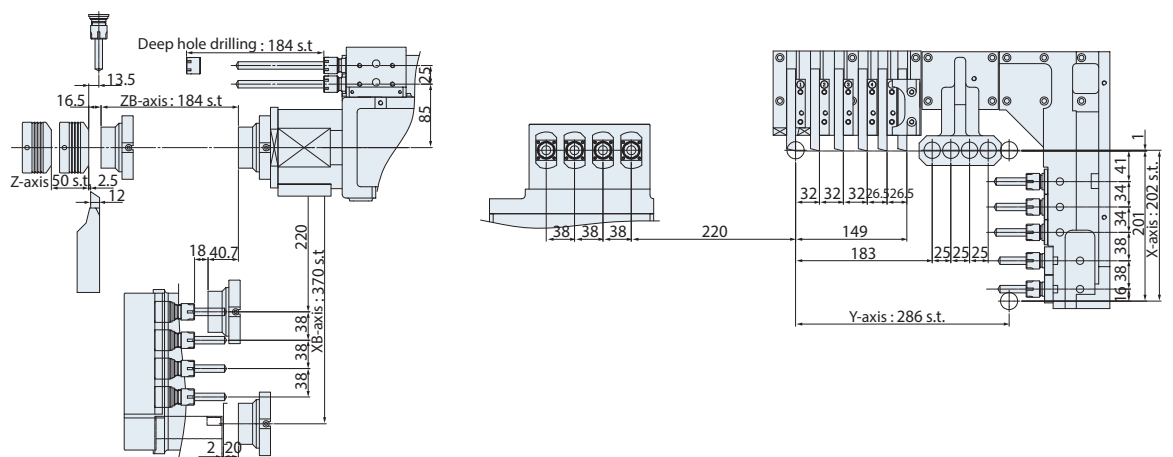

unit : mm



Bush

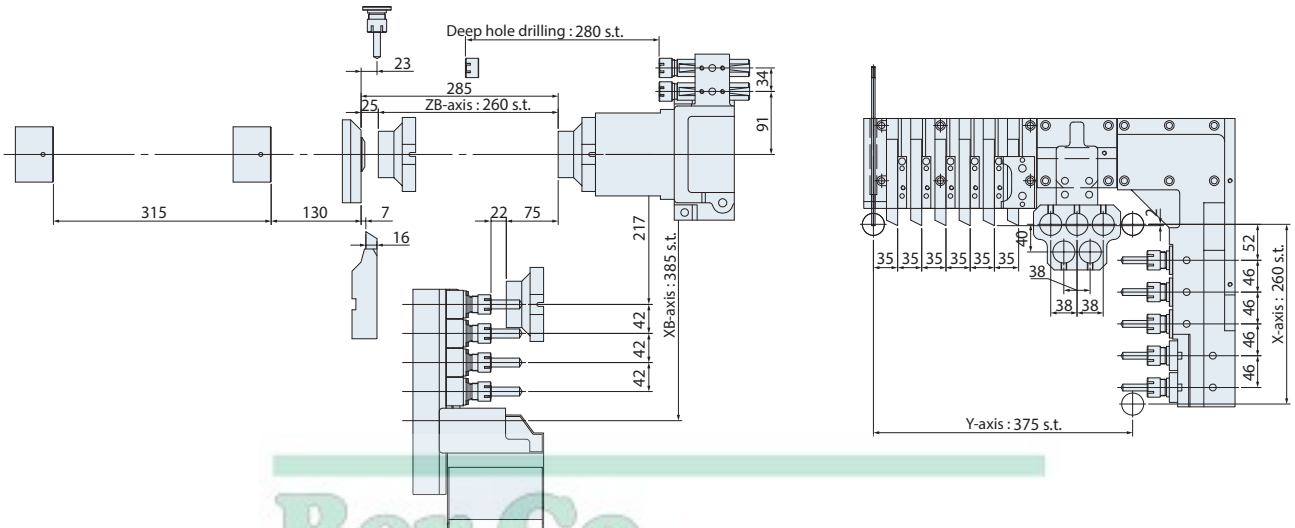

Bushless

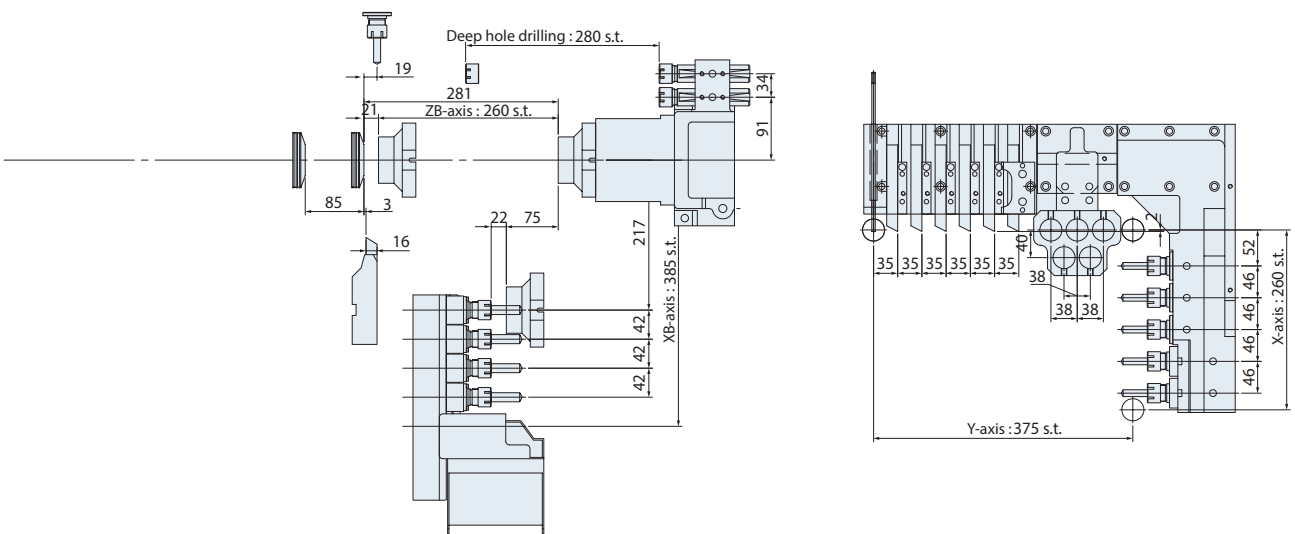

unit : mm

# DIMENSIONS

SW-20II 7-axis tooling system

Bush

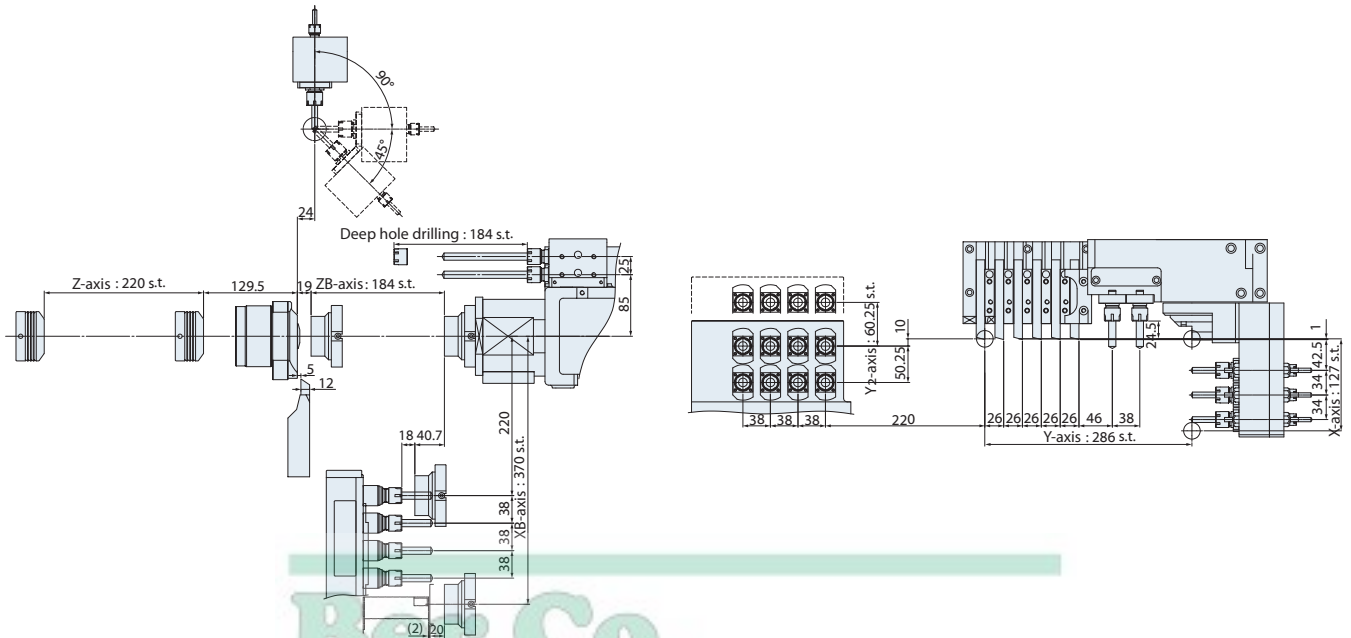

**Bep.Co.** Engineering s.r.l.  
 MAGCHINE UTENSILI NUOVE ED USATE

Bushless

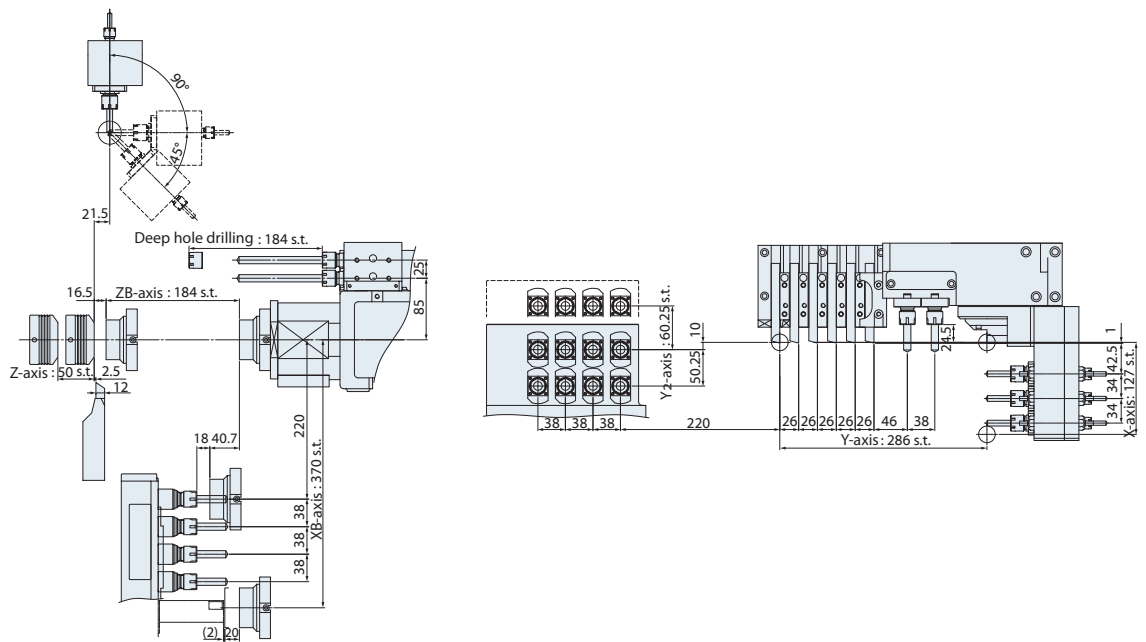

unit : mm

Bush

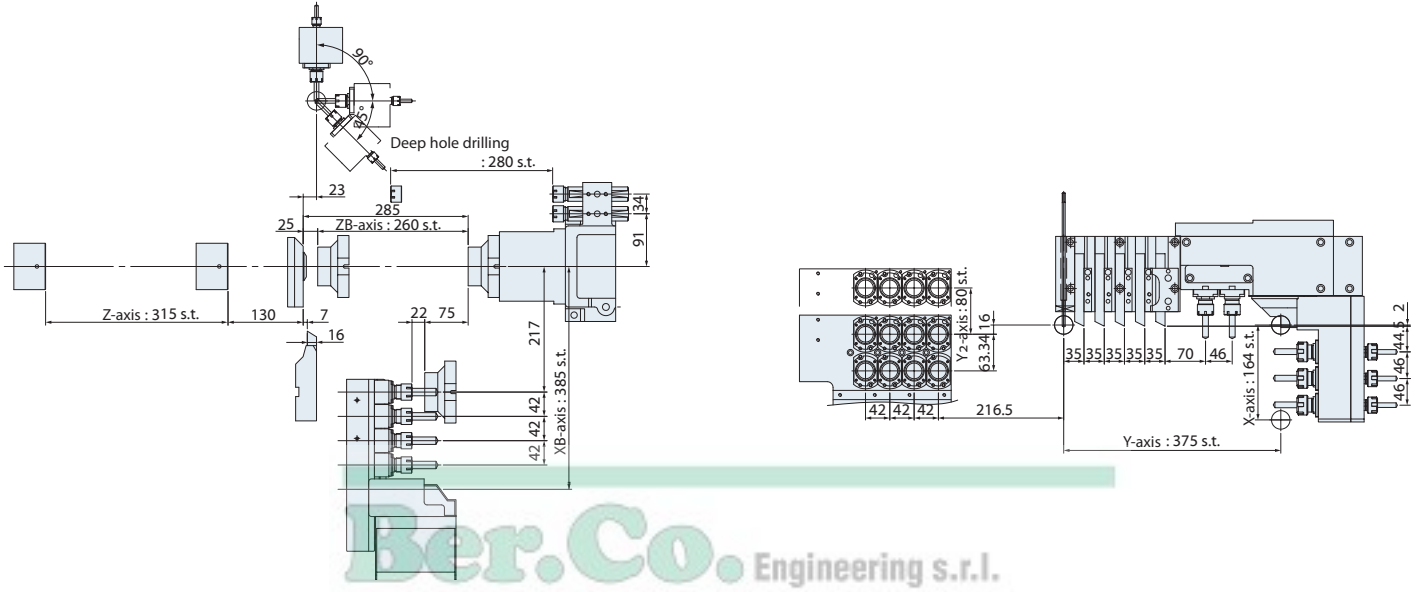

**Ber.Co.** Engineering s.r.l.

MACCHINE UTENSILI NUOVE ED USATE

Bushless

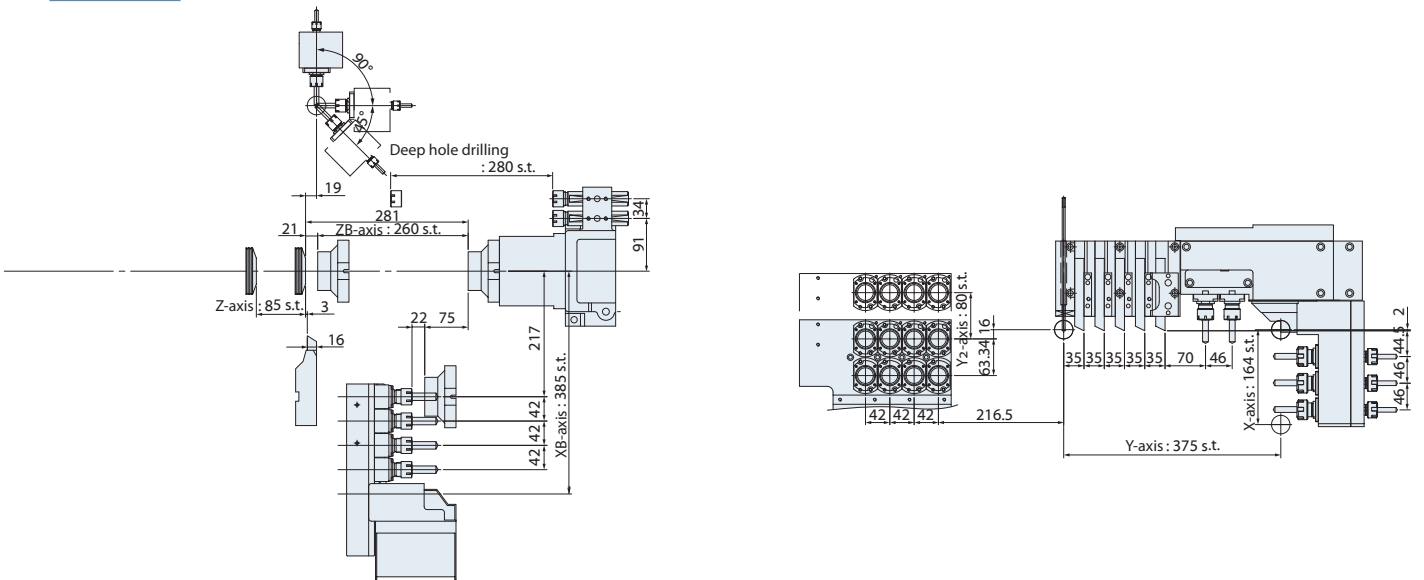

unit : mm



# MACHINE SPECIFICATIONS

■ : Metric ■ : Inch

CAPACITY		SW-20II	SW-32II
Max. machining diameter		Ø 20 mm 0.78"	Ø 32 mm 1.25"
Max. turning length per chuck	bush	220 mm 8.66"	315 mm 12.4"
	bushless	50 mm 1.96"	85 mm 3.34"
SPINDLE			
Max. spindle speed		10,000 rpm	7,000 rpm
Motor output ( cont. / 15 min. )		2.2 / 3.7 kW 3 / 5 HP	5.5 / 7.5 kW 7.3 / 10 HP
Min. indexing increment		0.001°	0.001°
SUB SPINDLE			
Max. spindle speed		8,000 rpm	
Motor output ( cont. / 15 min. )		1.5 / 2.2 kW 2 / 3 HP	
Min. indexing increment		0.001°	
BUILT-IN SUB SPINDLE ( Option for SW-20II, Standard for SW-32II )			
Max. spindle speed		10,000 rpm	7,000 rpm
Motor output ( cont. / 15 min. )		2.2 / 3.7 kW 3 / 5 HP	2.2 / 3.7 kW 3 / 5 HP
Min. indexing increment		0.001°	0.001°
FEED SYSTEM			
X / Y / Z / XB / ZB axes rapids		30 m/min. 1,181 IPM	30 m/min. 1,181 IPM
Slide way type		Linear guide ways	Linear guide ways
TOOLING SYSTEM			
O.D. tools	Number of tools	6	6
	Shank size	<input type="checkbox"/> 12 mm 1/2"	<input type="checkbox"/> 16 mm 5/8"
I.D. tools	Number of tools	4	5
	Sleeve size	ER16	ER20
	Max. drilling capacity	Ø 10 mm 0.39"	Ø 13 mm 0.51"
	Max. tapping capacity	M8 x P1.25	M12 x P1.75
Cross live tools	Number of tools	5 ~10	5 ~10
	Max. live tooling speed	8,000 rpm	6,000 rpm
	Tooling drive motor	1.2 kW 1.6 HP	1.4 kW 1.8 HP
	Sleeve size	ER16	ER20
	Max. drilling capacity	Ø 8 mm 0.31"	Ø 10 mm 0.39"
	Max. tapping capacity	M6 x P1.0	M8 x P1.25
	Max. end mill capacity	Ø 10 mm 0.39"	Ø 13 mm 0.51"
B-AXIS TOOLING SYSTEM ( OPT. )			
O.D. tools	Number of tools	6	5
	Shank size	<input type="checkbox"/> 12 mm 1/2"	<input type="checkbox"/> 16 mm 5/8"
Cross live tools	Number of tools	2	2
	Sleeve size	ER16	ER20
B-axis live tools	Number of tools	Front : 3 / Rear : 3	Front : 3 / Rear : 3
	Sleeve size	Front : ER16 / Rear : ER11	Front : ER20 / Rear : ER16
	Tooling drive motor	2.2 kW 3 HP	2.2 kW 3 HP
	Max. live tooling speed	8,000 rpm	6,000 rpm
	Swivel angle	Max. 135° ( please refer to page 4 )	

Per.Co. Engineering s.r.l.  
MACCHINE UTENSILI NUOVE ED USATE

■ : Metric ■ : Inch

BACKWORKING TOOLING SYSTEM		SW-20II	SW-32II
Rear-end machining capability	Max. chucking diameter	Ø 20 mm 0.78"	Ø 32 mm 1.25"
	Max. length for front ejection	80 mm 3.14"	130 mm 5.11"
	Max. parts projection length	30 mm 1.18"	50 mm 1.96"
Rear-end tools	Number of tools	4	4
	Max. live tooling speed	8,000 rpm	5,000 rpm
	Tooling drive motor	0.4 kW 0.53 HP	0.75 kW 1 HP
	Sleeve size	ER16	ER20
	Max. drilling capacity ( I.D. tools )	Ø 8 mm 0.31"	Ø 13 mm 0.51"
	Max. drilling capacity ( live tools )	Ø 5 mm 0.19"	Ø 6 mm 0.23"
	Max. tapping capacity ( I.D. tools )	M8 x P1.25	M10 x P1.5
	Max. tapping capacity ( live tools )	M4 x P0.7	M5 x P0.8

Y <sub>2</sub> -AXIS BACKWORKING TOOLING SYSTEM ( OPT. )		
Number of tools	8	8
Y <sub>2</sub> -axis travel	60 mm 2.36"	80 mm 3.14"
Y <sub>2</sub> -axis rapid	20 m/min. 787 IPM	20 m/min. 787 IPM

GENERAL		
NC controller	FANUC 31i	FANUC 31i
Spindle center height	1,060 mm 41.7"	1,060 mm 41.7"
Coolant tank capacity	260 L 68 gal	425 L 112 gal
Machine dimensions ( L x W x H )	2,710 x 1,500 x 1,750 mm 107" x 60" x 69"	2,915 x 1,700 x 1,795 mm 115" x 67" x 71"
Machine weight	2,850 kg 6,300 lb	3,400 kg 7,500 lb

Specifications are subject to change without notice.

## MACHINE DIMENSIONS

SW-20II

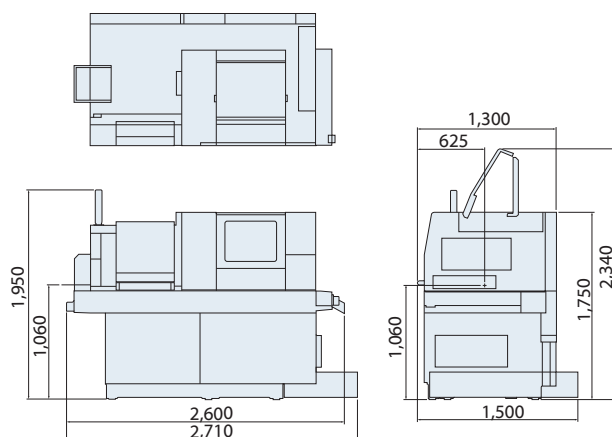

SW-32II

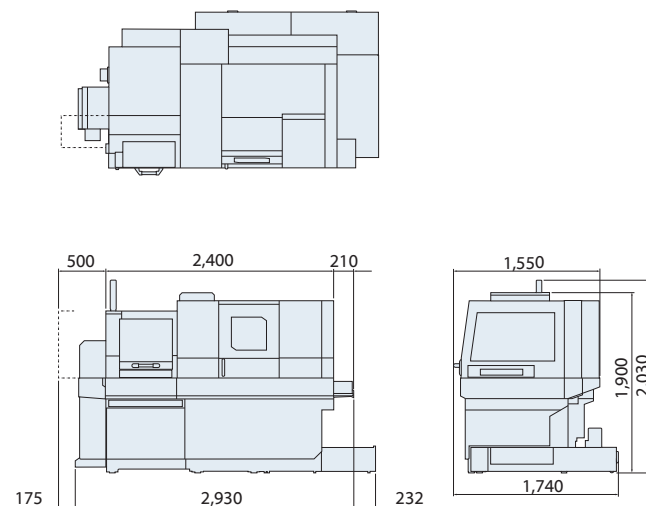

unit : mm



**Ber.Co.** Engineering s.r.l.

MACCHINE UTENSILI NUOVE ED USATE

**GOODWAY MACHINE CORP.**



[GOODWAYCNC.com](http://GOODWAYCNC.com)

Official distributor for Benelux



**THOLITEC**

Jan Doustraat 37  
1689 XK Zwaag (NH)  
The Netherlands

Tel. +31(0)85 0022937  
[info@tholitec.nl](mailto:info@tholitec.nl)  
[www.tholitec.nl](http://www.tholitec.nl)