

# GS-6000L SERIES

MAXIMUM PERFORMANCE CNC TURNING CENTERS

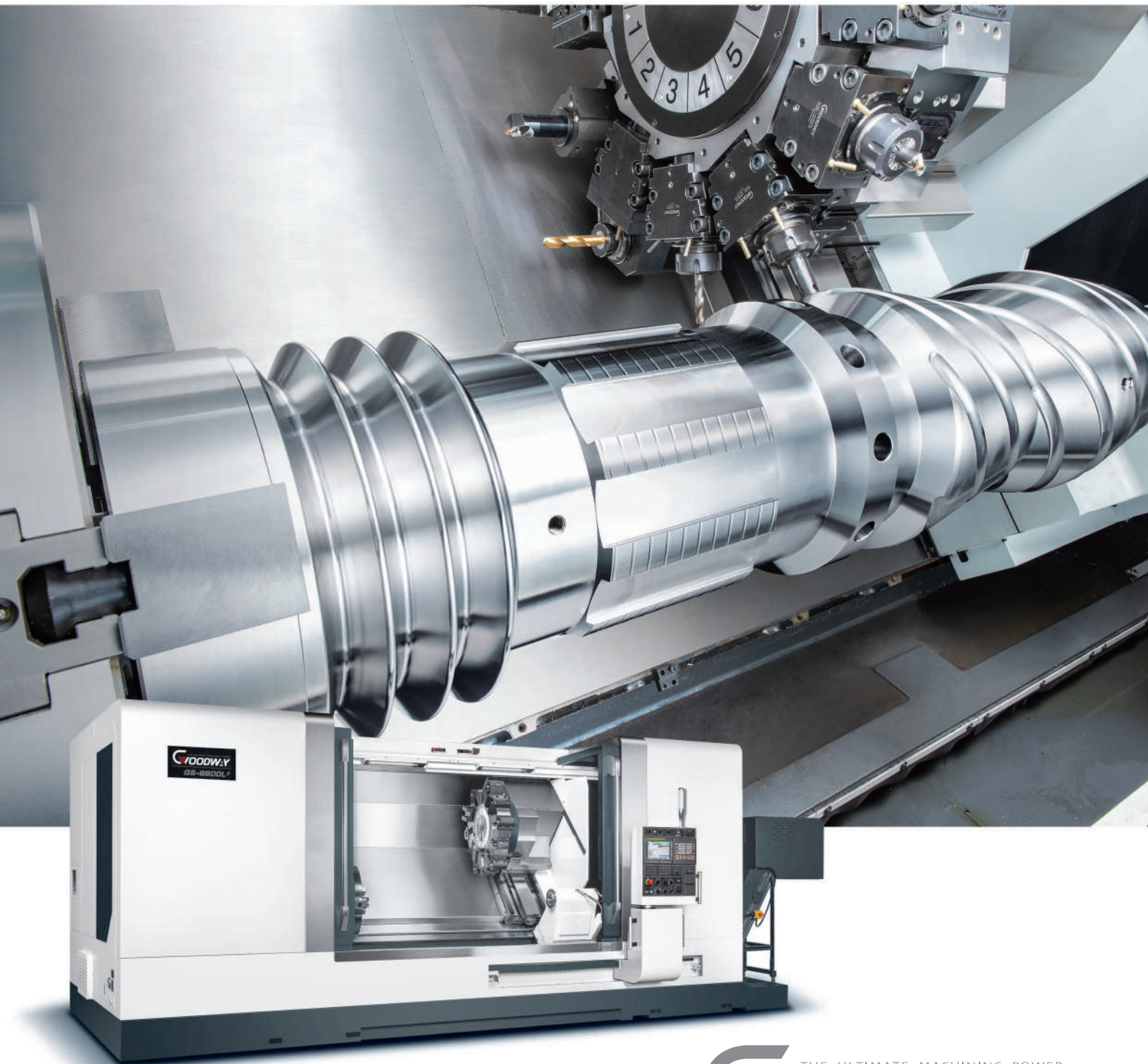

THE ULTIMATE MACHINING POWER  
**WOODWAY**

# MAXIMUM PERFORMANCE CNC TURNING CENTERS

With leading technologies and high quality components, the GS-6000L series maximum performance turning center combines a super rigidity box way bed with super large diameter servo indexing turret and 2-step gear spindle structure that provides great horse power, high speed indexing, and heavy-duty cutting capabilities. The GS-6000L series is available with optional L<sup>3</sup> model, with up to 3,300 mm turning length and "M" model, with live tooling turret and C-axis, which enables higher cutting flexibility and multi-tasking power to meet most of today and tomorrow's turning applications demands.

- ▶ 3 bed lengths and 3 spindle sizes offer a total of 9 basic model configurations.

		GS-6000L SERIES	GS-6600L SERIES		GS-6800L SERIES
Chuck Size		Ø 15" (18")	Ø 20"	Ø 22"*1	Ø 24"*1
Bar Capacity		Ø 115 mm ( 4.52" )	Ø 180 mm ( 7.08" )	Ø 205 mm ( 8.07" )	Ø 260 mm ( 10.24" )
Turning Length	1,020 mm ( 40.1" )	GS-6000L / LM	GS-6600L / LM		GS-6800L / LM
	2,020 mm ( 79.5" )	GS-6000L <sup>2</sup> / L <sup>2</sup> M	GS-6600L <sup>2</sup> / L <sup>2</sup> M		GS-6800L <sup>2</sup> / L <sup>2</sup> M
	3,300 mm ( 129.9" )	GS-6000L <sup>3</sup> / L <sup>3</sup> M	GS-6600L <sup>3</sup> / L <sup>3</sup> M		GS-6800L <sup>3</sup> / L <sup>3</sup> M

"M" model for optional live tooling turret function. \*1 Optional air chuck



- ▶ The first thing you'll notice inside the door of the GS-6000L series is the massive turret, which boasts a turret disk over 750 mm in diameter. Blazing fast indexing times of 1 seconds from station to station and 2 second for stations at 180 degrees are achieved with servo indexing technology.
- ▶ Under the covers, you'll find a 45 degrees true slant bed with super wide box ways, and an enormous 2-speed head stock driven by a 37 kW ( 30 min. ) FANUC motor.
- ▶ Axes rapids are 20 m/min. on X and 24 m/min. on Z, which are 50 ~ 100 % faster than the competitors.
- ▶ Utilizing the most advanced industrial design, the fully enclosed protection covers isolates cutting chips and coolant inside the machine.





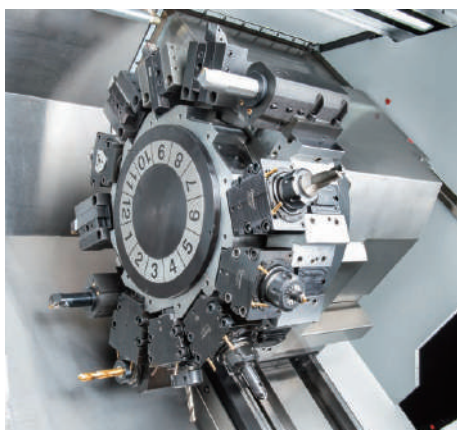

### Live tooling turret

---

- Available live tooling and C-axis capabilities in the GS-6000L series allow the machine to perform multiple tasks on a work-piece, such as turning, milling, drilling, and tapping. This decreases manpower and cycle time as well as eliminates the accuracy lost when a part is moved from machine to machine. ( More on P9. )

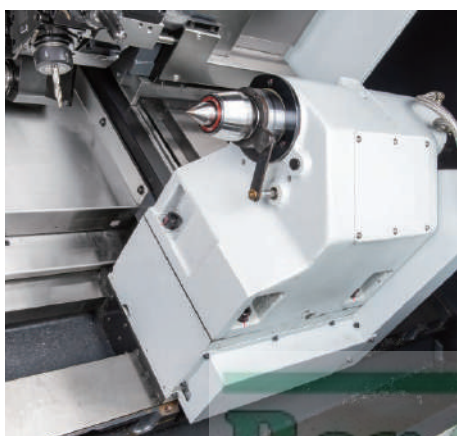

### Tailstock

---

- Positioning of the programmable base tailstock has been simplified through use of custom software interface. The Z-axis carriage automatically locks on to the base of the tailstock and drags it to the desired position.
- The built-in bearing quill provide greater rigidity for heavyloads. The extension and retraction of the quill is programmable and thrust pressure adjustable.

**Ber.Co.** Engineering s.r.l.

MAGCHINE INTENSAMENTE USATE



( GS-6600L<sup>2</sup> model shown with optional accessories. )

# SUPER HEAVY-DUTY CONSTRUCTION

- ▶ Major structural components have been combined into one solid platform. The low center of gravity 45° slant bed design provides the most rigid foundation possible for the headstock, turret, and tailstock.
- ▶ By using Finite Element Methods ( FEM ), optimal reinforce ribbings are directly cast into the one-piece bed structure. Mechanical rigidity has been increased by more than 40 % when compared to conventional designs. The GS-6000L series is capable of performing super heavy-duty turning and maintain long-term super high precision accuracy. More rigidity also means extended tool life.
- ▶ Built to endure years and years of rigorous high production turning, the heavily ribbed, one-piece thermally balanced bed and casting components are of FC35-MEEHANITE casting ( industry standard is FC25~30 ). FC35 grade cast iron is capable of withstanding much greater stress without deforming and provides maximum vibration damping, which result in a machine that will outlast and outperform the competition.

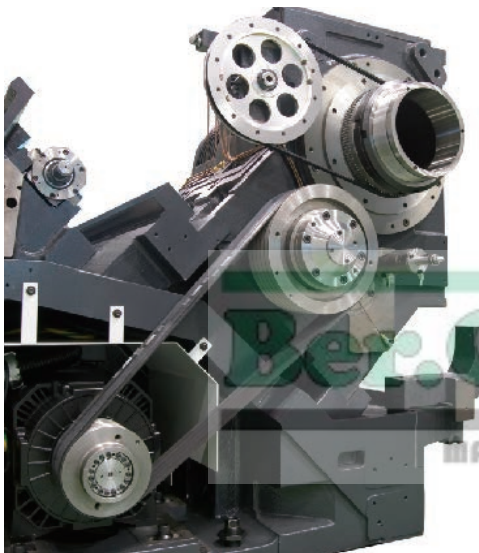

- ▶ The 2-speed super heavy-duty gear head incorporates advance mechanical designs. Mated with a 37 kW ( 30 min. ) motor to provide tremendous amount of low-end torque to handle heavy material removal on large diameter parts.
- ▶ X and Z axes are driven by over-sized FANUC  $\alpha$  i series absolute AC servo motors, providing tremendous thrust outputs with faster acceleration and deceleration. Absolute encoder technology saves time and money by eliminating the use of limit switches, thus, eliminating referencing axes to home positions and replacing broken limit switches.

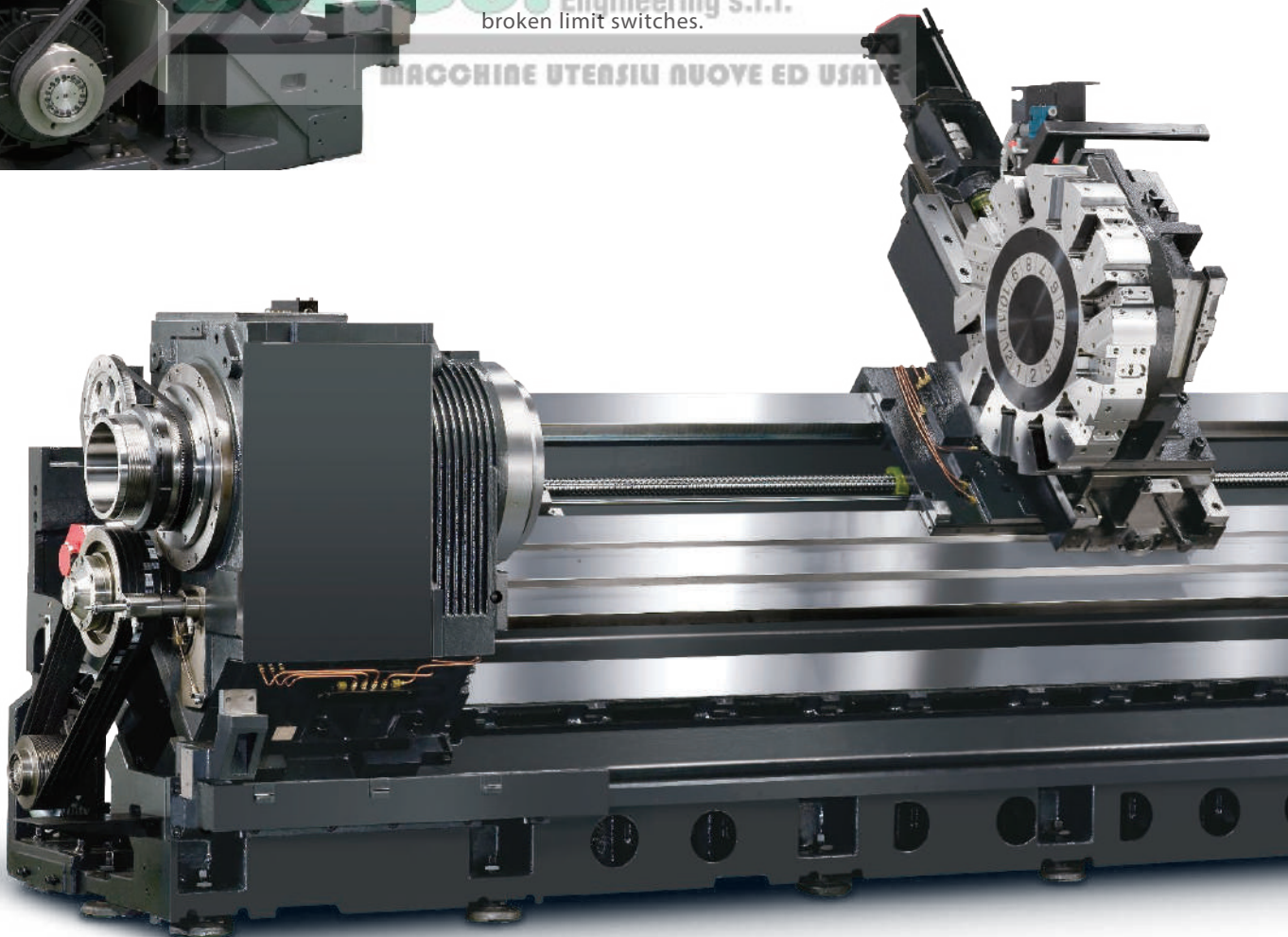



### 1 Box ways

Extra wide hardened and ground box ways are directly formed into the machine bed and saddle during the casting process. They are precision machined and widely spaced for maximum strength. The box way design also provides the rigidity needed for heavy-duty and interrupted turning applications.

### 2 Ball screws

C3 class hardened and precision ground ball screws ensure the highest accuracy and durability possible. Plus, pretension on all axes minimizes thermal distortion.

### 3 Z-axis

The L<sup>2</sup> and L<sup>3</sup> series Z-axis equipped with independent supporting mechanism prevents long-sized ball screws from deforming and ensures excellent performance for the axial feed and turning accuracy.

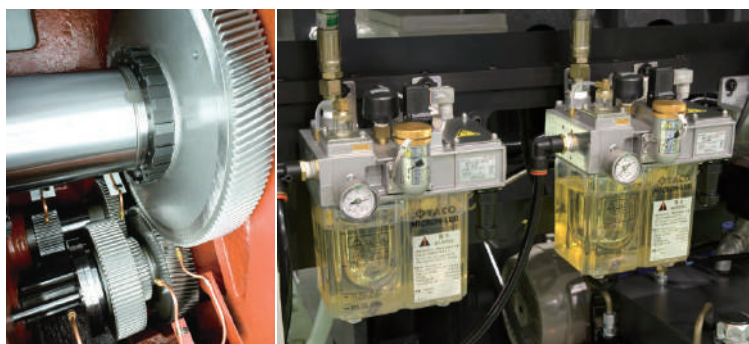
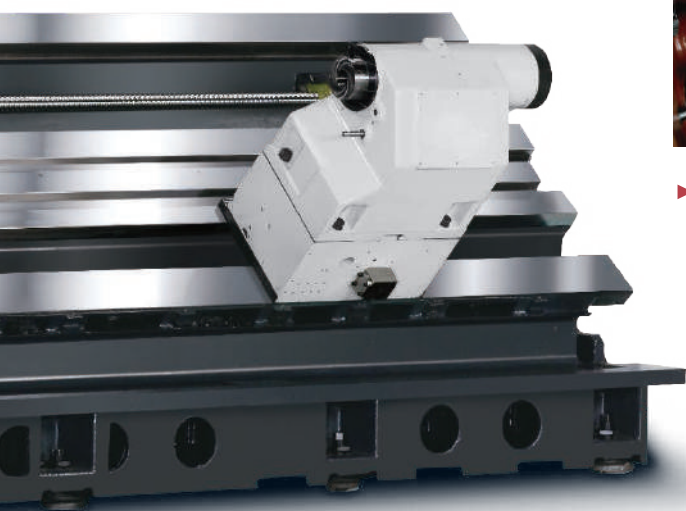
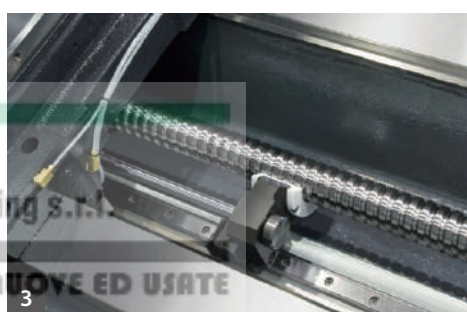
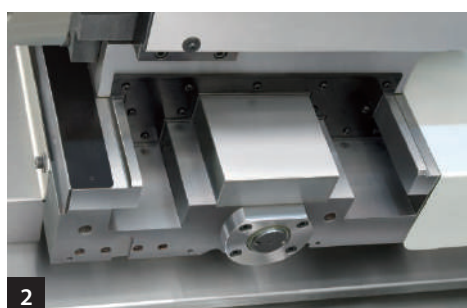

- ▶ Both gears and bearings are lubricated and cooled by an oil mist system, which evenly and efficiently lubricates the components. This system is much more advanced compared to the traditional oil bath system by eliminating the chance of oil contaminating the bearings.

( Casting structure of GS-6000L<sup>2</sup> model shown. )

# ULTIMATE TURNING POWER

- ▶ P4 grade ( Class 7 ) super-high precision bearings are directly assembled for maximum level of support and precision. Bearing configuration is designed for heavy-duty cutting with ultra-smooth performance and long term durability with a higher level of accuracy.
- ▶ With over 2,048 N-m of torque available on low speed of the 2-speed gear head, turning tough material with big diameter is now a simple task.

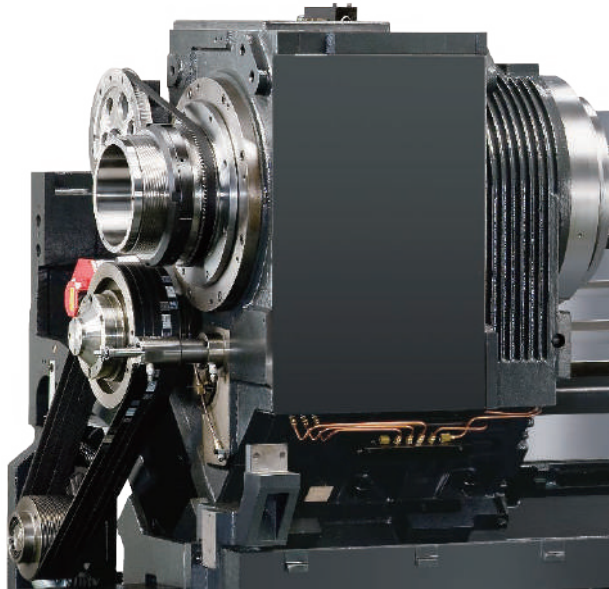
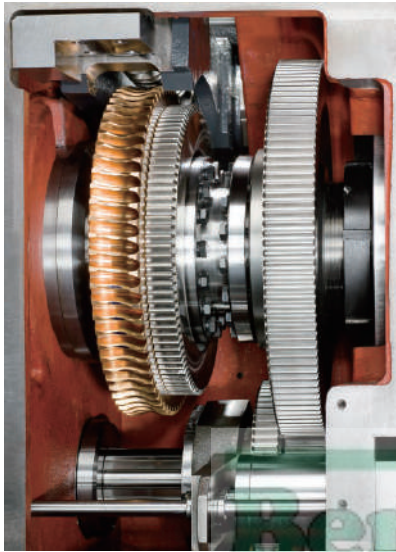

- ▶ Working with the live tooling turret, the Cf-axis and disk brake system enables the machine to perform multiple tasks, such as drilling, tapping and milling operations including cylindrical and polar coordinate interpolations, resembling a 4<sup>th</sup>-axis rotary table on a machining center.

## Spindle Output

## MACCHINE UTENSILI NUOVE ED USATE

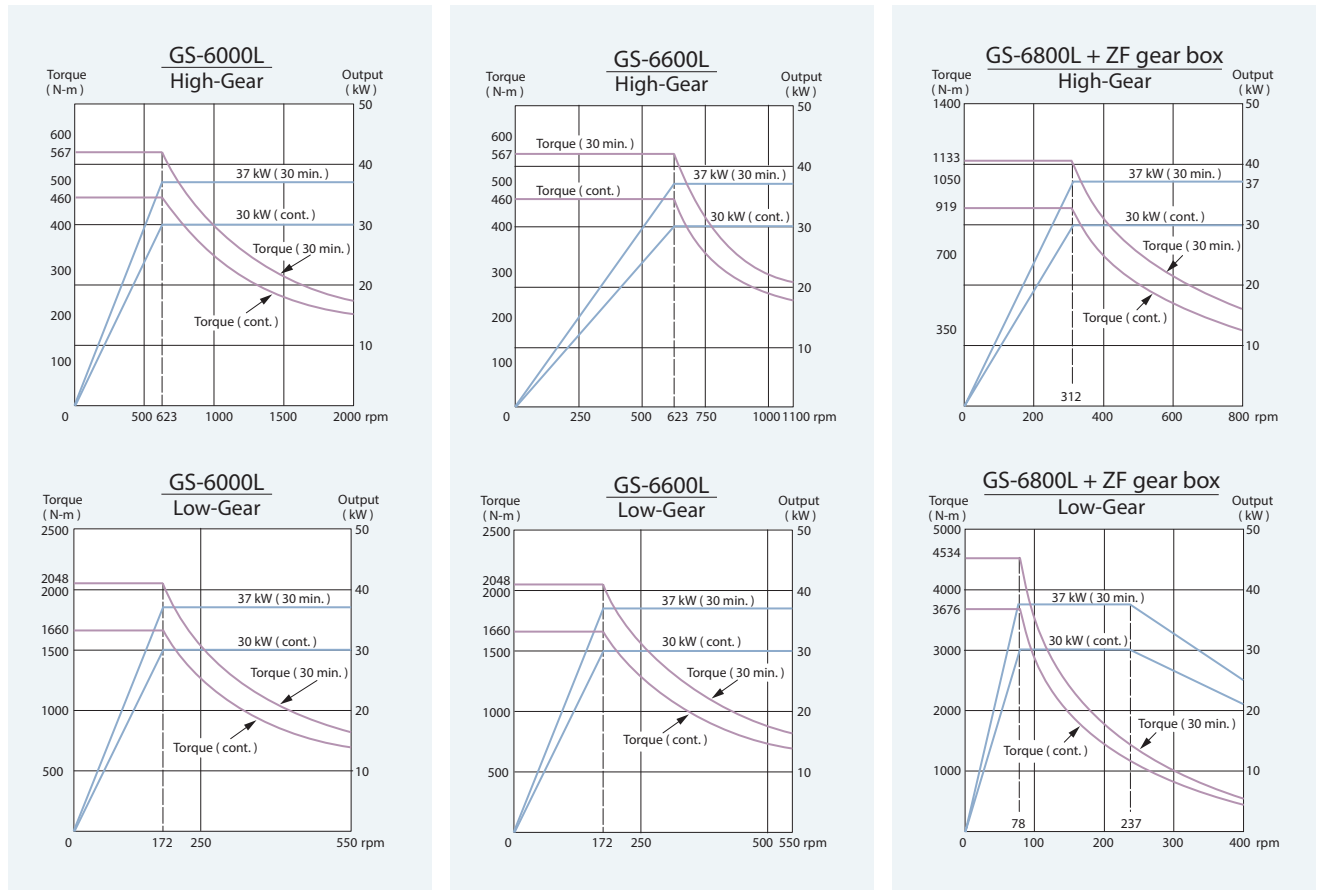

- ▶ The GS-6000L series is standard with a 2-step gear box. Optional oil bath GERMAN made ZF 3-step gear box is also available providing maximum torque up to 4,912 N-m.

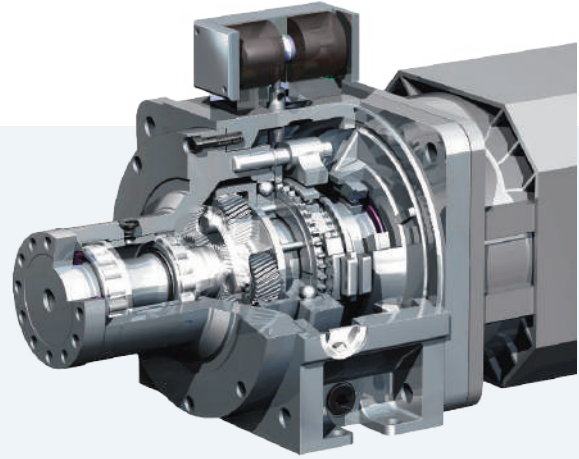

Optional ZF Gear Box Output

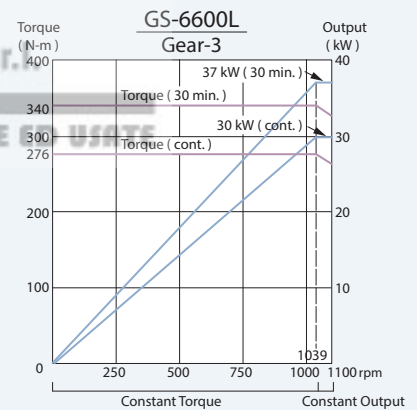
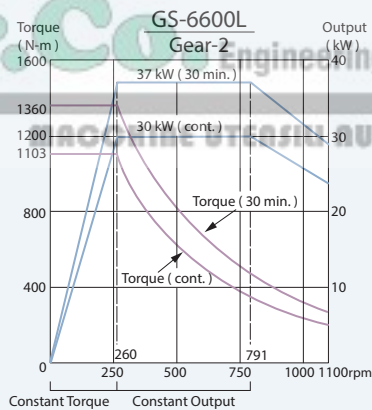
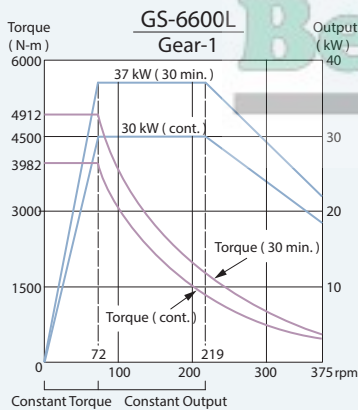
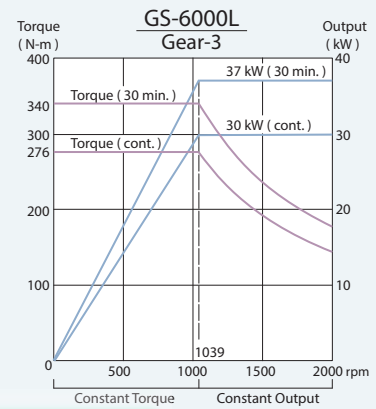
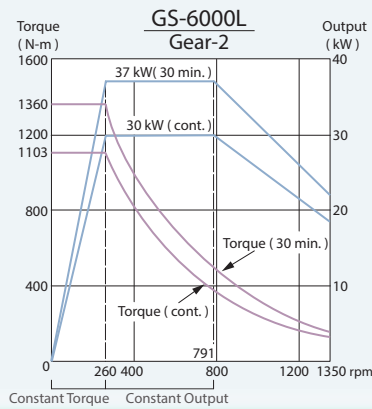
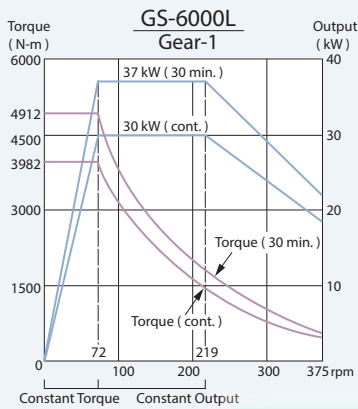

Front + Rear Chuck

By installing air or manual chucks on both the front and rear of the spindle, it becomes possible to machine the ends of long work-pieces. This configuration is especially useful in threading pipes.

- Rear chuck
- Work-piece
- Front chuck

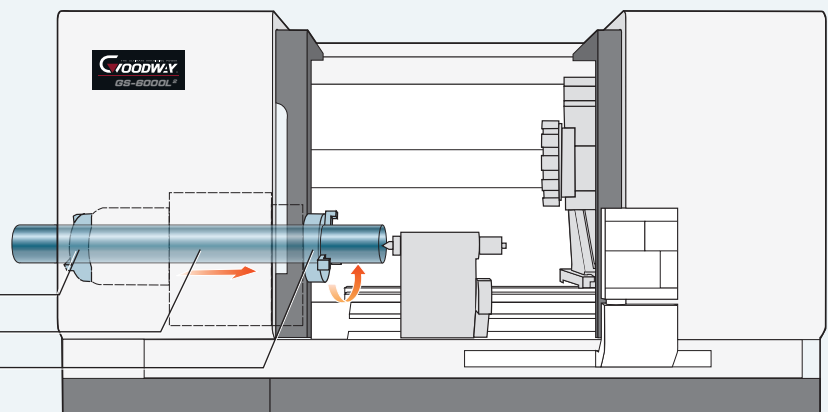



# ADVANCED TURRET TECHNOLOGY

- ▶ While competitors are cutting cost by using straight couplings on their turrets, we insist on using the finest CURVIC couplings available. The curvature of the CURVIC teeth provides a very unique self-centering feature and wider uniform tooth contact throughout all the teeth, therefore, achieving very high accuracy and rigidity. The CURVIC teeth are hardened to HRC 58, which ensures the coupling retains its high accuracy characteristics over long periods of use.
- ▶ 450 mm ( 17.7" ) diameter super high precision CURVIC couplings accurately position the turret disk (  $\pm 2$  sec. of arc ) and 12,000 Kg ( 26,400 lbs. ) of clamping force ensures abundant turret rigidity for all cutting conditions.
- ▶ The 12-station heavy-duty servo indexing turret achieves 1 second indexing times for adjacent stations and 2 second times for stations at the opposite end of the disk turret. Index movements are continues, without pauses, and is capable of turning 375 mm diameter work-pieces without interference when using boring tools. The optional 8-station turret even clears up to 584 mm diameter.

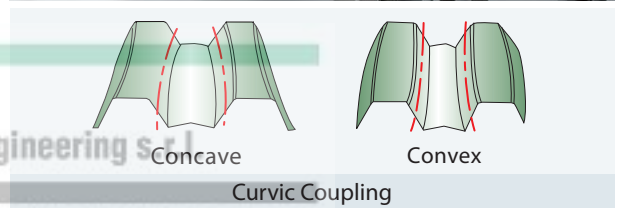
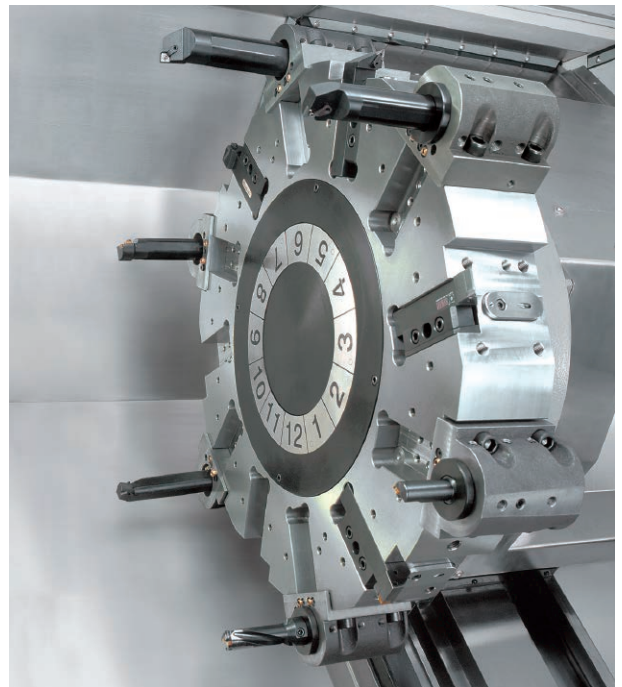

**Ber.Co.** Engineering Solutions  
 MAGCHINE UTENSILI NUOVE ED USATE

## [ Standard 12-Stations Turret ]

### Tooling System

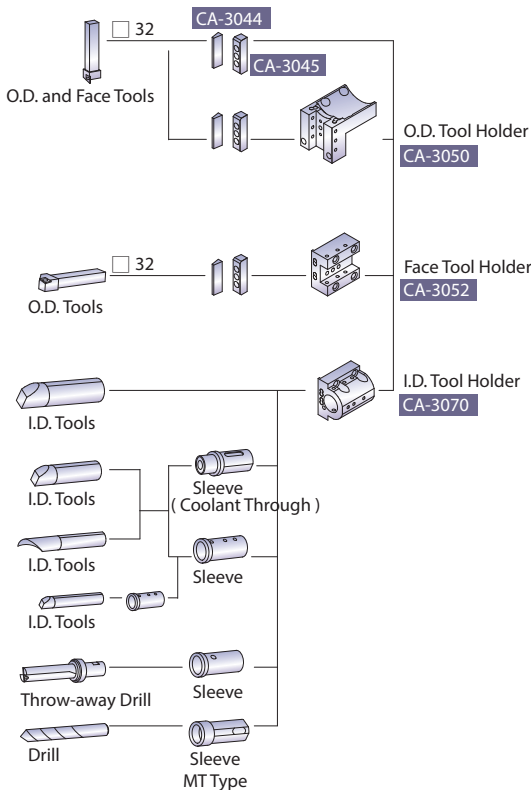

### Interference Diagram

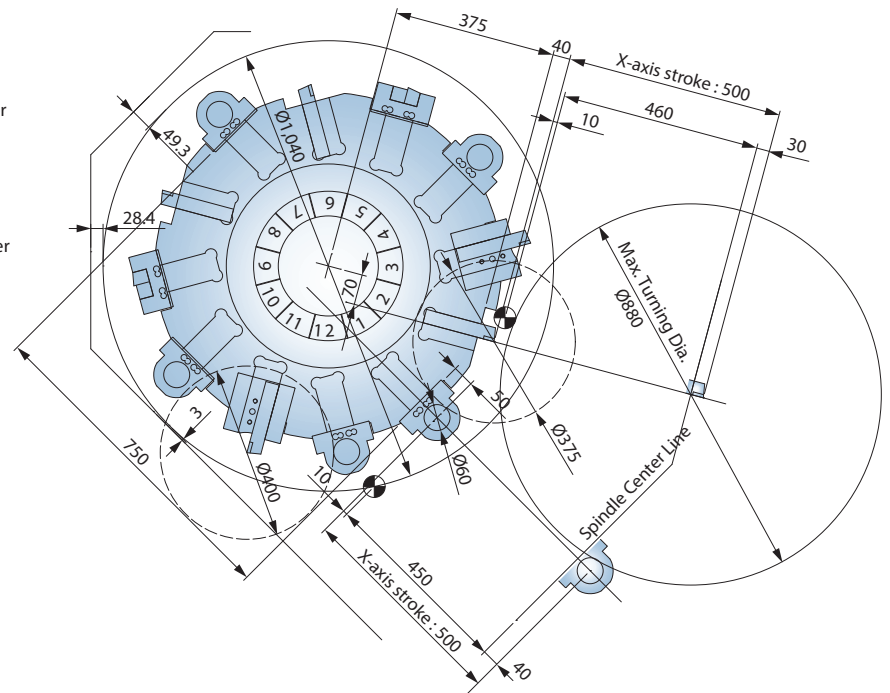

Unit : mm



## Work Range

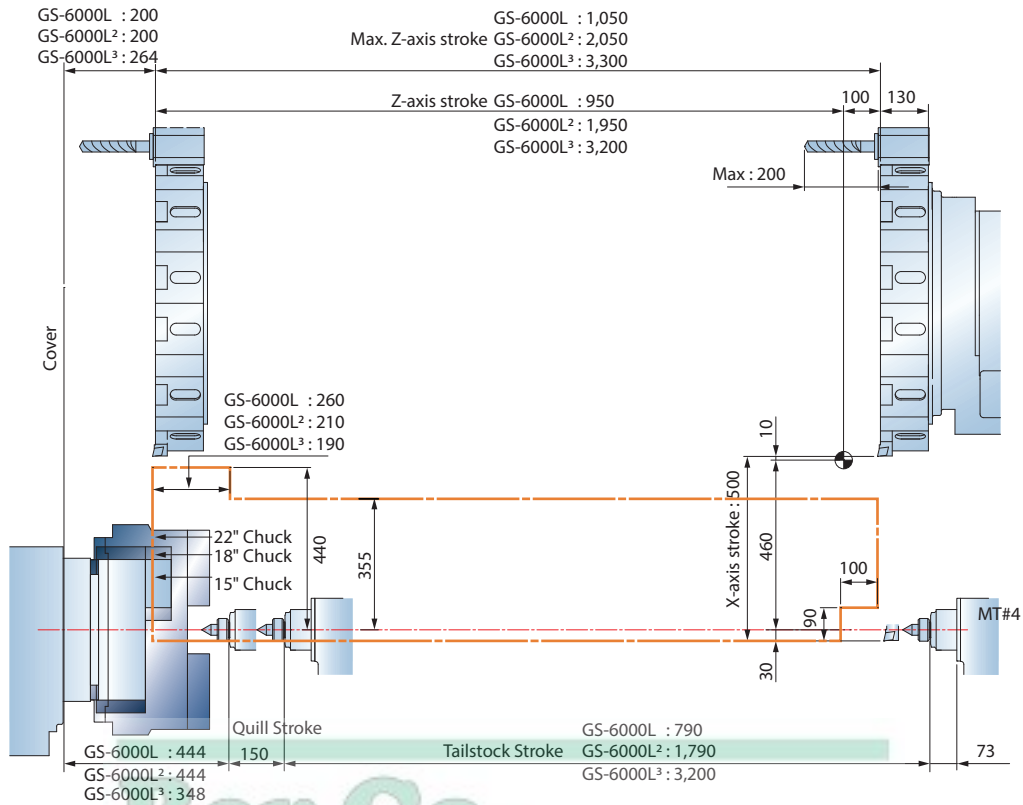

**Ber.Co.** Engineering s.r.l.

MAGCHINE UTENSILI NUOVE ED USATE

## 【 Optional 8-Stations Turret 】

### Tooling System

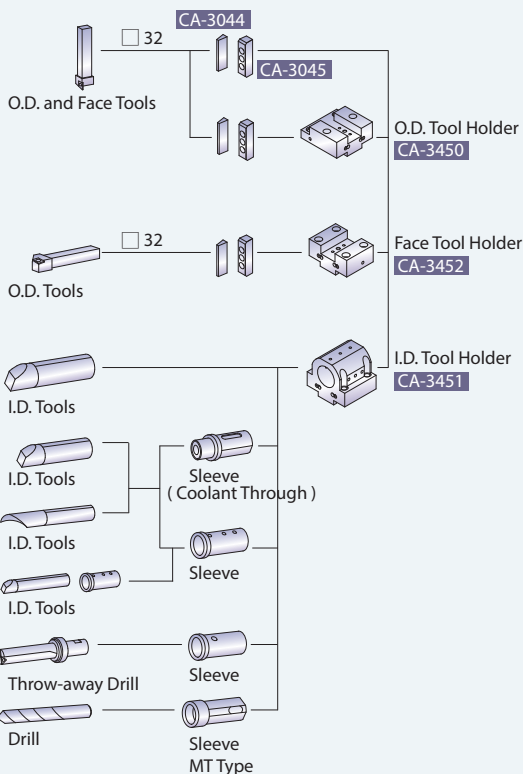

### Interference Diagram

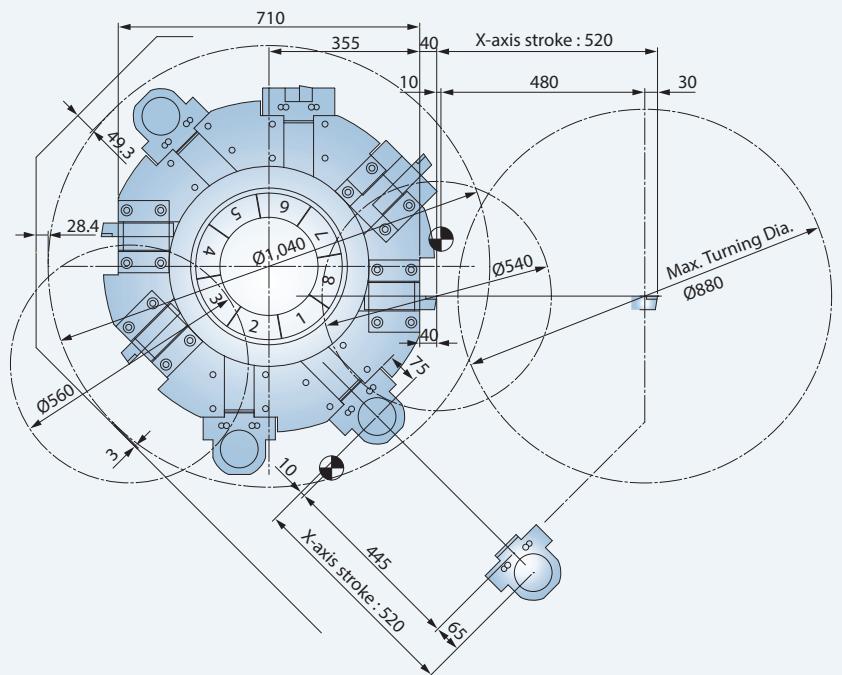

Unit : mm

\*1 Work range with 8-stations turret, please contact Goodway.

# LIVE TOOLING TURRETS

- ▶ Live tooling and C-axis control capabilities on the GS-6000L series allows the machine to perform multiple tasks on a workpiece, such as turning, milling, drilling and tapping. It eliminates manpower and cycle time, while reducing accuracy lost, which will occur if the part is moved from machine to machine.
- ▶ More powerful than a standard 50-taper machining center, the GS-6000L series live tooling turret is driven by a 9 kW ( 30 min. ) AC double wound high torque spindle motor to provide ample power, now, even the toughest of jobs may be tackled without a sweat. ( Please see page 12 for motor spec. )
- ▶ The 12-station GOODWAY live tooling turret offers 12 stations available for live tooling, live tools rotate in working position only to reduce power loss and heat.
- ▶ GOODWAY live tooling turret utilizes advance servo indexing technology to achieve 1 second indexing times for adjacent stations and 2 second for stations at the opposite end of the disk.



# ULTIMATE C-AXIS SPINDLE

- ▶ The Cf-axis and disk brake system available on the GS-6000L series provide the most rigid and powerful type of C-axis on the market today. In Cf-axis mode, a servo motor is engaged and drives the rotation of the spindle; engagement time is approximately 1 second.

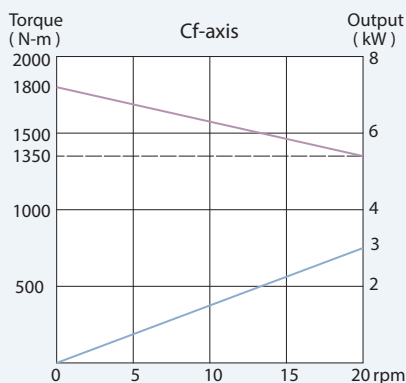

- ▶ Working with the live tooling turret, the Cf-axis and disk brake system enables the machine to perform multiple tasks, such as drilling, tapping, and milling operations, including cylindrical and polar coordinate interpolations, resembling a 4<sup>th</sup>-axis rotary table on a machining center.
- ▶ With the FANUC servo motor generating an ultra high resolution of 1,000,000 pulses per spindle rotation and 1,800 N-m of spindle torque ( cont. ), machined surface finishes are much superior than Cs-axis ( driven by spindle motor ) equipped machines. Plus, dynamic accuracy is within  $\pm 0.02^\circ$  even under heavy cutting loads.

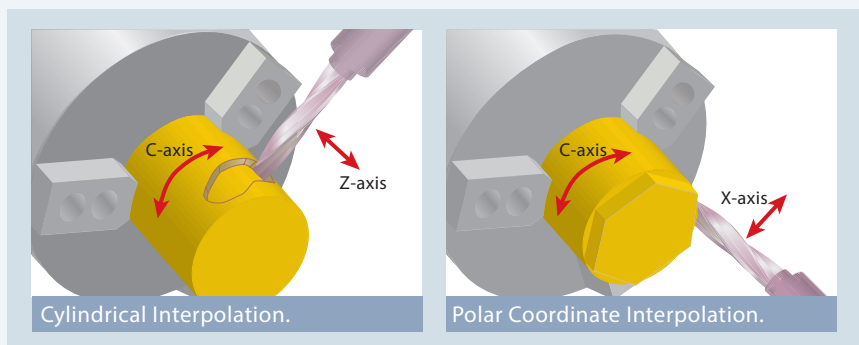
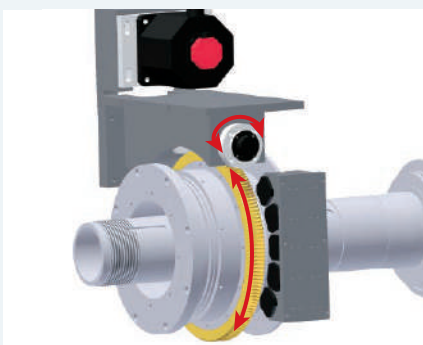

**[ Optional Live Tooling Turret ]**

**Work Range**

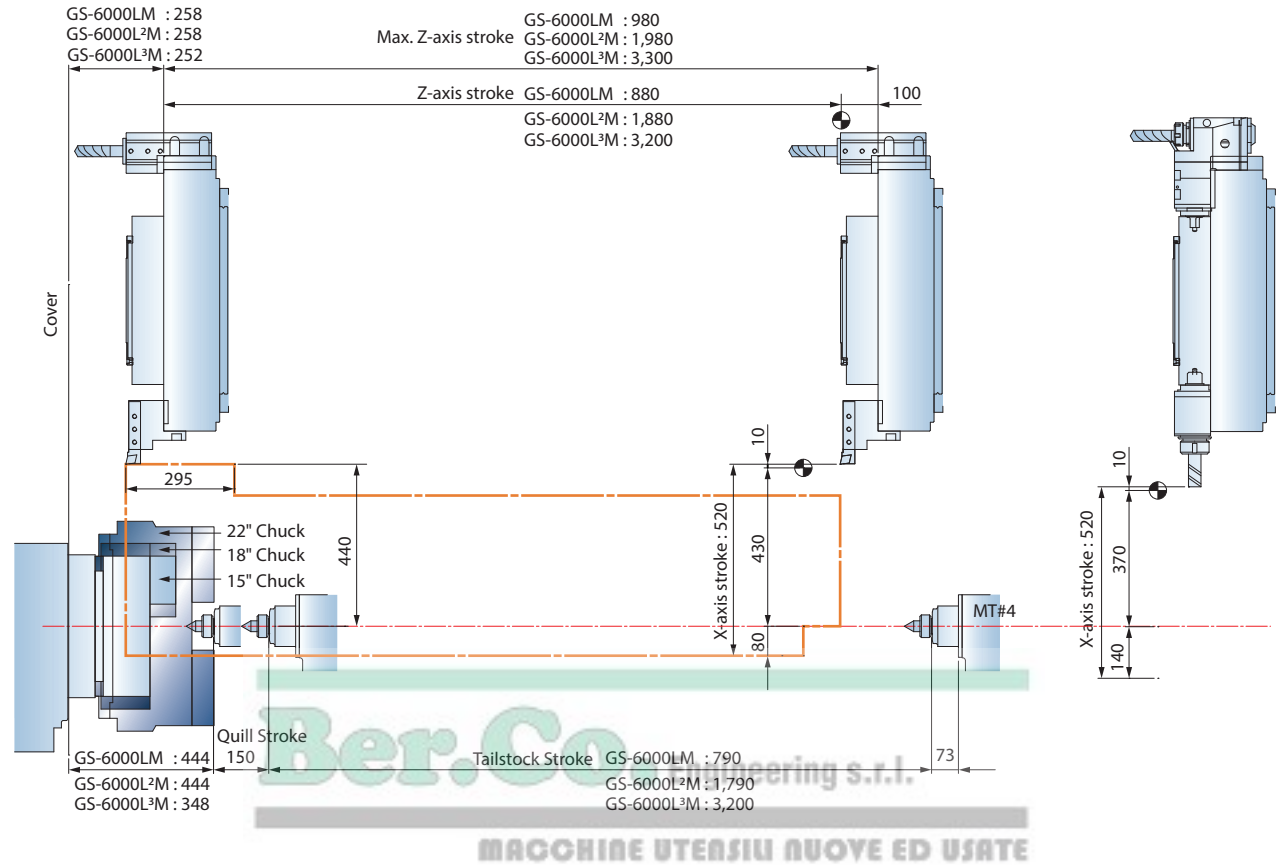

**Tooling System**

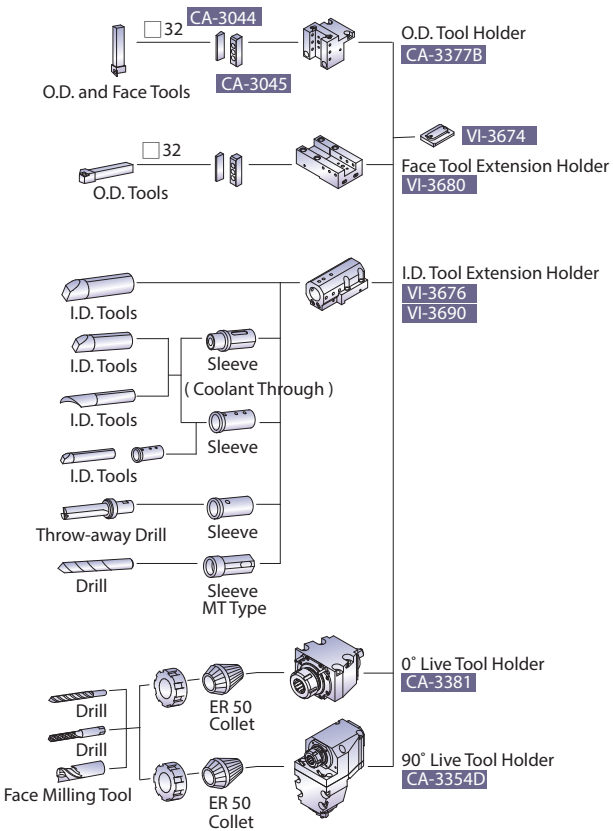

**Interference Diagram**

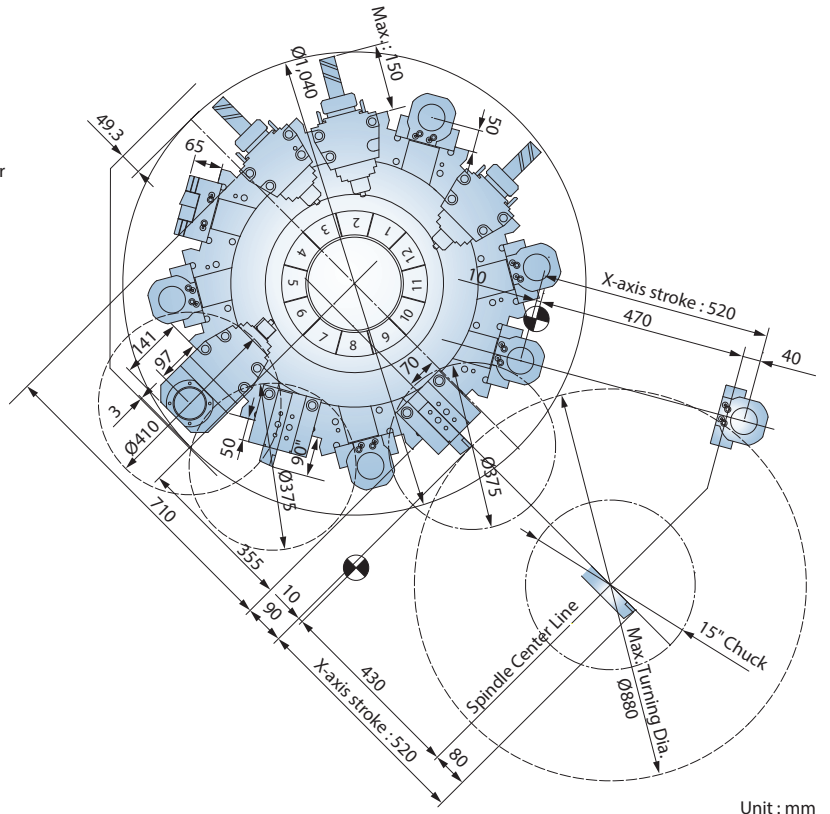



# MACHINING PERFORMANCE



**Ber.Co. Engineering s.r.l.**  
 MACCHINE UTENSILI-AUOVE ED USATE

## O.D. Heavy Cutting Example



Tools (mm)	O.D. Before Cut (mm)	O.D. After Cut (mm)	Depth of Cut (mm)	Spindle Speed (rpm)	F/Rev. (mm/rev.)	Spindle Load	Z-axis Load
□ 32	Ø 215	Ø 195	10	195	0.8	97 %	60 %

Raw Material : S45C Model : GS-6000LM

## Drill Example



Tools (mm)	I.D. Before Cut (mm)	I.D. After Cut (mm)	Spindle Speed (rpm)	F/Rev. (mm/rev.)	Tap Diameter (mm)	Spindle Load	Z-axis Load
Ø 58	-	-	878	0.3	-	123 %	110 %

Raw Material : S45C Model : GS-6000LM

### Machining Capability

	Tools (mm)	Spindle Speed (rpm)	Feedrate (mm/min)	Cutting Speed (m/min)	Cutting Depth (mm)
Drill	Ø 40 HSS	200	48	25	N/A
End mill	Ø 32 HSS 4-flute Rough End mill	375	120	30	25
Tapping	M24 * P3.0	106	318	8	30

Raw Material : S45C Model : GS-6000LM

### Live Tooling Turret

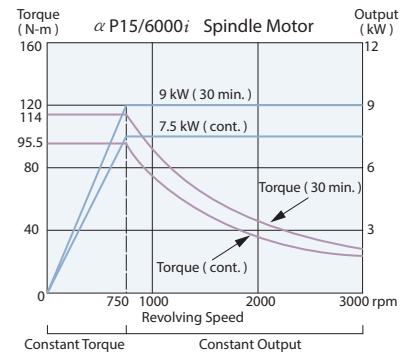

### Specification of Live Tooling Turret

Drive Motor Power (cont.)	Drive Motor Power (30 min.)	Max. tapping Capacity	Max. Milling Capacity	Gear Ratio
7.5 kW (10 HP)	9 kW (12 HP)	M24 mm	Ø 40 mm	1 : 1

GOODWAY Multi-tasking machine can perform the functions below in one setup :



### Sample Work-pieces





# FEATURES

## [ Standard Features ]



### Chip Conveyor

- ▶ The standard chip conveyor features adjustable timers that allow the operator to set operation intervals according to the amount of chips generated by the machine. Thus, reducing coolant loss to a minimum.

### Separate Coolant Tank



### Tri-color status light



## [ Optional Features ]



3-Jaw chuck w/ Soft Jaws x 1 set

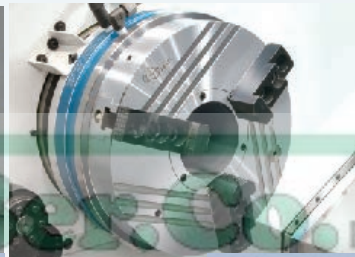

Air Chuck

- ▶ The air chuck can work with soft or thin materials to prevent from deforming rather than using a hydraulic chuck.

### Steady Rest ( Apply for Long Work-piece )

- ▶ The manual steady rest is adjusted manually which increases accuracy and requires less space than hydraulic steady rests.
- ▶ The automatic steady rest is controlled by a program which increases working efficiency.



Manual Steady Rest



Hydraulic Steady Rest

TOOL ID	TOOL NAME	TOOL LIFE	TOOL BREAK VALUE	TOOL STATUS
0001	T1	100	10	OK
0002	T2	200	20	OK
0003	T3	300	30	OK
0004	T4	400	40	OK
0005	T5	500	50	OK
0006	T6	600	60	OK
0007	T7	700	70	OK
0008	T8	800	80	OK
0009	T9	900	90	OK
0010	T10	1000	100	OK

### Load Monitoring

- ▶ The load monitoring function is used to detect abnormal load of tools by monitoring the variation in spindle motor and servo motor loads during the cutting process. When abnormal loads are detected, the machine will stop at program end ( M30 ) or immediately ( feed hold status ) according to tool life value or tool break value respectively.



### Oil Skimmer

- ▶ The optional oil skimmer removes lubrication oil from the coolant tank, thus, keeping the coolant fresh and minimizes manual cleaning .

### Tool Setter

- ▶ The optional Renishaw HPA tool presetter simplifies machining setup.





S : Standard      O : Option  
 - : Not Available    C : Contact GOODWAY

		GS-600L	GS-660L	GS-680L
<b>SPINDLE</b>				
Main spindle configuration	2-Speed Gear	S	S	S
Rigid tapping & spindle orientation		S	S	S
Main spindle disk brake		O	O	O
Cf-axis*1		O	O	O
<b>WORK HOLDING</b>				
Hydraulic hollow cylinder for chuck	115 mm ID.	S	-	-
	180 mm ID.	-	O	-
	205 mm ID.	-	O	-
	260 mm ID.	-	-	O
Hollow 3-jaws chuck & 1 set soft jaws	15"	S	-	-
	18"	O	-	-
	20" ( 180 mm ID. )	-	O	-
	21"	-	O	-
	24"	-	-	O
	Air Chuck	O	O	O
Hard jaws		O	O	O
Special work holding chuck		C	C	C
In spindle work stopper		O	O	O
Spindle liner ( guide bushing )		O	O	O
Foot switch for chuck operation		S	S	S
Programmable base & quill hydraulic tailstock		S	S	S
MT#4 dead center quill		S	S	S
MT#5 live center quill		O	O	O
MT#5 dead center quill		O	O	O
MT#6 live center quill		O	O	O
Foot switch for tailstock operation		O	O	O
Manual steady rest		O	O	O
Self-centering hydraulic steady rest		O	O	O
Foot switch for steady rest operation		O	O	O
Two-stage programmable pressure	Chuck clamping	O	O	O
	Tailstock thrust	O	O	O
<b>TURRET</b>				
8-station turret		O	O	O
12-station turret		S	S	S
12-station live tooling turret		O	O	O
Tool holder & sleeve package		S	S	S
Live tooling tool holders ( 0° x 2 , 90° x 2 ) *1		O	O	O
<b>MEASUREMENT</b>				
RENISHAW HPRA tool presetter	Removeable	O	O	O
<b>COOLANT</b>				
Coolant pump	3 Kg/cm <sup>2</sup>	S	S	S
	5 Kg/cm <sup>2</sup>	O	O	O
High-pressure coolant system	20 Kg/cm <sup>2</sup>	C	C	C
Roll-out coolant tank		S	S	S
Oil skimmer		O	O	O
Coolant flow switch		O	O	O
Coolant level switch		O	O	O
Coolant intercooler system		O	O	O
<b>CHIP DISPOSAL</b>				
Chip conveyor with auto timer	Right discharge	S	S	S
	Rear discharge	C	C	C
Chip cart with coolant drain		O	O	O
Chuck air blow		O	O	O
Tailstock air blow		O	O	O
Coolant gun		O	O	O
Oil mist collector		O	O	O
<b>AUTOMATIC OPERATION SUPPORT</b>				
Bar feeder		O	O	O
Bar feeder interface		O	O	O
Gantry-type loader / unloader		O	O	O
Auto door		O	O	O
External M-code output	4 sets ( 8 )	O	O	O
	8 sets ( 16 )	O	O	O
<b>SAFETY</b>				
Fully enclosed guarding		S	S	S
Door interlock ( incl. Mechanical lock )		S	S	S
Impact resistant viewing window		S	S	S
Tailstock stroke out-end check		S	S	S
Chuck cylinder stroke out-end check		S	S	S
Chuck cylinder check valve		S	S	S
Low hydraulic pressure detection switch		S	S	S
Over travel ( soft limit )		S	S	S
Load monitoring function		S	S	S

		GS-600L	GS-660L	GS-680L
<b>OTHERS</b>				
Electrical cabinet	Heat exchanger	S	S	S
	A/C cooling system	O	O	O
Complete hydraulic system		S	S	S
Advanced auto lubrication system		S	S	S
Foundation leveling & maintenance tool kit		S	S	S
Emergency maintenance electrical part package		S	S	S

		O <sub>i</sub> -TF	31i	
<b>FANUC CONTROL FUNCTIONS</b>				
Display	10.4" color LCD	S	S	
	Standard	S	S	
Graphic function	Dynamic*2	O	O	
	512K bytes	S	-	
Part program storage size	1M bytes	O	S	
	O <sub>i</sub> -TF : each path	2M bytes	O	O
	31i : total	4M bytes	-	O
	8M bytes	-	O	
Registerable programs	400	S	-	
	O <sub>i</sub> -TF : each path	1,000	O	S
	31i : total	4,000	-	O
	99	-	S	
Tool offset pairs	128	S	-	
	200	O	O	
	400	-	O	
	499	-	O	
Servo HRV control	999	-	O	
	2000	-	O	
	HRV 3	S	S	
	Automatic data backup	S	S	
Synchronous / Composite control	O	O		
Inch / metric conversion	S	S		
Polar coordinate interpolation	S	S		
Cylindrical interpolation	S	S		
Multiple repetitive cycle	S	S		
Rigid tapping	S	S		
Unexpected disturbance torque detection function	S	S		
Spindle orientation	S	S		
Spindle speed fluctuation detection	S	S		
Embedded macro	O	O		
Spindle synchronous control	S	S		
Tool radius / Tool nose radius compensation	S	S		
Multi-language display	S	S		
Polygon turning	S	S		
Helical interpolation	O	O		
Direct drawing dimension programming	S	S		
Thread cutting retract	S	S		
Variable lead threading	S	S		
Multiple repetitive cycle II	S	S		
Canned cycles for drilling	S	S		
Tool nose radius compensation	S	S		
Chamfering / Corner R	S	S		
AI contour control I	O	S		
Multi part program editing	S	S		
Manual handle retrace	O	O		
Manual intervention and return	S	O		
External data input	S	S		
Addition of custom macro	S	S		
Increment system C	S	S		
Run hour & parts counter	S	S		
Auto power-off function	S	S		
RS-232 port	S	S		
Memory card input / output ( CF + USB )	S	S		
Ethernet	S	S		

Specifications are subject to change without notice.  
 Above standard & optional features also apply to "L2" & "L3" models.  
 \*1 Standard on "M" ( live tooling ) models.  
 \*2 Cannot coexist with MANUAL GUIDE *i*

# GENERAL DIMENSION

## Foot - Print

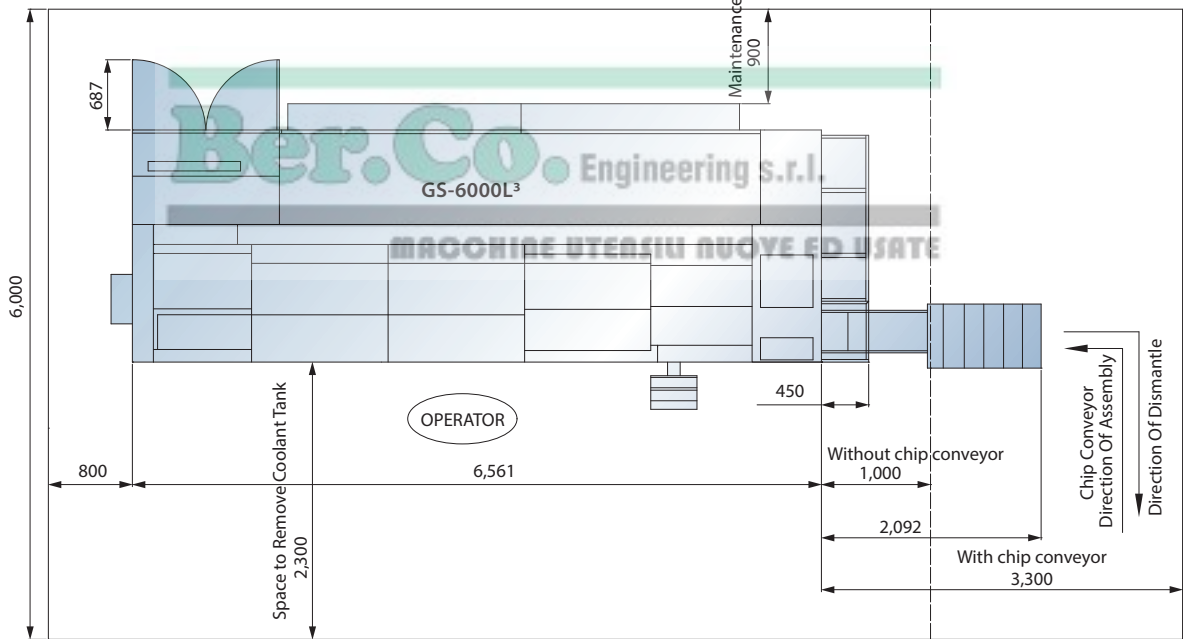
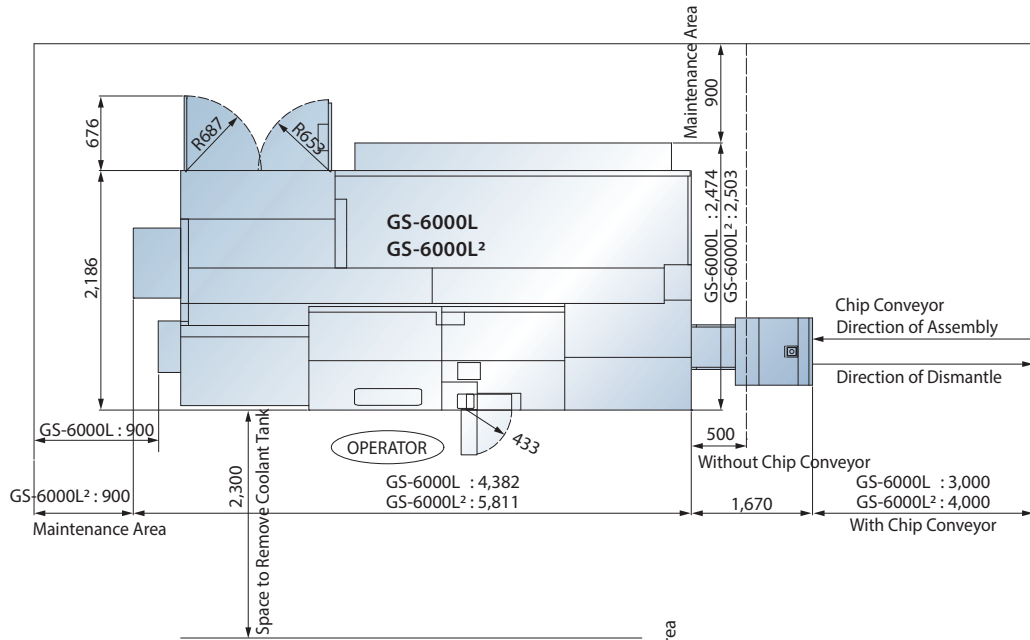

## Machine Layout

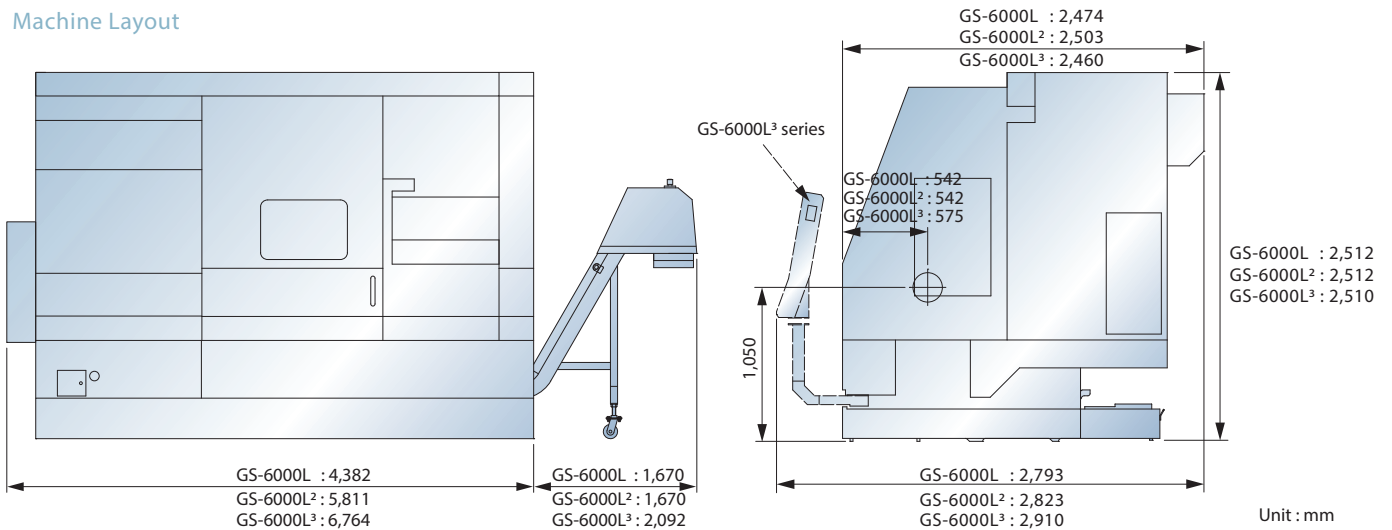

Foundation Requirement

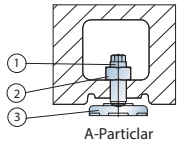
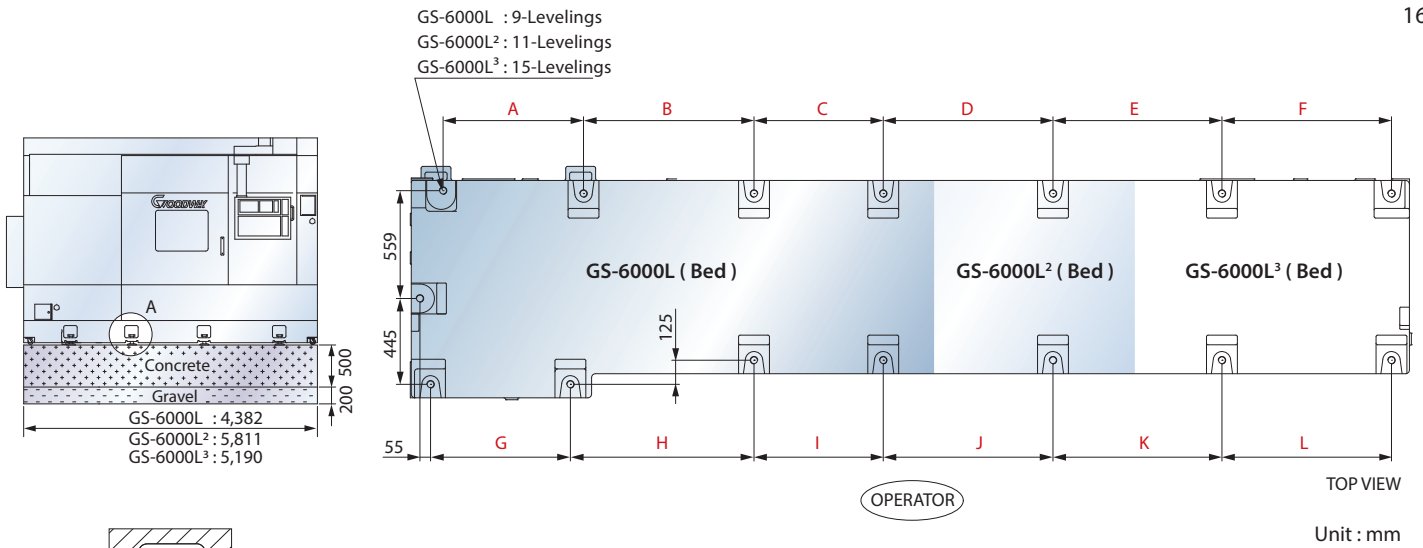

No.	Part No.	Part name
1	CA-1029	Leveling Bolt
2	NA3900BA	Hex. Nut M39
3	CA-1030	Leveling Block

Model	A	B	C	D	E	F	G	H	I	J	K	L
GS-6000L	718	804	895	-	-	-	725	862	895	-	-	-
GS-6000L²	718	884	976	879	-	-	725	942	976	879	-	-
GS-6000L³	718	884	980	730	716	879	728	942	780	730	716	879

Ber.Co. Engineering s.r.l.

Lifting by Overhead Crane

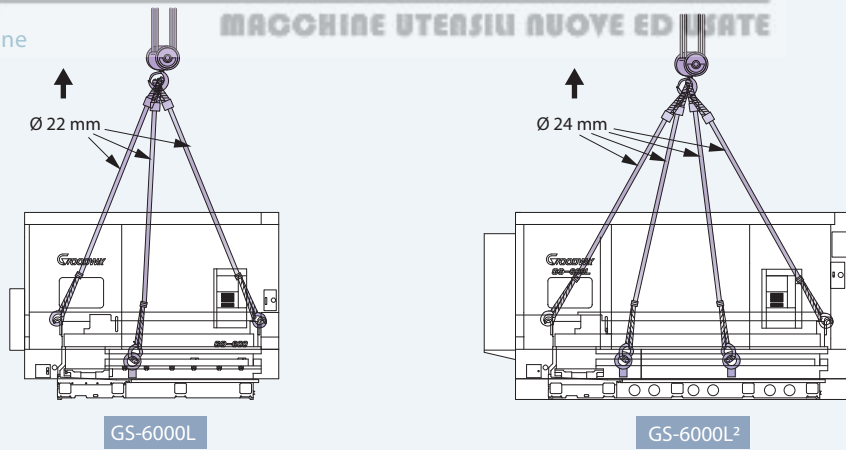

Lifting by Forklift

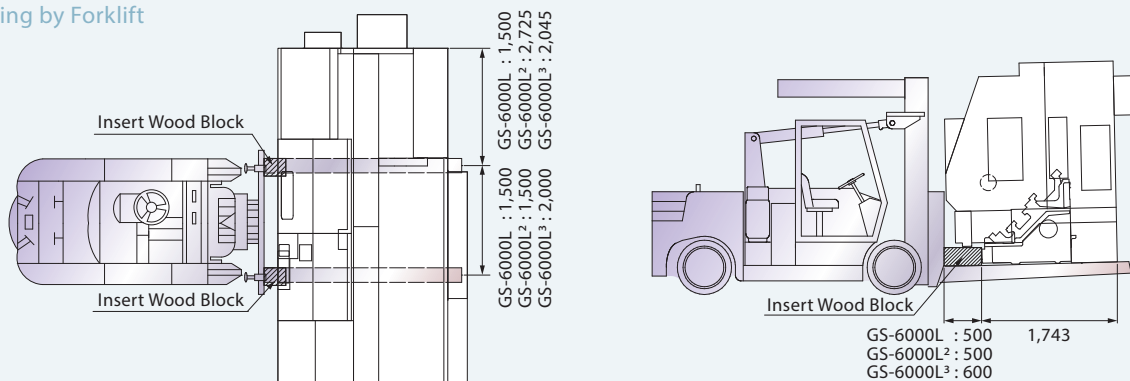



# MACHINE SPECIFICATIONS

■ : Metric ■ : Inch

CAPACITY	GS-6000L / L <sup>2</sup> / L <sup>3</sup>		GS-6600L / L <sup>2</sup> / L <sup>3</sup>		GS-6800L / L <sup>2</sup> / L <sup>3</sup>
Max. swing diameter			Ø 980 mm 38.58"		
Swing over saddle			Ø 710 mm 27.95"		
Max. turning diameter			Ø 880 mm 34.64"		
Max. turning length			1,020 / 2,020 / 3,300 mm 40.15" / 79.52" / 129.9"		
Chuck size	15" ( Opt. 18" )	20" ( Opt. Hyd. Chuck )	22" ( Opt. Air Chuck )	24" ( Opt. Air Chuck )	
Bar capacity	Ø 115 mm 4.52"	Ø 180 mm 7.08"	Ø 205 mm 8.07"	Ø 260 mm 10.23"	
<b>SPINDLE</b>					
Hole through spindle	Ø 118 mm 4.64"	Ø 181 mm 7.12"	-		-
Spindle bearing diameter	Ø 131 mm 5.15"	Ø 205 mm 8.07"		Ø 260 mm 10.23"	
Hydraulic cylinder	Ø 15"	Ø 20"	-		-
Spindle nose	A2-11	A2-15		A2-15	
Motor output ( Cont. )			30 kW 40 HP		
Motor output ( 30 min. )			37 kW 50 HP		
Motor full output speed			1,150 rpm		
Spindle drive system			V-Belt + Gear Box		
Spindle drive ratio	L	0.15	0.15		0.068
	H	0.54	0.54		0.271
Spindle speed range	L	550 rpm	550 rpm		400 rpm
	H	2,000 rpm	1,100 rpm		800 rpm
Spindle full output speed ( 30 min. )	L	2,048 N-m 1,510 lb-ft	2,048 N-m 1,510 lb-ft		1,133 N-m 835 lb-ft
	H	567 N-m 418 lb-ft	567 N-m 418 lb-ft		4,533 N-m 3,343 lb-ft
<b>X &amp; Z AXES</b>					
Max. X-axis travel*1			500 mm 19.68"		
Max. Z-axis travel*1			1,050 / 2,050 / 3,300 mm 41.33" / 80.7" / 129.9"		
X-axis rapids			20 m/min. 788 IPM		
Z-axis rapids			24 / 24 / 12 m/min. 945 / 945 / 472 IPM		
Slide way type			Box Way		
Feed rates			1 ~ 4,800 mm/min. 1 ~ 189 IPM		
X-axis servo motor			AC 6 kW 8 HP		
Z-axis servo motor			AC 7 kW 9.4 HP		
X-axis ball screw Ø [ pitch ]			Ø 40 mm [ 8 mm ] 1.57" [ 0.31" ]		
Z-axis ball screw Ø [ pitch ]			Ø 45 mm [ 12 mm ] / Ø 50 mm [ 16 mm ] / Ø 63 mm [ 16 mm ] 1.77" [ 0.47" ] / 1.96" [ 0.62" ] / 2.48" [ 0.62" ]		
X / Z axes thrust ( cont. )			3,046 / 2,404 Kg 6,715 / 5,299 lb		
<b>TURRET</b>					
Stations			12		
Indexing drive			FANUC AC Servo motor		
Indexing speed			1 sec. ( Adjacent ) / 2 sec. 180° ( Single step )		
Accuracy			Positioning : ± 0.00069°, Repeatability : ± 0.00027°		
O.D. tool shank size			□ 32 mm 1-1/4"		
I.D. tool shank size			Ø 60 mm 2-1/2"		

LIVE TOOLING TURRET ( OPT. )	GS-6000L / L <sup>2</sup> / L <sup>3</sup>	GS-6600L / L <sup>2</sup> / L <sup>3</sup>	GS-6800L / L <sup>2</sup> / L <sup>3</sup>
Max. turning length	900 / 1,900 / 3,200 mm 35.43" / 74.8" / 125.9"		
Max. turning diameter	Ø 880 mm 34.6"		
Stations	12		
Live tooling stations	12 ( Live tooling tools rotate in working position only )		
Live tooling drive motor ( cont. / 30 min. )	AC 7.5 / 9 kW 10 / 12 HP		
Live tooling torque	120 N-m 88 lb-ft @ 750 rpm ( 30 min. )		
Indexing drive type	FANUC AC Spindle motor		
Index speed	1 sec. ( Adjacent ) / 2 sec. 180 degree ( Single step )		
O.D. tool shank size	□ 32 mm 1-1/4"		
I.D. tool shank size	Ø 60 mm 2-1/2"		
Live tooling shank size	ER 50 ( Ø 30 mm ) 1.18"		
Live tooling RPM range	10 ~ 3,000 rpm		
<b>Cf-AXIS ( OPT. )</b>			
Cf-axis drive ratio	1 : 150		
Cf-axis rapids	20 rpm		
Cf-axis torque output ( cont. )	1,800 N-m 1,327 lb-ft		
Min. spindle indexing angle	0.001°		
Dynamic accuracy	± 0.02°		
<b>TAILSTOCK</b>			
Quill center taper	MT#4 ( Dead center ) [ Opt. MT#5 ( Live center ), MT#5 ( Dead center ), MT#6 ( Live center ) ]		
Quill diameter / travel	Ø 110 / 150 mm 4.3" / 5.9" [ Opt. Ø 160 / 150 mm 6.2" / 5.9" *2 Ø 120 / 150 mm 4.7" / 5.9" *3 ]		
Tailstock base travel	790 / 1,790 / 3,200 mm 31.1" / 70.47" / 125.9"		
Programmable quill / base	Yes / Yes		
Programmable base type	Position by Z-axis		
<b>GENERAL</b>			
Positioning accuracy ( X / Z )	0.015 mm 0.00059" *4		
Repeatability ( X / Z )	± 0.003 mm ± 0.000118" *4		
NC controller	FANUC Oi - TF ( Opt. 31 i )		
Voltage / Power requirement	AC 200 / 220 +10% to -15% 3 phase / 55 kVA		
Air pressure	6 kgf / cm <sup>2</sup> 85.2 PSI		
Hydraulic tank capacity	15 L 3.9 gal		
Coolant tank capacity	240 / 320 / 680 L 63 / 84 / 179 gal		
Coolant pump	1 kW ( 1.5 HP , 60 Hz ) rated at 5 bar ( 72 PSI )		
Machine weight	12,000 / 16,000 / 18,000 Kg 27,000 / 36,000 / 40,000 lb		
Dimensions L × W × H	3,696 x 2,422 x 2,570 / 5,060 x 2,422 x 2570 / 6,764 x 2,910 x 2,510 mm 146" x 96" x 102" / 200" x 96" x 102" / 267" x 115" x 99"		

Specifications are subject to change without notice.

\*1 The specification of each model may be slightly different, please refer to the interference diagram.

\*2 Option dead center MT#5.

\*3 Option live center MT#6.

\*4 Measurement is based on JIS B 6331.



**Ber.Co.** Engineering s.r.l.

MACCHINE UTENSILI NUOVE ED USATE



GOODWAYCNC.com

## GOODWAY MACHINE CORP.

### HEADQUARTERS

No.13, 5<sup>th</sup> Road,  
Taichung Industrial Park,  
Taichung City, 407, Taiwan  
E-mail : [goodway@goodwaycnc.com](mailto:goodway@goodwaycnc.com)

### CENTRAL TAIWAN SCIENCE PARK BRANCH

No. 38, Keyuan Road,  
Central Taiwan Science Park.Taichung,  
Taichung City, 407, Taiwan  
TEL : + 886-4-2463-6000  
FAX : + 886-4-2463-9600

### GOODWAY MACHINE ( WUJIANG ) CO.,LTD

No. 4888, East Lake Taihu Avenue, Wujiang  
Economic and Technological Development Zone,  
Jiangsu, China  
Sales Hotline : + 86-512-8286-8068  
Service Hotline : + 86-512-8286-8066  
FAX : + 86-512-8286-8620  
E-mail : [goodway@goodwaycnc.cn](mailto:goodway@goodwaycnc.cn)