

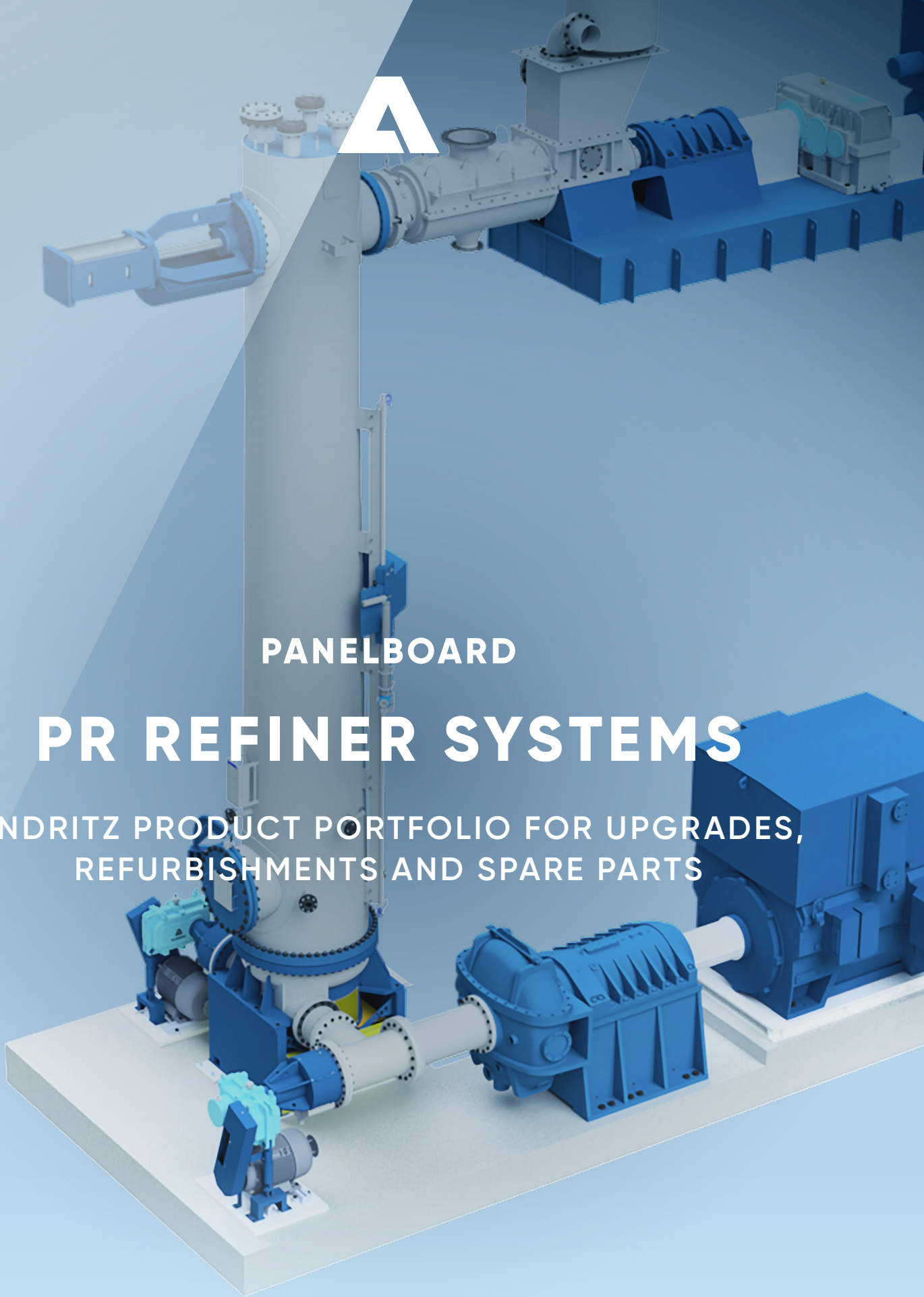

PANELBOARD

PR REFINER SYSTEMS

ANDRITZ PRODUCT PORTFOLIO FOR UPGRADES,
REFURBISHMENTS AND SPARE PARTS



ANDRITZ

ENGINEERED SUCCESS

Boost performance, increase plant availability and reduce maintenance costs with ANDRITZ upgrades for your PR refiner systems.



Due to their rough operating conditions, all refining systems in MDF plants are subject to considerable wear that requires time-consuming and expensive maintenance work. For this reason, ANDRITZ has developed new and innovative concepts to increase the performance of your refiner system and improve plant availability to the maximum. Our solutions that will help you achieve this are listed in the following product overview.

CONTENT

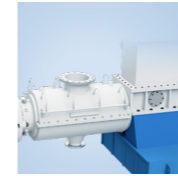

PRE-STEAMING BIN AND PLUG SCREW FEEDER ①

- Vibrating discharger with center steaming
- PRS plug screw
- AdvaProtect segments – for compression housing
- PRS bearing unit
- PRS inlet housing
- PRS motor gearbox and couplings
- Radar level control



DISCHARGER AND AGITATOR ②

- Plus bushing
- Agitator blade
- Discharge screw and shaft sleeve
- Discharge screw bearing unit
- Discharge screw mechanical seal upgrade

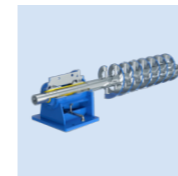

RIBBON FEEDER ③

- Ribbon feeder screw and shaft sleeve
- Ribbon feeder bearing unit
- Ribbon feeder mechanical seal upgrade

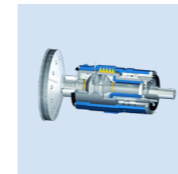

REFINER ④

- PR refiner bearing units and refurbishments
- Lubrication upgrades
- ABS ANDRITZ bearing solution
- PR plate holder
- PR rotor disc
- Couplings
- Main motor
- Mechanical seal
- Sealing water panel
- Lubrication panel

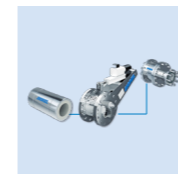

BLOW LINE ⑤

- ANDRITZ finger blow valve FBV
- ANDRITZ fiber diverter valve FDV

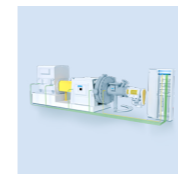

AUTOMATION UPGRADES

- Hydraulic commander
- AdvaCon
- MDF Eye
- Digital wood

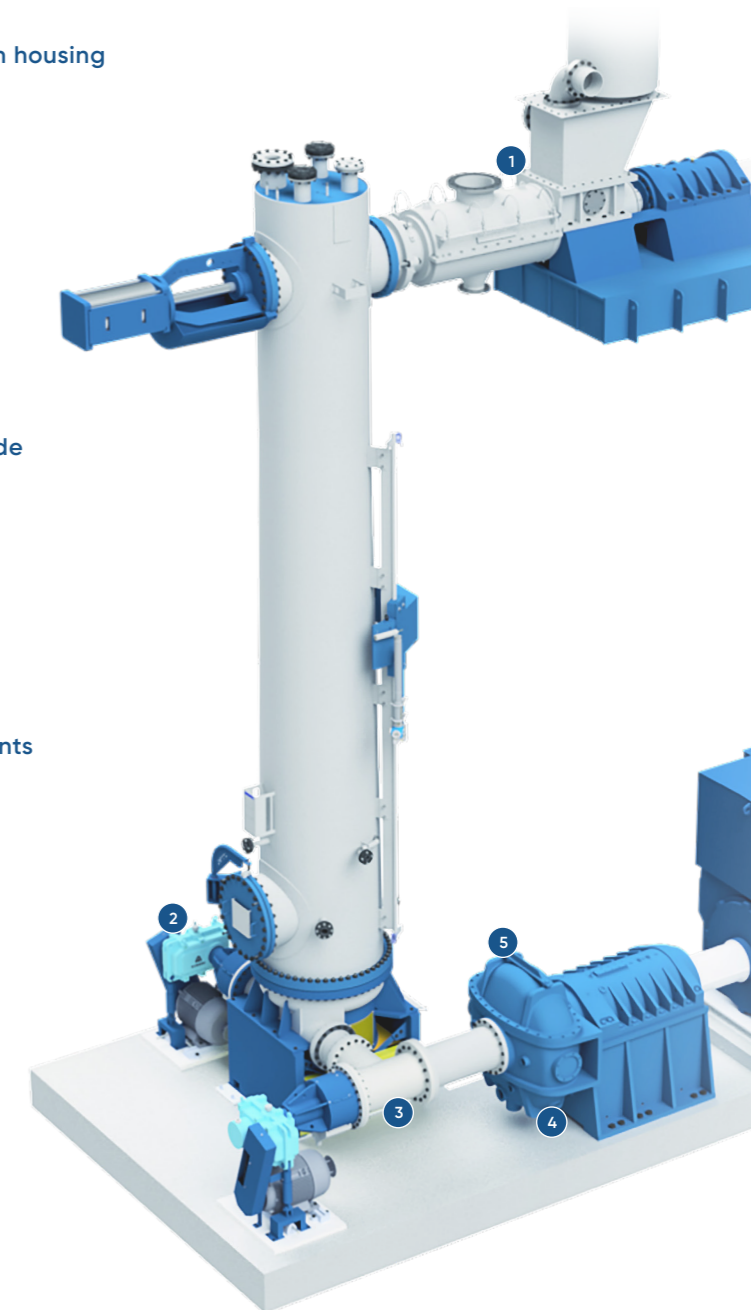

Pre-steaming bin and plug screw feeder

Plug screw feeders transport raw materials from atmospheric conditions to the pressurized zone of the process. ANDRITZ offers rebuilds, spare and wear parts, upgrades, and on-site services for the entire equipment.

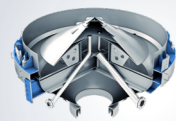
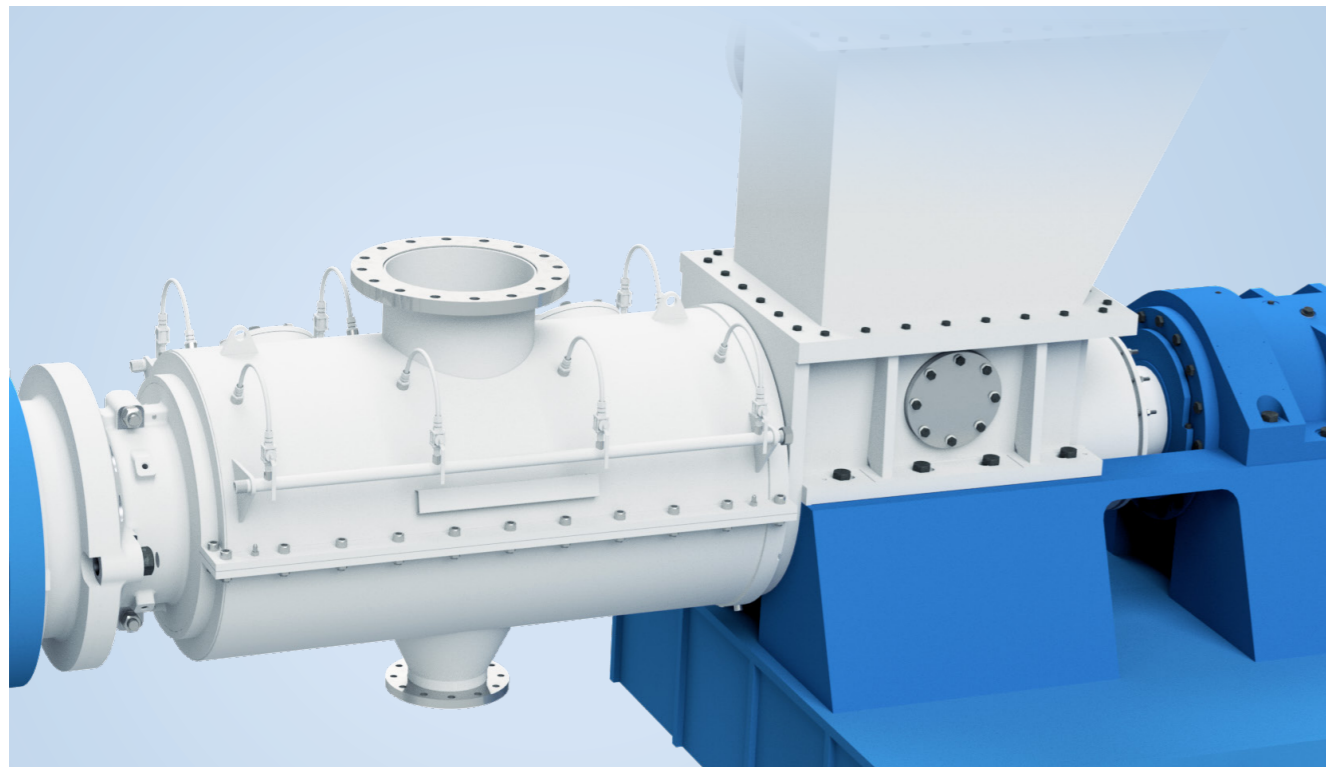

ANDRITZ vibrating discharger with center steaming

Center steaming design for pre-steaming bins

- First-in, first-out principle for uniform wood chip retention time
- Even temperature and moisture distribution by ANDRITZ center steaming system
- No risk of bridging or blocking

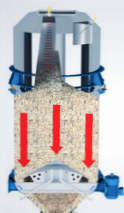

Radar level control for pre-steaming bin

Radar level control sensor on top of the pre-steaming bin for exact level measurement

- Optimized use of the pre-steaming bin
- Easy to retrofit to existing equipment
- Better pre-steaming results



ANDRITZ PRS plug screw

A new generation of plug screws

- Premium casting quality and screw shape accuracy
- Manufacture of new screws and refurbishment in local ANDRITZ workshops (e.g. Austria, Turkey, China, Canada)
- ANDRITZ AdvaProtect 70 hardfacing for maximum wear resistance and longest lifetime
- Customized screw designs to achieve maximum performance (motor load, dewatering, lifetime)

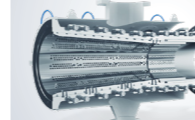

AdvaProtect segment housing (APS)

Innovative solution for on-site refurbishment with exchangeable wear segments

- Extremely wear-resistant inserts (segments) for maximum lifetime
- Fast replacement on site, reduced transport costs and no more investments for new compression housings and/or spools
- Maximum dewatering on request for reduced digester steam and dryer energy costs
- Maximum flexibility (compression adjustable on site) with replaceable, customized wear inserts.

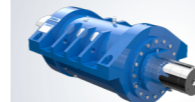

PRS bearing unit

PRS plug screw feeder bearing units available for all sizes, from 13.5" to 24"

- Delivery of new PRS bearing units
- Repair of existing PRS bearing units and delivery of all possible spare parts required
- Main shaft design with exchangeable stuffing box wear sleeve on request

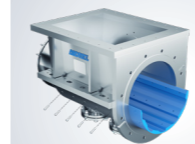

PRS inlet housing with exchangeable wear liner

Efficient maintenance and dewatering on request

- Best price-performance ratio
- Top quality, longest lifetime and highest reliability
- Exchangeable wear liner, no welding repairs or investments in new inlet housings

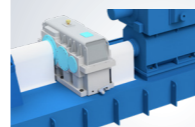

PRS motor, gearbox and couplings (drive train)

- Supply of any kind of spare motors, gearboxes and couplings (low-speed and high-speed)
- Upgrade of existing, outdated DC motors to AC motors with frequency converter
- Increase in motor power for capacity upgrades and improved dewatering



Blow back valve for PR refiner systems

Proven ANDRITZ design also for PRS plug screw feeder

- Lower risk of bending, breakage or shaft blockage
- State-of-the-art pneumatic control system
- Maximum safety in combination with maintenance-friendly design

Discharger and agitator

PR refiner side-entry feeding systems consist of a discharge screw and a ribbon feeder. Both screws and the associated bearing units are of crucial importance to ensure a constant feed from the digester to the refiner. This minimizes fluctuations in the refiner motor load and, therefore, ensures a smooth fiber quality in combination with lowest SEC (specific energy consumption).



	<p>Plus bushing – for agitator New, highly wear-resistant bushing</p> <ul style="list-style-type: none"> • Interchangeable with previous OEM bushing • Latest-generation bushing materials • Longer service life
	<p>Low-drag agitator blade design with premium bushing Latest agitator blade design for improved process and reduced wear</p> <ul style="list-style-type: none"> • Available with AdvaProtect 70 hardfacing for longest lifetime • Increased shaft lifetime in combination with ANDRITZ plus bushing • Longer service life for agitator seal (stuffing box or mechanical seal)
	<p>Discharge screw and shaft sleeve New ribbon feeder screws and refurbishments with ANDRITZ AdvaProtect 70 hardfacing</p> <ul style="list-style-type: none"> • Highest raw material quality and manufacturing accuracy • ANDRITZ AdvaProtect 70 hardfacing for maximum lifetime and reliability • Capacity upgrades and customized screws according to plant operation parameters
	<p>Discharge screw bearing unit Alternative solution from leading supplier</p> <ul style="list-style-type: none"> • Proven ANDRITZ design with stronger bearing concept for increased lifetime • Discharge screw can be replaced without dismantling complete bearing unit (ANDRITZ sleeve concept) • Plug-and-play replacement with OEM bearing unit
	<p>Discharge screw LF (low-flow) and ZF (zero-flow) mechanical seal Replacement of outdated stuffing boxes with ANDRITZ mechanical upgrade</p> <ul style="list-style-type: none"> • Proven ANDRITZ mechanical seal design, no more leakage and wear on shaft • Minimum water input, resulting in energy savings in the dryer • Plug-and-play stuffing box replacement supplied together with ANDRITZ sealing water panel

Ribbon feeder (feed screw)

The ribbon feeder moves the raw material continuously to the refiner while allowing the steam produced there to flow in the opposite direction to the material feed and back to the digester.

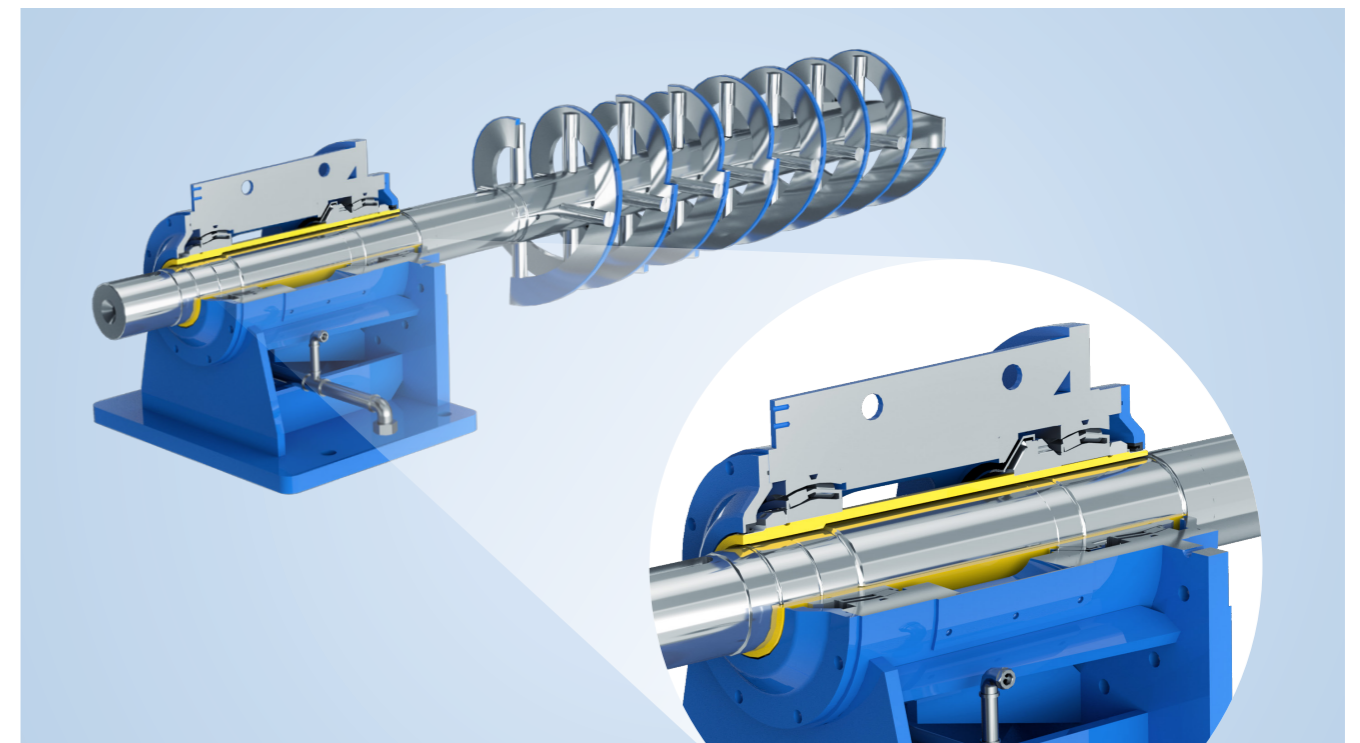

	<p>Ribbon feeder screw and shaft sleeve New ribbon feeder screws and refurbishments with ANDRITZ AdvaProtect 70 hardfacing</p> <ul style="list-style-type: none"> • Highest raw material quality and manufacturing accuracy • ANDRITZ AdvaProtect 70 hardfacing for maximum lifetime and reliability • Customized screws according to plant operation parameters
	<p>Ribbon feeder bearing unit Alternative solution from leading supplier</p> <ul style="list-style-type: none"> • Proven ANDRITZ design with stronger bearing concept for increased lifetime • Ribbon feeder screw can be replaced without dismantling the entire bearing unit (ANDRITZ sleeve design) • Plug-and-play replacement with OEM bearing unit
	<p>Ribbon feeder LF (low-flow) and ZF (zero-flow) mechanical seal upgrade ANDRITZ mechanical upgrades to replace outdated stuffing boxes</p> <ul style="list-style-type: none"> • Proven ANDRITZ mechanical seal design, no more leakage and wear on shaft • Minimum water input, resulting in energy savings in the dryer • Plug-and-play stuffing box replacement supplied together with ANDRITZ sealing water panel

Refiner

The pressurized refiner is the heart of every MDF plant, refining the woods chips to obtain fibers. The refiner is subject to very high loads and, therefore, requires only the best maintenance and refurbishment quality.

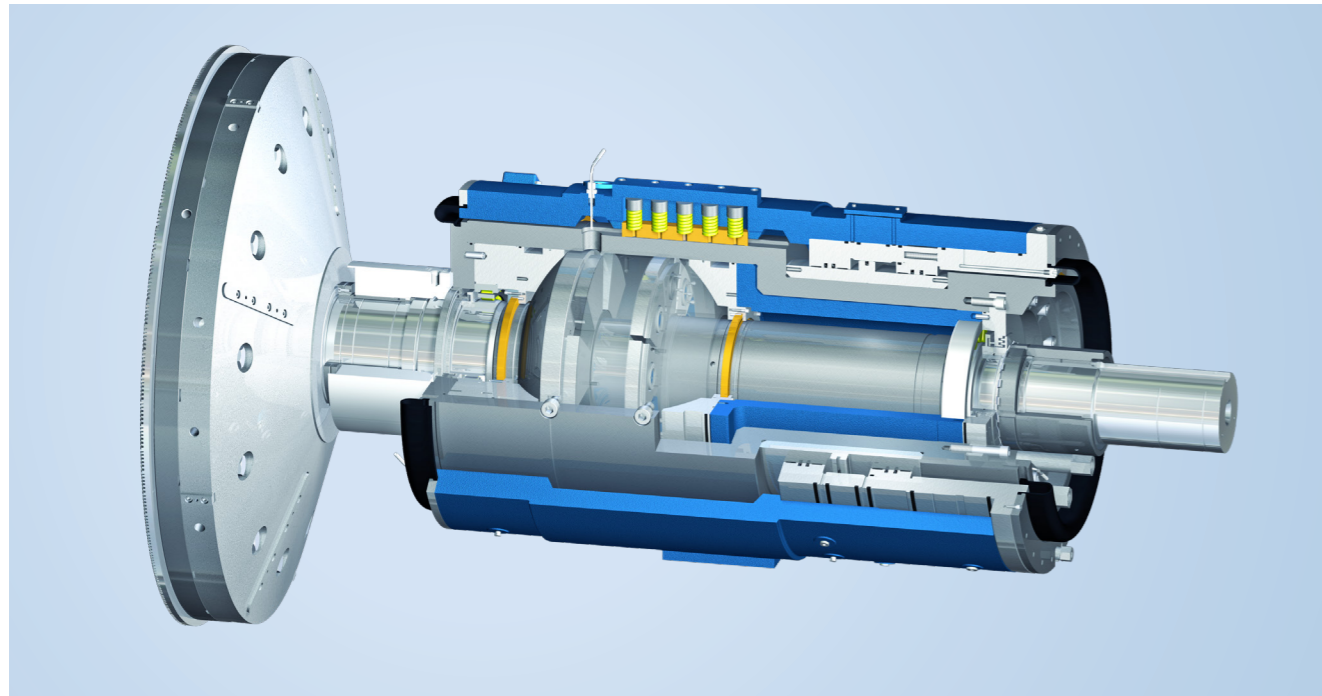
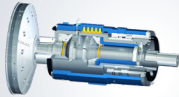
NEW PR refiner bearing units and refurbishments
Implementing several upgrades and resulting in highest lifetime, efficiency and reliability

- High-quality refurbishment, including test run
- Repair and delivery of complete refiner bearing units and all other spare parts
- Flexible service, support, and on-site repairs thanks to global presence and many years of OEM experience



Lubrication upgrade
State-of-the-art upgrade for maximum bearing lifetime

- Upgrade of radial bearing lubrication in PR refiner bearing units
- Increased lifetime and reliability
- No modifications required to existing hydraulic panels (plug-and-play)

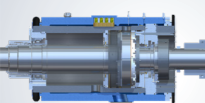

ABS - ANDRITZ bearing solution

- Bearing unit for PR refiners from leading supplier in the market and fully designed by ANDRITZ
- Maximum machine stability, lowest vibration and longest lifetime (10 years +)
- Plug-and-play solution (all other components, including mechanical seal, rotor disc and coupling, can be reused)

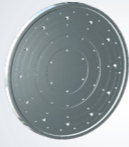

PR plate holder (segment holder)

- Plate holders from 32" to 70", made of ultra-wear-resistant steel
- Highest manufacturing accuracy and balancing for maximum refiner stability
- Can be delivered with ANDRITZ Premium dovetail scrapers for less wear on outer diameter (OD)

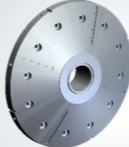

PR rotor disc

- Rotor discs from 32" to 70", made of ultra-wear-resistant steel
- Highest manufacturing accuracy and balancing for maximum refiner stability
- Can be delivered with ANDRITZ Premium dovetail scrapers for less wear on OD and ventilation ring for less wear on the rear side between disc and mechanical seal

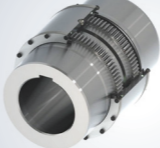

Couplings

- On-site inspection and condition check for existing couplings
- Highest-quality spare couplings (motor and refiner sides)
- Intermediate shaft between refiner and main motor

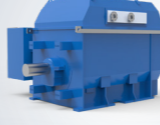

Main motor

- All types of refiner motors supplied as spare parts
- Retrofit of main motors no longer available from market sources
- Upgrade of bearing design for increased lifetime and reliability



Mechanical seal

- Spare mechanical seals for all refiner sizes
- Upgrades of small PR refiners, from stuffing box to mechanical seal
- On-site support for replacement of mechanical seals



Sealing water panel for existing mechanical seals
Existing OEM panels replaced with state-of-the-art ANDRITZ sealing water panel

- ANDRITZ sealing water panel with water flushing and emergency tank (in case of power failure)
- Longer lifetime and highest reliability of mechanical seals
- Uses soft water instead of demineralized water



Lubrication panel
ANDRITZ lubrication panel for PR refiners

- State-of-the-art lubrication panel with highest quality hydraulic parts
- Double filter station, flow and pressure monitoring, and connection to customer PLC
- Available in "Advanced" and "Premium" versions, including automatic oil quality and moisture content measurement and monitoring

Blow line - FBV and FDV from ANDRITZ

The finger blow valve (FBV) with ANDRITZ crashbox is specially designed to regulate the fiber flow in a way that is suitable for a blow line. Furthermore, it reduces turbulence to a minimum and improves lifetime and operating availability. The clever design enables easy exchange of individual wear parts like the sleeves or fingers.

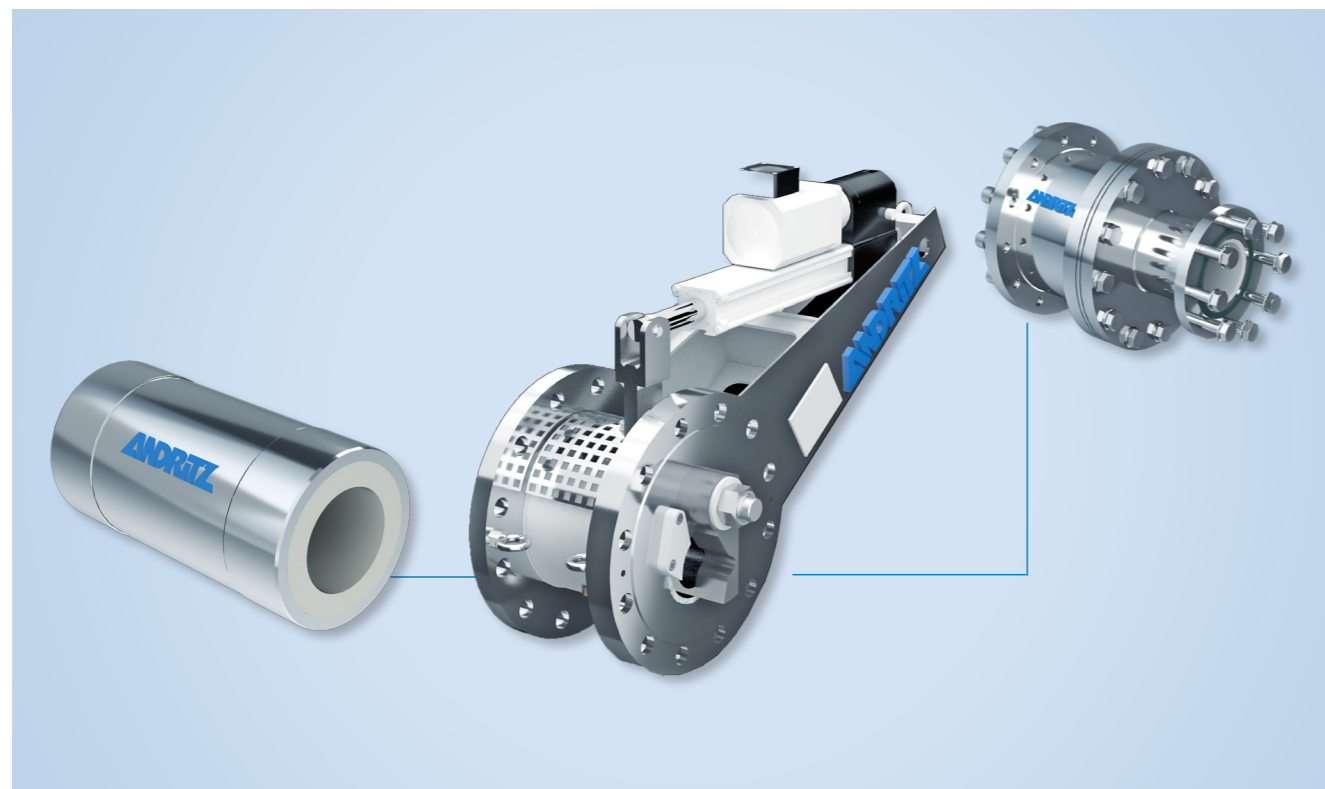
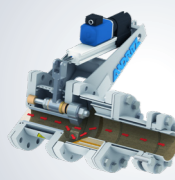
Finger blow valve (FBV) with crashbox
Outstanding design that is subject to a constant improvement process based on detailed process knowledge

- No jamming or blocking of finger, maintenance-free electromechanical drive
- ANDRITZ crashbox to protect the blow line after the FBV
- Available with ceramic sleeve and finger with ceramic plate for maximum lifetime and reliability





Fiber diverter valve (FDV)
Highly reliable and fail-safe design

- Reduced maintenance costs due to fewer wear parts, compact design, and lubrication-free slide bearings
- Less wear and flow turbulence
- Highly reliable operation because valve components are not restricted in their movement

Automation upgrades

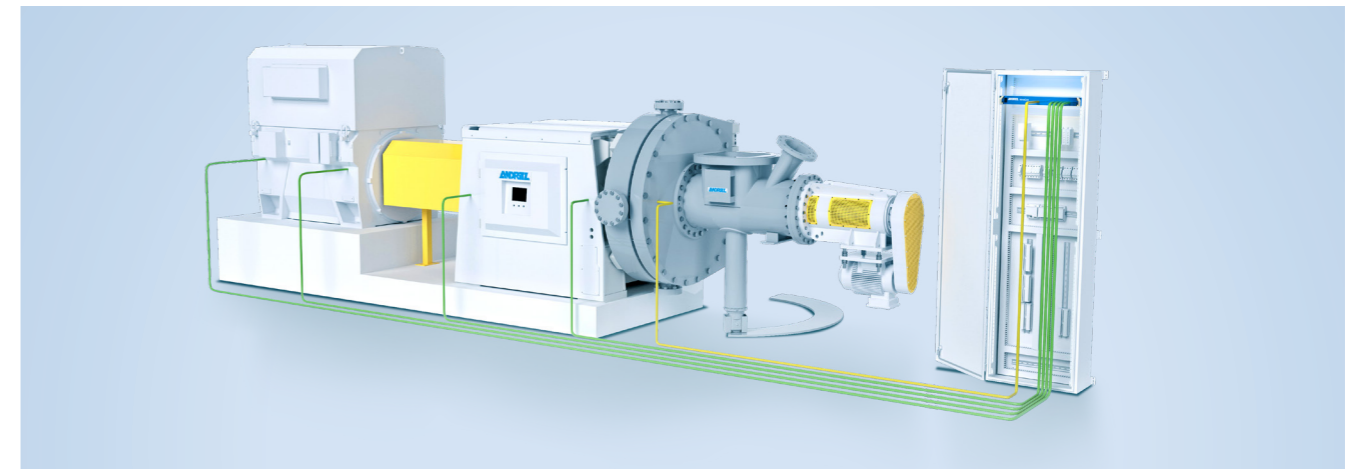
Whether it is the fully autonomous control system with a specially designed sensor for our customers' refiners or our solutions for monitoring the health of other rotating equipment, we present regular ANDRITZ automation and digitalization updates to optimize your system.

Hydraulic commander
Flexible solutions for fully automatic refiner control

- Fully autonomous monitoring and control system for refiners
- Hydraulic control block with servo valve for optimum refiner plate positioning
- Control of the refiner plate's position and/or closing pressure, allowing operators to control refiners remotely



AdvaCon – predictive maintenance
Automatic refiner plate protection and bearing condition monitoring

- Available for all refiner types independent of the OEM
- Cost reductions: Avoid unplanned shutdowns, optimize preventive maintenance schedule
- Accuracy: providing consistent and exact dynamic zeroing of plate gap



MDFEye
Measuring device designed to measure the fiber quality at the blow line continuously

- Production monitoring and determination of fiber properties after the refining process
- Automatic, fast and reliable fiber measurement results
- Enhancing energy-saving potential in MDF production
- Sampling possible from multiple refiners



Digital wood
Measuring the wood quality by tracing/detecting and monitoring key properties of the incoming raw material. ANDRITZ instruments measure moisture and temperature with a measuring sensor, volume with a laser scanner and weight with a conveyor belt.

- Control of the material infeed to monitor its stability
- Process control and claim management
- Technological monitoring



TO DISCOVER THE BEST SOLUTIONS FOR YOUR NEEDS, PLEASE CONTACT YOUR RESPECTIVE KEY ACCOUNT MANAGER

We also want to take up your challenges! For more information about ANDRITZ's services, please visit andritz.com/refiner-service for details.

EUROPE

ANDRITZ AG
Vienna, Austria
p: +43 50805-0

SOUTH AMERICA

ANDRITZ Brasil Ltda.
Curitiba, Brazil
p: +55 41 2103-7601

JAPAN

ANDRITZ K.K.
Tokyo, Japan
p: +81 (3) 3536 9700

NORTH AMERICA

ANDRITZ Ltd.
Brantford, Canada
p: +1 519 754-4590

CHINA

ANDRITZ (China) Ltd.
Foshan, China
p: +86 757 8296 9222

panelboardservice@andritz.com

ANDRITZ

All data, information, statements, photographs and graphic illustrations in this leaflet are without any obligation and raise no liabilities to or form part of any sales contracts of ANDRITZ AG or any affiliates for equipment and/or systems referred to herein. © ANDRITZ GROUP 2022. All rights reserved. No part of this copyrighted work may be reproduced, modified or distributed in any form or by any means, or stored in any database or retrieval system, without the prior written permission of ANDRITZ AG or its affiliates. Any such unauthorized use for any purpose is a violation of the relevant copyright laws. ANDRITZ AG, Stattegger Strasse 18, 8045 Graz, Austria.