

Newport Medical Instruments, Inc.

# **NEWPORT HT50 VENTILATOR**

---

## **Service Manual**

**SERHT50 Rev. B**

**06/01**

**(for p/n HT50-H, HT50-H1 and HT50-T)**

**NEWPORT  
NMI**



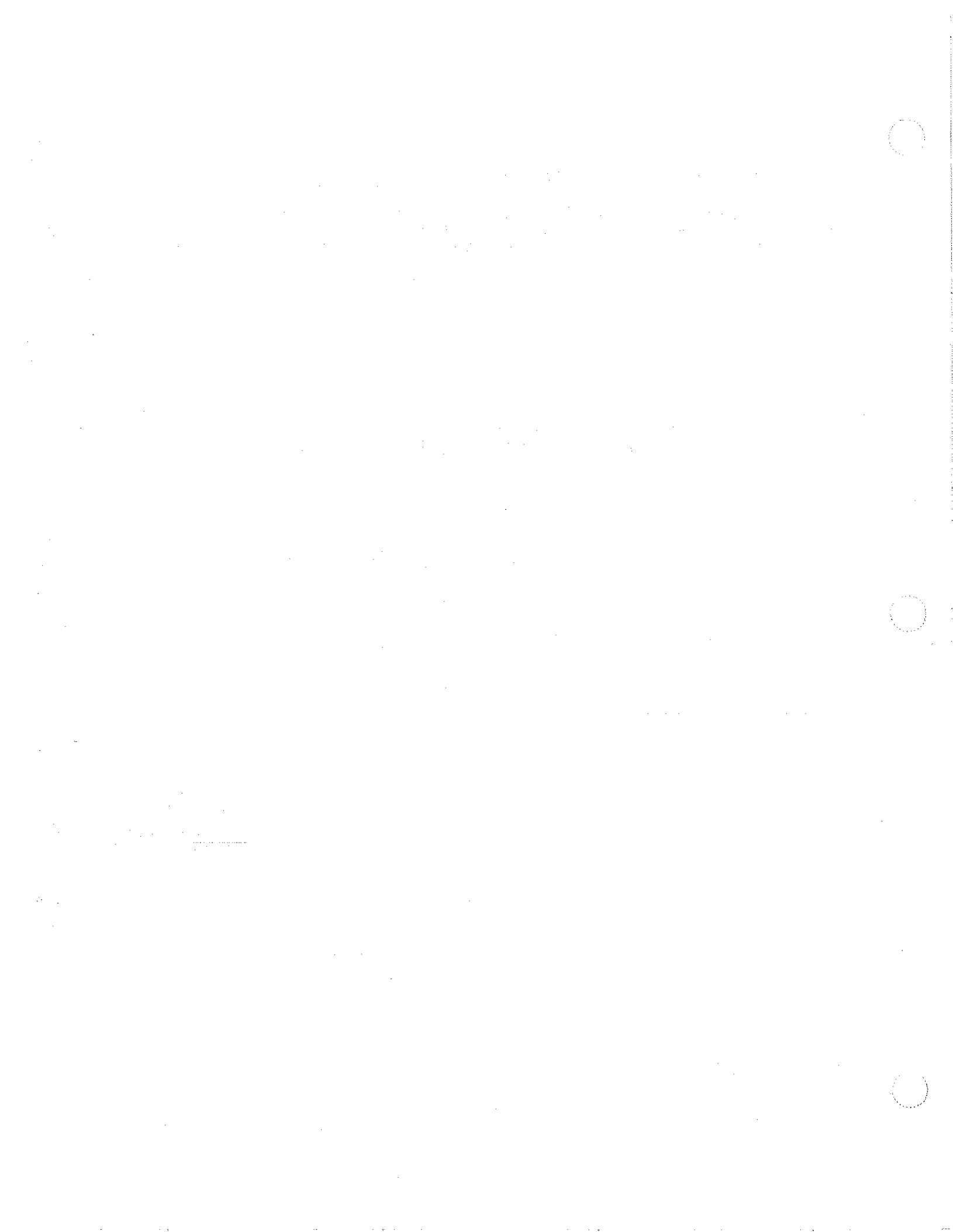
Manufactured by Flight Medical, Ltd.  
13 Hamelacha, Lod, 71520 Israel  
exclusively for:

Newport Medical Instruments, Inc.  
Post Office Box 2600  
Newport Beach, CA 92658 USA  
Tel: 800.451.3111 949.642.3910  
Fax: 949.548.3091  
Customer Service ext. 282  
Technical Service ext. 500

**EU REPRESENTATIVE:**  
Newport Medical Instruments  
Att: Robert Brink  
Barton-on-Humber  
18 Pasture Rd.  
South Humberside  
DN18 5HN, England

Tel: 44.4682.31311  
Fax: 44.1652.633399

[www.NewportNMI.com](http://www.NewportNMI.com)  
email: [Customers@NewportNMI.com](mailto:Customers@NewportNMI.com)



---

# TABLE OF CONTENTS

## **Section 1** ..... OPERATOR'S RESPONSIBILITY

- Operator's Responsibility for Patient Safety
- Limitation of Liability
- Warranty
- Definitions
- Typing Conventions
- Warnings and Cautions
- Factory Maintenance or Repair
- Contact Information

## **Section 2** ..... SPECIFICATIONS

- Intended Use
- Symbols / Labeling Table
- Controls / Alarms / Monitors
- Hardware Requirements
- Miscellaneous Specifications
- Humidifier Specifications
- Air / Oxygen Entrainment Mixer Specifications
- Oxygen Blending Bag Kit Specifications

## **Section 3** ..... DESCRIPTION OF CONTROLS, INDICATORS, ALARMS & CONNECTORS

- Front Panel Overview
- Front Panel Controls & Indicators
- Front Panel Alarms
- Front Panel Message Display Window
- Left Side Connectors
- Right Side Connectors
- Optional Accessories
- User Set Up

---

**Section 4** ..... THEORY OF OPERATION

- General System Overview
- A/CMV Mode (Assist/Control Mandatory Ventilation)
- SIMV Mode (Synchronized Intermittent Mandatory Ventilation)
- SPONT Mode (Spontaneous Ventilation)
- P support (Pressure Support)
- Pressure Control Ventilation
- Volume Control Ventilation
- Back-Up Ventilation

**Section 5** ..... CALIBRATION / OPERATIONAL VERIFICATION PROCEDURE

- Introduction
- Test Equipment Required
- Pre-Test Inspection
- Front Panel Test / Alarm Check
- Pressure Transducer Calibration
- Pressure Meter Calibration
- Volume Factor Calibration
- Pressure Relief Valve Calibration
- Exhalation Valve Calibration
- Operational Set-Up (Standard Test Settings)
- Pressure Verification
- P trig
- PEEP / CPAP
- Manual Inflation
- Respiratory Rate
- Inspiratory Time
- High Paw Alarm
- Low Paw Alarm
- High Minute Volume Alarm
- Low Minute Volume Alarm
- Check Prox Line Alarm
- Apnea Alarm
- Battery Test
- Humidifier (for HT50-H)
- OVP Test Record

**Section 6** ..... 10,000 HOUR MAINTENANCE PROCEDURE

- Introduction
- Inspection of Ventilator
- Replacement of Assemblies
- Replacement of Pump Assembly
- Replacement of Internal Battery
- Cleaning
- Burn-In Test
- Operational Verification Procedure

---

**Section 7** ..... TROUBLESHOOTING INSTRUCTIONS

- Introduction
- Troubleshooting

**Section 8** ..... ELECTRONIC & PNEUMATIC COMPONENT REMOVAL  
AND REPLACEMENT PROCEDURES

- Introduction
- Tools Required
- Disassembly (Lower Case)
- Reassembly (Lower Case)
- Internal Battery
- Pump Assembly
- Outlet Assembly
- Humidifier Heater Assembly
- Front Panel Assembly
- Main Board Assembly
- Power Supply Board

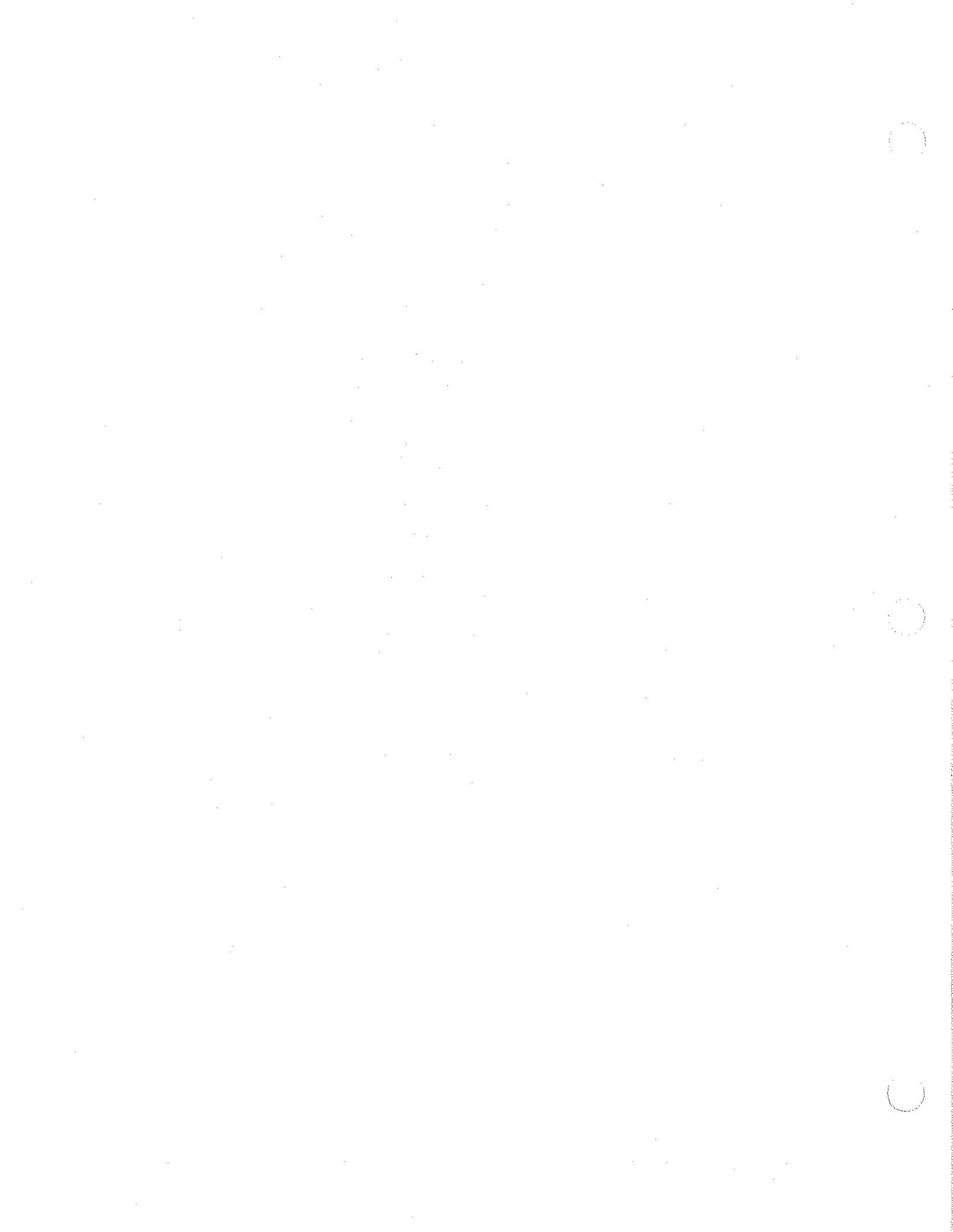
**Section 9** ..... DIAGRAMS AND PARTS LISTS

- Figure 1, Internal View
- Figure 2, Final Assembly, Front View HT50-H
- Figure 3, Final Assembly, Front View HT50-T,  
HT50-H1
- Figure 4, Main Board with Mounting Hardware
- Figure 5, Main Board Tubing Connection, Left Side
- Figure 6, Right Side Case
- Figure 7, Front Panel, Side View
- Figure 8, Pneumatic Schematic
- Drawing Part Numbers Reference List

**Section 10** ..... REPACKAGING AND SHIPPING INSTRUCTIONS

- Introduction
- RGA (Return Goods Authorization)
- Packaging: Complete Unit
- Packaging: Parts or Accessories

**Appendix A** ..... HT50 ACCESSORIES



---

# 1. OPERATOR'S RESPONSIBILITY

Operator's Responsibility for Patient Safety . . . . .	1-1
Limitation of Liability . . . . .	1-2
Warranty . . . . .	1-2
Definitions . . . . .	1-3
Typing Conventions . . . . .	1-4
Warnings and Cautions . . . . .	1-4
Factory Maintenance or Repair . . . . .	1-7
Contact Information . . . . .	1-7



---

**OPERATOR'S RESPONSIBILITY FOR PATIENT SAFETY**

This Service manual contains information intended to ensure safe and effective ventilator calibration, maintenance and repair. It is mandatory that service personnel working on the Newport HT50 ventilator carefully read and observe all sections of this manual to avoid potential hazards.

The Operation manual (p/n OPRHT50-1) contains information intended to ensure safe and effective ventilator use. The label on the inside of the front panel cover door is meant to complement not replace the Operation manual.

The design of the HT50 ventilator, the Operating and Service manuals, and the labeling on the ventilator take into consideration that the purchase and use of the equipment is restricted to trained professionals, and that certain inherent characteristics of the ventilator are known to the operator. Instructions, warnings and caution statements are therefore limited to the specifics of the Newport HT50.

**WARNING** Federal law restricts this device to sale by or on the order of a physician.

This manual excludes references to various hazards which are obvious to medical professionals and operators of this equipment, to the consequences of product misuse, and to potentially adverse effects in patients with abnormal conditions.

When the HT50 is used in home care and sub acute environments it is important that the primary caregiver has received training and has demonstrated competency in all equipment functions. A specific written care plan must be established by the attending physician.

Transport of patients with the HT50 requires that medical staff have a good working knowledge of the ventilator's use and problem resolution. Proper emergency back-up equipment must be immediately available during transport.

**NOTE:** The HT50-T ventilator is the only version of the HT50 Ventilator that has been tested and approved for use in transport applications.

HT50 operators must recognize their responsibility for implementing safety monitoring mechanisms which supply appropriate information on equipment performance and patient condition. Patient safety may be achieved through a wide variety of means such as electronic surveillance of equipment performance and patient condition. However, equipment surveillance should not replace direct observation of clinical signs. The HT50 operator is solely responsible for selecting the appropriate level and method of patient monitoring.

## **OPERATOR'S RESPONSIBILITY**

---

Product modification or misuse can be dangerous. Newport Medical Instruments, Inc. (NEWPORT) disclaims all liability for the consequences of product alterations or modifications, as well as for the consequences which might result from the combination of this ventilator with other products, whether supplied by Newport or by other manufacturers, unless such a combination has been specifically endorsed by Newport.

## **LIMITATION OF LIABILITY**

The liability of Newport Medical Instruments, Inc. (NEWPORT) is subject to and limited to the exclusive terms and conditions as set forth herein. Said liability is limited whether arising out of, or related to, the manufacture and sale of goods, their installation, demonstration, sales representation, use, performance, or otherwise. Any liability based upon product warranty, whether breach of warranty or otherwise, is limited regardless of any fault attributable to NEWPORT and the nature of the action (including breach of warranty, negligence, and strict liability).

The expressed warranties are in lieu of all other warranties, expressed or implied, including, without limitation, warranties of merchantability, fitness for any purpose, or noninfringement.

NEWPORT shall not be liable for any special incidental or consequential damages incurred by the buyer to a third party. The buyer shall not be entitled to make liability recoveries from NEWPORT due to such situations.

## **WARRANTY**

The Newport HT50 Ventilator is guaranteed to be free of defects for a period of two (2) years from date of delivery. The following are exceptions to this warranty:

1. Defects caused by misuse, mishandling, tampering, or by modifications not authorized by Newport Medical Instruments, Inc. (NEWPORT) or its representatives.
2. Rubber and plastic components and materials are guaranteed to be free of defects at time of delivery.

Any product which proves to be defective in workmanship or material will be replaced, credited, or repaired. Newport retains the discretion to select the most suitable of these options. Newport is not responsible for deterioration, wear, or abuse. In all cases, Newport will not be liable beyond the original selling price.

Application of this warranty is subject to the following conditions:

1. NEWPORT or its authorized representatives must be promptly notified upon detection of the defective material or equipment.
2. Defective material or equipment must be returned to NEWPORT or its authorized representative.
3. Examination by NEWPORT or its authorized representatives must confirm that the defect is covered by the terms of this warranty.

To ensure complete protection under this warranty, the Warranty Registration Card must be returned to Newport within ten (10) days of equipment receipt.

The above is the sole warranty provided by NEWPORT. No other warranty, expressed or implied, is intended. Representatives of Newport are not authorized to modify the terms of this warranty.

**NOTE:** The serial number label is located on the rear of the ventilator. If it is a seven digit serial number, the ventilator's year of manufacture is stated in the third and fourth digits of the number series; the month is indicated by the first and second digits and the last three digits are the consecutive numbers. For example: SN 0499123 – the ventilator was manufactured in April 1999. If it is an eight digit serial number, the manufacturing year is stated in the first and second digit, the month is the third and fourth digits and the last four digits are the consecutive numbers. For example: SN 00020123 – the ventilator was manufactured in February 2000.

## DEFINITIONS

■ **WARNING** Possibility of personal injury, to patient or others, if disregarded.

■ **Caution** Possibility of equipment damage if disregarded.

**NOTE:** Additional information intended to avoid inconveniences during operation. Notes also indicate important procedures to be followed.

**Inspection:** Examination of actual condition.

**Service:** Measures required to maintain a specified condition.

**Repair:** Measures required to restore a specified condition.

**Maintenance:** Required inspection, service, and repair of the device.

**Preventive Maintenance:** Maintenance performed at regular intervals to keep the device in good working condition.

# OPERATOR'S RESPONSIBILITY

---

## TYPING CONVENTIONS

Within the text of this manual, controls, alarms, and indicators are designated by the labeling name as they appear on the ventilator, e.g.: P support (pressure support), P trig (pressure trigger), and SPONT (spontaneous mode).

Please review all **WARNINGS** and **Cautions** outlined in this manual prior to servicing the HT50 for the first time.

## WARNINGS AND CAUTIONS

At all times, strictly follow this Service Manual. The safe use of the HT50 Ventilator requires a full understanding of its operation and adherence to the manual's instructions. The equipment is only to be used for the purpose specified under "Intended Use" (see Section 2). Observe all of the **WARNINGS** and **Cautions** posted in this manual and on labels found on the HT50 Ventilator and associated accessories.

### General Warnings

External power connection: To maintain grounding integrity when using A.C. power, only connect to hospital grade receptacles. Always disconnect the external power supply prior to servicing. Make certain the power cord ferrite is always attached to the A.C. power cord to ensure that the HT50 meets EMC requirements.

**WARNING** There is a risk of explosion if used in the presence of flammable anesthetics.

All settings and adjustments in the different ventilation modes must be made in accordance with a physician's prescribed therapy.

NEWPORT cannot warrant or endorse the safe performance of third party humidifiers for use with the HT50.

When the HT50 is operating on battery power, the optional built-in humidifier does not function. A heat moisture exchanger, or other humidification device, should be used until the unit is connected to A.C. power at which time the built-in humidifier can be used.

Do not use electrically conductive patient circuits.

Always use a clean, sterile patient circuit.

Always use an inline filter (p/n HT6004701 or equivalent) at the Airway Pressure Connector to protect the internal transducers from moisture or other contaminants.

The ventilator is ready for operation only when:

- a) It is completely assembled, and;
- b) The Quick Check Procedure (see Appendix A, Operating Manual) or OVP (Service Manual) has been successfully completed.

Constant attention by qualified medical personnel is recommended whenever a patient is ventilated with the HT50.

When the HT50 is used in homecare environments, proper education and training of the appointed caregiver must be provided prior to the patient leaving the health care facility.

If a fault is detected in the ventilator and its life support functions are in doubt, immediately discontinue use; use an alternative method of ventilation until the fault has been corrected. Contact NEWPORT Technical Service Department immediately.

Failure to identify and correct alarm violations may result in patient injury.

**WARNING** Continuous oxygen monitoring is required for patient safety. The HT50 does not have a built-in alarm system to notify user of a failure or disconnection of the oxygen source.

Ensure that the oxygen source is not empty before and during the use of the optional Air/Oxygen Entrainment Mixer or Oxygen Blending Bag Kit.

When the HT50 is used for transport applications, ensure that the internal battery is fully charged prior to use.

When the Battery Empty audible alarm sounds continuously, less than 30 minutes of internal battery power remains and an alternate power source should be found immediately.

Frequent deep discharge of the internal battery will decrease the amount of time the HT50 will operate on battery power from a full charge state.

Charge the battery for a minimum of 5 hours before powering the ventilator from the internal battery. This will provide approximately 80% of the battery charge. If the battery is completely depleted, it will take approximately 7 to 8 hours to fully recharge.

The internal battery should be used or discharged and recharged at least once every 6 months to ensure it remains functional.

The flow resistance of the air inlet filter, located on the right side of ventilator, is likely to increase with repeated use. Ensure that the filter is changed regularly.

## OPERATOR'S RESPONSIBILITY

---

The HT50 Ventilator is guaranteed to perform to specification when the Newport HT50 breathing circuit with exhalation valve is used. See Appendix A for circuit configurations and parts list.

Only a NEWPORT approved exhalation valve (i.e.: p/n HT600039) can be used with the HT50.

The exhalation valve must be calibrated before its initial use and then again each time it is put into use after cleaning/sanitizing.

### Cautions

Only use medical grade oxygen with the Air/Oxygen Entrainment Mixer or Oxygen Blending Bag Kit.

Do not place liquid containers in the immediate vicinity or on top of the HT50. Liquids that get into the ventilator can cause equipment malfunction and damage.

After servicing an HT50, it must completely pass an Operational Verification Procedure (Section 5) before being returned to patient use.

An authorized Newport Medical Instruments factory-trained technician must do all service or repairs performed on the HT50.

Do not open the ventilator or perform service on an open unit while connected to external power.

Use standard anti-static techniques while working inside the ventilator or handling any electronic parts.

Clean all external parts of the ventilator prior to servicing.

Water in the oxygen supply can cause equipment malfunction and damage.

Always replace a blown fuse with one of proper rating for corresponding voltage range.

**NOTE:** Review HT50 Operating Manual and Theory of Operation (Section 4 of this manual) before servicing the ventilator.

**NOTE:** Use the tools and equipment specified in this manual to perform specific procedures.

Batteries contain corrosive acid and lead. Do not discard them in an incinerator or force them open. Batteries cannot be disposed of with normal waste.

---

**FACTORY MAINTENANCE OR REPAIR**

Scheduled maintenance or repair services are available from the NEWPORT Technical Service Department. To send your ventilator in for service, see Section 10 for repackaging and shipping instructions.

Current pricing for scheduled maintenance and labor rates can be found in Newport Medical Instruments Annual Price List. To obtain a copy of the Price List, please contact your local NEWPORT Sales Representative or call, fax or email our Customer Service Department using contact information that follows:

**CONTACT INFORMATION**

Address: Newport Medical Instruments, Inc.  
Post Office Box 2600  
Newport Beach, California, USA 92658

Courier Deliveries: Newport Medical Instruments, Inc.  
760 West 16th Street, Building B  
Costa Mesa, California, USA 92627

Phone Numbers: 800.451.3111 Toll free within USA  
949.642.3910 Worldwide

Fax Number: 949.548.3091 Worldwide

[www.NewportNMI.com](http://www.NewportNMI.com)  
email: [TechSupport@NewportNMI.com](mailto:TechSupport@NewportNMI.com)

Department Extensions:  
Customer Service Department: 282  
Technical Service Department: 500 (24 Hour pager)  
Clinical Support: 123 (24 Hour pager)  
Domestic Sales Department: 219  
International Sales Department: 219

Corporate Office Hours:  
Monday through Friday 8:00 to 5:00 p.m., Pacific Time, USA

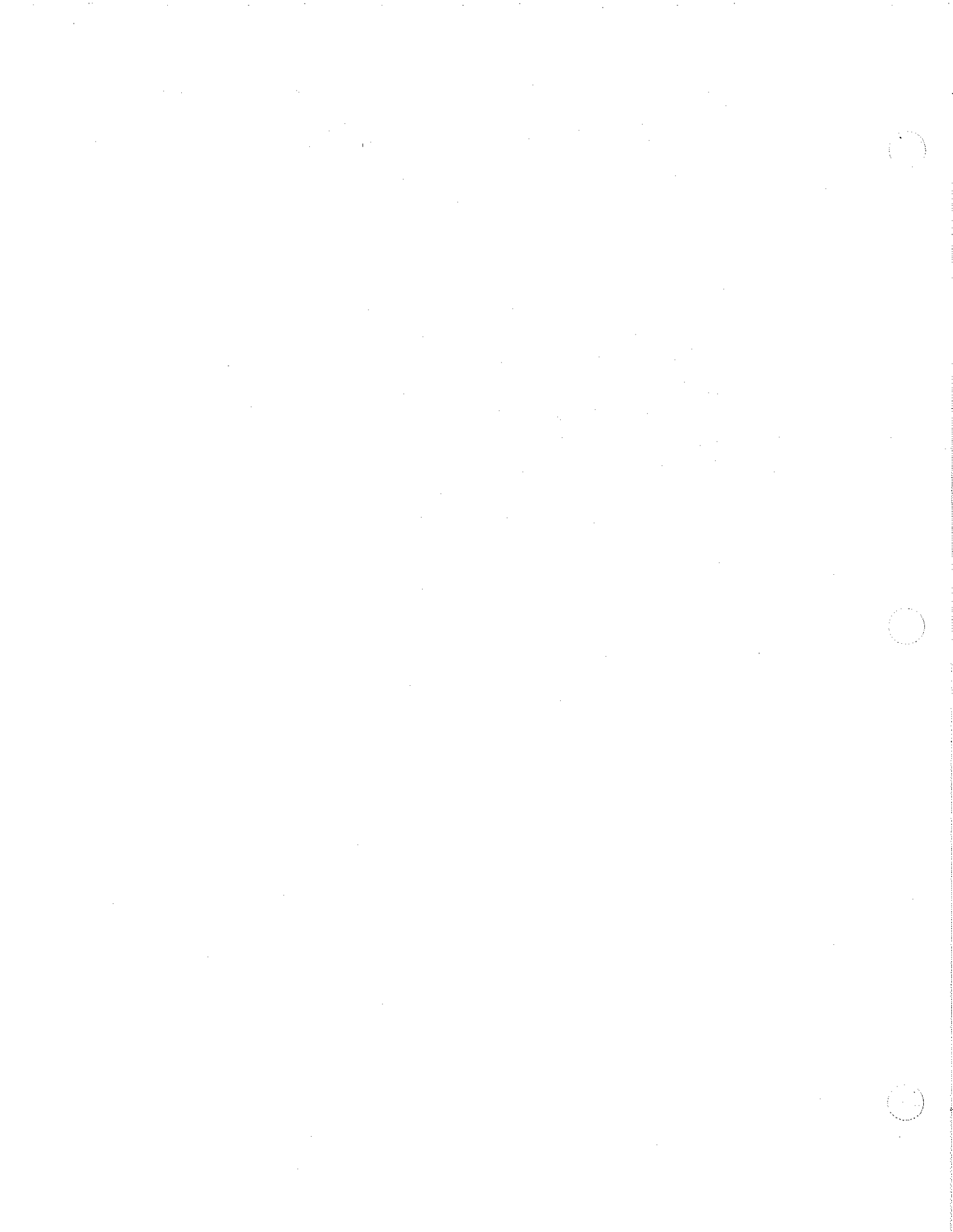
Technical Service Department Hours:  
Monday through Friday 7:00 to 4:00 p.m., Pacific Time, USA



---

## 2. SPECIFICATIONS

Intended Use .....	2-1
Symbols / Labeling Table .....	2-1
Controls / Alarms / Monitors .....	2-2
Hardware Requirements .....	2-5
Miscellaneous Specifications .....	2-5
Humidifier Specifications .....	2-7
Air / Oxygen Entrainment Mixer Specifications ..	2-7
Oxygen Blending Bag Kit Specification .....	2-8













**INTENDED USE**

This device is intended to provide continuous or intermittent mechanical ventilator support for the care of individuals who require mechanical ventilation. The ventilator is a restricted medical device intended for use by qualified, trained personnel under the direction of a physician. Specifically, the HT50 is applicable for adult and pediatric patients, greater than 10 kg or 22 lbs., who require the following general types of ventilatory support, as prescribed by an attending physician: positive pressure ventilation and assist/control, SIMV, CPAP modes of ventilation. The HT50 is suitable for use in post-acute, emergency room, home care environments (p/n HT50-H, HT50-H1) and for transport applications (p/n HT50-T). Transport application is only applicable to the HT50-T.


Front panel controls allow trained operators to select between a number of operational modes, pressure support and volume or pressure control. A comprehensive alarm system is built-in to alert the user to violations of set safety limits. When fully charged, the internal battery provides up to 10 hours of power. With its patented, self-contained gas supply source, the HT50 requires no external air compressor.

**SYMBOLS/LABELING TABLE**

	
<b>Main Power On</b>	<b>Alarm Setting</b>
	
<b>Main Power Standby</b>	<b>Audible Alarm Silence/Reset</b>
	 
<b>Equipotentiality</b>	<b>High Alarm      Set High Alarm</b>
	 
<b>Refer to Operating Manual</b>	<b>Low Alarm      Set Low Alarm</b>
	
<b>Applied Parts Type BF</b>	

## SPECIFICATIONS

---

<u>Controls/Alarms/Monitors</u>	<u>Range/Selection</u>
1. <b>MODE (Pressure or Volume Control)</b>	A/CMV SIMV SPONT
2. <b>Volume Control (Tidal Volume)</b>	100 to 2,200 mL, ATPX, $\pm 10\%$
3. <b>Pressure Control (Target Pressure)</b>	5 to 60 cmH <sub>2</sub> O/mbar
4. <b><math>\dot{V}</math> (Flow)</b>	6 to 100 L/min
5. <b><math>t_i</math> (Inspiratory Time)</b>	0.1 to 3.0 sec
6. <b><math>f</math> (Frequency)</b>	1 to 99 b/min
7. <b>P<sub>trig</sub> (Sensitivity)</b>	-9.9 to 0 cmH <sub>2</sub> O/mbar, pressure triggering (Patient Effort Indicator LED blinks once each time the airway pressure reaches the P <sub>trig</sub> setting.)
8. <b>PEEP/CPAP</b>	0 to 30 cmH <sub>2</sub> O/mbar
9. <b>P<sub>support</sub> (Pressure Support)</b>	0 to 60 cmH <sub>2</sub> O/mbar above baseline pressure, limited to PEEP + P <sub>support</sub> $\leq$ 60 cmH <sub>2</sub> O/mbar
10. <b>I:E Ratio</b>	1:99 to 3:1
11. <b>Maximum Limited Airway Pressure (Safety Valve)</b>	100 cmH <sub>2</sub> O (98 mbar)
12. <b>Manual Inflation</b>	3 sec maximum (While button is pushed, the ventilator closes the exhalation valve and delivers a ventilator controlled breath to the patient.)
13. <b>Humidifier (Optional)</b>	19°C to 39°C
14. <b>Airway Pressure Meter</b>	-10 to 100 cmH <sub>2</sub> O / -10 to 98 mbar
15. <b>Silence / Reset</b> 	Silences an audible alarm violation for 60 seconds and resets a latched alarm indicator.
16. <b>ALARMS Indicators</b>	Indicators for violated alarms blink red. When the alarm is no longer violated, the indicator latches (stays lit). Cancel a latched indicator by pressing the Silence/Reset button.
17. <b>RS-232C / RS-485 Interface</b>	8 pin SEMCONN connector. Operates at 19,200 baud. Allows for interfacing with central monitoring and computer systems.
18. <b>External / Battery Input</b>	12-30 Volt D.C. battery input
19. <b>Int. Battery Button</b>	Press to display the internal battery charge level in the airway pressure meter (Paw) window. See pg 3-13 for details.

**Controls/Alarms/Monitors****Range/Selection**

20.  $F_{iO_2}$   
(with optional accessories)

0.21 to 1.00

21. On / Standby Button

Press once to set control parameters (Setting condition).  
Press again to enable ventilation (On condition).  
When the HT50 is ventilating, press two times to put ventilator into Standby/Off condition.

**NOTE:** The internal battery charges whenever the HT50 is connected to an external power source. See item 27.

22. Push To Unlock

Unlocks front panel buttons if locked by automatic panel lock feature. Auto lock can be enabled/disabled in User Set Up.

23. Alarms

▲Paw (High Pressure)

4 to 99 cmH<sub>2</sub>O / 4 to 91 mbar

▼Paw (Low Pressure)

3 to 98 cmH<sub>2</sub>O / 3 to 96 mbar

Low Baseline Pressure

Paw  $\geq$  2 cmH<sub>2</sub>O/mbar <baseline for 3 sec

High Baseline Pressure

Paw > ▼Paw at onset of a time-triggered breath

Occlusion

Paw > PEEP + 15 cmH<sub>2</sub>O/mbar 3 sec after start of expiration

Apnea

30 sec  $\pm$  3 sec

PCV Not Reached

Paw P < 50% of PCV setting

▲ $\dot{V}_I$  Insp. Min. Volume

2 to 50.0 L/min

▼ $\dot{V}_I$  Insp. Min. Volume

0.3 to 49.0 L/min

Check Prox Line

Prox Paw  $\neq$  machine Paw during inspiration

Humidifier (5 messages)

Humidifier malfunction/disconnection

Battery Low

Less than two hours battery charge remains

Battery Empty

Less than 30 minutes battery charge remains

Power Switchover

External power to internal battery switchover alert

Device Alert (4 messages)

Ventilator malfunction

Shut Down Alert

On to Standby/Off Shut Down Alert

Alarm Silence

Silences audible alarm for 60 sec; resets latched LEDs

24. Message Display Window

Up to 16 characters, LED alpha numeric display

Displayed monitored parameters:

$V_T$  (Actual delivered tidal volume)

$\dot{V}_I$  (Inspiratory minute volume)

$f$  (Total breath frequency)

Paw P (Peak airway pressure)

Paw M (Mean airway pressure)

Paw B (Baseline airway pressure)

Other displayed parameters  
(In USER SET UP):

Software Version

Operation Hours

Power Save (On / Off)

Airway Pressure Units (cmH<sub>2</sub>O/mbar)

Language (English)

Shut Down Alert (On / Off)

Buzzer Volume (Loud / Quiet)

# SPECIFICATIONS

---

Other displayed parameters continued  
(In USER SET UP):

Set Up (User / Default)  
Auto Panel Lock (Enabled / Disabled)  
Communication Protocol (Comm RS232 / RS485)  
Meter Adjust (Paw meter needle adjustment to zero position)  
Valve Cal (Exhalation valve calibration)  
Tech. Setup (Technical set up)

## 25. Front Panel Indicators

### Modes

A/CMV Green LED indicates that A/CMV mode is active.  
SIMV Green LED indicates that SIMV mode is active.  
SPONT Green LED indicates that SPONT mode is active.

### Controls

Volume Control Green LED indicates Volume Control ventilation.  
Pressure Control Green LED indicates Pressure Control ventilation.

### Alarms

▲Paw (High Pressure) Red LED indicates high peak airway pressure, high baseline pressure, or occlusion alarm violation.  
▼Paw (Low Pressure) / Apnea Red LED indicates low peak airway pressure, low baseline pressure, apnea, or PCV (50% of PCV setting not achieved) alarm violation.  
Device Alert Red LED indicates ventilator malfunction alert.  
▲ $\dot{V}_I$  (High Insp. Min. Volume) Red LED indicates high inspiratory minute volume setting is violated.  
▼ $\dot{V}_I$  (Low Insp. Min. Volume) (Back-Up Vent) Red LED indicates low inspiratory minute volume setting is violated.

### Misc. Indicators

Silence / Reset Yellow LED indicates that the audible alarm is silenced for 60 seconds.  
Auto Lock On Green LED indicates that the panel is currently locked.  
On / Standby Green LED indicates that ventilator is powered ON.  
Ptrig Green LED blinks on to indicate patient breathing effort.  
 $\dot{V}$  (Flow) Green LED indicates that Flow is displayed in the  $\dot{V}$ /I:E Ratio numeric window display.  
I:E Green LED indicates that the I:E Ratio is displayed in the  $\dot{V}$ /I:E Ratio numeric window display. Blinking LED indicates a breath with an inverse I:E Ratio.  
Ext. Power / Charging Int. Battery Green LED indicates external power is on and the internal battery is being charged. Red LED indicates power switchover to internal battery.  
Int. Battery (Push to Test) Yellow LED indicates internal battery is in use. LED blinks yellow to indicate Battery Low alarm condition or blinks red to indicate Battery Empty alarm condition.  
Humidifier On Green LED indicates humidifier is active. LED blinks yellow to indicate humidifier alarm condition.

**Hardware****26. Electrical****Requirements**

Applied parts type BF  
 100-240 VAC, max. 2 A  
 50 / 60 / 400 Hz  
 12-30 VDC, max. 12 A

**27. Internal Battery**

Sealed Lead Acid, 12 VDC, 5 A  
 When fully charged, supplies power for up to 10 hours of operation (i.e., A/CMV mode,  $f=20$ , Volume Control=500 mL,  $t_i=1.0$  sec, PEEP= $\emptyset$ , max. airway pressure 30 cmH<sub>2</sub>O/mbar, Power Save mode ON).

**NOTE:** The internal battery charges whenever the HT50 is connected to an external power source. Battery charge level is best maintained by keeping the HT50 continuously connected to external power.

**28. Pneumatics**

Gas delivery system requires no external air compressor.

**Miscellaneous****Description****29. Operating Temperature**

-18°C to 50°C

**30. Operating Humidity**

15 to 95% non-condensing

**31. Operating Altitude**

Sea level to 15,000 ft (0 to 4,572 m)  
 There is no altitude limitation when HT50 (HT50-T) is operated in a pressurized environment.

**32. Operating Pressure**

600 to 1,100 mbar

**33. Regulatory and Agency Standards/Requirements (for p/n HT50-H, HT50-H1 and HT50-T)**

Complies with the following international standards and requirements:  
**EC 60601-1** Medical Equipment Standard, 1990  
**IEC 601-2-12** Lung Ventilators, 1988  
**EN60601-1-4** Medical Electrical Equipment, Programmable Electrical Medical Systems, 1996  
**EC 60601-1-2** Medical Electrical Equipment, Collateral Standard & Electromagnetic Compatibility, 1993  
**EN 794-1** Lung Ventilators – Particular Requirements for Critical Care Ventilators, 1996  
**EN 794-2** Lung Ventilators – Particular Requirements for Home Care Ventilators, 1996  
**ISO 10651-1** Lung Ventilators for Medical Use, 1993  
**ISO 10651-2** Particular Requirements for Home Care Ventilators, 1996  
**ISO 10651-3** Particular Requirements for Emergency and Transport Ventilators, 1997 (p/n HT50-T only)  
**ISO 8185** Humidifiers for Medical Use, 1997  
**ASTM F 1100-90** Ventilators for Critical Care, 1990  
**ASTM F 1246-91** Electrically Powered Homecare Ventilators, Positive-Pressure Ventilators and Circuits, 1991

## SPECIFICATIONS

---

34. **Storage Temperature** -40°C to 65°C
35. **Storage Humidity** 0 to 95% non-condensing
36. **Height (includes handle)** 10.24 inches (26 cm)
37. **Width** 10.63 inches (27 cm)
38. **Depth** 7.87 inches (20 cm)
39. **Weight** 15.0 lbs. (6.8 kg) without humidifier  
17.2 lbs. (7.8 kg) with humidifier
40. **Patient Range** Pediatric – Adult (normalized body weight  $\geq$  10 kg)
41. **Factory Default Parameters**

### Patient Settings:

MODE	A/CMV
Volume Control	500 mL
$t_i$	1.0 sec
$f$	15 b/min
P <sub>trig</sub>	-1.0 cmH <sub>2</sub> O
Paw Alarms	5 cmH <sub>2</sub> O $\nabla$ Paw 40 cmH <sub>2</sub> O $\blacktriangle$ Paw
$\dot{V}_i$ Alarms	3 L/min $\nabla\dot{V}_i$ 20 L/min $\blacktriangle\dot{V}_i$
PEEP/CPAP	0 cmH <sub>2</sub> O
P <sub>support</sub>	0 cmH <sub>2</sub> O
Humidifier	Off

### User Set Up:

Power Save	On
Pressure Units	cmH <sub>2</sub> O
Shut Down Alert	On
Auto Panel Lock	Disabled
Buzzer Volume	Loud
Language	English
Parameter Setting	User
Communication protocol	RS-232

42. **Patient Circuit** Reusable 22 mm I.D. adult/pediatric circuit with 3/16 inch (4.8 mm) I.D. proximal pressure sensing line, 1/8 inch (3.2 mm) I.D. exhalation valve control drive line, and exhalation valve. See Appendix A for circuits list. A disposable breathing circuit is available.
43. **Exhalation Valve** NEWPORT's HT50 permanent exhalation valve (p/n HT600039) and disposable exhalation valve (with disposable circuit HT600050) are manufactured and designed specifically for the NEWPORT HT50 Ventilator. NEWPORT does not approve of the use of any other type or brand of exhalation valve.

**HT50-H Humidifier Specifications**

(operates on A.C. power only)

<b>Set Target Temperature Range:</b>	19°C to 39°C
<b>Operating Volume:</b>	300 mL
<b>Usable Volume of Water Bottle:</b>	265 mL
<b>Compliance at Minimum Water Level (Refill Line):</b>	0.5 mL/cmH <sub>2</sub> O/mbar @ 23°C
<b>Compliance at Maximum Water Level (Full Line):</b>	0.33 mL/cmH <sub>2</sub> O/mbar @ 23°C
<b>Intended Use:</b>	Adult and pediatric patients whose supraglottic airway is or is not bypassed.
<b>Warm-Up Time:</b>	30 minutes
<b>Gas Leakage:</b>	2 mL/min at airway pressure of 80 cmH <sub>2</sub> O / 78 mbar
<b>Humidifier Output:</b>	33.8 mg/L at a continuous flow of 10 L/min @ 39°C
<b>Maximum Operating Airway Pressure:</b>	100 cmH <sub>2</sub> O / 100 mbar
<b>Maximum Temperature at the Patient Wye That Triggers an Alarm:</b>	41°C

**(optional) Air / Oxygen Entrainment Mixer Specifications**

<b>Pneumatic Requirements:</b>	
<b>Oxygen</b>	35 to 90 psig (2.4 to 6.2 Bar)
<b>Air</b>	Atmospheric pressure
<b>Control:</b>	F <sub>I</sub> O <sub>2</sub> , adjusted continuously from 0.21 to 1.00, ±8%

**WARNING** Continuous oxygen monitoring is required for patient safety. The HT50 does not have a built-in alarm system to notify user of a failure or disconnect of the oxygen source.

## SPECIFICATIONS

---

### (optional) Oxygen Blending Bag Kit Specifications

#### Pneumatic Requirements:

Oxygen	0-10 L/min (calibrated)
Air	Atmospheric pressure

#### Control:

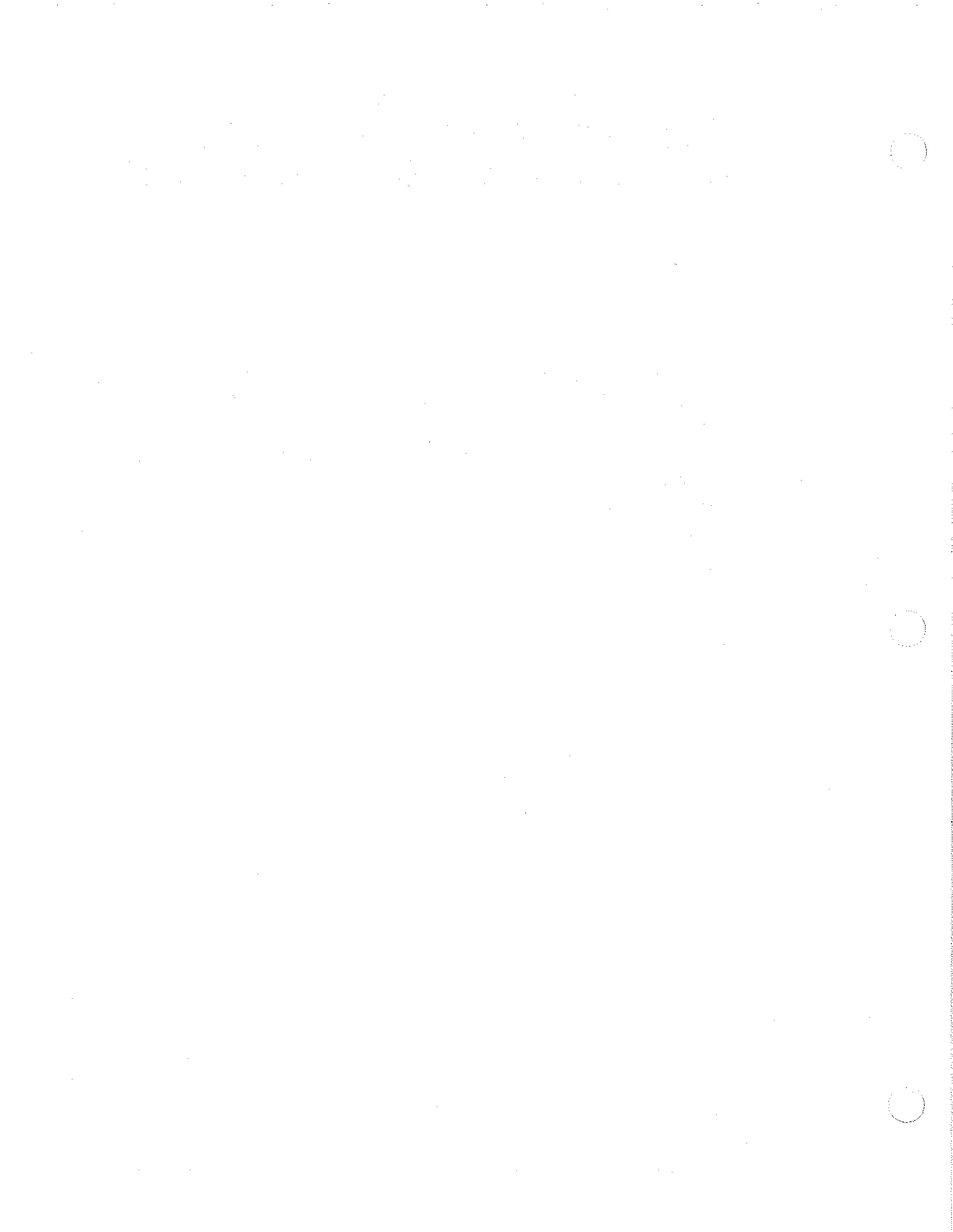
F<sub>I</sub>O<sub>2</sub>, indirectly adjusted from 0.21 up to 1.00  
via oxygen flow (L/min)

**WARNING** Continuous oxygen monitoring is required for patient safety. The HT50 does not have a built-in alarm system to notify user of a failure or disconnect of the oxygen source.

---

# 3. DESCRIPTION OF CONTROLS, INDICATORS, ALARMS & CONNECTORS

Front Panel Overview . . . . .	3-1
Front Panel Controls and Indicators . . . . .	3-6
Front Panel Alarms . . . . .	3-15
Front Panel Message Display Window . . . . .	3-23
Left Side Connectors . . . . .	3-25
Right Side Connectors . . . . .	3-26
Optional Accessories . . . . .	3-27
User Set Up . . . . .	3-28



---

## FRONT PANEL OVERVIEW

The following is an overview of the HT50 front panel button functions. For an indepth description, please review FRONT PANEL CONTROLS AND INDICATORS.

### Turning the HT50 On and Off

#### External (A.C. or D.C.) Power

The On/Standby button toggles between the following conditions:

**Standby** → **Setting** → **On** →→ **Standby**

Press On/Standby button once to go from Standby to Setting. Press again to turn On. Press twice to go from On to Standby.

**Standby:** HT50 dormant with internal battery charging.

**Setting:** Enables setting of control parameters with internal battery charging.

**On:** Enables ventilation with internal battery charging.

#### Internal Battery Power

The On/Standby button toggles between the following conditions:

**Off** → **Setting** → **On** →→ **Off**

Press On/Standby button once to go from Off to Setting. Press again to turn On. Press twice to go from On to Off.

**Off:** HT50 off.

**Setting:** Enables setting of control parameters.

**On:** Enables ventilation.

**NOTE:** There is approximately a two second delay in going from Off to Setting condition.

### Changing the MODE Control

The MODE control buttons ( A/CMV / SIMV / SPONT ) function differently in Setting and On condition.

#### Setting Condition

Press the A/CMV, SIMV or SPONT button. The LED on the selected Mode will light green to confirm the selection.

#### On Condition

Press the A/CMV, SIMV or SPONT button. The LED on the selected Mode will blink green and the Message Display Window will read "PRESS AGAIN." Press the button again within 5 seconds to confirm the mode change, or the previously selected mode will continue.

# DESCRIPTION OF CONTROLS, INDICATORS, ALARMS & CONNECTIONS

---

## Changing between Pressure Control and Volume Control

The Pressure Control and Volume Control buttons function differently when in A/CMV or SIMV in On condition compared to when in SPONT mode in On condition or Settings condition.

**On Condition: A/CMV or SIMV**

**Select—Adjust (▲Up / ▼Down)—Accept**

**Select** the Pressure Control or Volume Control button.

**Adjust** the blinking target value for the selected control with the ▲Up / ▼Down buttons.

**Accept** the new control and target value by pressing the Volume or Pressure control button a second time.

**On Condition: SPONT**

or

**Setting Condition:  
A/CMV, SIMV, or SPONT**

**Select—Adjust (▲Up / ▼Down)—Accept**

**Select** the Pressure Control or Volume Control button. Both the LED indicator and target value will blink.

**Adjust** the blinking target value for the selected control with the ▲Up / ▼Down buttons.

**Accept** the new control and target value by either pressing the selected button again; or by pressing another button to select a new parameter for adjustment, or by waiting 5 seconds without making a change.

**Note:** The transition to a new pressure or volume target may require several breaths.

## Changing a Parameter (or Multiple Parameters)

**Select—Adjust (▲Up / ▼Down)—Accept**

**Select** the parameter by pressing the labeled button (i.e. *f*, *P* trig, etc). The parameter's numeric display will blink.

**Adjust** the numeric value with the ▲Up / ▼Down buttons.

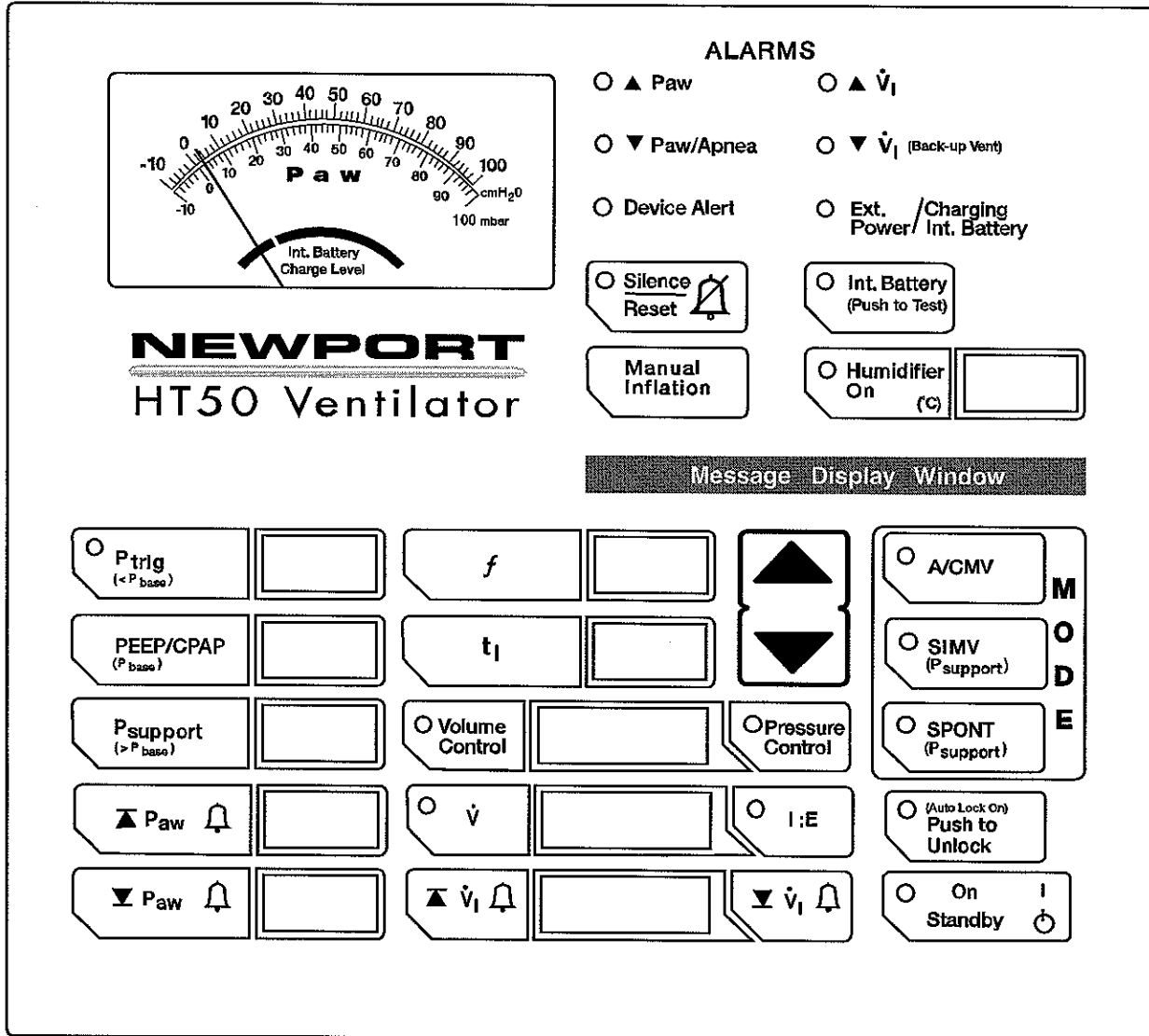
**Accept** the value by either pressing the selected button again; or by pressing another button to select a new parameter for adjustment, or by waiting 5 seconds without making a change.

**Enabling/Disabling Auto Panel Lock**

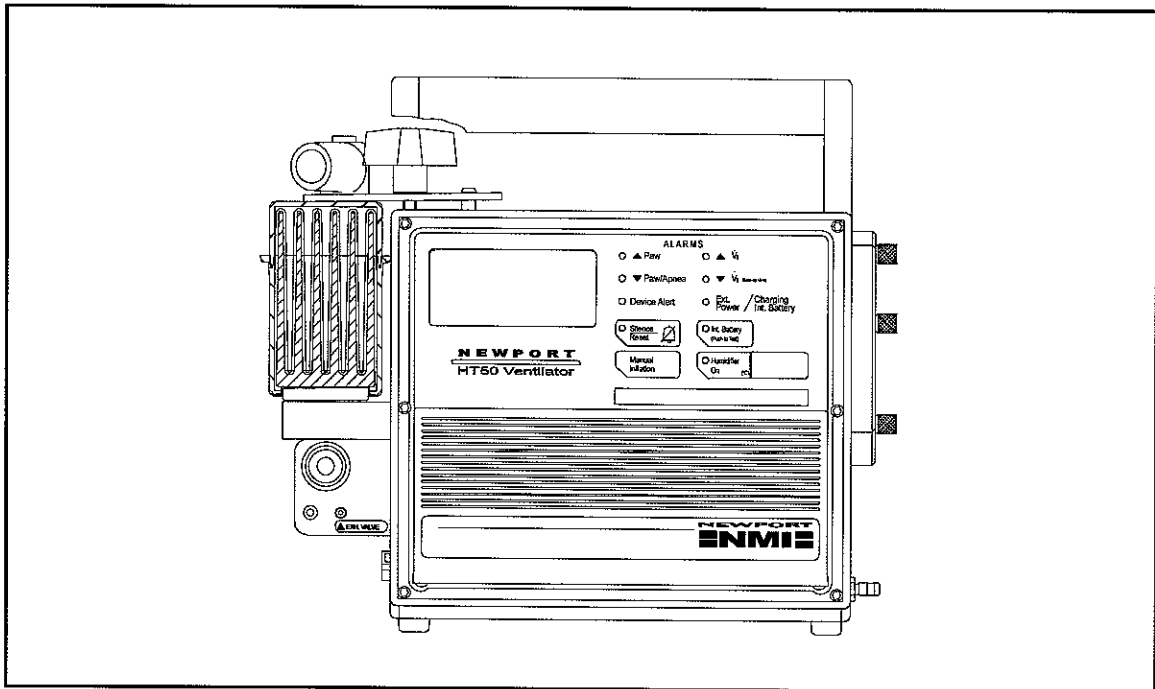
Auto Panel Lock can be enabled or disabled via User Set Up (see pg 3-27). When the Auto Panel Lock is enabled the LED lights green, all touch buttons (except Silence/Reset and Internal Battery Test) are locked, preventing accidental parameter changes.

**NOTE:** Auto Panel Lock is factory preset to "Disabled" (off).

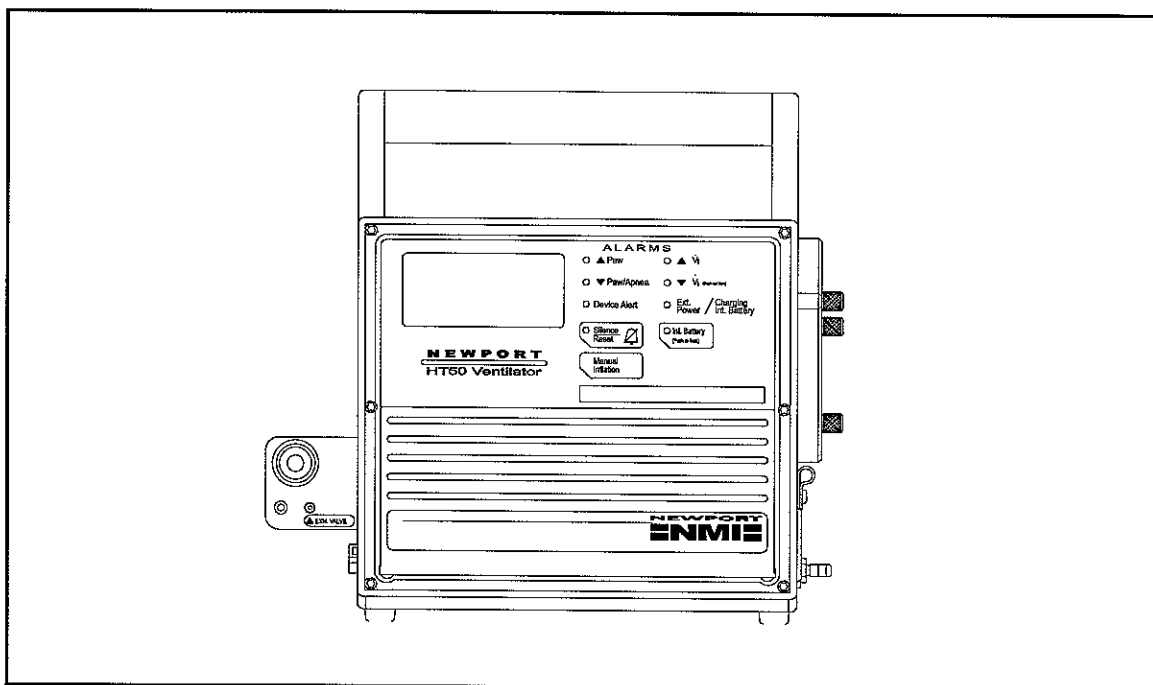
# DESCRIPTION OF CONTROLS, INDICATORS, ALARMS & CONNECTIONS



**Figure 3-1**  
**HT50 Ventilator Front Panel**  
**(model HT50-H)**



**Figure 3-2**  
Newport HT50-H (with humidifier)



**Figure 3-3**  
Newport HT50-H1/T (without humidifier)

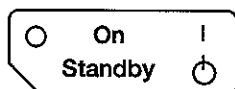
# DESCRIPTION OF CONTROLS, INDICATORS, ALARMS & CONNECTIONS

## FRONT PANEL CONTROLS & INDICATORS

Front panel controls that have corresponding LED indicators are included with the description of the control.

The HT50 front panel is shown in Figure 3-1 on pg 3-4.

### On / Standby



When powered on external power, this button toggles between the following conditions:

**Standby** (the system is being charged) → **Setting** (allows setting of control parameters) → **On** (enables ventilation) →→ **Standby**

When powered on internal battery, this button toggles between the following conditions:

**Off** → **Setting** → **On** →→ **Off**

**Standby:** The HT50 is in Standby condition when it is connected to external power and ventilation is not enabled. The Ext. Power/Charging Int. Battery LED is lit green, indicating that the internal battery is being charged. The On/Standby indicator is not lit.

There is no Standby condition when the HT50 is powered by the internal battery.

**Setting:** Pressing the On/Standby button once changes the ventilator from Standby to Setting condition (external power) or Off to Setting condition (internal battery).

**NOTE:** When operating on internal battery, there will be approximately a two second delay when going from Off to Setting condition.

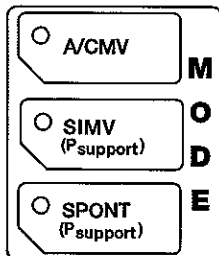
During Setting condition, all adjustable LEDs are lit. This allows the operator to preset and adjust controls prior to ventilation. The On/Standby indicator is not lit. The Message Display Window shows "Press ON to Vent," suggesting that the On/Standby button needs to be pressed if you want the HT50 to start ventilation.

**On:** Pressing the On/Standby button once more changes the ventilator from Setting to On. In the On condition, the HT50 is ventilating and the On/Standby indicator is lit green.

**Off:** When the HT50 is powered by the internal battery, pressing the On/Standby button twice while in On condition turns the ventilator from On to Off.

When the HT50 is powered by external power, pressing the On/Standby button twice while in On condition turns the ventilator from On to Standby.

## MODE Control



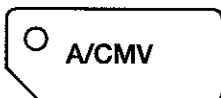
The MODE control buttons enable the user to switch between the following operational modes:

- A/CMV
- SIMV
- SPONT

In A/CMV and SIMV, mandatory breaths can be pressure controlled or volume controlled. A green LED indicates which operational mode is active.

If the HT50 is in Setting condition, changes are made by pressing the requested MODE button once. If in ON condition, changes are made by pressing the requested MODE button twice. After the first press, the Message Display Window reads "PRESS AGAIN" and the requested MODE's indicator starts to blink. If the requested MODE button is not pressed within 5 seconds, the change is cancelled.

### A/CMV (Assist / Control Mandatory Ventilation)

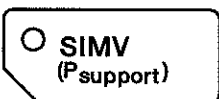


In A/CMV, the user may choose to pressure or volume control mandatory breaths. In either case, all breaths delivered to the patient, whether time (ventilator initiated) or patient-triggered, are the same.

The  $f$  (frequency) setting determines the number of time-triggered mandatory breaths delivered each minute. The P<sub>trig</sub> setting determines the airway pressure threshold that patient effort must reach to trigger additional mandatory breaths. If patient effort doesn't cause airway pressure to drop enough to meet the P<sub>trig</sub> threshold, or if the patient doesn't breathe, the HT50 will deliver the set  $f$  (frequency) of mandatory breaths.

**NOTE:** If the P<sub>trig</sub> setting is not adjusted to a level that allows the patient's inspiratory effort to be detected, A/CMV mode performs as CMV (control) mode.

### SIMV (Synchronized Intermittent Mandatory Ventilation)



In SIMV, the user may choose to pressure or volume control mandatory breaths. In either case, all mandatory breaths delivered to the patient, whether time (ventilator initiated) or patient-triggered, are the same. In addition, the user may choose to pressure support the spontaneous breaths in between mandatory breaths.

Unlike A/CMV, the  $f$  (frequency) setting in this mode determines the total rather than the minimum number of time (ventilator) or patient triggered mandatory breaths delivered each minute.

## DESCRIPTION OF CONTROLS, INDICATORS, ALARMS & CONNECTIONS

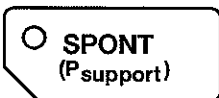
---

The  $f$  (frequency) setting also establishes a timing window which determines whether a patient trigger results in a mandatory breath or a spontaneous breath.

The  $P_{trig}$  setting determines the airway pressure threshold that patient effort must reach to trigger mandatory breaths and also to trigger spontaneous breaths in between mandatory breaths.

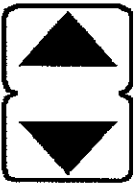
If patient effort doesn't cause airway pressure to drop enough to meet the  $P_{trig}$  threshold or if the patient doesn't breathe, the HT50 will deliver the set  $f$  (frequency) of mandatory breaths each minute.

### SPONT (Spontaneous Ventilation)



In this mode, all breaths are patient initiated spontaneous efforts.  $P_{support}$  (Pressure Support Ventilation) may be used to support spontaneous efforts. When PEEP/CPAP is set above 0, the ventilator mode is CPAP (without  $P_{support}$ ) or Bilevel Positive Airway Pressure (with  $P_{support}$ ).

### ▲ Up and ▼ Down Control



The ▲Up/▼Down control buttons have multiple uses on the HT50.

**1. Parameter Adjustment:** Use the ▲Up/▼Down buttons to adjust ventilation control parameter values (including Pressure Control and Volume Control values), alarms, and humidifier setting (if available). Select the desired parameter by pressing its touch button once. The corresponding value (numerical display) will blink. Press the ▲Up control to increase or the ▼Down to decrease the affected parameter value. The value continuously changes when the ▲Up/▼Down controls are pressed and held. The value adjustment is accepted if (1) the user presses the selected parameter button again, or (2) the user selects a different parameter, or (3) five seconds elapses. Pressing a parameter button without pressing either the ▲Up or ▼Down control button within 5 seconds causes the parameter to retain its current value.

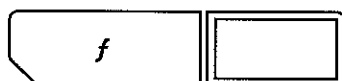
**NOTE:** If in the On condition and switching between Volume Control and Pressure Control, the value adjustment for the new breath type selected (Volume or Pressure) will be accepted only if the user presses the new breath type control button again.

**2. Monitored Information:** The ▲Up/▼Down controls are used to access and display monitoring messages in the Message Display Window. Monitored information includes volume, frequency and pressure values. See pg 3-23 for more information on the Message Display Window.

When the HT50 is ventilating, and there are no alarm messages displayed on the Message Display Window, press the ▲Up control button to access the monitoring messages. Pressing the ▲Up button again allows you to scroll through the messages.

**3. Changing Default Settings:** The ▲Up/▼Down controls are also used in User Set Up to change a set up value or to adjust calibrations. See User Set Up on pg 3-27 for more details.

**$f$**   
(frequency)



**Range:** 1 to 99 b/min

The  $f$  (frequency) setting determines the minimum number of time triggered mandatory breaths in the A/CMV mode and the total number of mandatory breaths in the SIMV mode. The frequency or rate value is displayed in the window adjacent to the selector button.

The user is alerted to frequency settings which result in an inverse I:E Ratio by an audible beep and an "Inverse I:E" message in the Message Display Window. Attempts to continue increasing the value after this alert are permitted up to an I:E Ratio of 3:1.

**NOTE:** In SPONT mode, the  $f$  setting is not utilized but the value can be preset.

**$t_I$**   
(inspiratory time)



**Range:** 0.1 to 3.0 sec

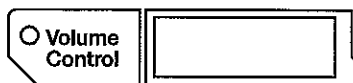
The  $t_I$  setting determines the inspiratory time for mandatory breaths (volume or pressure control). The selected time value is displayed in the window adjacent to the selector button. The user is alerted to  $t_I$  settings which result in an inverse I:E Ratio by an audible beep and an "Inverse I:E" message in the Message Display Window. Attempts to continue increasing the value after this alert are permitted up to an I:E Ratio of 3:1. If the inspiratory time setting causes the flow rate to reach the maximum or minimum level of the flow specification, adjustment of  $t_I$  ceases, a beep sounds, and a setting limitation message appears in the Message Display Window.

**NOTE:** In SPONT mode, the  $t_I$  setting is not utilized but the value can be preset.

**NOTE:** See pg. 3-24 for a list of setting limitation messages.

## DESCRIPTION OF CONTROLS, INDICATORS, ALARMS & CONNECTIONS

### Volume Control (tidal volume)



**Range:** 100 to 2,200 mL, ATPX

Pressing this control button, followed by pressing the ▲Up/▼Down controls, allows the adjustment of the tidal volume setting. When the green Volume Control LED illuminates, the adjacent window displays the set tidal volume. See Theory of Operation, pg 4-4 for more details.

If the Volume Control setting causes the flow rate to reach the maximum or minimum level of the flow specification, adjustment of Volume Control ceases, a beep sounds, and a setting limitation message appears in the Message Display Window.

**NOTE:** See pg. 3-24 for a list of setting limitation messages.

**NOTE:** In SPONT mode, the Volume Control is not utilized but the value can be preset.

#### Switching from Pressure Control to Volume Control:

Press the Volume Control button. The set tidal volume is displayed in the adjacent window and a "PRESS AGAIN" message appears in the Message Display Window.

Adjust the tidal volume level by pressing the ▲Up/▼Down controls while the LED and numerical display are blinking. Press the Volume Control button again within 5 seconds following adjustment.

### Pressure Control (target pressure)



**Range:** 5 to 60 cmH<sub>2</sub>O/mbar

Pressing this control button, followed by pressing the ▲Up/▼Down controls, allows the adjustment of the target airway pressure setting. Target pressure is referenced to ambient (atmospheric pressure). When the green Pressure Control LED illuminates, the adjacent window displays the set airway pressure. See Theory of Operation pg 4-4 for more details.

**NOTE:** When disconnecting the patient circuit during PCV/PSV ventilation, i.e. for suctioning, the flow may increase in order to compensate for the low pressure. After reconnecting the patient circuit, press the PCV/PSV button twice to quickly re-adjust flow to a lower level.

**NOTE:** In SPONT mode, the Pressure Control is not utilized but the value can be preset.

**Switching from Volume Control to Pressure Control:**

Press the Pressure Control button. The set target airway pressure value is displayed in the adjacent window and a "PRESS AGAIN" message appears in the Message Display Window.

Adjust the set target airway pressure by pressing the ▲Up/▼Down controls while the LED and numerical display are blinking. Press the Pressure Control button again within 5 seconds following adjustment.

**NOTE:** The minimum target airway pressure is 5 cmH<sub>2</sub>O/mbar above set baseline pressure.

**P<sub>trig</sub> Control  
(sensitivity)**

**Range:** 0 to -9.9 cmH<sub>2</sub>O/mbar

The P<sub>trig</sub> setting determines trigger sensitivity in terms of how far airway pressure must drop below the set baseline pressure for a patient's spontaneous efforts to be detected. The P<sub>trig</sub> LED indicator illuminates each time the airway pressure reaches the set P<sub>trig</sub> level, and turns off once the airway pressure has returned to baseline pressure. The blinking P<sub>trig</sub> LED is referred to as the Patient Effort Indicator. The P<sub>trig</sub> value is displayed in the adjacent window.

**PEEP / CPAP**

**Range:** 0 to 30 cmH<sub>2</sub>O/mbar

The PEEP/CPAP setting establishes airway pressure in the patient circuit during the exhalation phase. It is also referred to as base or baseline pressure. The set PEEP/CPAP value is displayed in the adjacent window.

**NOTE:** In Pressure Control ventilation, PEEP/CPAP cannot be set higher than 5 cmH<sub>2</sub>O/mbar below the set Pressure Control setting.

**NOTE:** The value of PEEP/CPAP plus P<sub>support</sub> cannot exceed 60 cmH<sub>2</sub>O/mbar.

**P<sub>support</sub>  
(pressure support)**

**Range:** 0 to 60 cmH<sub>2</sub>O/mbar

The P<sub>support</sub> (pressure support) setting determines the target rise in pressure during inspiration for patient triggered spontaneous breaths in SIMV and SPONT modes. The target pressure is the set P<sub>support</sub> plus the PEEP level.

## DESCRIPTION OF CONTROLS, INDICATORS, ALARMS & CONNECTIONS

Any time the active P support control is pressed, P support flow delivery slows to a lower level then it gradually increases to the appropriate level as pressure rise is re-assessed.

**NOTE:** The value of PEEP/CPAP plus P support cannot exceed 60 cmH<sub>2</sub>O/mbar.

### Manual Inflation



**Range:** 0 to 3.0 sec

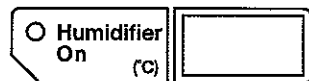
Pressing this button delivers an operator initiated Manual Inflation. Pressing the Manual Inflation button will not initiate an inflation if the patient is currently in the inspiratory phase of a breath or if airway pressure is > 5 cmH<sub>2</sub>O/mbar above the set PEEP/CPAP level. Manual Inflation delivers the set flow rate (in Volume Control) or the set target pressure (in Pressure Control), but inspiratory time is controlled by the user.

During Manual Inflation, the breath is terminated if (1) the Manual Inflation button is released, or (2) the ▲Paw (High Pressure) alarm is violated or (3) three seconds have elapsed.

**NOTE:** Manual Inflation is only available in A/CMV and SIMV modes.

**NOTE:** Manual Inflation may be prematurely cycled off in the first several breaths in Pressure Control when the initial flow has not yet been optimized.

### Humidifier On Button (HT50-H only)



**Range:** 19°C to 39°C

This touch button activates the built-in humidifier. Pressing this button displays the set target temperature in the adjacent window. While the display is blinking, use the ▲Up/▼Down controls to adjust the target temperature. When temperature adjustment is complete and (1) five seconds have elapsed without touching the control, (2) the Humidifier On button is pressed again, or (3) another parameter is selected for adjustment, the display stops blinking and the measured temperature is displayed. While the humidifier is On, the target temperature can be readjusted at any time by pressing the Humidifier On button and using the ▲Up/▼Down controls.

**NOTE:** Preheating the humidifier for 30 minutes prior to beginning ventilation will improve the heating performance of the humidifier.

During ventilation (On condition) the displayed temperature is the measured temperature at the patient connector. In the Setting condition, the displayed temperature is the measured temperature at the humidifier bottle outlet.

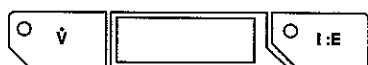
To turn the humidifier Off, press and hold the Humidifier On button for three seconds.

**NOTE:** The measured proximal temperature may be different from the set target temperature due to the environmental temperature, minute volume, patient temperature, etc.

**NOTE:** The humidifier is operational only when the HT50 is powered by external A.C. power.

**NOTE:** If the humidifier and/or the temperature probe is removed or malfunctions or if the humidifier bottle is removed prior to turning the humidifier off, the Humidifier On LED changes from green to blinking yellow, an audible alarm sounds and the heater shuts down automatically. To restart the humidifier, correct the alarm condition and press the Humidifier On button.

**$\dot{V}$**   
**(mandatory flow)**



**Range:** 6 to 100 L/min

$\dot{V}$  shares a numeric display window with I:E Ratio.  
 $\dot{V}$  LED is illuminated green when flow is displayed.

Displays the calculated flow delivered from the ventilator during volume controlled mandatory breaths.  $\dot{V}$  display is not available during Pressure Controlled breaths or SPONT mode.

**NOTE:** Flow can be adjusted indirectly by changing the tidal volume (Volume Control) or  $t_I$  settings.

**I:E Ratio**  
**(inspiratory time to expiratory time)**

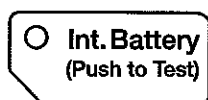


**Range:** 1:99 to 3:1

I:E Ratio shares a numeric display window with  $\dot{V}$ .  
I:E LED is illuminated green when I:E Ratio is displayed.

I:E Ratio is determined by the  $f$  and  $t_I$  settings. If expiratory time is longer than inspiratory time, the display format is 1:X.X. If expiratory time is shorter than  $t_I$ , the display format is X.X:1. When the I:E Ratio is inverse, the I:E Ratio indicator illuminates once every breath. I:E Ratio does not function during SPONT mode.

**Internal Battery Test Button**



When the HT50 is powered by the internal battery, this LED illuminates. A yellow LED indicates the battery is charged and a blinking yellow LED indicates low power. When the battery is completely discharged, the LED blinks red.

Pressing this button allows the battery charge level to be read in the Paw meter window. When the HT50 is on external power, pressing the Int. Battery button also tests the Battery Charging

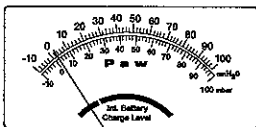
## DESCRIPTION OF CONTROLS, INDICATORS, ALARMS & CONNECTIONS

Circuit. If the charging circuit is damaged, a "Charge Fault" message is displayed in the Message Display Window. If this occurs, contact NEWPORT Technical Service Department.

The HT50 internal battery should be tested periodically to verify that the charge level is in the blue area. The battery must be used or discharged and recharged at least once every six months.

**NOTE:** Do not try to test the battery charging circuit when the HT50 consumes extreme power. When the humidifier is operating and/or high ventilator settings are used, the battery charging circuit may not be active.

### Internal Battery Charge Level Meter



The Int. Battery Charge Level meter is located beneath the Paw meter. The red area indicates low battery charge. The blue area indicates medium to full battery charge.

**NOTE:** The battery charge level is best maintained by keeping the HT50 continuously plugged into an external power source.

### Push to Unlock Button and Auto Lock Indicator



Auto Panel Lock can be enabled or disabled via User Set Up (see pg 3-30). When Auto Lock is set to "Enabled" in User Set Up and the ventilator is in On condition and 20 seconds have elapsed without pressing any buttons, the Auto Lock function is automatically activated and the (Auto Lock On) LED illuminates green. When Auto Lock is active, all touch buttons (except Silence/Reset and Int. Battery Test) are locked, preventing accidental changes.

Press and hold the Push to Unlock button for at least one second to unlock the panel and enable the activation of all touch buttons for adjustment. An audible beep sounds and the LED is extinguished. When 20 seconds have elapsed without pressing any buttons, the Auto Lock is automatically activated again.

**NOTE:** Auto Panel Lock is factory preset to "Disabled" (off).

### Silence / Reset

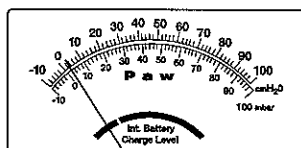


The Silence/Reset button has two functions:

1. Silencing alarms: Press the Silence/Reset button to silence all alarms for 60 seconds. When the Silence/Reset indicator is illuminated, all alarms are silenced. Press the Silence/Reset button again to cancel the silence period.
2. Clearing alarm messages: Press the Silence/Reset button to clear all alarm messages in the Message Display Window and to release latched LED indicators when the cause for the alarm is no longer present.

**NOTE:** The Device Alert Alarm and the Battery Empty Alarm can not be silenced. These alarms indicate that an alternate source of ventilation must be utilized. See pgs 3-20 and 3-21 for more details.

**Paw Meter  
(airway pressure meter)**



**Range:** -10 to 100 cmH<sub>2</sub>O / 100 mbar

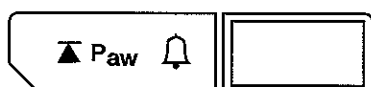
The Paw meter displays airway pressure. It also indicates the internal battery charge level when the Int. Battery button is pressed.

**FRONT PANEL ALARMS**

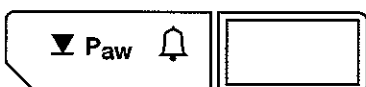
The front panel alarm LED indicators blink when an alarm setting is violated. Once the violation is no longer in effect, the indicators latch (remain steadily lit) until they are reset by pressing the Silence/Reset button.

**High  $\bar{\Delta}$  Paw and Low  $\nabla$  Paw Alarm Control and Display  
(airway pressure)**

<b>Range:</b>	Paw	-10 to 100 cmH <sub>2</sub> O / 100 mbar
	High $\bar{\Delta}$ Paw Alarm	4 to 99 cmH <sub>2</sub> O / 99 mbar
	Low $\nabla$ Paw Alarm	3 to 98 cmH <sub>2</sub> O / 99 mbar



The  $\bar{\Delta}$  Paw button allows the selection of the high (peak) airway pressure alarm setting.



The  $\nabla$  Paw button allows the selection of the low peak airway pressure alarm setting.

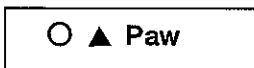
To adjust either alarm, press the desired button once. The value in the adjacent display window will blink. Use the  $\bar{\Delta}$ Up/ $\nabla$ Down controls to adjust the displayed alarm setting value. The new setting can be retained by (1) pressing the selected button again to accept the alarm setting, (2) selecting another parameter for adjustment, or (3) allowing five seconds to elapse without adjustment.

**NOTE:** In SPONT mode the  $\nabla$  Paw alarm is inactive but the value can be preset.

**NOTE:** The  $\nabla$  Paw alarm setting cannot be a value below PEEP/CPAP + 3. The  $\bar{\Delta}$  Paw alarm setting must be a value at least 1 above the  $\nabla$  Paw alarm setting.

## DESCRIPTION OF CONTROLS, INDICATORS, ALARMS & CONNECTIONS

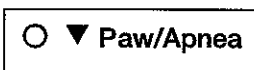
### ▲ Paw (High Pressure) Alarm (user adjustable)



**Audible Alarm:** Intermittent beep  
**Visual Alarm:** ▲Paw indicator blinks red  
**Message Window:** HIGH PRESSURE

The High ▲Paw Alarm is triggered when airway pressure (Paw) reaches the ▲ Paw alarm setting. Any breath in progress immediately cycles to exhalation. The alarm violation is cancelled when Paw falls below the Paw alarm setting and at least one second has elapsed since the alarm was triggered.

### ▼ Paw (Low Pressure) Alarm (user adjustable)



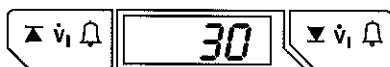
**Audible Alarm:** Intermittent beep  
**Visual Alarm:** ▼Paw indicator blinks red  
**Message Window:** LOW PRESSURE

The Low ▼Paw Alarm is triggered when airway pressure remains below the ▼Paw alarm setting for two consecutive mandatory breaths. The alarm violation is cancelled when one mandatory breath is delivered without a ▼Paw alarm violation.

**NOTE:** The Low ▼Paw Alarm does not function in SPONT mode. The ▼Paw alarm does not apply to spontaneous breaths in SIMV mode.

### High ▲ $\dot{V}_I$ and Low ▼ $\dot{V}_I$ Alarm Control and Display (inspiratory minute volume)

<b>Range:</b>	$\dot{V}_I$	0 to 99.0 L/min
	High ▲ $\dot{V}_I$ Alarm	2 to 50.0 L/min
	Low ▼ $\dot{V}_I$ Alarm	0.3 to 49.0 L/min

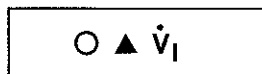


This window displays the inspiratory minute volume (in liters) and is automatically updated every 10 seconds. The  $\dot{V}_I$  window always displays the delivered minute volume, except when the user is in the process of setting either the High or Low  $\dot{V}_I$  alarm.

To adjust the High or Low  $\dot{V}_I$  alarm, press the ▲ or ▼  $\dot{V}_I$  button. The value in the adjacent display window will blink. Use the ▲Up/▼Down controls to adjust the displayed alarm setting value. The new setting can be retained by (1) pressing the selected button again to accept the alarm setting, (2) selecting another parameter for adjustment, or (3) allowing five seconds to elapse without adjustment.

**NOTE:** The high inspiratory minute volume alarm setting cannot be a value below the low alarm setting. The low alarm setting cannot be a value higher than the high alarm setting.

### ▲ $\dot{V}_I$ (High Insp. Minute Volume) Alarm (user adjustable)

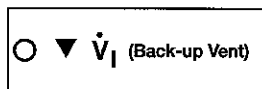


**Audible Alarm:** Intermittent beep  
**Visual Alarm:** ▲ $\dot{V}_I$  indicator blinks red  
**Message Window:** HIGH  $\dot{V}_I$

The High Insp. Minute Volume Alarm is triggered when the delivered inspiratory minute volume exceeds the High ▲ $\dot{V}_I$  alarm setting. The alarm is cancelled after delivered inspiratory minute volume falls below the ▲ $\dot{V}_I$  alarm setting.

**WARNING** The Insp. Minute Volume Alarms are based on the delivered volume from the ventilator. The actual minute volume in the patient lungs may be significantly different in cases such as circuit leak, disconnection, and pneumothorax. To verify the minute volume in the patient lungs, use a separate exhaled volume monitor.

### ▼ $\dot{V}_I$ (Low Insp. Minute Volume) Alarm Back-up Ventilation (user adjustable)



**Audible Alarm:** Intermittent beep  
**Visual Alarm:** ▼ $\dot{V}_I$  indicator blinks red  
**Message Window:** LOW  $\dot{V}_I$   
 LOW  $\dot{V}_I$  (BUV) (when back-up ventilation is active)

The Low Insp. Minute Volume Alarm is triggered when delivered inspiratory minute volume falls below the Low ▼ $\dot{V}_I$  alarm setting.

**WARNING** The Insp. Minute Volume Alarms are based on the delivered volume from the ventilator. The actual minute volume in the patient lungs may be significantly different in cases such as circuit leak, disconnection, and pneumothorax. To verify the minute volume in the patient lungs, use a separate exhaled volume monitor.

#### Back-up Ventilation

Back-up Ventilation is an alarmed function that activates when the delivered inspiratory minute volume ( $\dot{V}_I$ ) falls below the Low ▼ $\dot{V}_I$  setting. During Back-up Ventilation, the Low ▼ $\dot{V}_I$  (Back-up Vent) alarm indicator blinks, an audible alarm sounds, and "LOW  $\dot{V}_I$  (BUV)" is displayed in the Message Display Window. The default ventilation settings employed by Back-up Ventilation are displayed on the front panel.

Back-up Ventilation is functional in all modes. See page 4-5 for a complete description of Back-up Ventilation.

## DESCRIPTION OF CONTROLS, INDICATORS, ALARMS & CONNECTIONS

---

### High Baseline Pressure Alarm (automatic)



**Audible Alarm:** Intermittent beep  
**Visual Alarm:** ▲Paw indicator blinks red  
**Message Window:** HIGH Pbase

The High Baseline Pressure (High Pbase) alarm is triggered when airway pressure is above the Low ▼ Paw alarm setting at the beginning of a time triggered mandatory breath. The alarm resets when Paw drops to within 5 cmH<sub>2</sub>O/mbar of the set PEEP/CPAP level.

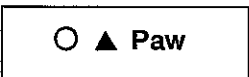
### Occlusion Alarm, Circuit (automatic)



**Audible Alarm:** Intermittent beep  
**Visual Alarm:** ▲Paw indicator blinks red at the high priority rate  
**Message Window:** OCCLUSION

An Occlusion alarm is triggered when airway pressure is above the set PEEP + 15 cmH<sub>2</sub>O/mbar at 3 seconds after the beginning of expiration, or at the end of expiration, whichever comes first. When a breathing circuit occlusion occurs, the ventilator will be unable to release the pressure, therefore additional breaths will not be delivered until the condition is corrected. The alarm resets when airway pressure falls to within 5 cmH<sub>2</sub>O/mbar of baseline, at which point breath delivery is resumed.

### Occlusion Alarm, Device (automatic)



**Audible Alarm:** Intermittent beep  
**Visual Alarm:** ▲Paw indicator blinks red at the high priority rate and Device Alert indicator blinks  
**Message Window:** OCCLUSION

An Occlusion alarm is triggered when airway pressure is above the set PEEP + 15 cmH<sub>2</sub>O/mbar at 3 seconds after the beginning of expiration, or at the end of expiration, whichever comes first. When the Occlusion alarm is caused by a malfunction inside the ventilator, the HT50 will attempt to relieve circuit pressure through its redundant safety system. If successful, ventilation will continue, but in an alarmed state. It is possible that the condition causing the alarm will self-correct, in which case the alarm is reset. Otherwise, the ventilator will continue to alarm until the necessary service is performed. If the HT50 is unsuccessful in relieving circuit pressure, a Device Alert alarm (OCCL SHUTDOWN) will occur. See pg. 3-22 for more details.

**NOTE:** A Device Alert alarm cannot be silenced by pressing the Silence/Reset button.

**WARNING** Any time a Device Alert violation occurs along with the message "OCCLUSION," an alternate method of ventilation should be provided for the patient as soon as possible so that the cause of the violation can be adequately and safely investigated.

### Low Baseline Pressure Alarm (automatic)

▼ Paw/Apnea

**Audible Alarm:** Intermittent beep  
**Visual Alarm:** ▼Paw/Apnea indicator blinks red  
**Message Window:** LOW Pbase

The Low Baseline Pressure (Low Pbase) Alarm is triggered by an unstable baseline (leak in the breathing circuit) or by a baseline decrease since the last PEEP/CPAP control change. A Low Pbase violation occurs in all modes when airway pressure remains  $\geq 2$  cmH<sub>2</sub>O/mbar below baseline for 3 seconds. The same LED that blinks during Low ▼Paw violations blinks when this alarm is triggered. The alarm resets when airway pressure is  $< 2$  cmH<sub>2</sub>O/mbar below baseline.

### Check Prox Line Alarm (automatic)

▼ Paw/Apnea

**Audible Alarm:** Intermittent beep  
**Visual Alarm:** ▼Paw/Apnea indicator blinks red  
**Message Window:** CHECK PROX LINE

The Check Prox Line Alarm is triggered when, during inspiration, the pressure measurement of the proximal pressure sensing line is significantly different from the internal back up pressure sensing line located inside the ventilator. This may be caused by a disconnected, kinked, water-filled proximal sensing line, or a blocked proximal line filter. Ventilation is continued during the alarm condition, using the pressure measurement of the internal sensing line.

### Apnea Alarm (automatic)

▼ Paw/Apnea

**Audible Alarm:** Intermittent beep  
**Visual Alarm:** ▼Paw/Apnea indicator blinks red  
**Message Window:** APNEA

The Apnea Alarm is triggered when no mandatory breaths or detected spontaneous efforts occur for 30 seconds. The alarm is reset by a time or patient trigger.

## DESCRIPTION OF CONTROLS, INDICATORS, ALARMS & CONNECTIONS

---

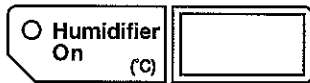
### PCV Not Reached Alarm (automatic)



**Audible Alarm:** Intermittent beep  
**Visual Alarm:** ▼Paw/Apnea indicator blinks red  
**Message Window:** PCV NOT REACHED

The PCV Not Reached Alarm is triggered in pressure control ventilation when the maximum inspiratory pressure (Paw P) is less than 50% of the target pressure for 2 consecutive mandatory breaths. The alarm is reset when maximum inspiratory pressure (Paw P) is  $\geq 50\%$  of the target pressure.

### Humidifier Alarm (automatic) HT50-H only



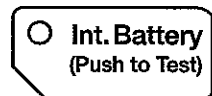
**Audible Alarm:** Intermittent 3-pulse caution beep  
**Visual Alarm:** Humidifier indicator blinks yellow

The Humidifier Alarm is triggered when a malfunction occurs in the HT50 built-in humidifier. When an alarm condition is detected the humidifier heater shuts down.

There are five humidifier alarms:

<u>Message Display Window</u>	<u>Cause of Alarm</u>
Check Humidifier	Bottle removed or not clamped properly when trying to activate the humidifier. Temp Probe not connected or missing when trying to activate the humidifier.
Humidifier Fail	Bottle removed while humidifier is On. Failure of the primary humidifier control.
Check Temp Probe	Temp Probe damaged or missing while humidifier is On.
High Prox Temp	Proximal temperature exceeds set target temperature by 2°C.
High Temp Core	Excessive temperature in the humidifier heating element.

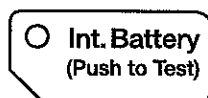
**NOTE:** The Humidifier Alarm is automatically set when using the HT50 humidifier. Humidifier Alarms (and the built-in humidifier) do not function when the HT50 is powered on internal battery.

**Battery Low Alarm  
(automatic)**

**Audible Alarm:** Intermittent 3-pulse caution beeps  
**Visual Alarm:** Int. Battery indicator blinks yellow  
**Message Window:** Battery Low

Indicates that less than approximately two hours of operating power remain in the internal battery. Pressing the Silence/Reset button will cancel the audible alarm but the visual alarm will continue to blink as long as the alarm condition continues. The alarm is reset when A.C. or external D.C. power is connected to the HT50.

**NOTE:** The actual time remaining depends on the ventilator settings used.

**Battery Empty Alarm  
(automatic)**

**Audible Alarm:** Intermittent beep  
**Visual Alarm:** Int. Battery indicator blinks red  
**Message Window:** BATTERY EMPTY

Indicates that less than approximately 30 minutes of operating power remain in the internal battery. An alternate power source must be located. This alarm cannot be silenced or reset as long as the alarm condition continues. The alarm is reset when A.C. or external D.C. power is connected to the HT50.

**NOTE:** The actual time remaining depends on the ventilator settings used.

**NOTE:** Frequent deep discharge of the internal battery will decrease the amount of time the HT50 will operate on battery power from a full charge state.

**WARNING** Immediately secure an external power source when the Battery Empty alarm is violated. Charge the battery for a minimum of 5 hours (~80% recharged) before powering the ventilator again from the internal battery. If the battery is completely depleted, it takes approximately 7 to 8 hours to fully recharge.

**NOTE:** When the HT50 is used for transport applications (p/n HT50-T), ensure that the internal battery is fully charged prior to use.

## DESCRIPTION OF CONTROLS, INDICATORS, ALARMS & CONNECTIONS

---

### Power Switchover Alarm (automatic)

Ext. Power / Charging  
                  Int. Battery

Int. Battery  
(Push to Test)

**Audible Alarm:** Intermittent 3-pulse caution beeps  
**Visual Alarm:** Ext. Power indicator illuminates red  
                          Int. Battery indicator blinks yellow  
**Message Window:** No ext power

The Power Switchover Alarm is triggered by switching from external power to the internal battery due to disconnection from the power cord or a power interruption. Pressing the Silence/Reset button will (1) cancel the audible alarm, (2) cancel the "No ext power" message, (3) cancel the Ext. Power LED and (4) cause the Int. Battery LED to change to non-blinking yellow indicator.

If external power is reconnected within 60 seconds of power loss, the HT50 will immediately switch back to external power. If it takes longer than 60 seconds for external power to be reconnected, the HT50 will switch back to external power within 60 seconds following the reconnection. If "No ext power" message is still displayed following the reconnection to external power, press Silence/Reset button to cancel the message.

### Device Alert Alarm (automatic)

Device Alert

**Audible Alarm:** Intermittent beep  
**Visual Alarm:** Device Alert indicator blinks red  
**Message Window:** MOTOR FAULT or OCCLUSION or OCCL  
                          SHUTDOWN or 10V SHUTDOWN or  
                          SYSTEM ERROR

The Device Alert Alarm is triggered when the microprocessor detects a functional problem with the ventilator. With the exception of "OCCLUSION," all other Device Alert messages will result in the HT50 discontinuing ventilation. When this occurs, the ventilator cannot be used for patient care. DO NOT use the ventilator until the cause of the alert has been determined and corrected.

**NOTE:** See Pg. 3-18, Occlusion Alarm, Device, for detailed description.

The remaining four possible messages that will be displayed when a Device Alert Alarm occurs; (1) MOTOR FAULT (2) OCCL SHUTDOWN, (3) 10V SHUTDOWN and (4) SYSTEM ERROR. For the first three alarms, the full text message will be displayed for 5 seconds, followed by an abbreviated form of the message, eg. MTR Fail, OCL Fail or 10V Fail. A timing message will also appear, documenting how long the condition has been present. The format for the time is "H:MM:SS." The SYSTEM ERROR message will always be displayed with full text. The 10V Fail message indicates that the internal 10 volt system has failed at the main board.

**NOTE:** If the cause of the SYSTEM ERROR does not allow the HT50 to display the alarm message and the Device Alert indicator to light, the ventilator will shut down and, if enabled, the Shut Down Alert Alarm will activate. Upon the next power up of the unit, the SYSTEM ERROR message will be displayed. If the cause of the alarm has been corrected, the message can be cancelled by pressing the Silence/Reset button.

Although the Device Alert messages could all be caused by hardware malfunction, the Occlusion Shutdown could also be caused by the exhalation valve tubing having a kink or obstruction. The detection criteria for an Occlusion alarm is when airway pressure is > 15 cmH<sub>2</sub>O/mbar above baseline pressure after either three seconds of exhalation, or at the beginning of the next breath.

**WARNING** If a Device Alert alarm occurs, immediately disconnect the patient from the ventilator and provide an alternate method of ventilation.

**NOTE:** A Device Alert Alarm cannot be silenced by pressing the Silence/Reset button. It is cancelled by turning the ventilator Off.

**Shut Down Alert Alarm  
(automatic)**

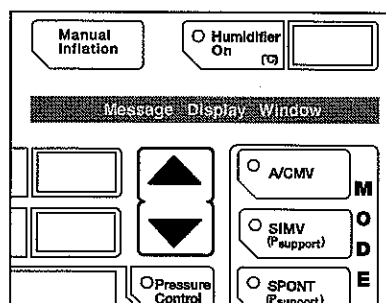
**Audible Alarm:** Intermittent beeps  
**Visual Alarm:** -  
**Message Window:** -

If selected On in User Set Up, the Shut Down Alert Alarm is triggered when the ventilator is turned Off. An intermittent audible alert indicates the ventilator is no longer operational. When on external power, the alert is a brief series of intermittent beeps that stop automatically. When on internal battery, the intermittent beeps must be silenced by pressing the Silence/Reset button.

**NOTE:** This function can be toggled on/off in User Set Up.

**WARNING** Newport recommends that the Shut Down Alert always be enabled to ensure that the user is notified should the ventilator shut down unexpectedly.

**FRONT PANEL MESSAGE DISPLAY WINDOW**



All messages and alarms are displayed in a 16 character, alpha numeric window located above the MODE controls.

**Monitoring Messages:**

When the Message Display Window is blank (no message displayed) press the ▲Up control button to scroll through the monitoring messages available. Monitored information includes volume, frequency and pressure values.

## **DESCRIPTION OF CONTROLS, INDICATORS, ALARMS & CONNECTIONS**

---

Tidal volume, peak pressure, and baseline pressure are updated breath by breath. Frequency and mean pressure are also updated breath by breath, using a 6 sec. rolling average for frequency and a 60 sec. rolling average for mean pressure. Minute volume is updated every 10 seconds using a 60 sec. rolling average.

**NOTE:** Monitoring Messages cannot be accessed during alarm violations.

There are 3 selections available:

- VT /  $\dot{V}_i$  / f
- Paw / P / M / B
- Blank Display

Press the ▲ Up button to scroll through the lines. Three seconds after selecting a line, the relevant operating parameters are displayed. Scroll to the third line, "Blank Display," to blank out or stop displaying the monitoring messages.

Following are the parameters for each line:

Line 1: "VT xxx  $\dot{V}_i$  xx f xx"

- VT – Tidal volume (in mL)
- $\dot{V}_i$  – Insp. Minute Volume (in L/min)
- f – Total number of patient or time triggered breaths detected for the last 60 seconds (in b/min)

Line 2: "Paw Pxx Mxx Bxx"

- P – Peak airway pressure of last breath
- M – Mean airway pressure
- B – Baseline airway pressure at the end of expiration

Line 3: Blank Display

### **Alarm and Caution Messages:**

All alarms have corresponding messages in the Message Display Window. See pg 2-3 for list of alarms. If more than one alarm is violated, they are displayed in order of medical priority. Alarm messages override the display of monitored parameters.

**Setting Limitation Messages:**

The following "Setting Limitation" messages are displayed to notify the user that adjustments have caused parameters to reach software defined limitations.

Reached Max $\dot{V}$ :	maximum $\dot{V}$ (flow) setting has been reached
Reached Min $\dot{V}$ :	minimum $\dot{V}$ (flow) setting has been reached
Inverse I:E:	inverse I:E ratio has been reached
Reached Max I:E:	inverse I:E ratio has reached 3:1
$\dot{V}$ Unavailable:	$\dot{V}$ display is not available in Pressure Control
Peep + PS Too High:	set PEEP + P support is higher than 60 cmH <sub>2</sub> O/mbar
PC – Peep Too Low:	Pressure Control value minus PEEP is less than 5 cmH <sub>2</sub> O/mbar
↑ – PEEP Too Low:	High Pressure limit minus PEEP is less than 5 cmH <sub>2</sub> O/mbar

The following messages are provided as "prompts" or reminders.

Panel Locked:	notifies user that the front panel buttons are now locked
PRESS AGAIN:	notifies user that a second press on the same button is required in order to confirm change requested

**LEFT SIDE CONNECTORS**

**WARNING** The round heater for the optional humidifier is located nearby the left side connectors. This heater becomes extremely hot when the humidifier is on. DO NOT TOUCH!

**Airway Pressure Connector**

AIRWAY  
PRESSURE ►

Measures proximal airway pressure. Connect the proximal pressure sensing line of the patient breathing circuit to this fitting.

**WARNING** Always use an inline filter (p/n HT6004701 or equivalent) at the Airway Pressure Connector to protect the internal pressure transducers from moisture or other contaminants.

**Gas Output Connector**

GAS  
OUTPUT ►

Supplies gas flow to the patient. Connect the patient breathing circuit to this outlet.

**Exhalation Valve Connector**

▲ EXH. VALVE

Controls the exhalation valve. Connect the exhalation valve control drive line to this outlet.

# DESCRIPTION OF CONTROLS, INDICATORS, ALARMS & CONNECTIONS

## Temperature Probe Connector

TEMP. PROBE

Electrical connector for dual-channel temperature probes which are used to measure the temperature in the humidifier water bottle and the patient breathing circuit.

## RS-232C / RS-485 Interface

COMM. PORT

An 8 pin SEMCONN connector operating at 19,200 baud which allows the ventilator system to interface with central monitoring computer systems and remote alarms.

**NOTE:** Contact your NEWPORT representative for more information regarding compatibility with specific remote monitoring systems.

## Emergency Air Intake

◀ **WARNING!**  
EMERGENCY AIR INTAKE  
DO NOT OBSTRUCT!

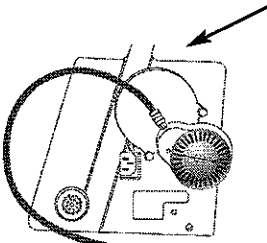
Allows the patient to pull ambient air into the breathing circuit in the event of a complete system failure. Air intake opening pressure is approximately  $-2 \text{ cmH}_2\text{O}$  ( $-2 \text{ mbar}$ ).

■ **WARNING** Do not obstruct the Emergency Air Intake! Any impediment could result in patient suffocation.

■ **WARNING HOME CAREGIVERS:** Should a complete failure of the ventilator occur, the Emergency Air Intake allows the patient to breath from room air through the intake valve. Blockage of the valve could result in suffocation. Check periodically to ensure that the valve functions correctly.

## RIGHT SIDE CONNECTORS

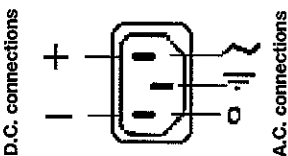
### Fresh Gas Intake And Filter Cover



Environmental air enters through this 30 mm diameter Fresh Gas Intake. The air inlet particle filter is placed behind the Filter Cover to protect the patient as well as the ventilator's piston system from dirt and particles. The Fresh Gas Intake is the attachment socket for the optional HT50 Air/Oxygen Entrainment Mixer or an Oxygen Blending Bag.

■ **WARNING** Do not block the Fresh Gas Intake.

### External Power Connector



100-240 VAC, max. 2A  
50/60/400 Hz

12-30 VDC, max. 12A

The HT50 uses a single inlet for both A.C. and D.C. power sources. The inlet power connector automatically recognizes A.C. voltage ranges from 100 to 240 and D.C. volt ranges from 12 to 30.

**WARNING** To ensure proper grounding and prevent possible shock hazards, this device should only be connected to "Hospital Grade" power receptacles.

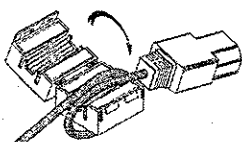
**WARNING HOME CAREGIVERS:** External power in the home environment must support min. 100 to max. 240 VAC and must have a grounded receptacle.

**Equipotential Connector**



Used for electric potential equalization.

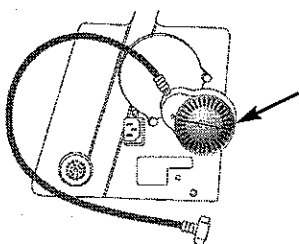
**Power Cord Ferrite**



Use of the Power Cord Ferrite ensures that the HT50 meets EMC requirements. Anytime the HT50 is operating on A.C. power, the ferrite should be attached to the power cord. Operating from D.C. power does not require the use of the ferrite.

**OPTIONAL ACCESSORIES**

**Air/Oxygen Entrainment Mixer**

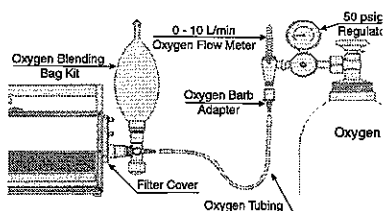


The Air/Oxygen Entrainment Mixer (p/n HT460700) is used to blend atmospheric air with medical grade oxygen at a precise ratio. A control knob allows for incremental adjustment from 0.21 to 1.00, with an accuracy of  $\pm .08$ . The high pressure oxygen hose has a standard female DISS 1240 connection. The Mixer attaches to the Fresh Gas Intake of the HT50 on the Filter Cover, located on the right side of the ventilator.

**Pneumatic Requirements**

Oxygen	35-90 psig (2.4 to 6.2 Bar)
Air	Atmospheric pressure

**Oxygen Blending Bag Kit**



The Oxygen Blending Bag Kit (p/n HT600044) is used to blend atmospheric air with a low flow (0 to 10 L/min) medical grade oxygen source. The Oxygen Blending Bag Kit attaches to the Fresh Gas Intake on the Filter Cover, located on the right side of the ventilator. This system allows the user to ventilate patients with oxygen enriched gas from 0.21 up to 1.00.

**Pneumatic Requirements**

Oxygen	0-10 L/min (calibrated)
Air	Atmospheric pressure

## **DESCRIPTION OF CONTROLS, INDICATORS, ALARMS & CONNECTIONS**

---

### **USER SET UP**

The User Set Up allows the operator to review software version and operating time information as well as select a variety of functional parameters. User Set Up parameters must be established before the HT50 is used for ventilation.

**NOTE:** HOME CAREGIVERS: The User Set Up parameters should be defined in conjunction with your physician or Homecare Dealer. Once established, these parameters are kept in memory and will be in affect each time the ventilator is powered on until the operator enters User Set Up and makes changes.

**NOTE:** To enter User Set Up the HT50 must be in the Standby or Off condition.

To access User Set Up, first press and hold the Silence/Reset button down. When the Message Display Window shows the message "USER SETUP," release the button. Sequentially, the Message Display Window displays the following: the software version, total ventilator operating hours, and finally the system set up parameters that the operator can adjust. See Table 1.

The user may scroll through the set up parameters by pressing the Int. Battery button. Use the ▲Up/▼Down control buttons to change the parameter setting. To exit User Set Up, press the Silence/Reset button once. The HT50 is now ready for use.

**NOTE:** When operating from the battery (internal or external), you must press the On/Standby button in addition to the Silence/Reset button. Press both buttons for at least one second and release when "USER SETUP" is displayed in the Message Display Window.

Parameter	Display	▲ Up/ ▼ Down (allows selection)
Headline	USER SETUP	None
Software Version	SW Version XXX	None
Operating Time	Working Hr XXX	None
Power Save	Power Save ON*	Toggles On/Off
Pressure Units	Pressure cmH <sub>2</sub> O*	Toggles cmH <sub>2</sub> O/mbar
Language	Language ENGLISH	None**
Shut Down Alert	S-Down alert ON	Toggles On/Off
Buzzer volume	Buzzer LOUD*	Toggles Loud/Quiet
Parameter Setting	Set up USER*	Toggles User/Default
Auto Panel Lock	Lock DISABLED	Toggles Enabled/Disabled
Communication Protocol	Comm: RS232	Toggles RS232/RS485
Meter Adjust	Meter Adjust	Moves Paw meter needle up and down
Exh. Valve Calibration	Valve Cal	Starts calibration and saves parameters
Technical Set Up	Tech. Setup	Refer to Section 5

\* Factory default setting. May be different if another setting was selected during the previous User Set Up.

\*\* Other languages will be available in the future.

**Table 1: User Set Up Parameters**

**NOTE:** To inquire about the latest software release for the HT50, contact NEWPORT Technical Service at 1.949.642.3910 ext. 500.

**NOTE:** Only the ▲Up/▼Down, Silence/Reset, and Int. Battery buttons are active during User Set Up.

**WARNING** Newport recommends that the Shut Down Alert always be enabled to ensure that the user is notified should the ventilator shut down unexpectedly.

## User Set Up Parameters

### Power Save

Use the ▲Up/▼Down controls to toggle the Power Save function On or Off. To conserve battery power consumption during internal battery operation, the Power Save function automatically blanks the HT50's numeric displays if the ventilator has operated for 2 minutes with no buttons pressed or alarms violated. MODE, On/Standby and Int. Battery indicators remain illuminated at all times.

## DESCRIPTION OF CONTROLS, INDICATORS, ALARMS & CONNECTIONS

---

If an alarm condition occurs, or any button is pressed, the Power Save function is suspended for 2 minutes. The Power Save feature can extend battery operating time by as much as 30%.

### Pressure Units

Selects between cmH<sub>2</sub>O and mbar as the unit used on the pressure meter and the various front panel controls. The HT50 is factory set to cmH<sub>2</sub>O. Use the ▲Up/▼Down controls to toggle to the mbar setting.

**NOTE:** For consistency, particularly in medical record keeping, it is recommended that each institution standardize to either "cmH<sub>2</sub>O" or "mbar" operation.

**NOTE:** HOME CAREGIVERS: The unit of measure, along with other parameter settings, should be established by the patient's physician or Homecare Dealer.

### Shut Down Alert

When the Shut Down Alert is selected ON, an audible alarm is triggered when the ventilator is turned OFF. An intermittent audible alert indicates the ventilator is no longer operational. The Alert is a brief series of intermittent beeps that must be silenced by pressing the Silence/Reset button.

The HT50 is factory preset with the Shut Down Alert ON. Use the ▲Up/▼Down buttons to toggle between ON and OFF.

**WARNING** Newport recommends that the Shut Down Alert always be ON to ensure that the user is notified should the ventilator shut down unexpectedly.

### Buzzer Volume

The Buzzer Volume setting allows the user to select "Quiet" or "Loud" sound volume for the audible alarms and notification beeps. The HT50 is factory preset with the Buzzer Volume set on loud. Use the ▲Up/▼Down buttons to toggle between selections.

### Parameter Setting

The Set Up parameters allow the operator to set the ventilator's start up settings. There are two selections, DEFAULT or USER. To select DEFAULT, use the ▲Up/▼Down button and toggle to DEFAULT. Factory set default parameters are listed on pg 2-6.

USER allows the operator to establish new start up parameters. When USER is selected, all of the ventilation parameters in effect at shutdown will be saved. The saved parameters will appear next time the ventilator is powered on.

**Auto Panel Lock**

This setting allows the user to enable (turn on) or disable (turn off) the Auto Panel Lock feature. For a complete description of Auto Panel Lock see pg 3-14. The Auto Panel Lock feature is factory set at Disabled or off. Use the ▲Up/▼Down buttons to toggle between Enabled and Disabled.

**NOTE:** HOME CAREGIVERS: NEWPORT recommends that the Auto Panel Lock feature be enabled in homecare environments as an added safety feature to prevent accidental changes to panel controls.

**Communication Protocol**

Selects the communication protocol, RS232 or RS485, to be used on the serial communication port. Use the ▲Up/▼Down buttons to toggle between protocol choices.

**Meter Adjust**

This setting allows the user to adjust the needle on the Paw meter. To readjust the needle to the zero position use the ▲Up/▼Down buttons to move the needle up or down.

**Exhalation Valve Calibration**

Calibrate the exhalation valve prior to use as follows:

1. Connect the HT50 patient circuit to the ventilator. Connect the exhalation valve on the patient circuit to an adult (500 mL) test lung.
2. Enter User Set Up. Use the Int. Battery button to scroll to "Valve Cal." Press the ▲Up/▼Down button to start automatic calibration.

The exhalation valve will automatically be tested by the ventilator. If it passes the test, the message "Cal Completed" will be displayed for three seconds then return to "Valve Cal."

If the test failed, the message "Cal Failed" will be displayed until the Silence/Reset button is pressed. To re-calibrate the exhalation valve, press the ▲Up/▼Down button again.

3. When calibration is finished, press Silence/Reset to exit.

**NOTE:** Improper operation of the ventilator may result if the exhalation valve is not calibrated properly. If the exhalation valve fails the calibration procedure, try another exhalation valve or use an alternate method of ventilation and contact your Homecare Dealer or NEWPORT.

**Exiting User Set Up**

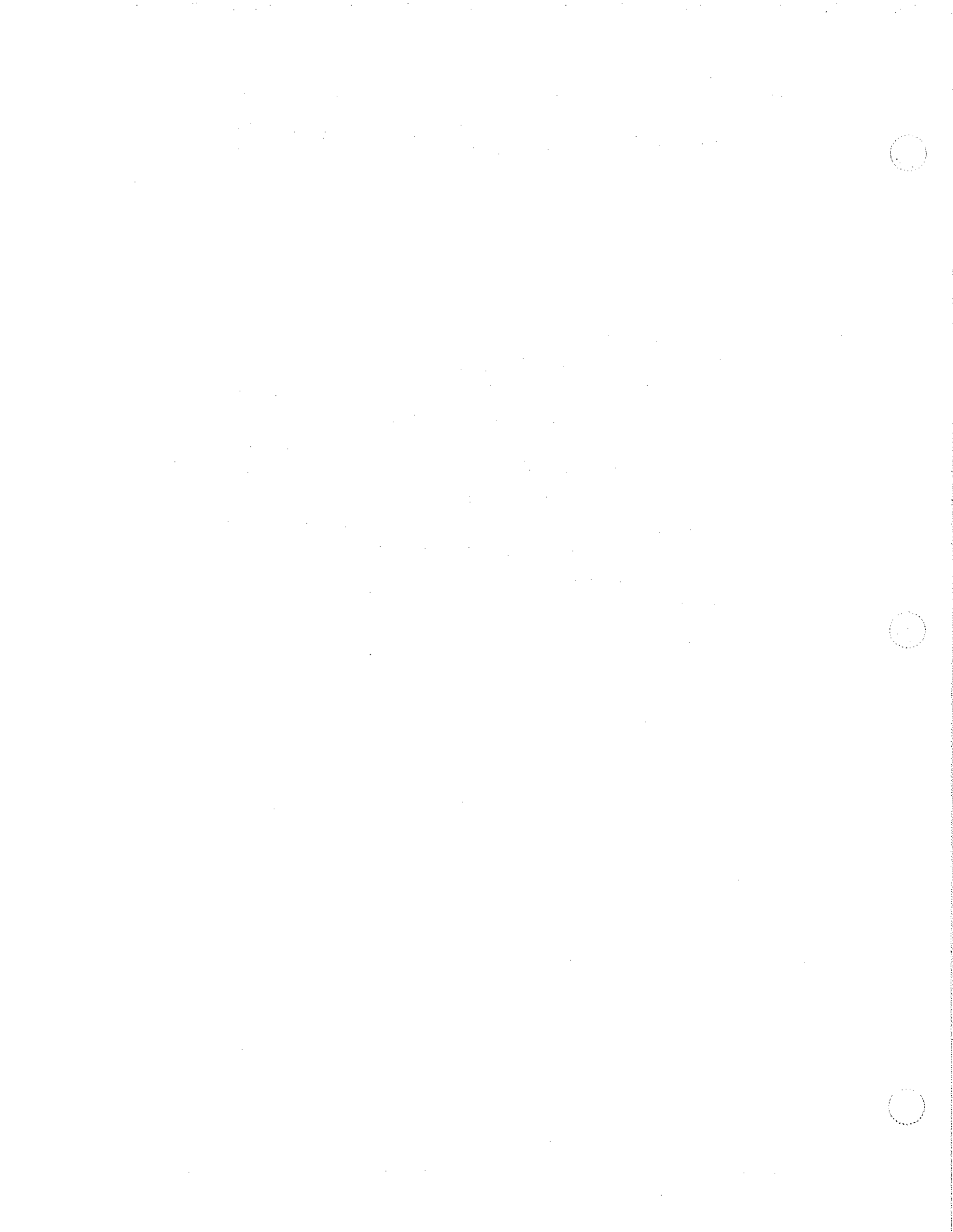
User Set Up can be exited by pressing the Silence/Reset button any time during the User Set Up procedure.



---

## 4. THEORY OF OPERATION

General System Overview . . . . .	4-1
A/CMV Mode (Assist/Control Mandatory Ventilation) . . . . .	4-2
SIMV Mode (Synchronized Intermittent Mandatory Ventilation) . . . . .	4-2
SPONT Mode (Spontaneous Ventilation) . . . . .	4-3
Psupport (Pressure Support) . . . . .	4-3
Pressure Control (Pressure Control Ventilation) . . . . .	4-4
Volume Control (Volume Control Ventilation) . . . . .	4-4
Back-Up Ventilation . . . . .	4-5



## GENERAL SYSTEM OVERVIEW

The NEWPORT HT50 Ventilator is an electrically powered, microprocessor controlled ventilator with pressure support for spontaneous breathing. It can be pressure or time triggered, volume or pressure limited, time, pressure or flow cycled. Back up ventilation is available, manual inflation is possible, and there is emergency intake valve which allows the patient to pull ambient air into the breathing circuit in the event of a complete loss of supply gas pressure. Opening pressure is approximately  $-2 \text{ cmH}_2\text{O}$  ( $-2 \text{ mbar}$ ) during emergency intake. An internal lead acid rechargeable battery powers the ventilator for up to 10 hours when fully charged.

The electronic control system includes a central microprocessor that is responsible for all electrically activated mechanical components. Another microprocessor on the panel board controls the airway pressure meter and all electronic displays. The main component of the pneumatic system is an electrically controlled pump. This pump provides a compressed gas source so no external air compressor is needed. Additionally, the exhalation valve is activated by an electrically controlled proportional solenoid.

The NEWPORT HT50 is designed to ventilate pediatrics (body weight  $\geq 10 \text{ kg}$ ) and adults.

**NOTE:** All versions of the HT50, the HT50-H and HT50-H1 for home/hospital use and the HT50-T for transport use, function the same. The only difference is that the HT50-T meets or exceeds required transport testing.

**NOTE:** The HT50-T is the only version of the HT50 Ventilator that has been tested and approved for transport applications.

**WARNING** Although the HT50 is indicated for pediatric ventilation, it should not be used on patients with body weights under  $10 \text{ kg}$  (22 pounds).

**NOTE:** When the HT50 is used in a home care environment it is important that the primary caregiver has received training and has demonstrated competency in all equipment functions. A specific written care plan must be established by the attending physician.

**NOTE:** Transport of patients with the HT50 (p/n HT50-T) requires that medical staff have a good working knowledge of the ventilator's use and problem resolution. Proper emergency back-up equipment must be immediately available during transport.

## THEORY OF OPERATION

---

### **A/CMV MODE (Assist/Control Mandatory Ventilation)**

In A/CMV mode, time triggered (mandatory) breaths are delivered in accordance with the  $f$  setting. Patients can trigger mandatory breaths in addition to, or in place of, time triggered (mandatory) breaths if the effort they generate causes airway pressure to meet the P<sub>trig</sub> setting. Every such patient effort results in a mandatory breath. The breath can be volume or pressure controlled. PEEP/CPAP may be added. Tidal volume is determined by the target pressure,  $t_i$ , and patient respiratory mechanics in Pressure Control and by the tidal volume setting in Volume Control.

As with all HT50 operating modes, Back-up Ventilation is activated if the Low  $\nabla V_i$  alarm is violated.

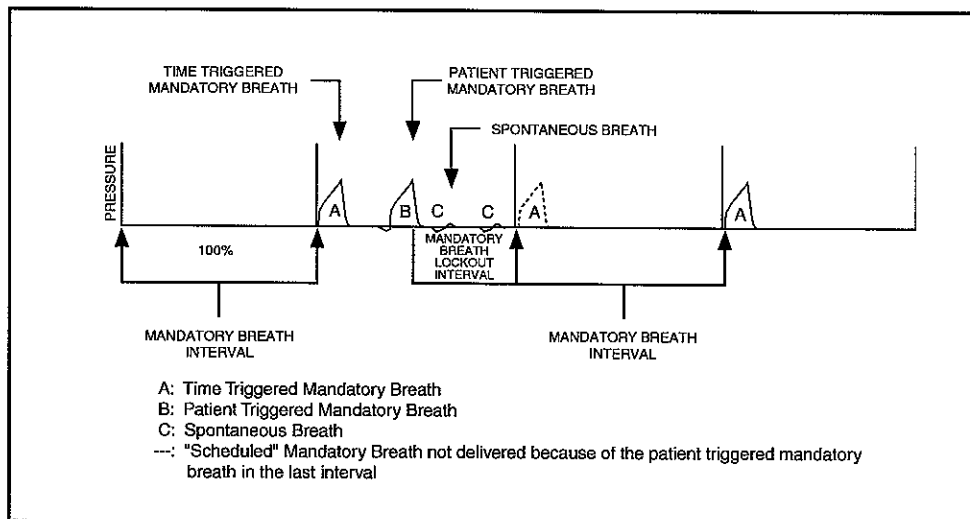
### **SIMV MODE (Synchronized Intermittent Mandatory Ventilation)**

In SIMV mode, patients receive a fixed number of volume or pressure controlled mandatory breaths (time or patient triggered) and may breathe spontaneously between mandatory breaths, with or without pressure support (P<sub>support</sub>). See Figure 4-1 for schematic illustration. PEEP/CPAP may be added.

The first breath in any mandatory breath interval should be a patient triggered mandatory breath. The patient has the rest of the interval to breathe spontaneously. If the patient does not trigger the ventilator, and one complete mandatory breath interval has elapsed, a time triggered (mandatory) breath is delivered.

A mandatory breath lockout interval is activated whenever the patient triggers a mandatory breath. This limits the number of mandatory breaths (time triggered or patient triggered) the patient receives in 60 seconds to the  $f$  (b/min) setting.

As with all HT50 operating modes, Back-up Ventilation is activated if the Low  $\nabla V_i$  alarm is violated.



**Figure 4-1**  
**Volume Controlled, Synchronized Intermittent Mandatory Ventilation (SIMV)**  
**(without Pressure Support)**

## SPONT MODE (Spontaneous Ventilation)

In SPONT mode, mandatory breaths are not delivered but the user can adjust both PEEP/CPAP and pressure support (P support) levels. The patient has control over each breath.

When PEEP/CPAP is set above 0, the ventilator mode is CPAP (without P support) or Bi-level Positive Airway Pressure (with P support). Ensure that P<sub>trig</sub> is set so the HT50 detects all spontaneous patient efforts.

Entries for tidal volume,  $f$ ,  $t_i$  and Low Paw alarm are all inactive in SPONT mode. However, users can preset these parameters for future A/CMV or SIMV operation.

As with all HT50 operating modes, Back-up Ventilation is activated if the Low  $\nabla V_i$  alarm is violated.

## PSUPPORT (Pressure Support)

P support only functions during patient triggered spontaneous breaths in SIMV and SPONT modes. During each spontaneous breath, the ventilator supports the patient by elevating the airway pressure to the P support + PEEP level. Breaths are terminated when (1) flow to the patient drops to 25% of that breath's peak flow rate, or (2) the target airway pressure is exceeded by 3 cmH<sub>2</sub>O, or (3) after 3 seconds of inspiration. Maximum airway pressure never exceeds the High  $\blacktriangle$  Paw alarm setting.

## THEORY OF OPERATION

---

### PRESSURE CONTROL (Pressure Control Ventilation)

The HT50 targets and maintains patient airway pressure at the set pressure control level throughout inspiration. Breath termination occurs when (1) the set  $t_i$  elapses, or (2)  $P_{aw}$  exceeds the Pressure Control setting by 8 cmH<sub>2</sub>O. Maximum airway pressure never exceeds the user set High  $\blacktriangle$   $P_{aw}$  alarm setting.

**NOTE:** The target airway pressure for pressure controlled mandatory breaths in A/CMV and SIMV is the display setting above ambient pressure, not above PEEP.

Both time and patient triggered mandatory breaths can be delivered in A/CMV and SIMV Pressure Control operation. During SIMV Pressure Control operation, patients can breathe spontaneously between mandatory breaths with or without pressure support.

**NOTE:** When disconnecting the patient circuit during PCV/PSV ventilation, i.e. for suctioning, the flow may increase in order to compensate for the low pressure. After reconnecting the patient circuit, press the PCV/PSV button twice to quickly re-adjust flow to a lower level.

### VOLUME CONTROL (Volume Control Ventilation)

During Volume Control ventilation, tidal volume can be set for mandatory breaths. If a volume setting is changed while the ventilator is operating, the change takes place in increments over a series of breaths.

When tidal volume is adjusted, inspiratory time remains constant and  $\dot{V}$  (mandatory flow) changes.

If an attempted tidal volume setting results in a flow rate in excess of 100 L/min or less than 6 L/min, adjustment ceases and the user is alerted by an audible beep and the message "Reached Max  $\dot{V}$ " or "Reached Min  $\dot{V}$ " will appear in the Message Display Window.

## BACK-UP VENTILATION

Back-up Ventilation is an alarmed function that activates when the delivered inspiratory minute volume ( $\dot{V}_I$ ) falls below the Low  $\nabla\dot{V}_I$  alarm setting. During Back-up Ventilation, the Low  $\nabla\dot{V}_I$  (Back-up Vent) alarm indicator blinks, an audible alarm sounds, and "Low  $\dot{V}_I$  (BUV)" is displayed in the Message Display Window. The ventilation settings employed by Back-up Ventilation are displayed on the front panel.

Back-up Ventilation is functional in all modes.

**NOTE:** Back-up Ventilation is not active for 60 seconds after the user adjusts any ventilator controls, changes modes or turns the ventilator On from the Setting condition.

**NOTE:** During Back-up Ventilation, the Silence/Reset button can be pressed to silence the audible alarm. This will not cancel Back-up Ventilation.

**NOTE:** Back-up Ventilation in the HT50 is based on the delivered inspiratory minute volume. The inspiratory minute volume may be different from the expiratory minute volume in some conditions, such as in the case of a patient breathing circuit or patient airway leak.

### ***Back-up Ventilation in A/CMV and SIMV Modes:***

(Back-up Ventilation parameters are indicated on the front panel displays.)

In A/CMV or SIMV modes, mandatory breath frequency increases by 1.5 times the frequency ( $f$ ) setting, up to a maximum of 99 b/min. The minimum breath frequency delivered is 15 b/min.

The frequency ( $f$ ) will only increase up to a rate that produces a 1:1 I:E ratio even if the calculated Back-up Ventilation rate is higher.

### ***Back-up Ventilation in SPONT Mode:***

(Back-up Ventilation parameters are indicated on the front panel displays.)

In SPONT mode, the MODE changes from SPONT to SIMV, Pressure Controlled ventilation, mandatory breath frequency ( $f$ ) = 15 b/min., peak inspiratory pressure = 15 cmH<sub>2</sub>O/mbar above set PEEP and inspiratory time ( $t_i$ ) = 1.0 sec.

### ***Cancellation of Back-up Ventilation***

#### ***User Cancelled***

If during Back-up Ventilation, the user adjusts any ventilation parameter, Back-up Ventilation is suspended for one minute and

## THEORY OF OPERATION

---

all user selected ventilation parameters are employed. Another 60 seconds must pass after parameter adjustments before a  $\nabla V_I$  alarm will result in Back-up Ventilation.

### ***HT50 Cancelled***

If delivered inspiratory minute volume exceeds the Low  $\nabla V_I$  alarm setting by 10%, Back-up Ventilation is cancelled, the audible alarm stops, the Low  $\nabla V_I$  (Back-up Vent) alarm indicator latches and the HT50 resumes ventilation at the user-selected parameters.

Press the Silence/Reset button to cancel the latched alarm indicator and alarm message in the Message Display Window.

---

## 5. CALIBRATION AND OPERATIONAL VERIFICATION PROCEDURE (OVP)

Introduction .....	5-1
Test Equipment Required .....	5-1
Pre-Test Inspection .....	5-2
Front Panel Test / Alarm Check.....	5-2
Pressure Transducer Calibration .....	5-3
Pressure Meter Calibration .....	5-4
Volume Factor Calibration .....	5-5
Pressure Relief Valve Calibration.....	5-5
Exhalation Valve Calibration .....	5-6
Operational Set-Up (Standard Test Settings) .....	5-6
Pressure Verification .....	5-7
P trig.....	5-7
PEEP / CPAP .....	5-8
Pressure Control .....	5-8
Exhalation Valve Sealing .....	5-8
Manual Inflation .....	5-9
Respiratory Rate .....	5-9
Inspiratory Time .....	5-9
High Paw Alarm .....	5-9
Low Paw Alarm .....	5-10
High Minute Volume Alarm .....	5-10
Low Minute Volume Alarm.....	5-10
Check Prox Line Alarm .....	5-10
Apnea Alarm.....	5-11
Battery Test .....	5-11
System Leak Test.....	5-11
Humidifier (for HT50-H) .....	5-12
OVP Test Record .....	5-13



## INTRODUCTION

This procedure is intended to assist a Newport authorized service technician to establish a routine verification program to verify proper operation of the HT50 Ventilator (p/n HT50-H, HT50-H1 and HT50-T). An OVP must be performed each time the ventilator is serviced or a minimum of once a year.

**WARNING** Do not use the ventilator if it does not pass the Operational Verification Procedure.

## TEST EQUIPMENT REQUIRED

20 cc syringe with Luer lock

HT50 adult reusable breathing circuit with exhalation valve

500 cc Test Lung that will function at 90 cmH<sub>2</sub>O/mbar or equivalent

Parabolic resistor Rp50 (p/n RP50)

Calibrated manometer or pressure gauge  
(range: 0 to 100 cmH<sub>2</sub>O/mbar)

T-connector (p/n TOL200A)

Humidifier bottle and probe (for HT50-H with humidifier)

Vacuum gauge (0-120 mmHg minimum)

Stop watch or equivalent

**Caution** The accuracy of any test equipment should be annually certified by a testing laboratory before use. Take calibration data into account.

**NOTE:** Make a copy of the Test Record at the end of this section and check off each test as it is performed.

**NOTE:** Audible alarms will activate periodically while performing some tests. You may silence the alarm by pushing the Silence/Reset button.

**NOTE:** After every setup parameter change, wait a few breaths to allow the ventilator to stabilize before recording values.

# CALIBRATION/OPERATIONAL VERIFICATION PROCEDURE

---

## PRE-TEST INSPECTION

Refer to Figure 9-1.

### 1. General Inspection

- Inspect the patient breathing circuit, exhalation valve, and 500 cc test lung for any deterioration which may cause leaks in the system. Replace any defective parts prior to performing the OVP.
- Inspect the A.C. power cord for any deterioration. Replace the power cord as necessary.
- Inspect the proximal filter. If filter housing indicates the presence of dirt or moisture, replacement of the filter is necessary.

**WARNING** DO NOT reverse filters. This practice could allow for contaminants to enter the breathing circuit or ventilator. Dirty or contaminated filters must always be replaced with new filters.

### 2. Air Inlet Filter

- Remove the Air Inlet Filter Cover (8).
- Inspect the inlet filter (11). If the filter material indicates the presence of dirt or is discolored, replacement of the filter is necessary.
- Before reinstalling the Inlet Filter Cover, make certain that the filter is lying flat within the counterbore of the cover.
- Reinstall the Cover, making certain that the filter material remains securely in place.

### 3. Connecting Breathing Circuit, Exhalation Valve, and Test Lung

- Connect the one end of the patient tubing to the main flow outlet labeled "GAS OUTPUT" (bypassing any humidifier) and the other end to the exhalation valve. Connect one end of the exhalation drive line tubing to the connector labeled "EXH. VALVE" and the other end to the white connector on the exhalation valve. Connect one end of the proximal pressure tubing to the connector labeled "AIRWAY PRESSURE" (via the proximal inline filter) and the other end to the blue connector on the exhalation valve.
- Connect the 500 cc test lung to the exhalation valve.

**NOTE:** The proximal filter must remain inline for all calibrations and tests.

## FRONT PANEL TEST/ALARM CHECK

1. Connect the ventilator to A.C. power.
2. Press the On/Standby button once. The ventilator performs a self-test and then switches to the Settings condition. During the self-test, verify operation of the audible alarm and all LED indicators, numeric and alphanumeric displays. Verify that:
  - All single color and dual color indicator LEDs are functional and are at the same intensity.
  - All 7-segment LEDs are functional.
3. Press all buttons and verify that all buttons are functional and can be operated with the same force.
4. Place the ventilator in the Standby condition by pressing the On/Standby button twice.

## PRESSURE TRANSDUCERS CALIBRATION

1. Connect the T-connector between the patient fitting on the exhalation valve and a test lung. Connect the small bore tubing from the T-connector to the calibrated pressure gauge.
2. While in the Standby condition, enter USER SETUP by pressing and holding the Silence/Reset button until the Message Display Window shows "USER SETUP," then release the button.

**NOTE:** Upon entering USER SETUP the Message Display Window will display the current software version of the unit and operating hours since last maintenance. Enter the software version number and hours on the test record.

3. Use the Int. Battery button to scroll to the "Tech. Setup" message. Use the ▲Up control button to select this parameter. When the Message Display Window displays "Enter Code...", press the *f* button then the A/CMV button within 5 seconds.
4. The Message Display Window will display "Pressure Cal."
5. Press the ▲Up control button and the Message Display Window will display "Apply Zero Pressure." Make sure that the calibrated pressure gauge shows zero pressure. If pressure > 0, remove breathing circuit to relieve pressure.

## **CALIBRATION/OPERATIONAL VERIFICATION PROCEDURE**

---

6. Press the Int. Battery button. The system will start the motor and will inflate the test lung. The Message Display Window will show "Pressure = 60.0" (60 is the default value). Adjust the displayed value in the Message Display Window on the ventilator using the ▲Up/▼Down control buttons so that it shows the same value as the calibrated pressure gauge. The value should be between 40 and 90.
7. Press the Int. Battery button again. After a couple of seconds you will see two pressure values displayed: P1 = X and P2 = X (X is the pressure value). After a few seconds the Message Display Window will show the message "Pressure Cal." You are now ready to repeat the calibration.
8. Repeat steps 5 through 7, this time making note of the P1 and P2 values. These two numerical values should be within 1.5 of each other. If the difference is within an acceptable range, you are ready to exit "Tech. Setup." If they are not, repeat calibration until the values are within this range.
9. Remove the T-connector and 500 cc test lung.

## **PRESSURE METER CALIBRATION**

1. Use the Int. Battery button to scroll to "Meter Cal."
2. Press the ▲Up control button to select "Meter Cal." The Message Display Window will display "Adjust to 0."
3. Use the ▲Up/▼Down control buttons to adjust the Paw needle to 0.
4. Press the Int. Battery button and the Message Display Window will display "Adjust to 60."
5. Use the ▲Up/▼Down control buttons to adjust the Paw needle to 60.
6. Press the Int. Battery button and the Message Display Window will display "Verification" and will then cycle the Paw meter needle to 0, 30, 60 and 90. The needle should be within 4 at each setting. If it is not, complete step 7 then repeat steps 1-6.
7. Press the Int. Battery button to exit "Verification." The routine will exit after reaching 90, and the display will return to "Meter Cal."

## VOLUME FACTOR CALIBRATION

1. Use the Int. Battery button to scroll to "Set Vol Factor."
2. Press the ▲Up control button. The Message Display Window will display "Connect Rp50."
3. Connect an Rp50 parabolic resistor to the patient end of the exhalation valve and leave the other side of the resistor open to air. **MAKE SURE IT IS NOT BLOCKED IN ANY WAY.**
4. Press the ▲Up control button again and the system will start the motor. After the motor stops the Message Display Window will display "Vol Factor=XXX." Valid numbers are between 80-120. Record the value on the test sheet.
5. Press the Int. Battery button. Press the ▲Up control button.
6. Repeat step 4. If the Volume Factor is not within  $\pm 5$  of the previous value and within the range of 80-120, repeat steps 2-6 until two consecutive calibration procedures produce Vol Factor  $\pm 5$  of each other and both are between 80 and 120.
7. Press the Int. Battery button to exit the Volume Factor Calibration.

## PRESSURE RELIEF VALVE CALIBRATION

1. Use the Int. Battery button to scroll to "Adjust Rel Valve."
2. Block the outlet of the Rp50, and press the ▲Up control button. This will start the motor and pressure in the system will begin to rise.
3. Verify there is no air leaking from the exhalation valve. All air leakage must be from the pressure relief valve.

If no leakage is noted, proceed to step 4. If leakage is noted, you will need to pressurize the exhalation valve from an external source. While the motor continues to run, perform the following:

- Disconnect the exhalation valve tubing from the EXH.VALVE connector on the ventilator.
- Connect this same tubing to the luer connector on the 20 cc syringe.
- Pressurize the exhalation valve diaphragm by pushing on the syringe plunger until the leakage from the exhalation valve ceases.

## **CALIBRATION/OPERATIONAL VERIFICATION PROCEDURE**

---

4. The Message Display will indicate the circuit pressure. Verify that the displayed pressure is  $110 \pm 10$ .
5. If the pressure is outside this limit, use a Phillips screwdriver to adjust the pressure by turning the pressure relief screw located on the underside of the Mainflow Outlet Assembly.
6. After verifying that the Message Display Window is showing  $110 \pm 10$ , unblock the outlet of the Rp50, and press the Int. Battery button.

**NOTE:** If the 20 cc syringe was used, remove it now and reconnect the exhalation valve tubing to the exhalation valve connector.

**NOTE:** If the pressure relief valve was adjusted, recalibrate the pressure transducers per previous Pressure Transducer Calibration.

7. To exit Tech. Setup and to return to USER SETUP, press the Silence/Reset button.

## **EXHALATION VALVE CALIBRATION**

1. Use the Int. Battery button to scroll to "Valve Cal" in the USER SETUP menu.
2. Remove the Rp50 resistor from the exhalation valve. Connect the 500 cc test lung to the exhalation valve. Press the ▲Up control button to start the calibration of the exhalation valve.
3. When the calibration is completed, the system will indicate success by displaying "Cal Completed" in the Message Display Window, or failure by displaying the message "Cal Failed." If the calibration failed, repeat the procedure after verifying that all tubing connections are intact.
4. Press the Silence/Reset button to exit USER SETUP and return to Setting condition.

## **OPERATIONAL SET-UP**

1. Connect the 500 cc test lung to the patient connection on the exhalation valve.
2. If testing model HT50-H (w/ humidifier), the humidifier should no longer be bypassed. The patient circuit should be connected to the output of the humidifier chamber and the humidifier tubing should be connected between the input to the humidifier chamber and the connector on the ventilator labeled "GAS OUTPUT."

- With the ventilator in the Standby condition, press the On/Standby button once to enter Setting condition. Adjust controls to the following Standard Test Settings:

<b>MODE</b>	<b>A/CMV</b>
Volume Control	500 mL
$t_i$	1.0 sec
$f$	15 b/min
P trig	1 cmH <sub>2</sub> O/mbar
Paw alarm	3 cmH <sub>2</sub> O/mbar $\nabla$ Paw / 99 cmH <sub>2</sub> O/mbar $\triangle$ Paw
$\dot{V}_I$ alarm	1 L/min min $\nabla$ / 50 L/min max $\triangle$
PEEP/CPAP	0 cmH <sub>2</sub> O/mbar
P support	0 cmH <sub>2</sub> O/mbar
Humidifier	Off

## PRESSURE VERIFICATION

- Connect the T-connector between the test lung and the exhalation valve. Connect the tubing from the T-connector to a calibrated pressure gauge.
- Press the  $\triangle$ Up control button to select "Paw P M B" in the Message Display Window. Press the On/Standby button to begin ventilation.

**NOTE:** Whenever an alarm message is in the Message Display Window, the user cannot select pressure or volume measurements for display.

- Set  $t_i$  to 2.0 seconds. Verify that the peak pressure displayed on both the calibrated pressure gauge and the Message Display Window (i.e. "P") are within 10% of each other.
- Leave calibrated pressure gauge connected.

## P trig

- Set  $t_i$  to 1.0 second and set  $f$  to 1 b/min. Trigger breaths by squeezing the test lung hard enough to create a negative pressure equal to or greater than 1 cmH<sub>2</sub>O/mbar. Verify the P trig indicator blinks and the ventilator delivers a mandatory breath with each successful squeeze of the test lung.
- Set  $f$  to 15 b/min and P trig to 0.2 cmH<sub>2</sub>O/mbar. Verify that there is no auto-triggering.

## **CALIBRATION/OPERATIONAL VERIFICATION PROCEDURE**

---

### **PEEP / CPAP**

1. Connect the Rp50 parabolic resistor between the T-connector and the test lung.
2. Set Volume Control to 250 mL, PEEP to 5, and Ptrig to 1.0. After a few breaths, verify that the baseline pressure measurements for the Paw meter and the Message Display Window are both  $5 \pm 1$  cmH<sub>2</sub>O/mbar. If necessary, increase Ptrig level until there is no auto triggering. Verify the Ptrig level does not exceed 1.5 cmH<sub>2</sub>O/mbar.
3. Set PEEP to 15. After a few breaths, verify that the baseline pressure measurements for the Paw meter and the Message Display Window are both  $15 \pm 2$  cmH<sub>2</sub>O/mbar. If necessary, increase Ptrig level until there is no auto triggering. Verify the Ptrig level does not exceed 2 cmH<sub>2</sub>O/mbar.

### **PRESSURE CONTROL**

1. Set ventilator to Standard Test Settings.
2. Press the Pressure Control button, then adjust the Pressure Control setting to 15 cmH<sub>2</sub>O/mbar. Set t<sub>1</sub> to 3.0 seconds.
3. Verify both the Message Display Window and the calibrated pressure gauge indicate  $15 \pm 2$  cmH<sub>2</sub>O/mbar.
4. Set Pressure Control to 30 cmH<sub>2</sub>O/mbar. Verify the Message Display Window and the calibrated pressure gauge indicate  $30 \pm 3$  cmH<sub>2</sub>O/mbar.
5. Remove T-connector, leaving the Rp50 inline.

### **EXHALATION VALVE SEALING**

1. Set the HT50 to Standard Test Settings. Set the *f* to 5.
2. Change the Volume Control setting so that the Paw meter reaches  $70 \pm 5$  cmH<sub>2</sub>O/mbar during inspiration.
3. Verify there is no gas leakage from the exhalation valve during inspiration.

## MANUAL INFLATION

1. Set ventilator to the Standard Test Settings. Set  $f$  to 1. Press and release the Manual Inflation button.
2. Verify that a manual inflation occurs each time the Manual Inflation button is pressed. Verify inflation is terminated when the button is released. Set  $f$  to 15.

## RESPIRATORY RATE

1. Using a stop watch and with  $f$  set to 15 b/min, verify a mandatory breath is delivered every  $4.0 \pm 0.5$  seconds.
2. Set  $f$  to 30 b/min, then verify a mandatory breath is delivered every  $2.0 \pm 0.1$  seconds.
3. Set  $f$  to 5 b/min, then verify a mandatory breath is delivered every  $12 \pm 0.5$  seconds.

## INSPIRATORY TIME

1. Using a stop watch and with  $t_i$  set to 1.0 second, verify the duration of each mandatory inspiration is  $1.0 \pm 0.1$  seconds.
2. Set  $t_i$  to 2.0 seconds, then verify the duration of mandatory inspiration is  $2.0 \pm 0.1$  seconds.
3. Set  $t_i$  to 3.0 seconds, then verify the duration of mandatory inspiration is  $3.0 \pm 0.1$  seconds.
4. Set ventilator to Standard Test Settings.

## HIGH ▲Paw ALARM

1. Set High ▲Paw alarm to 20 cmH<sub>2</sub>O/mbar. Verify that (1) an audible and visual High ▲Paw alarm occurs, (2) inspiration is terminated, and (3) maximum pressure displayed on the Paw meter is  $20 \pm 4$  cmH<sub>2</sub>O/mbar.
2. Set the High ▲Paw back to 99 cmH<sub>2</sub>O/mbar and press the Silence/Reset button to clear the visual alarm.

## CALIBRATION/OPERATIONAL VERIFICATION PROCEDURE

---

### LOW $\nabla P_{aw}$ ALARM

1. Disconnect the test lung from the breathing circuit and verify that after 2 breaths, both an audible and visual Low  $\nabla P_{aw}$  Alarm occurs.
2. Attach the test lung to the breathing circuit and verify that the audible alarm ceases. Press the Silence/Reset button to clear the visual alarm.

### $\blacktriangle V_I$ HIGH MINUTE VOLUME ALARM

1. Set the  $\blacktriangle V_I$  High Minute Volume Alarm to 8 L/min, then set the  $f$  (frequency) to 20 b/min. Verify that an audible and visual  $\blacktriangle V_I$  High Minute Volume Alarm occurs.
2. Set the  $f$  back to 15 b/min and verify that the audible alarm ceases after minute volume falls below the alarm limit.
3. Press the Silence/Reset button to clear the visual alarm, then set the  $\blacktriangle V_I$  High Minute Volume Alarm back to 50 L/min.

### $\blacktriangledown V_I$ LOW MINUTE VOLUME ALARM

1. Set the  $\blacktriangledown V_I$  Low Minute Volume Alarm to 6 L/min, then set the  $f$  to 8 b/min. Verify that after several breaths, both an audible and visual  $\blacktriangledown V_I$  Low Minute Volume Alarm occur.
2. Verify that shortly after the alarm, Back-up ventilation is implemented and that the Message Display Window indicates "LOW  $V_I$  (BUV)."
3. As Back-up ventilation increases the minute ventilation, verify that the audible alarm ceases and Back-up Ventilation is suspended when minute ventilation increases above the  $\blacktriangledown V_I$  Low Minute Volume Alarm by 10%.
4. Press the Silence/Reset button to clear the visual alarm. Set  $f$  to 15 b/min and the  $\blacktriangledown V_I$  Low Minute Volume Alarm to 1 L/min.

### CHECK PROX LINE ALARM

1. Disconnect the Proximal Airway Pressure Line at the ventilator connection and verify that both an audible and visual Check Prox Line Alarm occurs.

2. Reconnect the Proximal Airway Pressure Line to the ventilator. Verify that the audible alarm ceases. Press the Silence/Reset to clear the visual alarm.

## **APNEA ALARM**

1. Set the Mode to SPONT and verify that after 30 seconds an audible and visual Apnea Alarm occurs.
2. Set the Mode back to A/CMV and press the Silence/Reset button to clear the visual alarm.

## **BATTERY TEST**

**NOTE:** Before proceeding with this test, ensure that the HT50 has been connected to an external power source for the purpose of charging the Int. Battery.

1. Press and hold the Int. Battery button. Verify the charge level on the Paw meter is in the blue area, and there is no "Charge Fault" message in the Message Display Window.
2. Disconnect the A.C. power cord, verify the "Ext. Power" visual and audible alarm occurs, the charging indicator illuminates red, the Int. Battery indicator turns on, and "No Ext. Power" message is displayed in the Message Display Window.
3. Silence the alarm. Press and hold the Int. Battery button. Verify the charge level on the Paw meter is in the blue area.
4. Reconnect the AC. power cord, verify the Int. Battery LED turns off and the Ext. Power LED indicator changes to green.
5. Repeat steps 2-4, allowing 90 seconds to elapse prior to reconnecting to AC power. Verify the HT50 switches back to A.C. power approximately 30 seconds later.

## **SYSTEM LEAK TEST**

1. Set the HT50 to Standard Test Settings.
2. Tighten the 3 thumbscrews of the inlet filter cover in order to ensure no leakage around the cover.
3. Connect the vacuum (negative pressure) gauge to the gas inlet.

## **CALIBRATION/OPERATIONAL VERIFICATION PROCEDURE**

---

4. Start ventilation. The required pressure reading must be 120 mmHg or greater. A failed test is characterized by either (1) failing to achieve 120 mmHg negative pressure, or (2) a rapid drop in the vacuum during exhalation.

**NOTE:** During exhalation phase, a decrease in negative pressure on the negative pressure gauge is normal.

### **HUMIDIFIER (for HT50-H)**

1. Connect the temperature probe to the ventilator. Attach an empty humidifier bottle to the ventilator (no water or heat sink).
2. Use the HT50 On/Standby button to enter the Settings condition. Press the Humidifier On button and adjust the set target temperature to 39 °C. Press the Humidifier On button to accept.
3. Verify the continuously displayed temperature is stable and is approximately room temperature for at least 5 seconds.
4. Use the HT50 On/Standby button to enter the ON condition. Verify the continuously displayed temperature is stable and is approximately room temperature for at least 5 seconds.
5. Disconnect the humidifier bottle. Verify that the audible and visual "Humidifier Fail" alarm occurs.
6. Reconnect the humidifier bottle. Clear the alarm message by pressing the Silence/Reset button. Press the Humidifier On button.
7. Disconnect the temperature probe from the Temp Probe inlet jack beneath the Mainflow Outlet Manifold. Verify that the audible and visual "Temp Probe" alarm occurs.
8. Reconnect the temperature probe. Clear the alarm message by pressing the Silence/Reset button.
9. Remove the humidifier bottle and replace the heat sink. Reinstall the bottle on the HT50.

## TEST RECORD FOR HT50

Hospital/Organization \_\_\_\_\_  
 Serial No. \_\_\_\_\_ Software Version \_\_\_\_\_ Hour Meter \_\_\_\_\_  
 HT50-T \_\_\_\_\_ HT50-H \_\_\_\_\_ HT50-H1 \_\_\_\_\_  
 Tested By \_\_\_\_\_ Date \_\_\_\_\_  
 Released By \_\_\_\_\_ Date \_\_\_\_\_

OVP TESTS	PASS	REMARKS
Pre-Test Inspection		
Front Panel Test		
Pressure Calibration		
Pressure Meter Calibration		
Volume Calibration	Volume factor = _____	
Pressure Relief Calibration		
Exhalation Valve Calibration		
Pressures Verification		
P trig		
PEEP / CPAP		
Pressure Control		
Exhalation Valve Sealing		
Manual Inflation		
Respiratory Rate		
Inspiratory Time		
High Paw Alarm		
Low Paw Alarm		
High Minute Volume Alarm		
Low Minute Volume Alarm		
Check Prox Line Alarm		
Apnea Alarm		
Battery Test		
System Leak Test		
Humidifier (For HT50-H)		

## TEST EQUIPMENT IDENTIFICATION

ID NO.

Calibration Analyzer	
Oxygen Analyzer	
Electrical Safety Analyzer	
Digital Multimeter	

## ELECTRICAL SAFETY TEST

COMMENTS

TEST	TOLERANCE	ACTUAL	COMMENTS
Ground Resistance	< 1.5 $\Omega$		
Maximum Leakage	< 300 $\mu$ A		

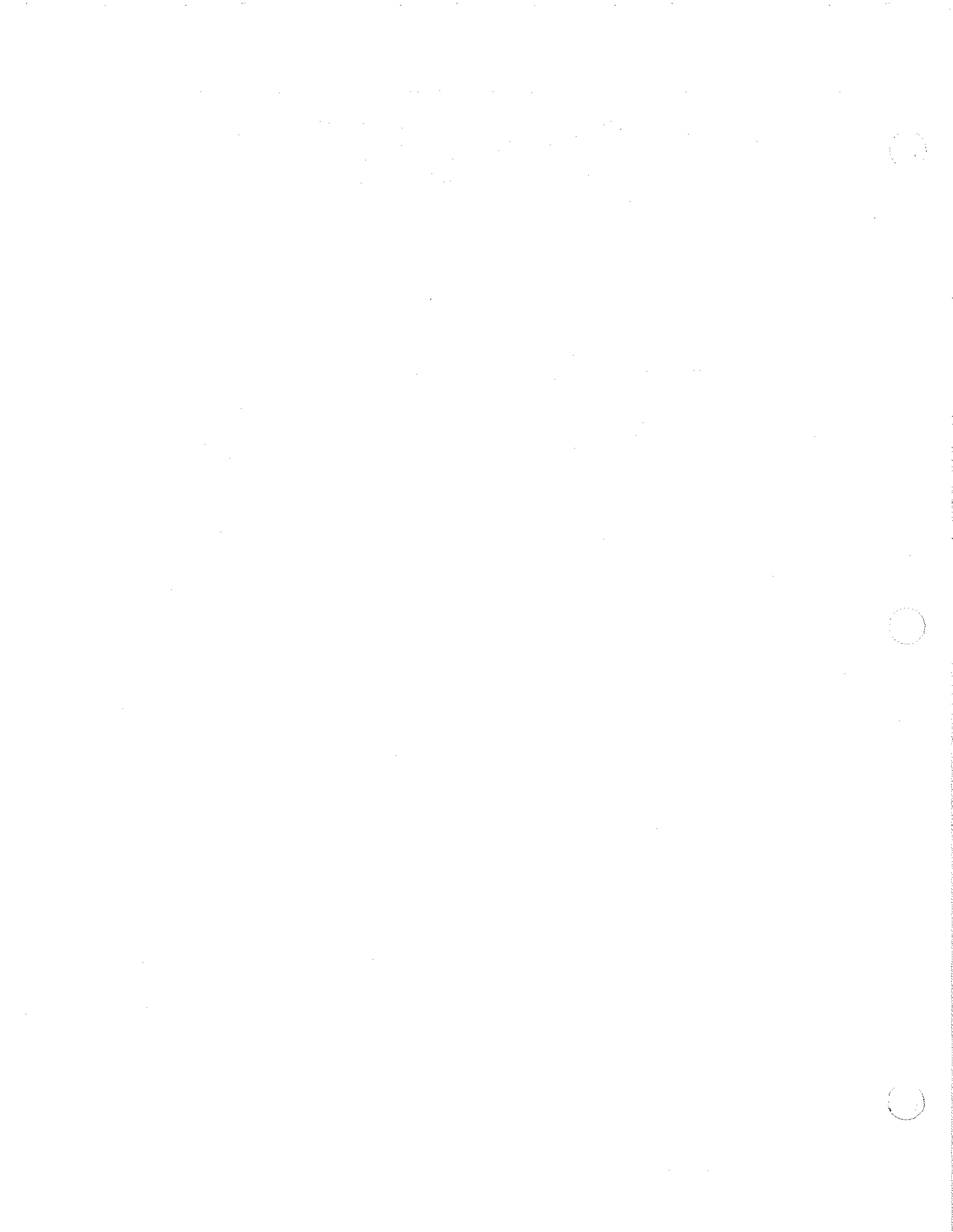
The HT50 is operational when all tests have been performed successfully.



---

## 6. 10,000 HOUR MAINTENANCE PROCEDURE

Introduction .....	6-1
Tools .....	6-1
Parts Required .....	6-2
Overhaul Procedure .....	6-2



## INTRODUCTION

The HT50 ventilator requires technical maintenance every 10,000 hours or every three years, whichever occurs first.

**NOTE:** When 10,000 hours has elapsed, the HT50's Message Display Window will indicate "Service Needed" after the next power up.

**WARNING** After every technical maintenance, the Calibration and Operational Verification Procedure (Section 5) must be performed successfully before returning the HT50 to patient use.

**WARNING** Lethal voltages are present inside the ventilator. To prevent electrical shock, use extreme caution when working on the ventilator with front bottom cover panel opened.

When preparing to return "core exchange" parts (i.e. pump assembly), clearly identify them as such, and return them to NEWPORT with the following information:

- Date
- Ventilator serial number
- Contact name
- Organization name
- Organization address
- Reason for replacement
- Copy of completed OVP test record (Section 5)

Follow the shipping instructions detailed in Section 10 of this manual.

Replacement parts and assemblies which are returned to NEWPORT following proper procedures will be credited according to the "core charge" list. Contact NEWPORT Tech. Service for more information. Tel. 949.642.3910, ext. 500 or fax 949.548.3091.

For a complete list of "core exchange" items, see Appendix A, Parts List.

## TOOLS REQUIRED

#10 Torx screwdriver

Philips head screwdriver

7/64" Allen wrench

Torque screwdriver (for #10 torx & 7/64" allen)

**NOTE:** All allen head #10 screws are tightened to 12" lbs. torque.

# 10,000 HOUR MAINTENANCE PROCEDURE

---

## PARTS REQUIRED

1 ea.	V11-21000-60X	Exchange Pump Assembly
1 ea.	G19-00001-29	Internal Battery
1 ea.	HT460300	Air Intake Filters, 5 pk
1 ea.	HT6004701	Proximal Inline Filters, 5 pk

**NOTE:** The four items listed above are not offered as a kit, since some of these items (i.e. filters) should be stock items.

**NOTE:** If ordering an exchange pump assembly (p/n V11-21000-60X), a "core charge" will be issued against the ordered part. Please follow the instructions regarding "core exchange" in this Section, under Introduction.

## OVERHAUL PROCEDURE

### Inspection of the Ventilator

**NOTE:** While performing the maintenance, visually inspect all parts of the ventilator for wear or damage. Replace parts as necessary.

1. Power Cord
  - Inspect the power cord to ensure that there are no exposed wires. If damage is noted, replace power cord.
  - Inspect the ends of the power cord to ensure that the plugs do not show excessive wear.
2. Front Panel Overlay
  - Inspect the front panel overlay to ensure that there are no raised edges or cuts in the overlay that would allow moisture underneath the panel.
3. Humidifier Assembly (HT50-H model only)
  - Inspect the humidifier chamber for any stress fractures or cracks. Replace as necessary.
  - Inspect the heater plate for corrosion and clean as necessary.

### Replacement of Internal Battery

**NOTE:** The internal battery should be replaced at least once every three years, and is typically replaced during the 10,000 hr. maintenance. The battery should also be replaced if the customer notices reduced battery running time after a full charge.

Refer to Figure 9-1 (Internal View).

1. Remove the 6 ea. #10 torx screws securing the lower case (1) of the HT50 to the ventilator housing. DO NOT remove the four rubber feet.
2. Remove the lower case cover, carefully avoiding tension on the battery lead wires.
3. Disconnect the battery connector (3), by pressing the release tab on the connector.
4. Remove the 10 ea. #10 torx screws (6) securing the battery case (2) to the lower case cover. Remove the battery case.
5. Remove the battery wiring harness from the old battery and reinstall it on the new battery. Make certain that red wire terminal connector is attached to the positive (+) terminal and the black to the negative (-) terminal.

**Caution** The HT50 ventilator contains an internal sealed lead acid battery. When replacing this battery, be certain to recycle or dispose of it properly.

6. Note the installation date on the new battery.
7. Reinstall the internal battery by reversing step 4.

### Replacement of Pump Assembly

**NOTE:** The pump Assembly is scheduled to be replaced every 10,000 hrs. The pump should also be replaced if exhibiting any unusual noise or if it appears to be malfunctioning in any way.

8. Disconnect the two pump Assembly wiring harnesses (36) and (37) from the Main board by pressing the release tab on each connector.
9. Slide the Muffler Assembly (13) from the pump inlet by pushing and twisting it back and forth until it disengages from the silicone cuff on the pump. After disconnecting the Muffler Assembly from the pump inlet, rotate it toward the rear panel of the ventilator housing so that it creates minimal interference with the removal of the pump.
10. Remove the 4 ea #10 torx screws (28) securing the pump to the ventilator housing. These screws are located externally near the Main Flow Outlet Manifold of the ventilator.

**NOTE:** The next four steps allow for easier removal of the solenoid's (84) silicone tubes.

## 10,000 HOUR MAINTENANCE PROCEDURE

---

11. Remove the 6 pin power supply wiring harness connector from the Main PCB by pressing the release tab on the connector.
12. Remove the 2 ea. silicone tubes (38 & 39) from the Outlet Assembly connectors, marking them to avoid improper reattachment.
13. Remove the smaller silicone tube located directly above the two connectors from step 12.
14. Remove the silicone tube (38) connected between the tee and solenoid (84).
15. Gently slide the pump Assembly out of the ventilator housing.

**NOTE:** Before installing the new pump Assembly, make certain the diaphragm in the new pump is clean and is properly seated in the pump housing counterbore.

16. Before installing the new pump Assembly, remove the two tubes still attached to the old solenoid (84). Make certain to attach each tube to the identical connector on the new solenoid.
17. Install replacement pump Assembly by reversing steps 8 through 14.

**NOTE:** When sliding the Muffler Assembly (13) back into place, open the air intake filter cover (8) and make certain that the end of the muffler is flush with the ventilator housing. This will minimize the possibility of a leak around either Muffler connection.

18. Finish assembling the ventilator by reversing steps 1 through 3.

### Changing the Filters

**WARNING** Do not reverse the filters. Always replace them if dirty or contaminated.

1. Remove the Air Intake Filter Cover (8) by loosening the 3 ea. thumbscrews.
2. Remove and discard the old filter. Install the new filter (p/n HT460300), making certain that the filter media is laying flat within the counterbore of the cover.
3. Reinstall the Air Intake Filter Cover, making certain that the filter media remains securely in place.

4. Remove and discard the old inline proximal filter and tubing. Replace with new filter/tubing assembly (p/n HT6004701).

### **Cleaning the HT50 Ventilator**

Wipe the surfaces of the ventilator with a damp cloth containing a mild medical detergent.

**Caution** Do not use agents containing acetone, toluene, halogenated hydrocarbons, or strong alkalines on the face panel or ventilator housing.

**NOTE:** Alcohol may be used to sanitize the face panel and ventilator housing. Care should be taken not to allow liquids to penetrate the ventilator.

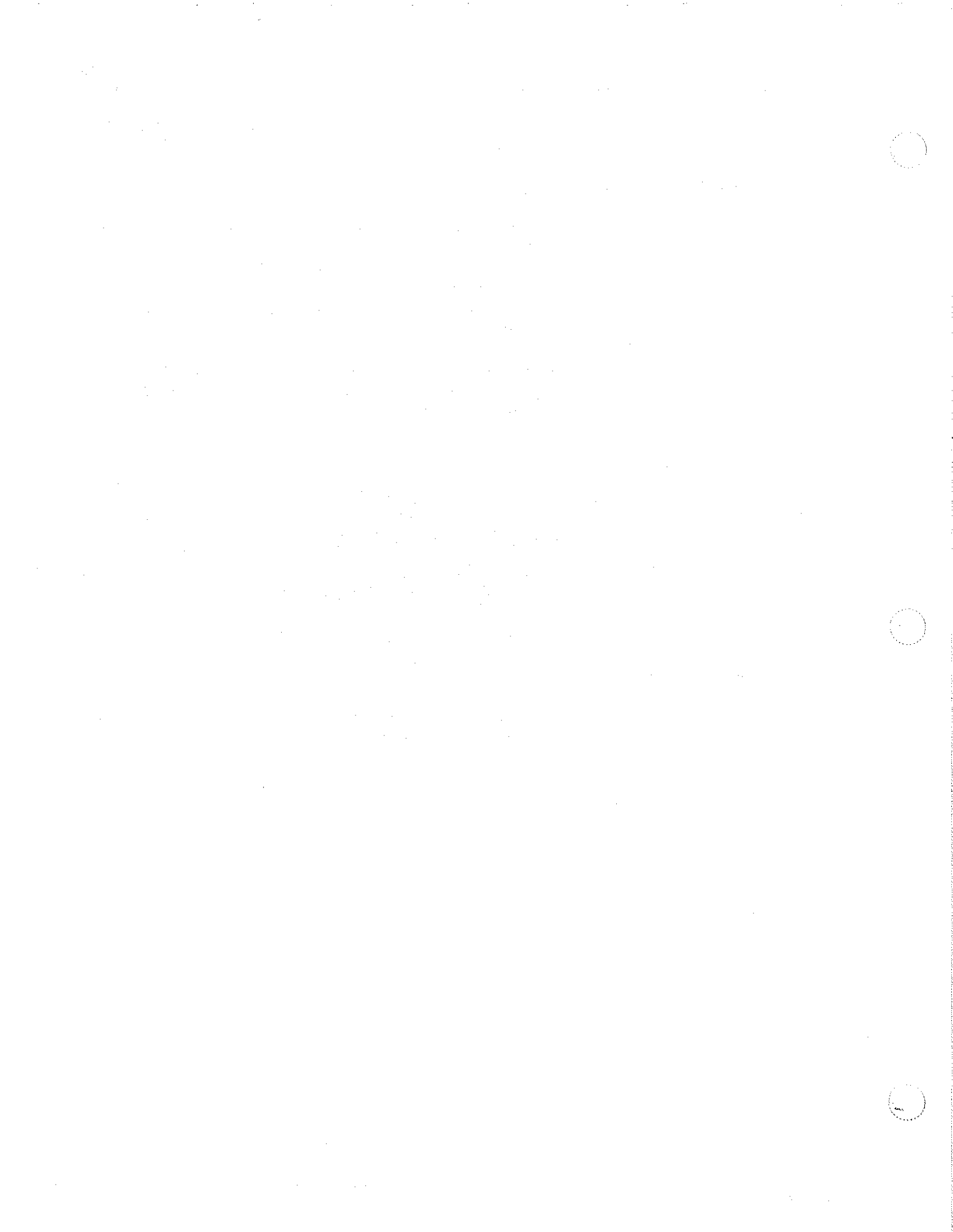
### **Burn-in Test**

**WARNING** The ventilator is a critical life support device. Upon replacement of any critical assembly, it is important to complete a 24 hour burn-in to assure proper operation.

1. To complete the burn-in test, set the ventilator to the Standard Test Settings detailed in Section 5.
2. Let the ventilator operate for 24 hours.

### **Operational Verification Procedure**

Upon completion of the Burn-in test, perform all calibrations and OVP as detailed in Section 5.



---

# 7. TROUBLESHOOTING GUIDE

Introduction .....	7-1
Mechanical and Pneumatic Troubleshooting .....	7-2
Electronic Troubleshooting .....	7-5



**INTRODUCTION**

This troubleshooting guide is intended to assist a NEWPORT authorized service technician to troubleshoot and repair the HT50 ventilator.

The troubleshooting instructions are separated into two sections:

- Mechanical and Pneumatic
- Electronic.

**NOTE:** Refer to the Troubleshooting section of the Operating manual for more clinically oriented ventilator problems.

If you need assistance to troubleshoot or repair the ventilator, please contact the NEWPORT Technical Service Dept. See pg 1-7 for contact information.

**WARNING** Hazardous voltages are present inside the ventilator. Disconnect electrical power and oxygen sources before attempting any disassembly. Failure to do so could result in injury to service personnel or equipment.

# TROUBLESHOOTING

## MECHANICAL & PNEUMATIC TROUBLESHOOTING

PROBLEM	POTENTIAL CAUSE	SUGGESTED CORRECTIVE ACTION
Ventilator fails System Leak Test.	Pump is pulling in air from around the air inlet filter cover.	Make certain that the filter media is positioned within the counterbore of the cover and that the thumbscrews are tightened securely.
	Muffler Assembly is disconnected or leaking or is cracked.	Verify muffler Assembly is securely connected to both the pump inlet and the air intake. With the air intake filter cover removed, verify that the end of the muffler is flush with the ventilator housing. Visually inspect muffler assembly for cracks. Replace if cracked.
Ventilator fails Pressure Transducer and/or Pressure Relief Valve calibration.	Leak in the patient circuit Assembly	Make certain that the humidifier chamber is bypassed for these tests. The breathing circuit tubing should be directly connected to the GAS OUTPUT connector. Also, verify that the exhalation valve is not leaky at the highest pressure level. If so, replace exhalation valve.  <b>Note:</b> When performing the Pressure Relief Valve calibration, if an alternate Newport approved exhalation valve is used (such as the Newport amber exh. valve or disposable exh. valve) it may begin to leak at lower maximal pressures than the permanent blue exhalation valve. This is a limitation of the exhalation valve and the HT50 driving pressure. The ventilator is performing appropriately.
Low proximal pressure (Paw), but normal flows.	Faulty patient breathing circuit.	Check breathing circuit for leaks and/or proper connections.
	Humidifier chamber leaking.	Bypass chamber and retest. If problem is solved, loosen, reposition, and tighten chamber cover. Retest.
	Faulty exhalation valve.	Recalibrate exhalation valve (Section 5). If problem persists, replace valve.
	Pressure relief valve or emergency intake valve leaking.	Check both valves for proper sealing. Perform the Pressure Relief Valve calibration (Section 5).

PROBLEM	POTENTIAL CAUSE	SUGGESTED CORRECTIVE ACTION
Low proximal pressure (Paw) and low flows at Gas Output connector.	Pressure relief valve or emergency intake valve leaking.	Check both valves for proper sealing. Perform the Pressure Relief Valve calibration (Section 5).
	Air inlet filter clogged.	Replace air inlet filter.
	Internal leak in the pump (i.e. ruptured diaphragm, leaking one way valve).	Check diaphragm. Tighten 4 screws connecting the pump to the left side. If problem persists, replace the Pump Assembly.
"Motor Fault" Device Alert alarm, or no Device Alert alarm, but proximal pressure is rising slower than expected.	Blocked air inlet.	Replace air inlet filter.
	High FIO <sub>2</sub> selected on Air/O <sub>2</sub> mixer, and oxygen supply is depleted.	Verify sufficient oxygen supply. Replace as needed. If problem continues, remove Air/O <sub>2</sub> mixer. If problem is resolved, replace Air/O <sub>2</sub> mixer. If problem persists, replace Pump Assembly.
Unstable baseline.	Breathing circuit leak.	Check breathing circuit for leaks and/or proper connections. Make certain "star" tubing is not a direct connection to any HT50 connectors.
	Exhalation valve is not calibrated.	Calibrate the exhalation valve (Section 5). If the valve fails calibration, replace. If valve passes but problem persists, try a new valve.
	Internal solenoid is not functioning properly.	Verify that both ends of the tubings connected to the solenoid are secure. Verify that the tubing from the Gas Output connector and the internal pressure transducers are secure. Calibrate the exhalation valve. Retest for baseline stability. If the problem persists, replace the Pump Assembly  (Note: Solenoid is part of the pump.)

# TROUBLESHOOTING

PROBLEM	POTENTIAL CAUSE	SUGGESTED CORRECTIVE ACTION
Baseline shows PEEP w/ PEEP set to zero.	Water inside exhalation valve diaphragm.	Disconnect the exhalation drive line tubing, then turn exhalation valve upside down to allow any water that is trapped to exit. If problem still persists, replace exhalation valve.
	Kinked or obstructed exhalation or proximal pressure tubing.	Check and correct as needed. Replace inline proximal filter.
	Paw meter needs calibration.	Calibrate. (See Section 5.)
	Contaminated solenoid.	Replace Pump Assembly. <b>(Note: Solenoid is part of the pump)</b>
Proximal pressure returns to baseline very slowly.	Kinked or obstructed proximal pressure line.	Check and correct as needed. Replace inline proximal filter.
	HME causing resistance to exhalation.	Remove/change HME.
Pump is emitting "squeaking" noise.	Contamination on the piston rods.	Using alcohol and a non-residue type material (i.e. gauze), gently clean piston rods. If problem is not corrected, replace Pump Assembly
Pump is emitting "ticking" noise.	Loose bearing.	Replace Pump Assembly.
Pump loudness seems to be much greater than normal.	Large leak in breathing circuit.	Resolve leak.
	Internal muffler is disconnected.	Open lower case and assure that the muffler is connected securely at both ends with the appropriate silicone cuff. Perform System Leak Test in Section 5.
	Problem with Pump Assembly	Replace Pump Assembly.
Vibration noise (i.e. bezel, humid. Retaining arm, etc.).	Improper Assembly	Secure all external screws to 12" lbs. Tighten all thumbscrews or knobs securely.
Front panel cover is loose, rattling, or not shutting properly.	Physical damage to the front panel cover.	Remove and replace front panel cover. Verify that the plastic sleeve bearings are present on both ends of the cover.

## ELECTRONIC TROUBLESHOOTING

PROBLEM	POTENTIAL CAUSE	SUGGESTED CORRECTIVE ACTION
Ventilator does not operate on internal battery.	Battery fully discharged.	Connect HT50 to A.C. power, allowing battery to charge for several hours, then check charge level. If the battery does not seem to be charging, disconnect the battery wiring harness from the Main PCB. Check the voltage across the battery wiring harness connector. If voltage is > 0 volts but < 8 volts, replace battery.
	Battery fuse defective.	Check the voltage across the battery wiring harness connector. If voltage is 0 volts, replace fuse.
	Defective Main PCB.	Replace Main PCB.
Ventilator is unable to switch from DC power back to AC power.	Defective Power Supply PCB.	If ventilator functions normally on internal battery, replace Power Supply PCB.
	Defective Main PCB.	Replace Main PCB.
10 V SHUTDOWN Device Alert Alarm	Defective Main PCB.	Replace Main PCB.
OCCL. SHUTDOWN Device Alert Alarm	Prox line kinked or prox filter occluded.	Replace prox line filter and check prox line for obstruction.
	Defective Solenoid.	Replace Pump Assembly.
	Defective Main PCB.	Replace Main PCB.
SYSTEM ERROR Device Alert Alarm	EPROM not seated firmly.	Make certain EPROM is firmly in the socket.
	Battery completely empty or disconnected during ventilation.	Check battery connectors and fuse. Charge battery.
	Defective Main PCB.	Replace Main PCB.
MOTOR FAULT Device Alert Alarm	Pump is unable to get sufficient air intake.	Check air intake filter. Replace as needed. If using Air/O <sub>2</sub> mixer, verify sufficient tank supply pressure.
	Defective Pump Assembly	Replace Pump Assembly.
	Defective Main PCB.	Replace Main PCB.

# TROUBLESHOOTING

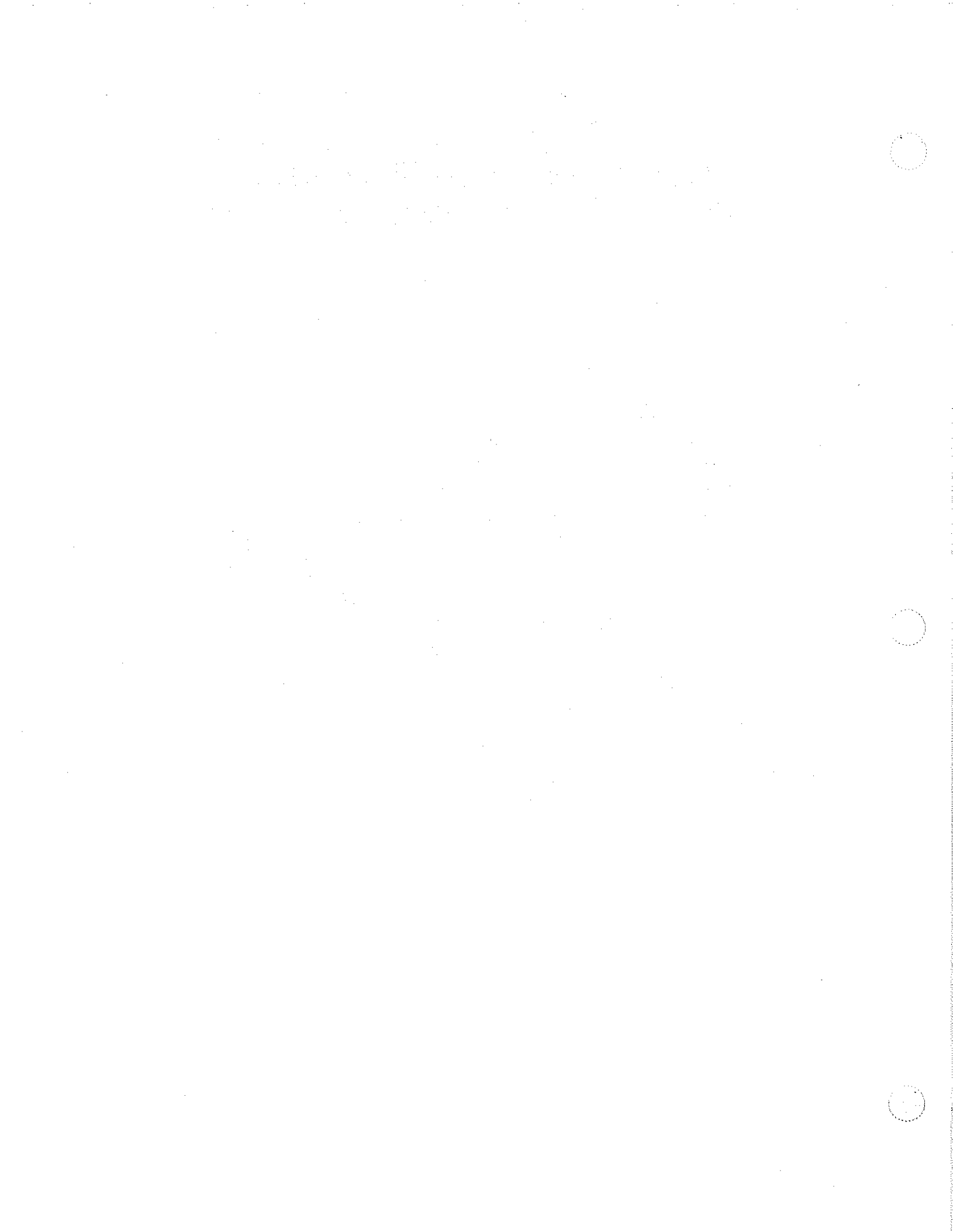
---

<b>PROBLEM</b>	<b>POTENTIAL CAUSE</b>	<b>SUGGESTED CORRECTIVE ACTION</b>
Meter does not calibrate.	Meter is holding static charge.	Using a cloth with alcohol, gently wipe the surface area of the front panel that covers the meter. Recalibrate.
	Defective meter.	Replace panel PCB.
Humidifier Fail alarm (HT50-H)	Loss of A.C. power.	Restart humidifier when A.C. power is available.
	Improper installation of the chamber or temperature probe.	See Operating manual for installation instructions.
	Defective temperature probe.	Replace temp. probe.
	Humidifier heater Assembly is defective.	With humidifier chamber firmly secured, disconnect the square four pin connector on the Main PCB. Using an ohmmeter, measure the resistance between the pins of the two blue wires. Resistance should be < 3000 ohms, but > 0. Next, measure the resistance between the pins of the two black wires. Resistance should be approx. 4 ohms. If either of these measurements are incorrect, replace the heater Assembly
High Prox Temp alarm (HT50-H)	Defective temperature probe.	Replace temp. probe.
	Defective connection to Main PCB.	Using an ohmmeter, verify continuity from probe connector to Main PCB.
	Defective Main PCB.	Replace Main PCB.
LED(s) and or control panel button(s) do not function.	Ribbon cable not securely fastened.	Verify that both ends of the ribbon cable are securely fastened.
	Defective Panel PCB.	Replace Panel PCB.

---

## **8. ELECTRONIC & PNEUMATIC COMPONENT REMOVAL & REPLACEMENT PROCEDURES**

Introduction .....	8-1
Tools Required .....	8-1
Disassembly (Lower Case) .....	8-2
Reassembly (Lower Case) .....	8-2
Internal Battery Assembly Replacement .....	8-2
Pump Assembly Replacement .....	8-3
Outlet Assembly Replacement .....	8-4
Humidifier Heater Assembly Replacement .....	8-4
Front Panel Board Replacement .....	8-5
Front Panel Assembly Replacement .....	8-6
Main Board Assembly Replacement .....	8-6
Power Supply Replacement .....	8-7



**INTRODUCTION**

The following assemblies are replaceable during service, if they are worn, damaged or suspected to be performing improperly.

- Internal battery assembly
- Pump assembly\*
- Outlet assembly
- Humidifier assembly
- Front panel PCB assembly\*
- Main board assembly\*
- Power supply assembly\*

The parts listed above with an asterisk (\*) are to be returned to NEWPORT for "core exchange." Worn or damaged parts and assemblies are exchanged with new or rebuilt parts, with prior customer approval.

Parts that are removed from the ventilator for core exchange are to be placed in their replacement box with the following information:

- ✓ Date
- ✓ Ventilator serial number
- ✓ Contact name
- ✓ Organization name
- ✓ Organization address
- ✓ Reason for the replacement: performance observations or user complaint that initiated the replacement
- ✓ Copy of the completed OVP test record

Follow the shipping instructions detailed in Section 10.

Replacement parts and assemblies which are returned to the manufacturer in the proper manner will be credited according to the core charge list. Contact Newport Service Department for more information. 1.949.642.3910, ext. 500 fax: 1.949.548.3091

**Warning** Hazardous voltages are present inside the ventilator. Disconnect electrical power and oxygen sources before attempting any disassembly. Failure to do so could result in injury to service personnel or equipment.

**TOOLS REQUIRED**

#10 torx screwdriver

Phillips head screwdriver

7/64" Allen wrench

Torque screwdriver (for #10 torx & 7/16" Allen)

**NOTE:** All allen head and size 10 torx screws are tightened to 12 in-lb torque.

# ELECTRONIC & PNEUMATIC COMPONENT REMOVAL & REPLACEMENT PROCEDURES

---

## DISASSEMBLY (Lower Case)

Refer to drawing Figure 9-1, Internal View.

1. Remove the 6 ea. #10 torx screws securing the lower case (1) of the HT50 to the ventilator housing. DO NOT remove the four rubber feet.
2. Remove the cover carefully avoiding tension on the battery lead wires.
3. Disconnect the battery connector (3), by pressing the release tab on the connector.

## RE-ASSEMBLY (Lower Case)

1. Reverse steps 1-3 in Disassembly. Replace all screws and connectors properly.

**NOTE:** When closing the lower case cover (1) make sure all wires are tucked in so they are away from the battery cavity and the lower cover mating surface to ensure that wires do not get pinched between clamped surfaces.

## INTERNAL BATTERY ASSEMBLY REPLACEMENT

### Replacement

Refer to drawing Figure 9-1, Internal View.

1. Follow steps 1-3 in Disassembly (Lower Case) section above.
2. Remove the 10 ea. #10 torx screws (6) securing the battery case (2) to the lower case cover. Remove the battery case.
3. Remove the battery wiring harness from the old battery and reinstall it on the new battery. Make certain that red wire terminal connector is attached to the positive (+) terminal and the black to the negative (-) terminal.

**Caution** The HT50 ventilator contains an internal sealed lead acid battery. When replacing this battery, be certain to recycle or dispose of it properly.

4. Note the installation date on the new battery.
5. Reinstall the internal battery and lower case by reversing steps 1 and 2.

## PUMP ASSEMBLY REPLACEMENT

Refer to Figure 9-1 (Internal View).

1. Follow steps 1-3 in the DISASSEMBLY (lower case) section.
2. Disconnect the two Pump Assembly wiring harnesses (36) and (37) from the Main board by pressing the release tab on each connector.
3. Slide the Muffler Assembly (13) from the pump inlet by pushing and twisting it back and forth until it disengages from the silicone cuff on the pump. After disconnecting the Muffler Assembly from the pump inlet, rotate it toward the rear panel of the ventilator housing so that it creates minimal interference with the removal of the pump.
4. Remove the 4 ea #10 torx screws (28) securing the pump to the ventilator housing. These screws are located externally near the Gas Output Assembly of the ventilator.

**NOTE:** The next four steps allow for easier removal of the solenoid's (84) silicone tubes.

5. Remove the 6 pin power supply wiring harness connector from the Main PCB by pressing the release tab on the connector.
6. Remove the 2 ea. silicone tubes (38 & 39) from the Outlet Assembly connectors, marking them to avoid improper reattachment.
7. Remove the smaller silicone tube located directly above the two connectors from step 12.
8. Remove the silicone tube (38) connected between the tee and solenoid (84).
9. Gently slide the Pump Assembly out of the ventilator housing.

**NOTE:** Before installing the new Pump Assembly, make certain the diaphragm in the new pump is clean and is properly seated in the pump housing counterbore.

10. Before installing the new Pump Assembly, remove the two tubes still attached to the old solenoid (84). Make certain to attach each tube to the identical connector on the new solenoid.
11. Install replacement Pump Assembly by reversing steps 2 through 8.

## **ELECTRONIC & PNEUMATIC COMPONENT REMOVAL & REPLACEMENT PROCEDURES**

---

**NOTE:** When sliding the Muffler Assembly (13) back into place, open the air intake filter cover (8) and make certain that the end of the muffler is flush with the ventilator housing. This will minimize the possibility of a leak around either Muffler connection.

12. Finish assembling the ventilator by reversing steps 1 through 3.

### **OUTLET ASSEMBLY REPLACEMENT**

Refer to drawing Figure 9-1, Internal View.

The Outlet Assembly should be replaced if:

- Damage to either of the 3 connectors is visible.
  - Emergency Intake Valve is leaking (rear of outlet block).
  - Pressure Relief Valve is leaking at low pressure (bottom of outlet block).
1. Follow steps 1 through 9 of the PUMP ASSEMBLY REPLACEMENT section.
  2. Remove the one remaining silicone tube (40) attached to the Outlet Assembly, marking it to avoid improper reattachment.
  3. Remove the 2 ea. #10 torx screws (31) which secure the Outlet Assembly to the ventilator housing.
  4. Install the new Outlet Assembly, making certain the o-ring seal and the humidifier's heater wires (HT50-H only) are within the counterbore of the Outlet Assembly so that neither are pinched by the Outlet Assembly when securing it to the ventilator housing.
  5. Reverse steps 1 through 3 to reassemble.

### **HUMIDIFIER HEATER ASSEMBLY REPLACEMENT (HT50-H ONLY)**

Refer to drawing Figure 9-1, Internal View.

The Humidifier Heater Assembly should be replaced if:

- when the humidifier chamber is securely fastened, the safety thermostat activates, turning the heater off.
  - the assembly is cracked or physically damaged.
  - the heater plate does not rise and activate the safety switch beneath it when the humidifier chamber is removed.
1. Follow steps 1 through 3 in the previous Outlet Assembly Replacement section.

2. Remove the 2 ea. #10 torx screws (27) that secure the Humidifier Heater Assembly to the ventilator housing.
3. Disconnect the humidifier heater's wiring assembly connector from the Main PCB by pressing the release tab on the connector. Pull the connector out through the hole in the ventilator housing to remove the old Assembly
4. Place the connector of the new Humidifier Heater Assembly through the hole in the ventilator housing.
5. Place the Outlet Assembly (30) over the heater assembly's wiring harness, making certain that it is not pinched and that the o-ring seal of the Outlet Assembly is properly in place.
6. Secure the Outlet Assembly to the ventilator housing with 2 ea. #10 torx screws (31).
7. Secure the Humidifier Heater Assembly to the ventilator housing with 2 ea. #10 torx screws (27).
8. Reattach the wiring harness connector to the Main PCB.
9. Reverse step 1 to reassemble.

## **FRONT PANEL BOARD REPLACEMENT**

Refer to drawing Figure 9-2, Final Assembly Front View.

The Front Panel PCB should be replaced if:

- any of the front panel buttons, displays, or alarms are malfunctioning.
  - the analog meter is malfunctioning.
1. Remove the 6 ea. 7/64" allen screws (49) from the Front Panel bezel. Gently separate the bezel from the main ventilator housing.
  2. Disconnect 2 ea. connectors (JP1 & JP2) from the Front Panel PCB.
  3. Place the Front Panel Assembly face down on a flat surface. Remove the 10 ea. Phillips head screws securing the Front Panel PCB to the front panel plate.
  4. Remove Front Panel PCB and place it inside an anti-static bag.
  5. To install the new Front Panel PCB, reverse steps 1 through 3.

# ELECTRONIC & PNEUMATIC COMPONENT REMOVAL & REPLACEMENT PROCEDURES

---

## FRONT PANEL ASSEMBLY REPLACEMENT

Refer to drawing Figure 9-2, Final Assembly Front View.

The Front Panel Assembly should be replaced if:

- any of the front panel buttons are not functional.
  - the panel overlay is visibly damaged.
1. Follow steps 1 through 4 in the FRONT PANEL BOARD REPLACEMENT section.
  2. Remove the 6 ea. #10 torx screws securing the front panel plate to the bezel. Gently separate the plate from the bezel.
  3. To install the new Front Panel Assembly, reverse steps 1 and 2.

## MAIN BOARD ASSEMBLY REPLACEMENT

Refer to drawing Figure 9-1, Internal View, Figure 9-3, Final Assembly Front View, and Figure 9-4, Main Board with Mounting Hardware.

**NOTE:** Any electronic malfunction that is not resolved with the replacement of the Front Panel PCB is usually resolved by replacing the Main PCB Assembly

1. Follow steps 1 through 3 of the DISASSEMBLY (Lower Case) section.
2. Remove the 6 ea. 7/64" allen screws (49) from the Front Panel bezel. Gently separate the bezel from the main ventilator housing.
3. Disconnect 2 ea. connectors (JP1 & JP2) from the Front Panel PCB.
4. Disconnect all electrical connectors from the Main PCB.
5. Remove the 4 ea. Philips head screws securing the RS232 connector (P1) and the two transistors (Q1 & Q9) to left hand side of the ventilator housing.
6. Remove the 3 ea. #10 torx screws (52 & 61) securing the Main PCB's mounting hardware to the ventilator housing.
7. Disconnect the 2 ea. silicone tubes (39 & 40) from the transducers mounted to the Main PCB, marking them to avoid incorrect reattachment.

8. Remove defective Main PCB. Transfer the mounting hardware as necessary to the new PCB.
9. Reverse steps 1 through 7 to install the new Main PCB and reassemble.

**NOTE:** Make certain that the insulator and the insulating bushing are properly placed when reattaching the transistors to the ventilator housing.

## **POWER SUPPLY BOARD REPLACEMENT**

Refer to drawing Figure 9-1, Internal View.

The Power Supply Board should be replaced if the ventilator is inoperable with either external A.C. or D.C. power.

1. Follow steps 1 through 3 of DISASSEMBLY (Lower Case) section.
2. Remove the Filter Cover Assembly (8).
3. Remove the 6 ea. #10 torx screws (5) securing the Power Supply PCB to the ventilator housing.

**NOTE:** These screws are located externally on the right hand side of the ventilator. The two longer screws are used to secure the black electrical socket inlet.

4. Disconnect the wiring harness from the Power Supply PCB by pressing the release tab on the connector.
5. Remove and replace the old PCB with the new assembly.
6. Reverse steps 1 through 4 to reassemble.



---

## 9. DIAGRAMS AND PARTS LIST

Figure 9-1, Internal View

Figure 9-2, Final Assembly, Front View HT50-H

Figure 9-3, Final Assembly, Front View HT50-T, HT50-H1

Figure 9-4, Main Board with Mounting Hardware

Figure 9-5, Main Board Tubing Connection, Left Side

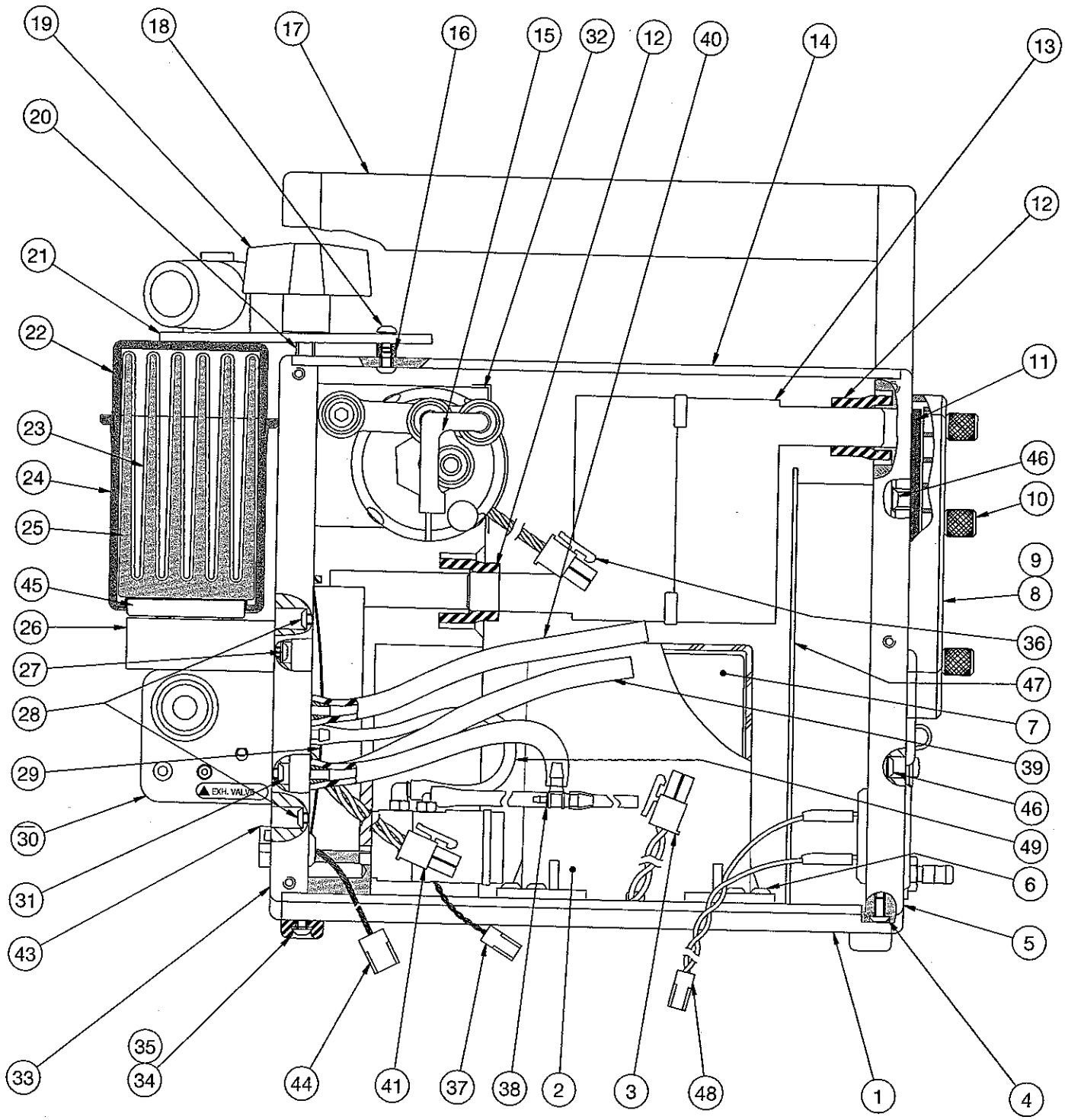
Figure 9-6, Right Side Case

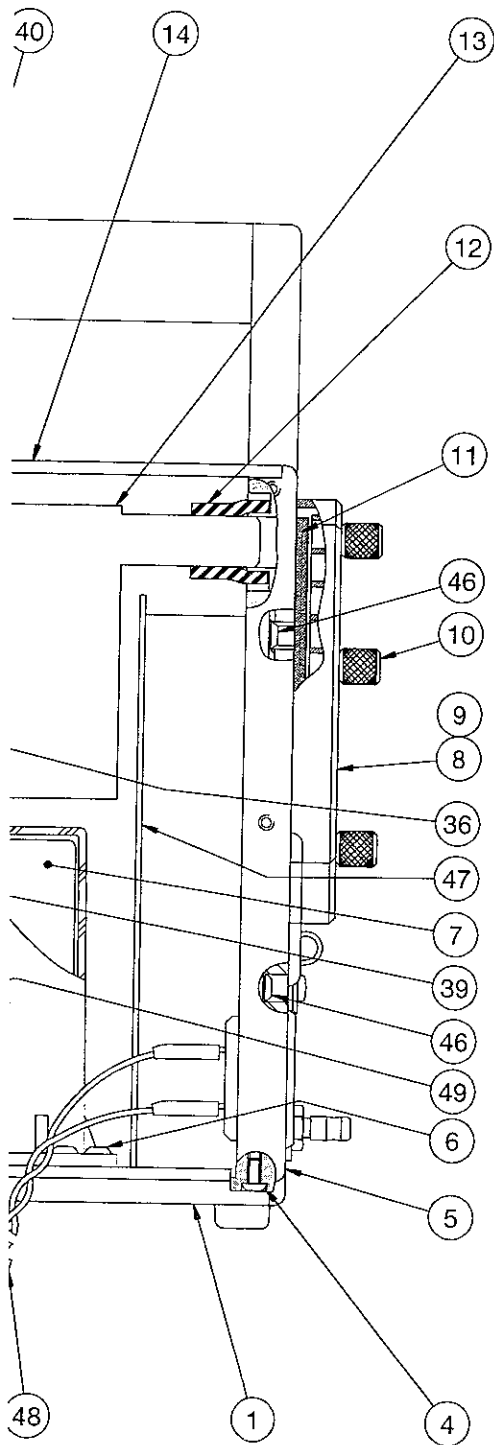
Figure 9-7, Front Panel, Side View

Figure 9-8, Pneumatic Schematic

Figure 9-9, Electrical System Overview

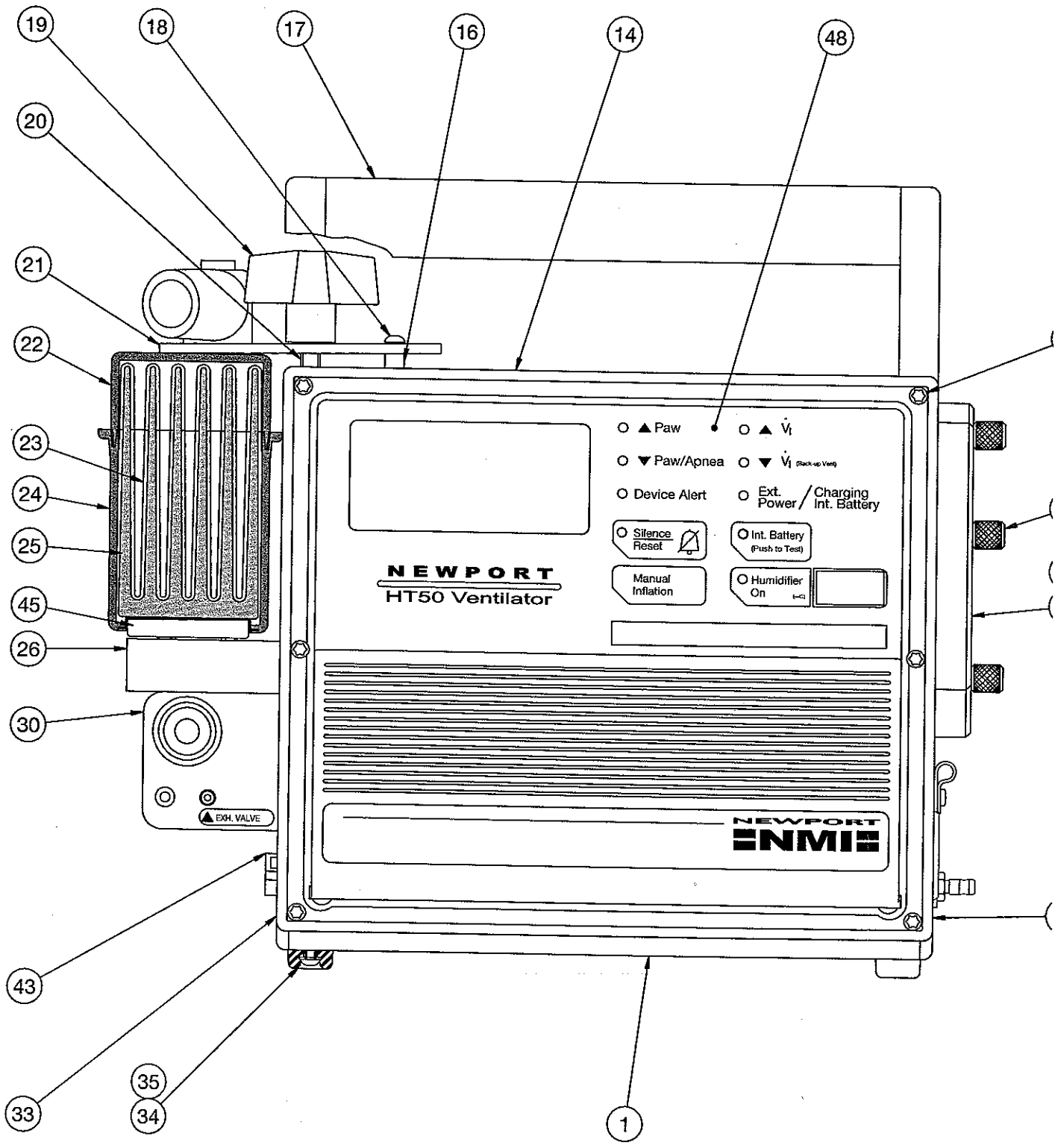
Drawing Reference List





49	V11-28100-06	1	SILICONE TUBE 2x4 (OF PART 3)	○
48	G29-00012-29	1	CONNECTOR 2 PINS 6471 CIDEV (OF ALARM ASSY.)	
47	V11-31000-65	1	POWER SUPPLY ASSY.	
46	G23-00001-23	6	TORX SCREW HD. 6-32 UNC x 1/4" LG.	
45	V12-12100-03	1	HEAT ELEMENT HOUSING	
44	G29-00013-29	1	CONNECTOR 3 PINS 6471 CIDEV	
43	G29-00031-29	1	T. PROBE CONNECTOR (FEMALE)	
41	G29-00004-29	1	MINI-FIT JR. CONNECTOR 4 PINS	
40	V11-28000-06	1	SILICONE TUBE 3 x 7 160mm	
39	V11-28000-06	1	SILICONE TUBE 3 x 7 160mm	
38	V11-26000-60	1	SILICONE TUBE ASSY.	
37	G29-00012-29	1	CONNECTOR 2 PINS 6471 CIDEV (OF SOLENOID ASSY.)	
36	G29-00008-29	1	MINI-FIT JR. CONNECTOR 8 PINS	
35	G23-00001-23	4	TORX SCREW HD. 6-32 UNC x 1/4" LG.	
34	G01-00001-67	4	FOOT	
33	V11-23100-03	1	CASE SIDE PLATE LEFT	
32	V11-21000-60	1	MANIFOLD ASSY.	
31	G23-00001-23	2	TORX SCREW HD. 6-32 UNC x 1/4" LG.	
30	V11-24000-63	1	OUTLET FITTING ASSY.	
29	V11-21700-06	1	MANIFOLD DIAPHRAGM	
28	G23-00001-23	4	TORX SCREW HD. 6-32 UNC x 1/4" LG.	
27	G23-00006-23	2	TORX K35 x 10 FOR PLASTIC	
26	V12-10000-60	1	HEATER ASSY.	
25	V12-33000-03	1	HEAT SINK	
24	V12-31000-68	1	HUMIDIFIER BOTTLE-LOWER ASSY.	
23	V12-34000-20	1	ABSORBENT PAPER	
22	V12-32000-18	1	HUMIDIFIER BOTTLE-UPPER	
21	V12-21000-03	1	HUMIDIFIER BRACKET	
20	G23-00021-23	1	ST. ST. SOCKET CAP SCREW 1/4"	
19	V12-22000-03	1	BAR KNOB	
18	G23-00001-23	2	TORX SCREW HD. 6-32 UNC x 1/4" LG.	
17	V11-22000-67	1	HANDLE ASSY.	
16	V12-40000-03	1	HUMIDIFIER STANDOFF	
15	V11-21100-83	1	CRANK MECHANISM LEFT ASSY.	
14	V11-41000-03	1	UPPER CASE COVER	
13	V11-33000-67	1	MUFFLER ASSY.	
12	V11-32000-06	2	SILICONE TUBE 1/2"x3/4" 18mm	
11	V11-35300-20	1	AIR INLET FILTER	
10	V11-35100-03	3	FILTER THUMB SCREW	
9	V11-36000-26	1	O-RING 50 DUROMETER SILICONE	
8	V11-35200-07	1	FILTER COVER	
7	G19-00001-29	1	BATTERY	
6	G23-00001-23	10	TORX SCREW HD. 6-32 UNC x 1/4" LG.	
5	V11-38100-03	1	CASE SIDE PLATE RIGHT	
4	G23-00001-23	6	TORX SCREW HD. 6-32 UNC x 1/4" LG.	
3	G29-00002-29	1	Mini-Fit Jr. CONNECTION 2 PINS	
2	V11-14000-07	1	BATTERY CASE COVER	
1	V11-12100-03	1	LOWER CASE COVER	
No.	PART NUMBER	QTY.	DESCRIPTION AND REFERENCE DESIGNATION	

**Figure 9-1  
Internal View**



19

18

17

16

14

48

20

21

22

23

24

25

45

26

30


43

33

35

34

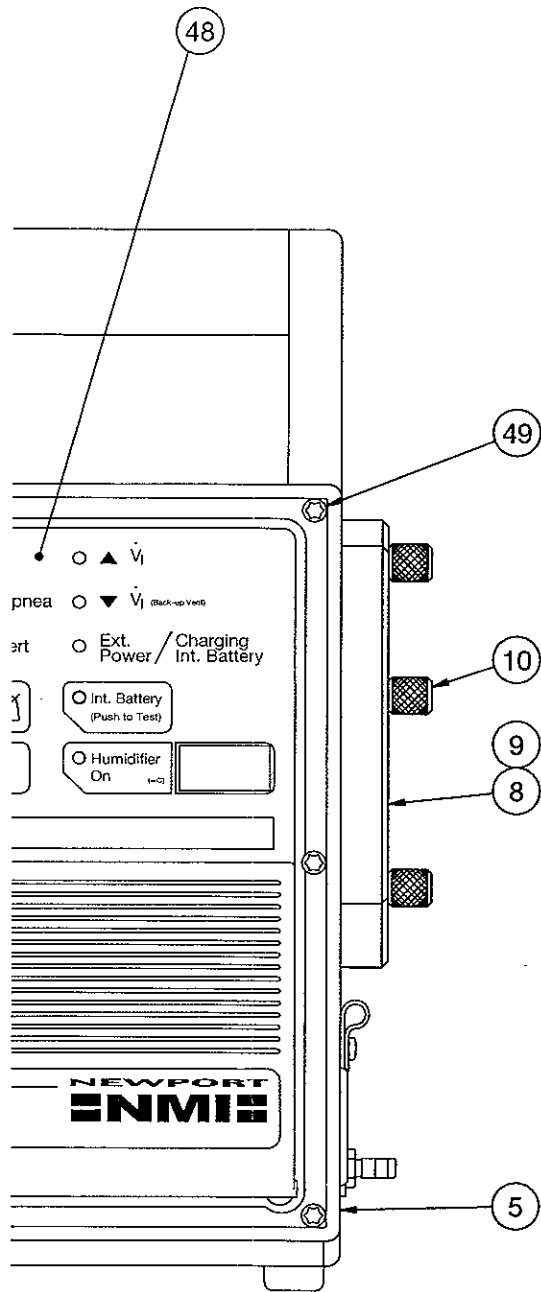
1

▲ Paw       ▲  $\dot{V}_T$   
 ▼ Paw/Apnea       ▼  $\dot{V}_T$  (Back-up Vent)  
 Device Alert       Ext. Power / Charging Int. Battery  
 Silence Reset        Int. Battery (Push to Test)  
     

**NEWPORT**  
HT50 Ventilator

**NEWPORT**  
**ENMIE**

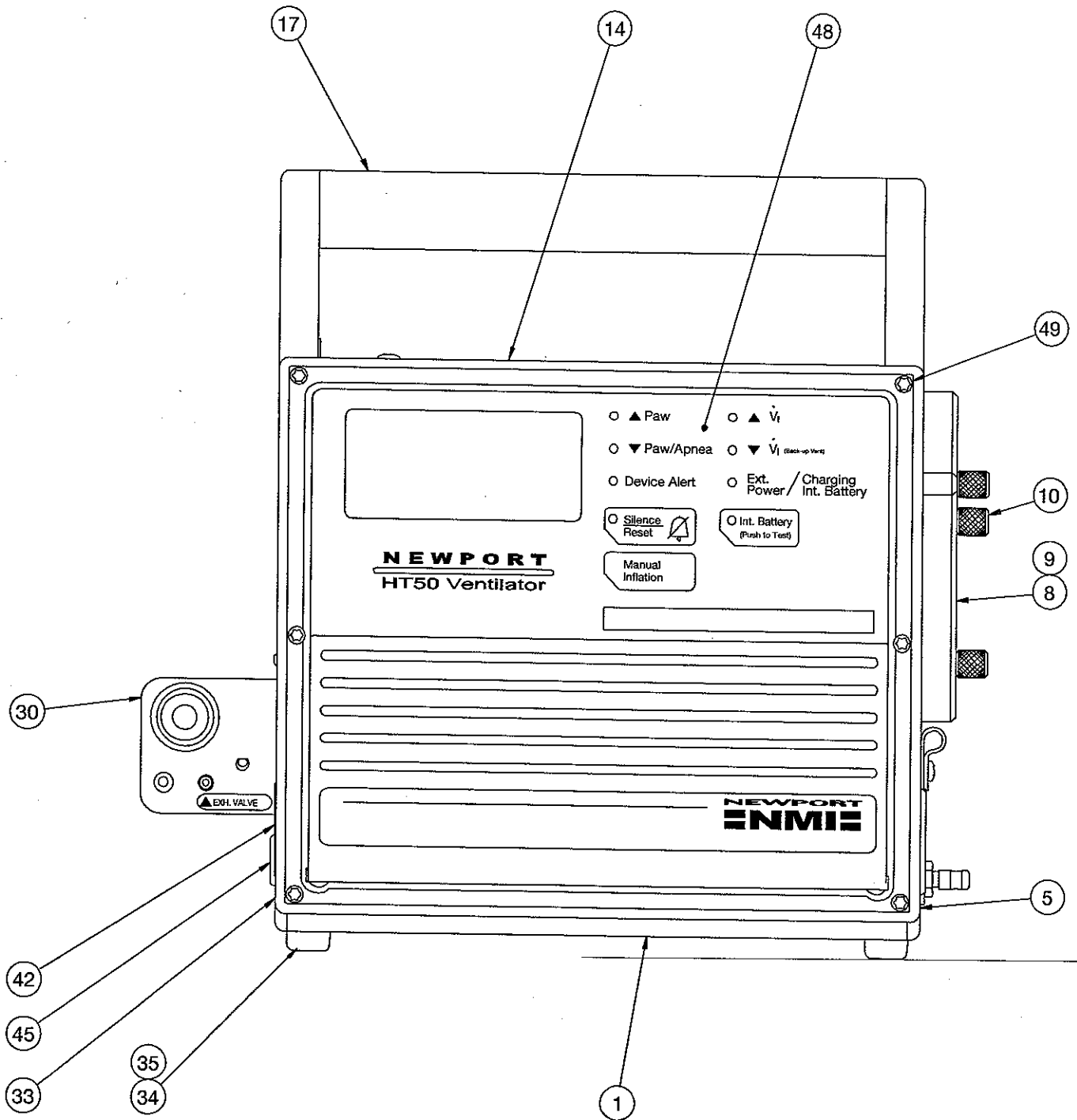
▲ EXH. VALVE



49	G23-00031-23	6	SOCKET HEAD CAP SCREW 6-32 x 1/2"
48	V11-70000-60	1	CONTROL PANEL ASSY.
45	V12-12100-03	1	HEAT ELEMENT HOUSING
43	G23-00031-29	1	T. PROBE CONNECTOR (FEMALE)
35	G23-00001-29	4	TORX SCREW HD. 6-32 UNC x 1/4" LG.
34	G01-00001-67	4	FOOT
33	V11-23100-03	1	CASE SIDE PLATE LEFT
30	V11-24000-63	1	OUTLET FITTING ASSY.
26	V12-10000-60	1	HEATER ASSY.
25	V12-33000-03	1	HEAT SINK
24	V12-31000-18	1	HUMIDIFIER BOTTLE-LOWER ASSY.
23	V12-34000-20	1	ABSORBENT PAPER
22	V12-32000-18	1	HUMIDIFIER BOTTLE-UPPER
21	V12-21000-03	1	HUMIDIFIER BRACKET
20	G23-00021-23	1	ST. ST. SOCKET CAP SCREW 1/4"x1 1/4"
19	V12-22000-03	1	BAR KNOB
18	G23-00001-29	2	TORX SCREW HD. 6-32 UNC x 1/4" LG.
17	V11-22000-67	1	HANDLE ASSY.
16	V12-40000-03	1	HUMIDIFIER STANDOFF
14	V11-41000-03	1	UPPER CASE COVER
10	V11-35100-03	3	FILTER THUMB SCREW
9	V11-36000-26	1	O-RING 50 DUROMETER SILICONE
8	V11-35200-07	1	FILTER COVER
5	V11-35100-03	1	CASE SIDE PLATE RIGHT
1	V11-12100-03	1	LOWER CASE COVER
No.	PART NUMBER	QTY.	DESCRIPTION AND REFERENCE DESIGNATION

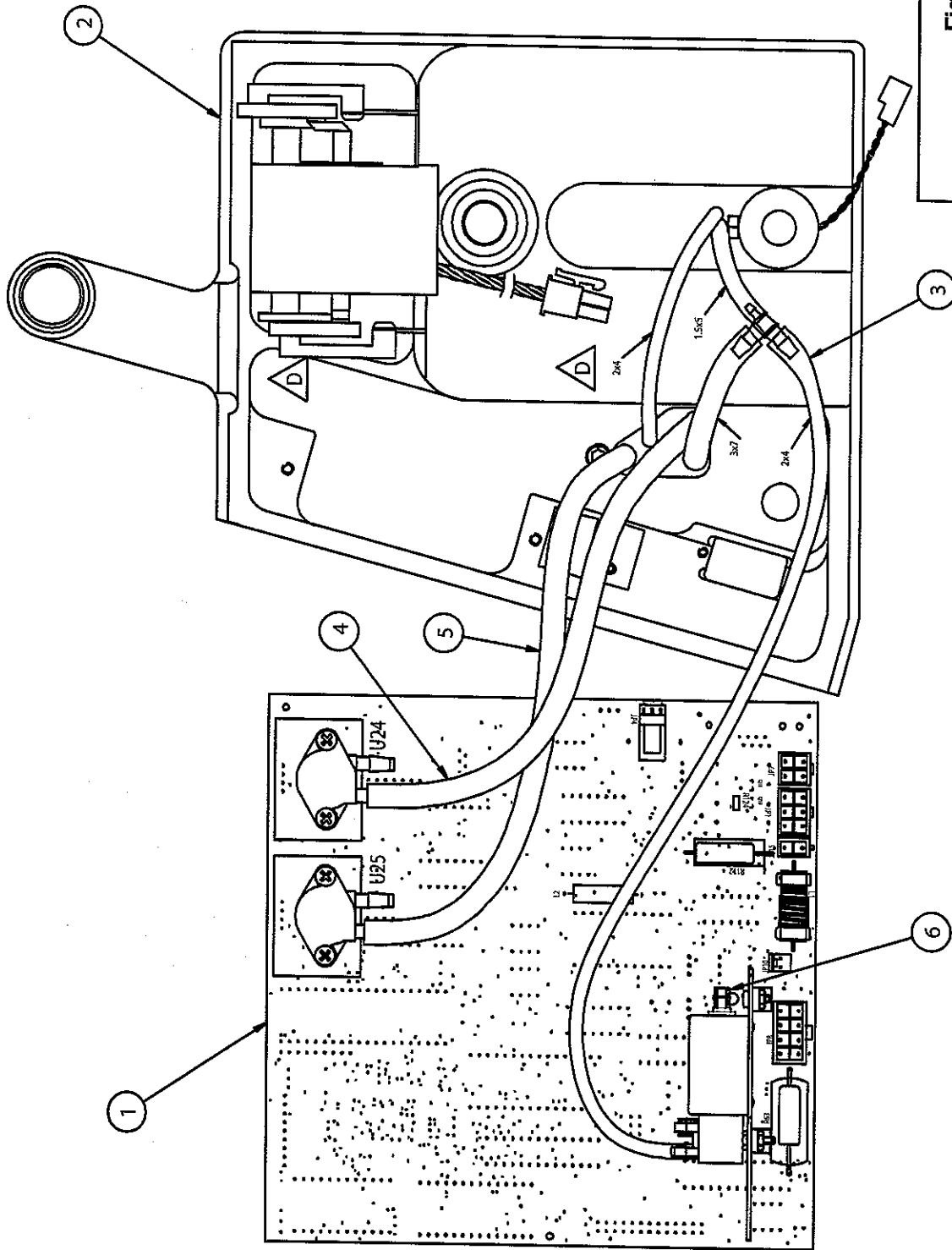
**Figure 9-2**  
**Final Assembly**  
**Front View HT50-H**

SERHT50 B0601

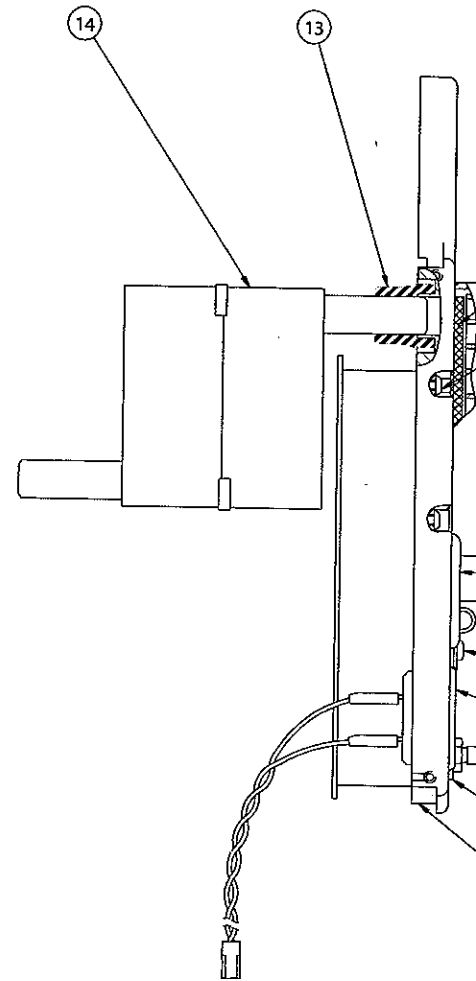
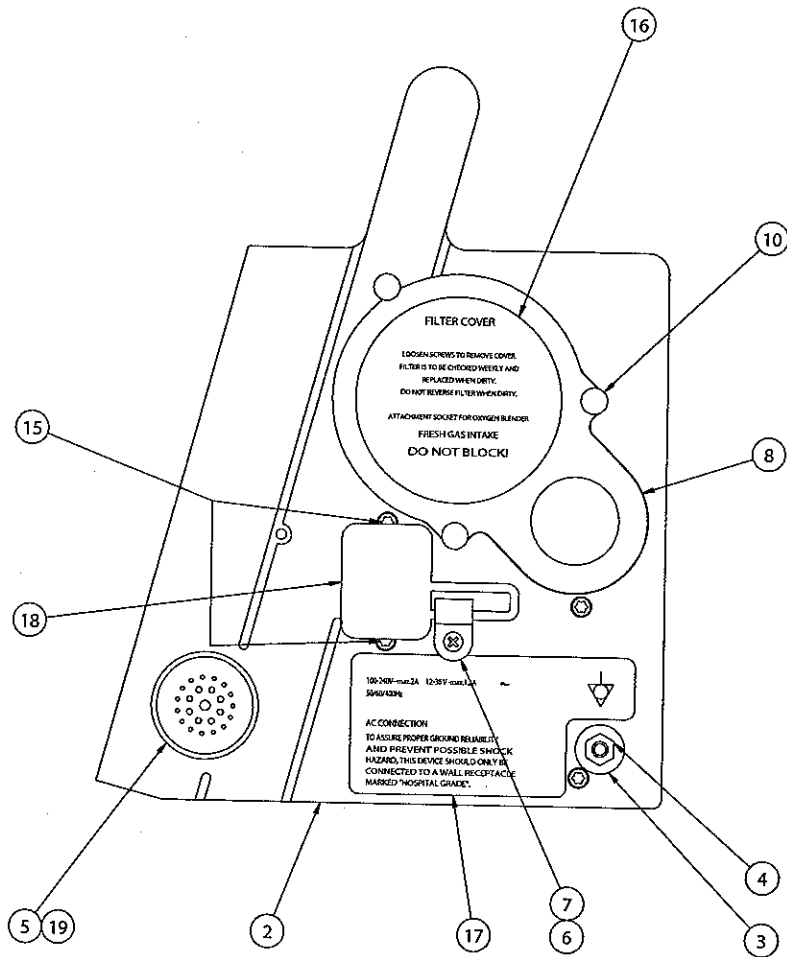


**Figure 9-3**  
**Final Assembly**  
**Front View HT50-T, HT50-H1**

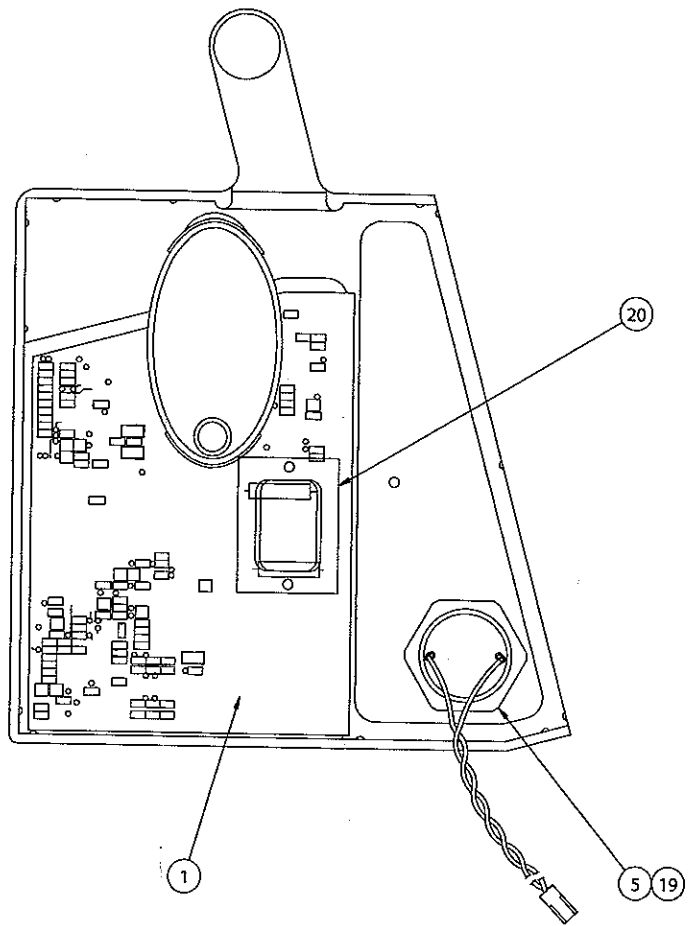
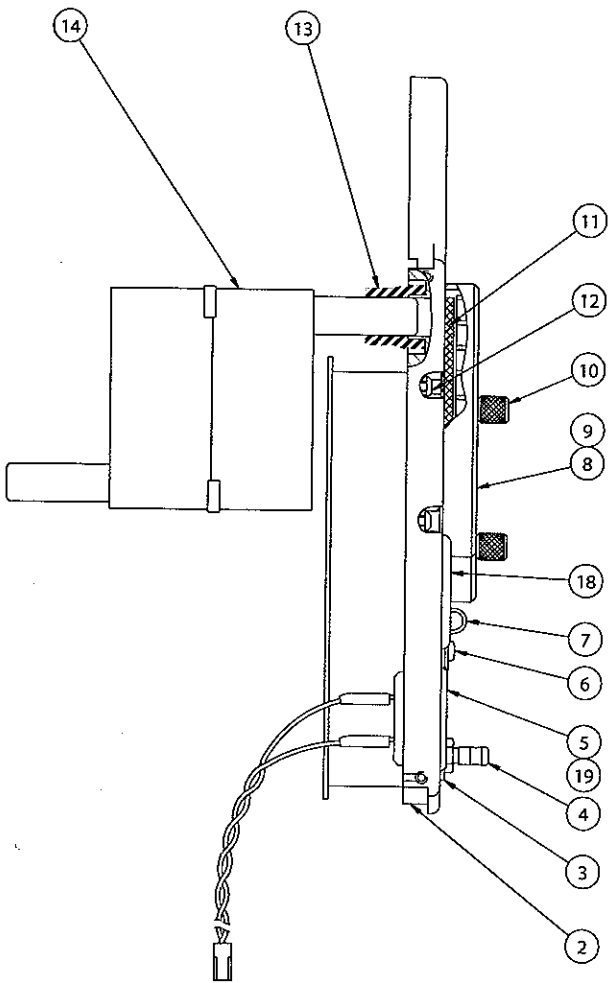




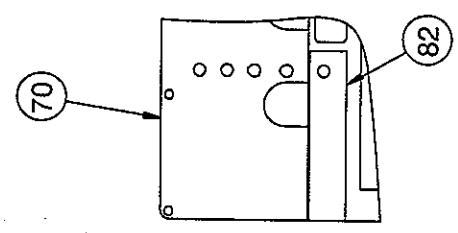
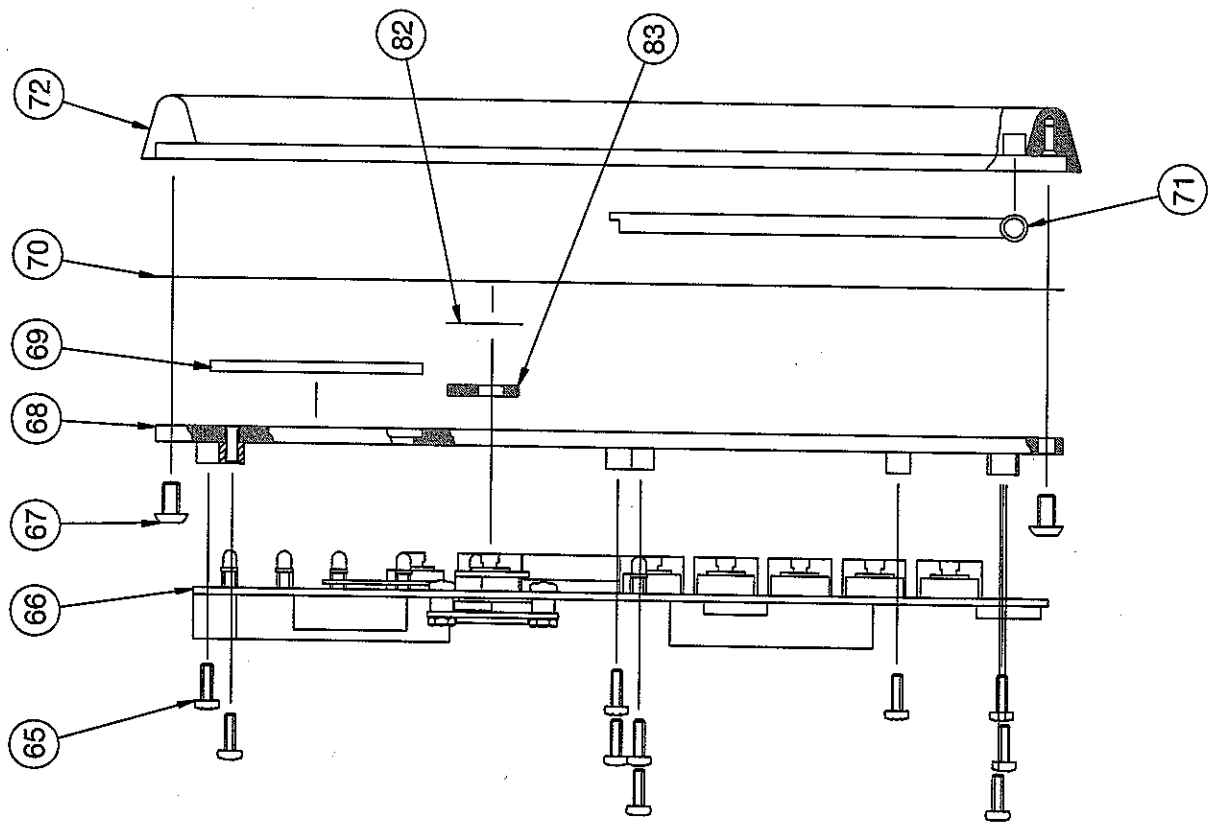
**Figure 9-5**  
**Main Board Tubing Connection,**  
**Left Side**



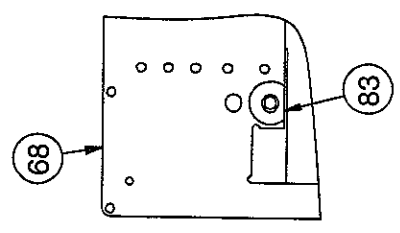
20	V11-38500-06	1	GASKET-POWER
19		1	O-RING ?? DUROMETER SILICONE
18	V11-34300-06	1	POWER CORD PORT PLUG (FOR HT50-T ONLY)
17	V11-38200-18	1	RIGHT SIDE LABEL
16	V11-35400-18	1	FILTER COVER LABEL
15	G23-00001-23	2	TORX HD. SCREW 6-32 UNC x 5/8" LG.
14	V11-33000-67	1	MUFFLER ASSY.
13	V11-32000-06	1	SILICONE TUBE 1/2"x3/4" 20mm
12	G23-00002-23	4	TORX HD. SCREW 6-32 UNC x 1/4" LG.
11	V11-35300-20	1	AIR INLET FILTER
10	V11-35100-03	3	FILTER THUMBS
9	V11-36000-26	1	O-RING 50 DUROMETER SILICONE
8	V11-35200-07	1	FILTER COVER
7	G23-00002-27	1	FIXED DIA. CABLE CLAMP 1/4"
6	G23-00013-23	1	PHIL. HEAD SCREW 8-32 x 1/4"
5	V11-37000-69	1	ALARM ASSY.
4	V11-38400-03	1	EQUIPOTENTIAL CONNECTOR (CUT)
3	G13-00002-23	1	EQUIPOTENTIAL COLOR CODE WASHER FR-POAG-S
2	V11-38100-03	1	CASE SIDE PLATE RIGHT
1	V11-31000-65	1	POWER SUPPLY ASSY.
No.	PART NUMBER	QTY.	DESCRIPTION AND REFERENCE DESIGNATION



**Figure 9-6**  
**Right Side Case**



STEP A



STEP B

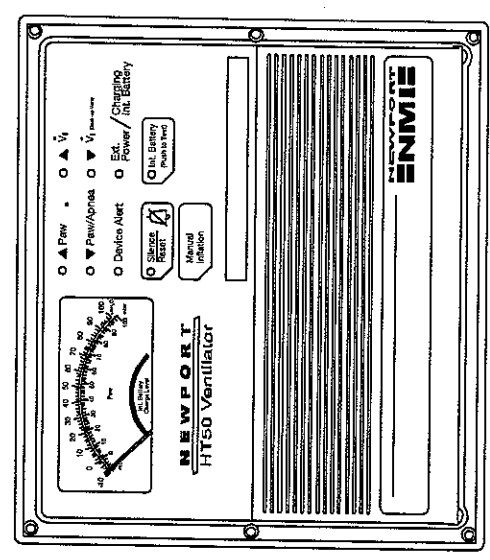
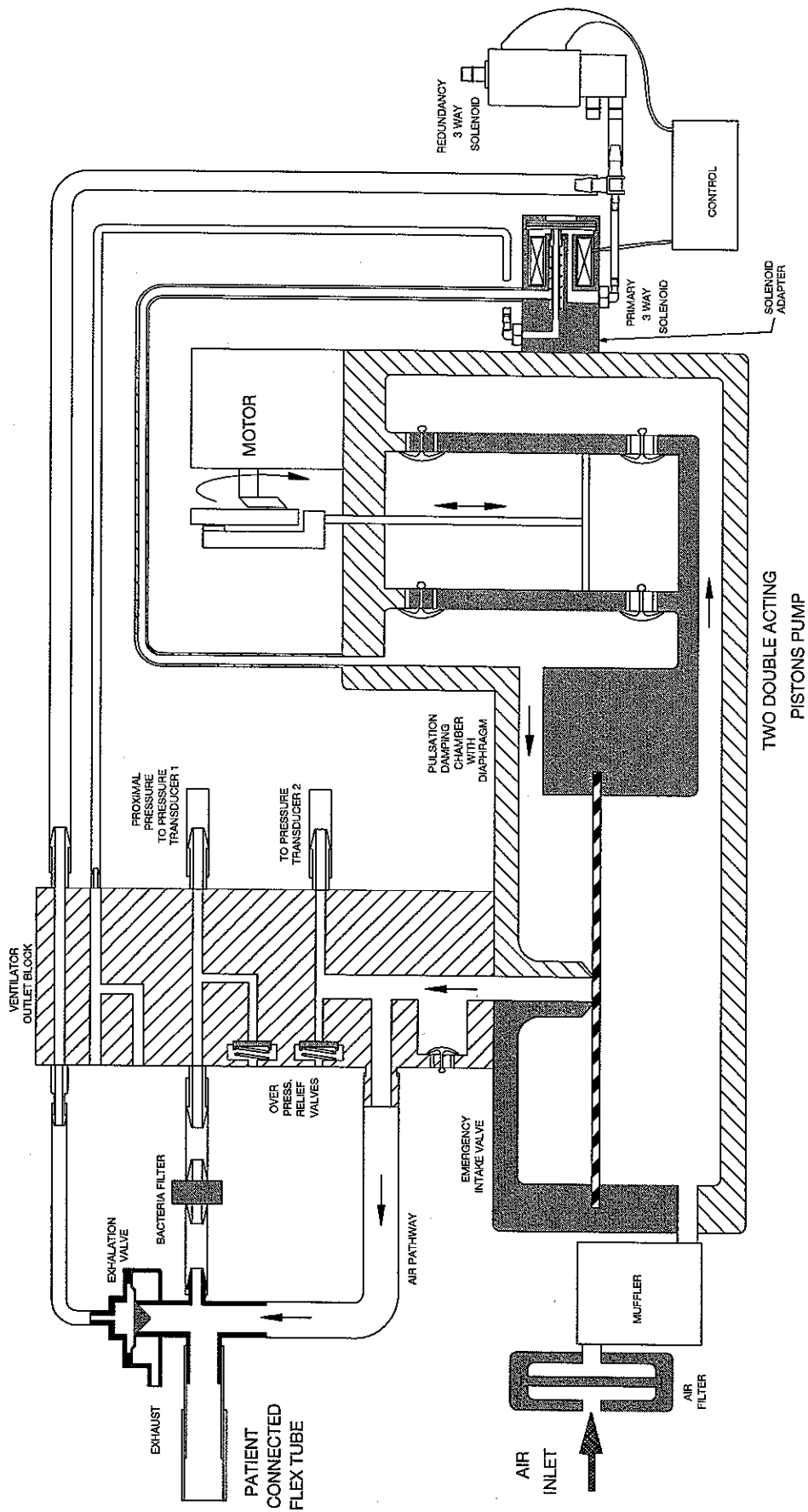
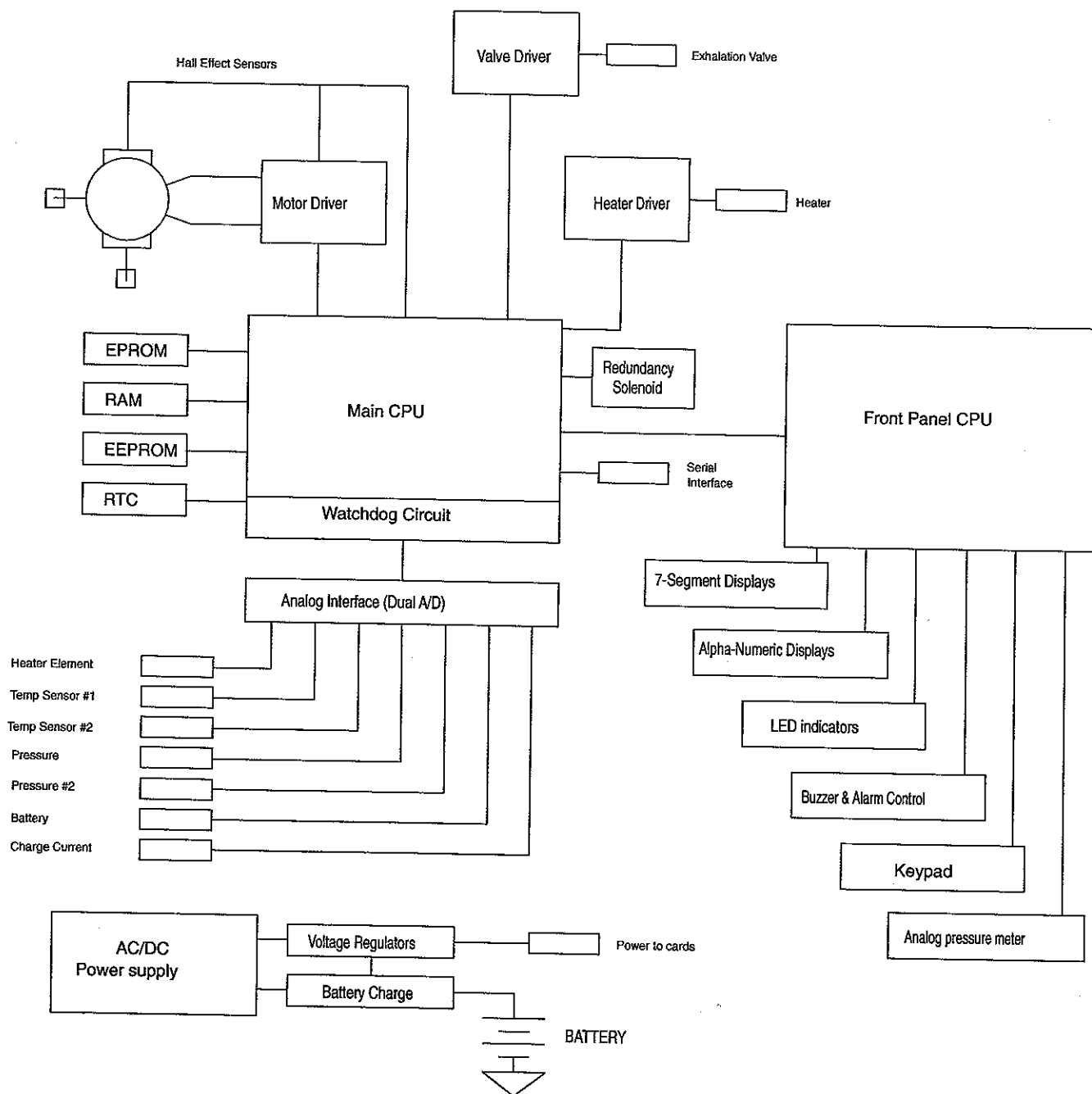


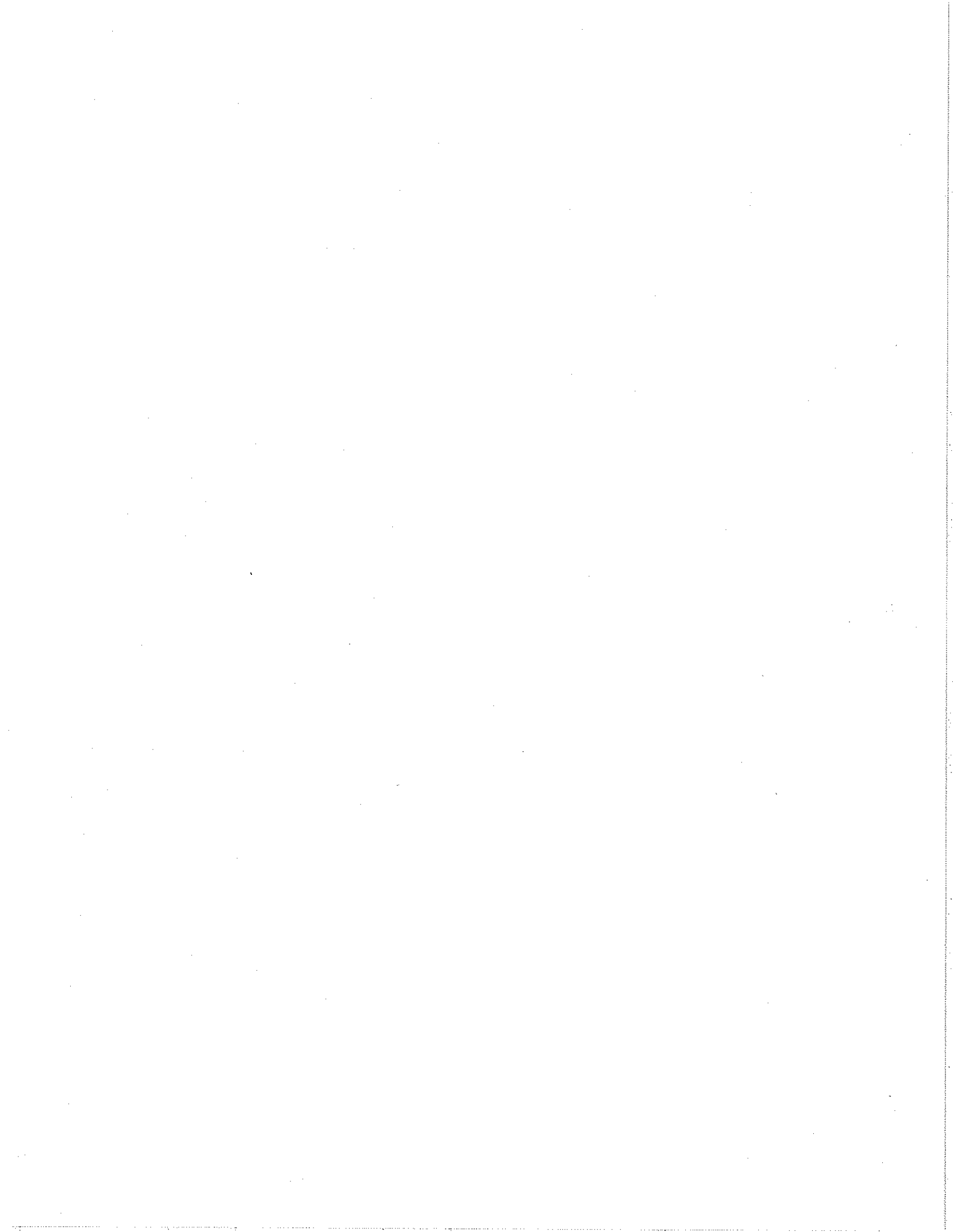
Figure 9-7  
Front Panel, Side View



**Figure 9-8  
Pneumatic Schematic**

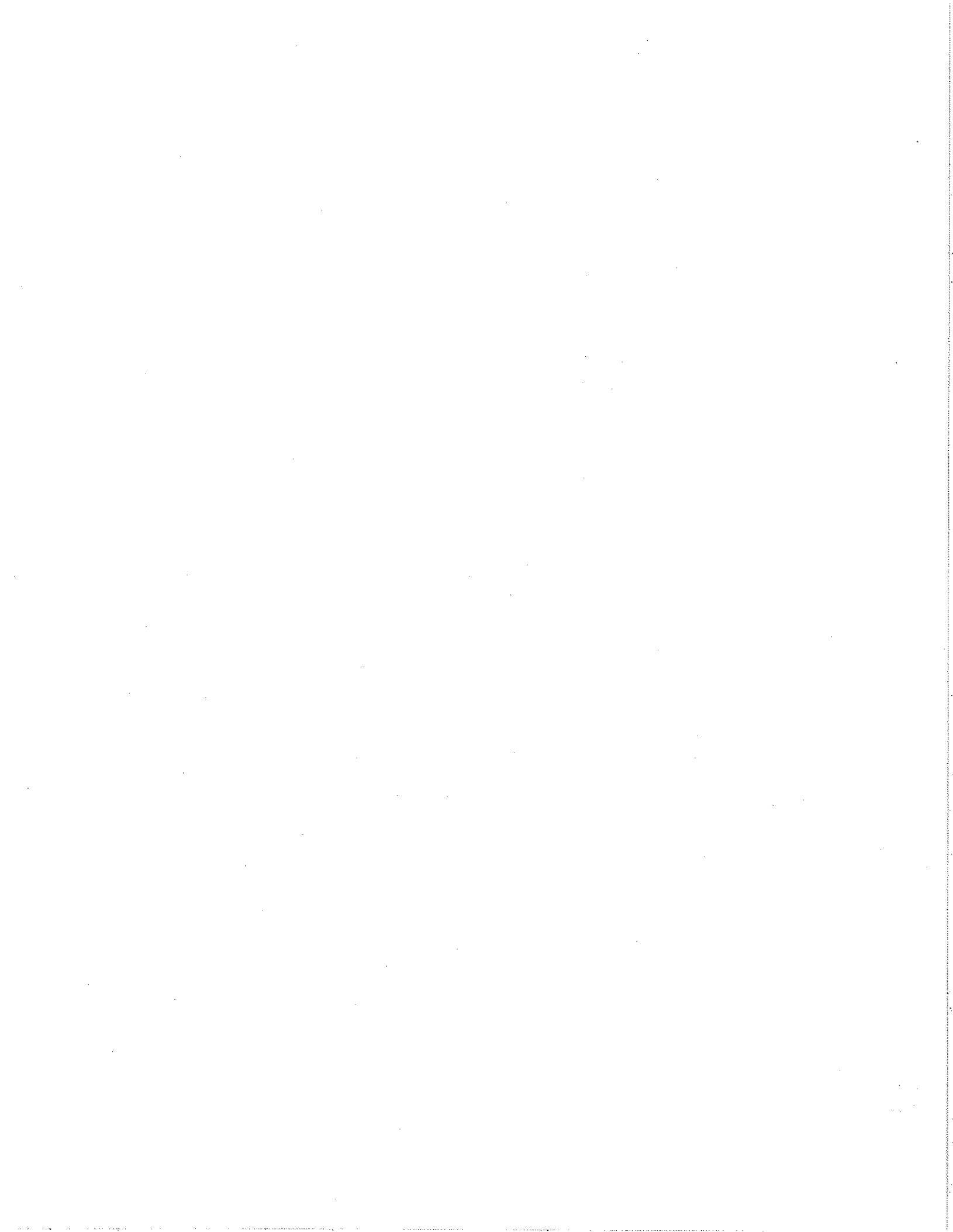


**Figure 9-9  
Electrical System Overview**



## Drawing Reference List

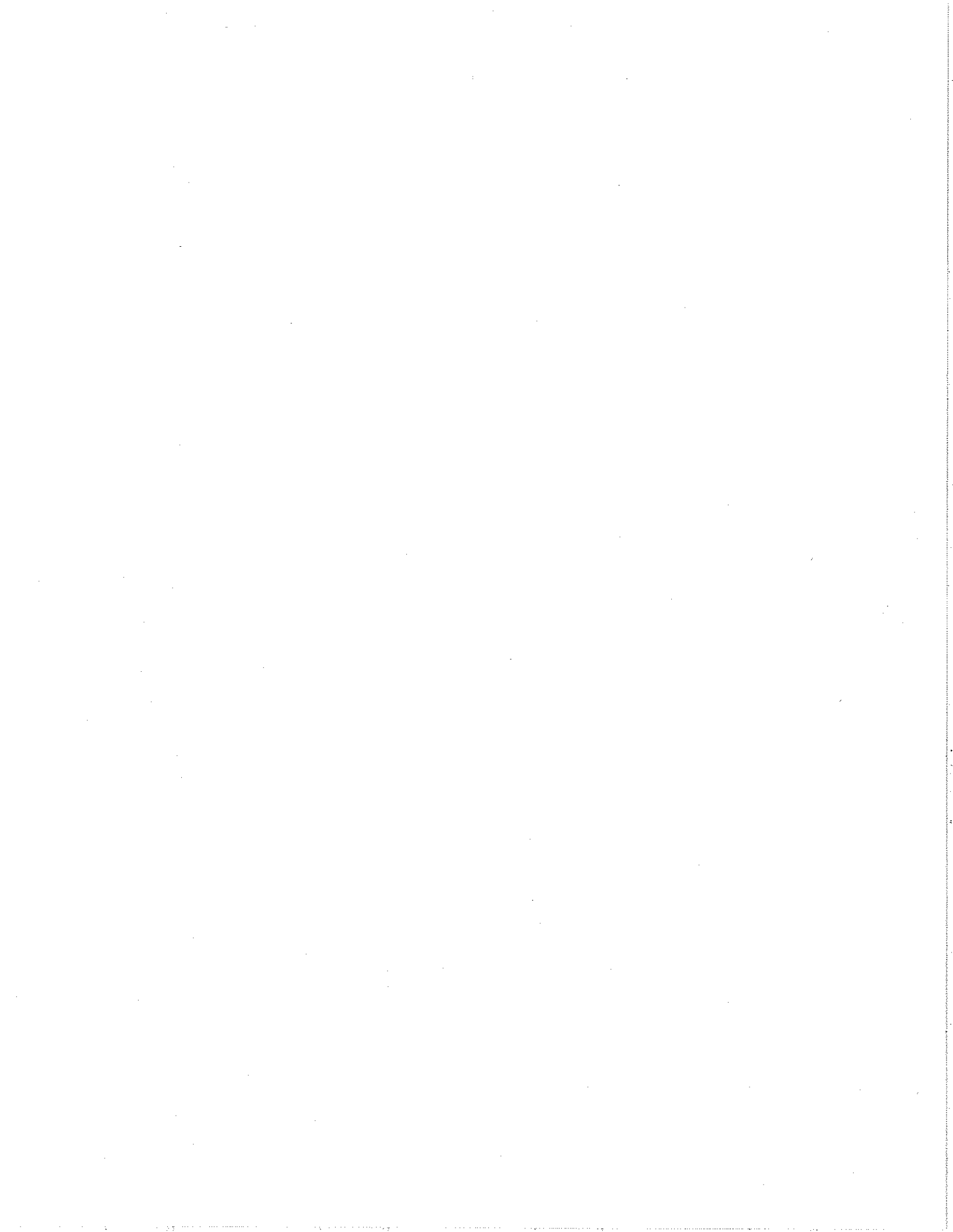
Item No.	Description of Part	Part Number
2	Battery Case Cover	V11-14000-07
3	Battery Cable w/ Fuse	V11-11200-69
4, 6, 18, 28, 31, 35, 46, 52, 53, 61, 63, 67	Torx Screw, 6-32 x 1/4"	G23-00001-23
7	Battery	G19-00001-29
8	Air Inlet Filter Cover Assembly	V11-35000-63
9	Air Inlet Filter Cover O-ring	V11-36000-26
11	Air Inlet Filter (5 pk)	HT460300
12	Silicone Tube, Muffler	V11-32000-06
13	Muffler Assembly.	V11-33000-67
19	Knob, Humidifier Bracket	V12-22000-03
20	Cap Screw, 1/4" x 1-1/4"	G23-00021-23
21	Humidifier Bracket	V12-21000-03
22	Humid. Bottle, Upper	HT460910
23	Absorbent Paper (10 pk)	HT460960
24	Humid. Bottle, Lower	HT460920
25	Humid. Heat Sink	HT460930
26	Humid. Heater Assembly	V12-10000-60
27	Torx Screw, K35 x 10	G23-00006-23
29	Pump Diaphragm	V11-21700-06
30	Outlet Assembly., HT50-H	V10-24000-63
30	Outlet Assembly, HT50-T, HT50-H1	V11-24000-63
32	Pump (manifold) Assembly	V11-21000-60
34	Rubber Foot	G01-00001-67
38	Silicone Tubing Kit, Solenoid	V11-26000-60
39,40	Silicone Tubes, Transducer	V11-28000-06
42	Plug, Alarm Comm. Port	V11-29000-06
43	Temp. Probe Conn. Kit	V11-25000-60
45	Plug, Temp. Probe (HT50-T, -H1)	V11-27100-06
47	Power Supply Assembly	V11-31001-65
49	Cap Screw, 6/32" x 1/4"	G23-00031-23
50	Main PCB Assembly.	V11-61001-05
58, 65	Pan Head Screw, 4-40 x 1/4"	G23-00014-23
60	Flat Cable Assembly, Panel to Main PCB	V11-78000-69
66	Panel PCB Assembly	V11-71000-65
68	Front Panel Assembly, Eng. (no bezel)	V11-72000-63
71	Cover Assembly, Control Panel	V11-75000-67
72	Bezel Assembly	V11-77000-03
74	Alarm Assembly	V11-37000-69
76	Phillips Screw, 8-32 x 1/4"	G23-00013-23
EXCHANGE PARTS		
74	Alarm Assembly, Exchange	V11-37000-69x
29	Pump Assembly, Exchange	V11-21000-60X
47	Power Supply Assembly, Exchange	V11-31100-65X
66	Panel PCB, Exchange	V11-71000-65X
50	Main PCB, Exchange	V11-61002-05X
43	Temp.Probe Input, Exchange	V11-25000-60X



---

# 10. REPACKAGING AND SHIPPING INSTRUCTIONS

Introduction .....	10-1
RGA (Return Goods Authorization) .....	10-1
Packaging: Complete Unit .....	10-1
Packaging: Parts or Accessories .....	10-2



---

**INTRODUCTION**

This section will help ensure that returns are properly packaged, the risk of shipping damage is reduced and that the return is delivered to the correct department within Newport Medical Instruments. Please follow the instructions below. This will help you avoid any inconveniences or delays when returning merchandise.

**RGA (RETURN GOODS AUTHORIZATION)**

1. All returns to Newport Medical Instruments must have an RGA number assigned. Returning goods without an RGA number could delay service, replacement or credit issues.
2. To obtain an RGA number please call Newport Medical Instruments during business hours (800.451.3111 or 949.642.3910) or email TechSupport@NewportNMI.com. Dial extension 500 for any parts or products being returned to the Technical Service Department for maintenance, warranty or non-warranty repairs. Dial extension 282 (Customer Service Department) or email Customers@NewportNMI.com for all other returns or FAX your request to 949.548.3091, attention Customer Service.

**PACKAGING: COMPLETE UNIT**

1. When returning an HT50 Ventilator, the original box and packaging must be used. If you do not have the original box and packaging, please contact the Technical Service Department at extension 500 to have one shipped to you.
2. Remove all accessories from the ventilator.
3. Do not ship any accessories unless they are requested by a Technician.
4. Once the ventilator is sealed in the box, write the RGA number on the shipping label.
5. When addressing the shipping label, use the "Courier Deliveries" address: Newport Medical Instruments, 760 West 16th Street, Building B, Costa Mesa, California, USA 92627.

# REPACKAGING AND SHIPPING INSTRUCTIONS

---

## PACKAGING: PARTS OR ACCESSORIES

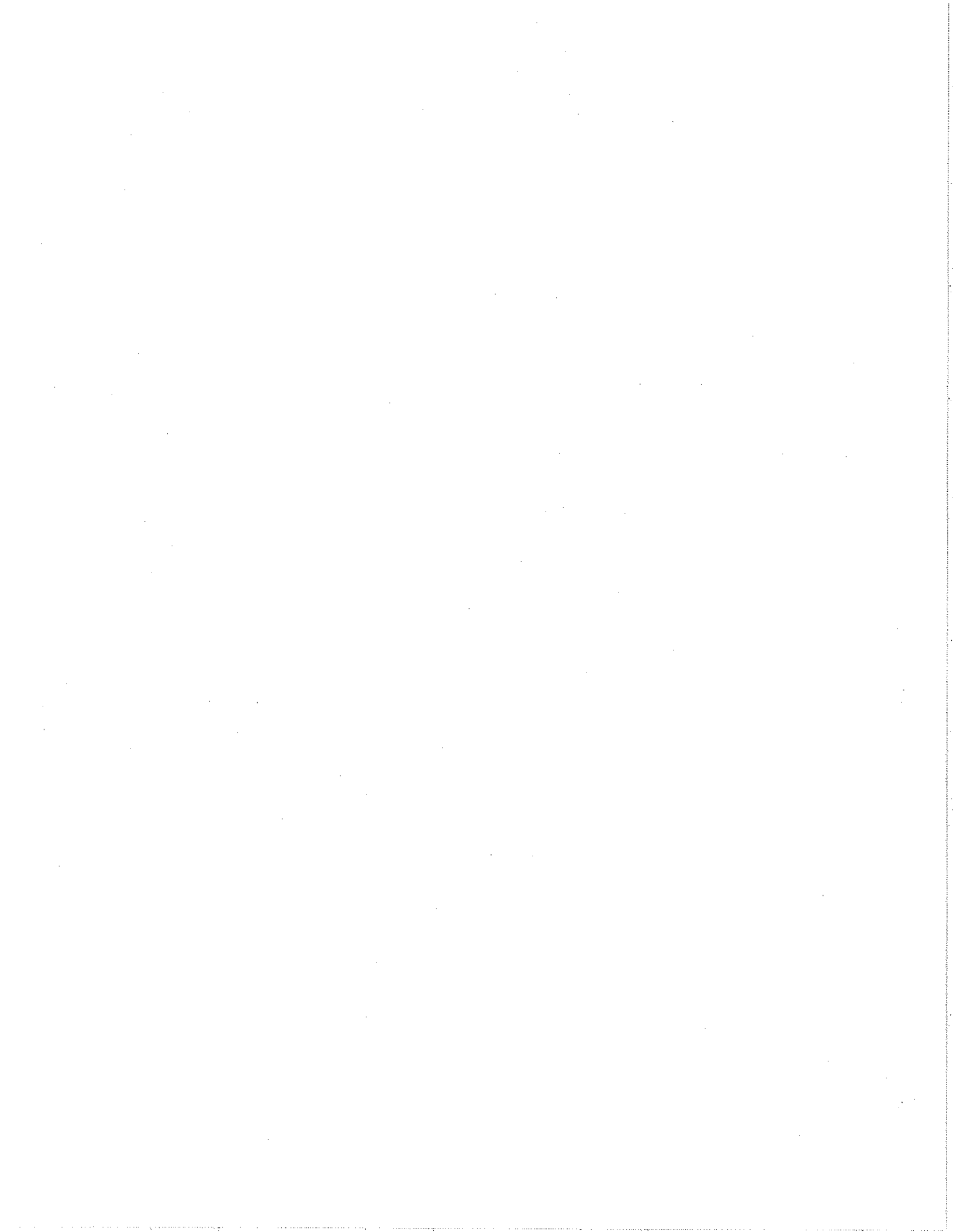
1. When returning any parts or accessories, please package them in a large enough box that the parts or accessories can be wrapped in a sufficient amount of packaging materials.
2. Once the parts or accessories are sealed in the box, write the RGA number on the shipping label.
3. When addressing the shipping label, use the "Courier Deliveries" address: Newport Medical Instruments, 760 West 16th Street, Building B, Costa Mesa, California, USA 92627.

**NOTE:** When calling Newport Medical Instruments regarding a return, please have your assigned RGA number available to avoid any delays in answering your inquiry.

---

# APPENDIX A: PARTS AND ACCESSORIES

Parts and Accessories..... A-1



**HT50 Ventilator Accessories**

For more details see your NEWPORT representative or contact NEWPORT Customer Service Department.

Part Number	Description	Quantity
<b>HUMIDIFIER ACCESSORIES</b>		
HT460910	Humidifier Bottle – upper	1
HT460920	Humidifier Bottle – lower	1
HT460930	Humidifier – heat sink	1
HT460940	Humidifier – airway temperature probe	1
HT460950	Humidifier – hose connection (6 in)	1
HT460960	Humidifier – absorbent paper	10/ea
<b>AIR/OXYGEN MIXER</b>		
HT460700	Air/oxygen mixer – DISS 1240	1
HT600044	Oxygen blending bag kit (1L)	1
<b>PATIENT BREATHING CIRCUITS</b>		
HT600050	Patient breathing circuit – disposable with prox line, exh. valve	10/ea
HT600047	Patient breathing circuit – permanent with prox line, water trap, exh. valve	1
HT600048	Patient breathing circuit – permanent with prox line, water trap	1
HT600045	Patient breathing circuit – permanent with prox line, exh. valve	1
HT600049	Patient breathing circuit – permanent with prox line	1
HT600039	Exhalation valve	1
<b>MOUNTING ACCESSORIES</b>		
HT460230	Compact stand assembly with support arm and breathing circuit hanger	1
HT460200	Bed bracket (headboard)	1
<b>MISCELLANEOUS ACCESSORIES</b>		
HT460300	Air inlet particle filter (disposable)	5/ea
LNG600P	Adult test lung (500 mL)	1
PWR290P	Electrical power cord / A.C.	1
HT460400	Power cord ferrite	1
HT460085	Automobile 12 V accessory power cord	1
OPRHT50-1	Operating manual for HT50	1
SERHT50	Service manual for HT50	1
HT6004701	Prox inline filters (disposable)	5/ea
RP50	Parabolic Resistor (test device)	1
V15-23000-07	Breathing Circuit Hanger	1
V15-22000-07 N	Support Arm Plug	1
V15-21000-03 N	Support Arm Rod	1
V15-12000-03 N	Compact Stand Thumbscrew	1
V15-11200-03 N	Compact Stand Tray	1

Contact NEWPORT or your local NEWPORT representative for pricing and availability on all accessories and parts listed.

## PARTS AND ACCESSORIES

### Service Parts List

Part Number	Description of Part
V11-14000-07	Battery Case Cover
V11-11200-69	Battery Cable w/ Fuse
G23-00001-23	Torx Screw, 6-32 x 1/4"
G19-00001-29	Battery
V11-35000-63	Air Inlet Filter Cover Assembly.
V11-36000-26	Air Inlet Filter Cover O-ring
HT460300	Air Inlet Filter (5 pk)
V11-32000-06	Silicone Tube, Muffler
V11-33000-67	Muffler Assembly.
V12-22000-03	Knob, Humidifier Bracket
G23-00021-23	Cap Screw, 1/4" x 1-1/4"
V12-21000-03	Humidifier Bracket
HT460910	Humid. Bottle, Upper
HT460960	Absorbent Paper (10 pk)
HT460920	Humid. Bottle, Lower
HT460930	Humid. Heat Sink
V12-10000-60	Humid. Heater Assembly.
G23-00006-23	Torx Screw, K35 x 10
V11-21700-06	Pump Diaphragm
V10-24000-63	Outlet Assembly, HT50-H
V11-24000-63	Outlet Assembly, HT50-T, HT50-H1
V11-21000-60	Pump (manifold) Assembly.
G01-00001-67	Rubber Foot
V11-26000-60	Silicone Tubing Kit, Solenoid
V11-28000-06	Silicone Tubes, Transducer
V11-29000-06	Plug, Alarm Comm. Port
V11-25000-60	Temp. Probe Conn. Kit
V11-27100-06	Plug, Temp. Probe (HT50-T, -H1)
V11-31001-65	Power Supply Assembly.
G23-00031-23	Cap Screw, 6/32" x 1/4"
V11-61001-05	Main PCB Assembly.
G23-00014-23	Pan Head Screw, 4-40 x 1/4"
V11-78000-69	Flat Cable Assembly, Panel to Main PCB
V11-71000-65	Panel PCB Assembly
V11-72000-63	Front Panel Assembly, Eng. (no bezel)
V11-75000-67	Cover Assembly, Control Panel
V11-77000-03	Bezel Assembly
V11-37000-69	Alarm Assembly
G23-00013-23	Phillips Screw, 8-32 x 1/4"
V11-24700-67	Emergency Intake Valve Assembly
R26-00204-26	Silicone Tube Assembly, Sol. to Outlet

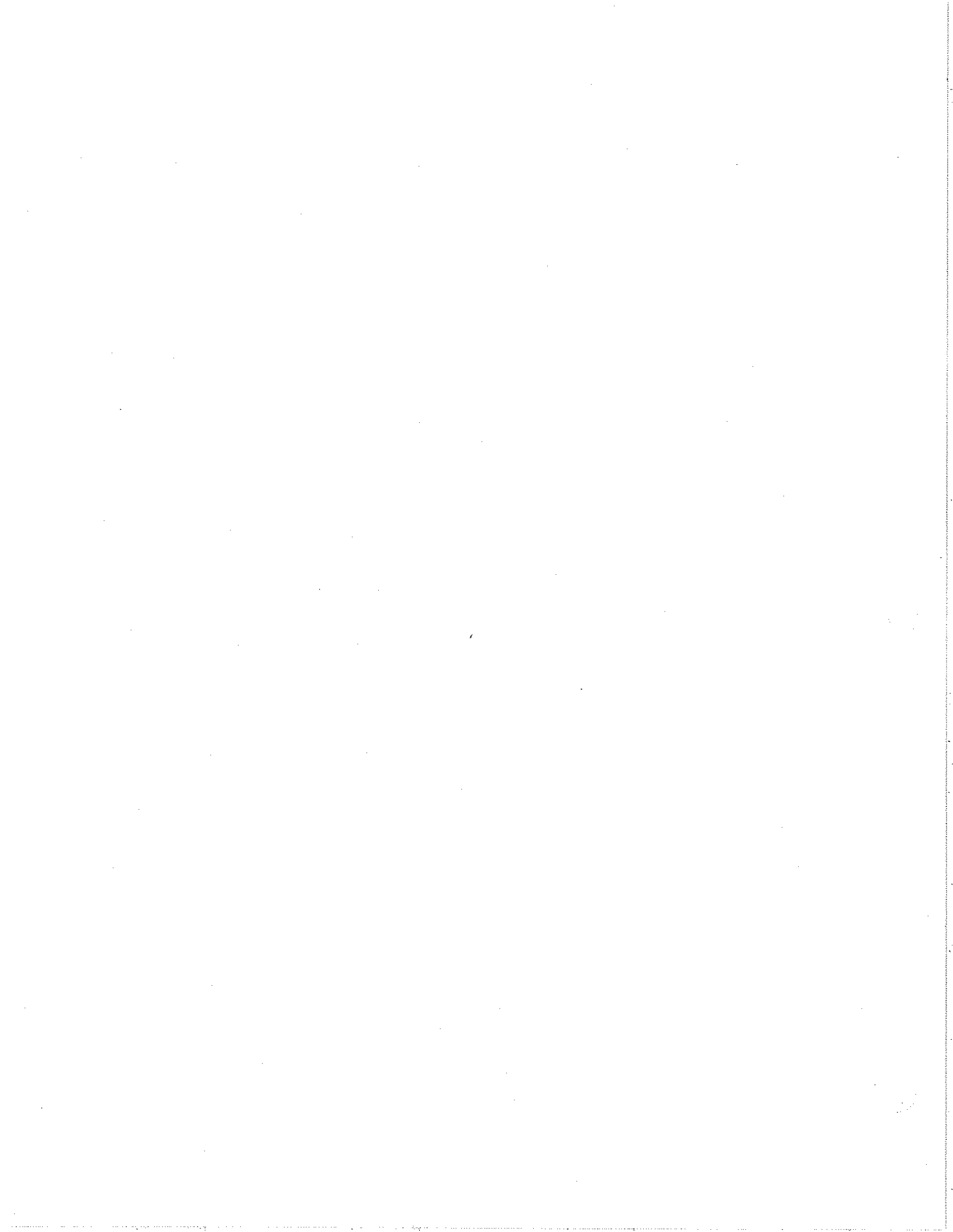
## Exchange Parts

Part Number	Description of Part
V11-37000-69X	Alarm Assembly, Exchange
V11-21000-60X	Pump Assembly, Exchange
V11-31100-65X	Power Supply Assembly, Exchange
V11-71000-65X	Panel PCB, Exchange
V11-61002-05X	Main PCB, Exchange
V11-25000-60X	Temp.Probe Input, Exchange

## Conversion Adapters

(allows mating between original connector board and new style connectors)

Part Number	Description of Part
G10-0001-29	Adapter (new temp. probe to old MB)
G10-0002-29	Adapter (old temp.probe to new MB)
G10-0003-29	Adapter (new solenoid/buzzer to old MB/PB)
G10-0004-29	Adapter (old solenoid/buzzer to new MB/PB)
<b>NOTE:</b> Appropriate adapter included with exchange parts assemblies.	



**Miscellaneous**

↑ – PEEP Too Low 3-25  
10V Shutdown 3-22

**A**

A/CMV (Assist/Control Mandatory Ventilation)  
3-7, 4-2

Accessories List A-1

Air Inlet Particle Filter  
Filter Cover 3-26

Air/Oxygen Entrainment Mixer 3-27  
Specifications 2-7

Airway Pressure Connector 3-25

Alarm Loudness. See Buzzer Volume

Alarm Messages 2-3, 3-23

**Alarms**

Apnea 3-19

Battery Empty 3-21

BatteryLow 3-21

Check Prox Line 3-19

Device Alert 3-22

High Airway Pressure 3-16

High Baseline Pressure 3-18

High Insp. Min. Volume 3-17

Humidifier Alarms 3-20

Low Airway Pressure 3-16

Low Baseline Pressure 3-19

Low Insp. Min. Volume 3-17

Occlusion 3-18

PCV Not Reached 3-20

Power Switchover 3-22

Shut Down Alert 3-23

Apnea Alarm 3-19

Auto Panel Lock 3-31

Enabling/Disabling 3-3

**B**

Back-Up Ventilation 4-5

A/CMV and SIMV 4-5

Activation 4-5

Cancellation 4-5

Spont 4-5

Battery. See Internal Battery

Battery Empty Alarm 3-21

Battery Low Alarm 3-21

Breathing Circuit

Part numbers A-1

BUV. See Back-up Ventilation

Buzzer Volume 3-30

**C**

Changing a Parameter 3-2

Changing between Pressure and Volume  
Control 3-2

Changing the MODE Control 3-1

Charge Fault Alarm 3-14

Check Humidifier Alarm 3-20

Check Prox Line Alarm 3-19

Check Temp Probe Alarm 3-20

Checking the battery. See Internal Battery

Checking the battery charge level. See Internal  
Battery

Communication Protocol 3-31

Compact Stand Assembly A-1

CPAP. See PEEP/CPAP

**D**

Device Alert 3-22

**E**

Emergency Air Intake 3-26

Equipotential Connector 3-27

Exhalation Valve Connector (Exh. Valve) 3-25

External Power Connector (A.C./D.C.) 3-26

**F**

Factory Default Parameters 2-6

Flow Rate. See  $\dot{V}$

$f$  (frequency) 3-9, 3-24

Fresh Gas Intake 3-26

Front Panel

Alarms 3-15

Controls & Indicators 3-6

Illustration 3-4, 3-5

Message Display Window 3-23

Overview 3-1

**G**

Gas Output Connector 3-25

**H**

- Hardware Requirements 2-5
- High Baseline Pressure Alarm 3-18
- High Insp. Minute Volume Alarm ( $\blacktriangle \dot{V}_I$ )
  - Alarm 3-17
  - Control & Display 3-16
- High Pressure Alarm ( $\blacktriangle P_{aw}$ )
  - Alarm 3-16
  - Control & Display 3-15
- High Prox Temp Alarm 3-20
- High Temp Core Alarm 3-20
- Home Caregiver Notes & Warnings 3-26, 3-27, 3-28, 3-30, 3-31
- Hour Meter. See User Set Up
- Humidifier
  - Alarms 3-20
  - Specifications 2-7
- Humidifier Fail Alarm 3-20
- Humidifier On Button 3-12

**I**

- I:E Ratio 3-13
- Inspiratory Minute Volume ( $\dot{V}_I$ ) 3-16, 3-24
- Inspiratory Time. See *t<sub>I</sub>*
- Intended Use 2-1
- Internal Battery
  - Alarms 3-21
  - Charge Level Meter 3-14
  - Recharge Time 3-14
  - Specifications 2-4
  - Test Button 3-13
- Inverse I:E Message 3-25
- Inverse I:E Ratio 3-13

**L**

- Left Side Connectors 3-25
- Low Baseline Pressure Alarm 3-19
- Low Insp. Minute Volume Alarm ( $\blacktriangledown \dot{V}_I$ )
  - Alarm 3-17
  - Back-up Ventilation. See Back-up Ventilation
  - Control & Display 3-16
- Low Pressure Alarm ( $\blacktriangledown P_{aw}$ )
  - Alarm 3-16
  - Control & Display 3-15

**M**

- Mandatory Flow. See  $\dot{V}$
- Manual Inflation 3-12
- Mean Paw 3-24
- Message Display Window 3-23
  - Alarm Messages 3-24
  - Monitoring Messages 3-23
  - Setting Limitations Messages 3-25
- Meter Adjust 3-31
- Mixer. See Air/Oxygen Entrainment Mixer
- Modes
  - A/CMV 3-7, 4-2
  - How to change 3-1
  - SIMV 3-7, 4-2
  - SPONT 3-8, 4-3
- Modes Control 3-7
- Motor Fault 3-22

**O**

- OCCL Shutdown 3-22
- Occlusion Alarm
  - Circuit 3-18
  - Device 3-18
- On/Standby Button 3-6
- Operator's Responsibility 1-1
- Oxygen Accessories. See Air/Oxygen Entrainment Mixer, Oxygen Blending Bag
- Oxygen Blending Bag 3-27
  - Specifications 2-8

**P**

Panel Lock. See Auto Panel Lock  
 Parameter Settings 2-6, 3-30  
 Patient Range 2-6  
 Paw Meter 3-15, 3-31  
 Paw, Base 3-24  
 Paw, Mean 3-24  
 Paw, Peak 3-24  
 PC - Peep Too Low 3-25  
 PCV Not Reached Alarm 3-20  
 Peep + PS Too High 3-25  
 PEEP/CPAP 3-11  
 Power Cord Ferrite 3-27  
 Power Save 3-29  
 Power Supply Requirement 2-5, 3-26  
 Power Switchover Alarm 3-22  
 Pressure Control 3-10, 4-4  
   Switch To Volume Control 3-2, 3-10  
 Pressure Support. See Psupport  
 Pressure Units 3-30  
 Psupport (Pressure Support) 3-11, 4-3  
 Ptrig (Sensitivity) 3-11  
 Push to Unlock Button 3-14

**R**

Reached Max I:E Message 3-25  
 Reached Max  $\dot{V}$  Message 3-25  
 Reached Min  $\dot{V}$  Message 3-25  
 Respiratory Frequency. See  $f$   
 Right Side Connectors 3-26  
 RS-232/RS-485 Interface  
   (Comm. Port) 3-26, 3-31

**S**

Sensitivity. See Ptrig  
 Setting Limitation Messages 3-25  
 Shut Down Alert 3-23, 3-30  
 Shut Down, How To 3-1  
 Silence/Reset 3-14  
 SIMV (Synchronized Intermittent Mandatory  
   Ventilation) 3-7, 4-2  
 Software Version 3-28  
 Specifications  
   Air/Oxygen Mixer 2-7  
   Controls/Alarms/Monitors 2-2  
   Hardware 2-5  
   Humidifier 2-7  
   Miscellaneous 2-5  
   Oxygen Blending Bag 2-8  
 SPONT Mode 3-8, 4-3  
 Start Up Parameter Setting. See User Set Up  
 Symbols/Labeling Table 2-1  
 System Error 3-22  
 System Overview 4-1

**T**

Target Pressure. See Pressure Control  
 Tech. Set Up. See User Set Up  
 Temperature Probe Connector  
   (Temp. Probe) 3-26  
 Theory of Operation 4-1 to 4-6  
 $t_i$  (inspiratory time) 3-9  
 Tidal Volume. See Volume Control  
 Transport Use 4-1  
 Trigger Sensitivity. See Ptrig  
 Turning On/Off the HT50 3-1

**U**

Unlock Panel. See Auto Panel Lock  
 Up and Down ( $\blacktriangle/\blacktriangledown$ ) Control 3-8  
 User Set Up 3-28  
   Exiting 3-31  
   How to access 3-28  
   Parameters 3-29

**V**

- V (Mandatory Flow) 3-13
- V Unavailable Message 3-25
- Volume Control 3-10, 4-4
  - Switch To Pressure Control 3-2, 3-11

**W**

- Warnings & Cautions, General 1-4
- Warranty 1-2 to 1-6