

SECTION A-A SCALE 1/4"=1'-0"  
50-13-1062

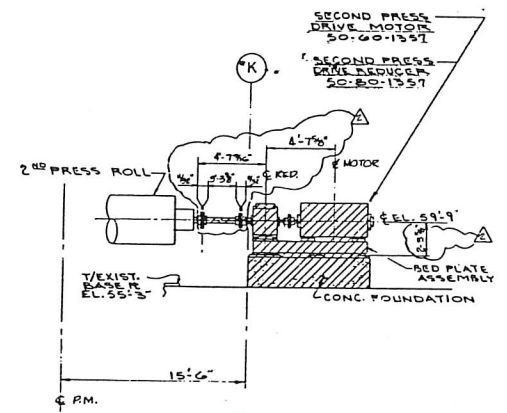

SECTION F-F SCALE 1/4"=1'-0"  
50-13-1061

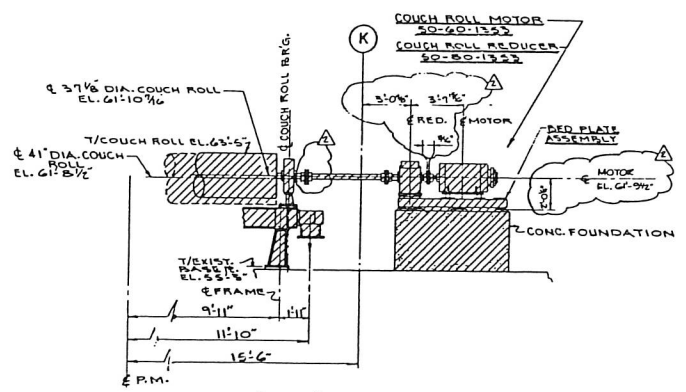

SECTION C-C SCALE 1/4"=1'-0"  
50-13-1061

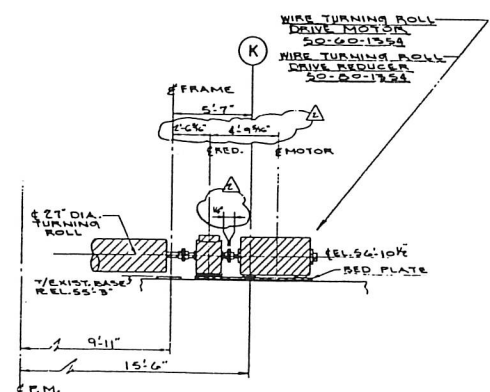

SECTION D-D SCALE 1/4"=1'-0"  
50-13-1061

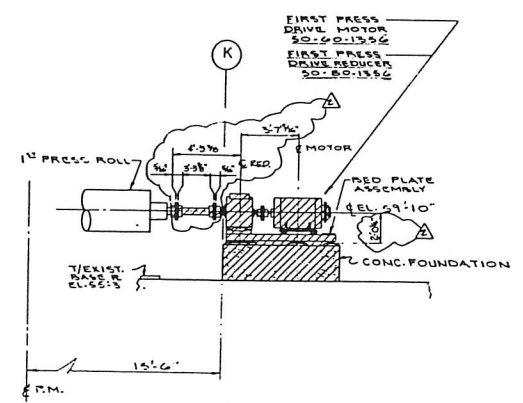

SECTION E-E SCALE 1/4"=1'-0"  
50-13-1061

APPROVED FOR CONSTRUCTION

<p>STONE CONTAINER CORPORATION UNCASVILLE, CONNECTICUT UNCASVILLE MODERNIZATION-1988</p>										<p>APPROVED: [Signature] DATE: [Date] SCALE: [Scale] NOTED: [Name] BY: [Name] DATE: [Date]</p>				<p>MACHINE ROOM GENERAL ARRANGEMENT SECTIONS</p>						
<p>2 TO MATCH YELLORE DRAWING ADDED COUPLINGS ON MOTORS</p>										<p>BY: [Name] DATE: [Date]</p>				<p>RELEASED FOR DESIGN</p>						
<p>1 SECTION "A-A" ADDED PAPER MACHINE HOOD TO</p>										<p>BY: [Name] DATE: [Date]</p>				<p>DWG. 50-13-1081</p>						
<p>0 REDRAWN RELEASED FOR DESIGN</p>										<p>BY: [Name] DATE: [Date]</p>				<p>REV [Number]</p>						
NO. REV.	DESCRIPTION	BY	DATE	APP'D	REV	DESCRIPTION	BY	DATE	APP'D	REV	PRELIMINARY ISSUE	BY	DATE	APP'D	REV	PRELIMINARY ISSUE	BY	DATE	APP'D	REV

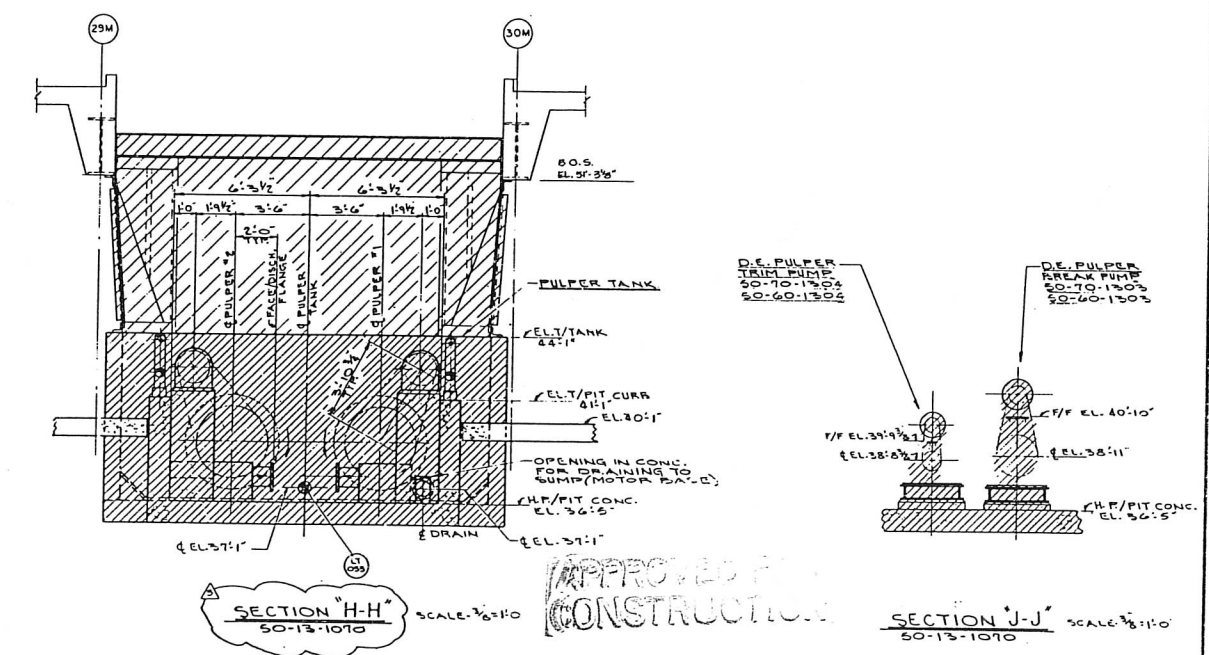
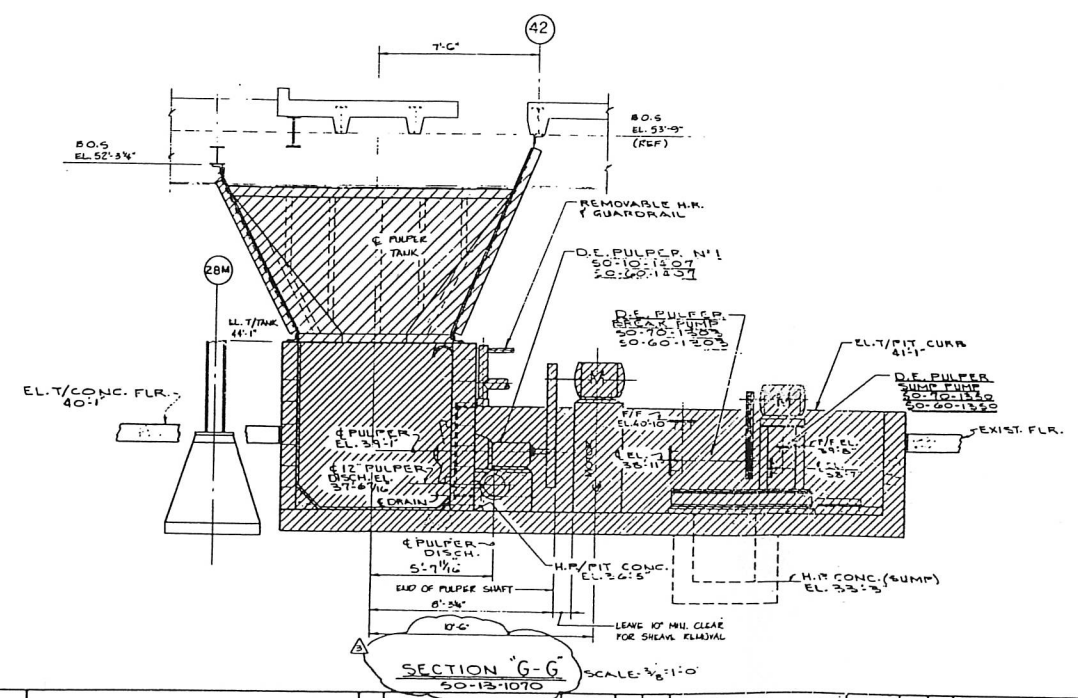
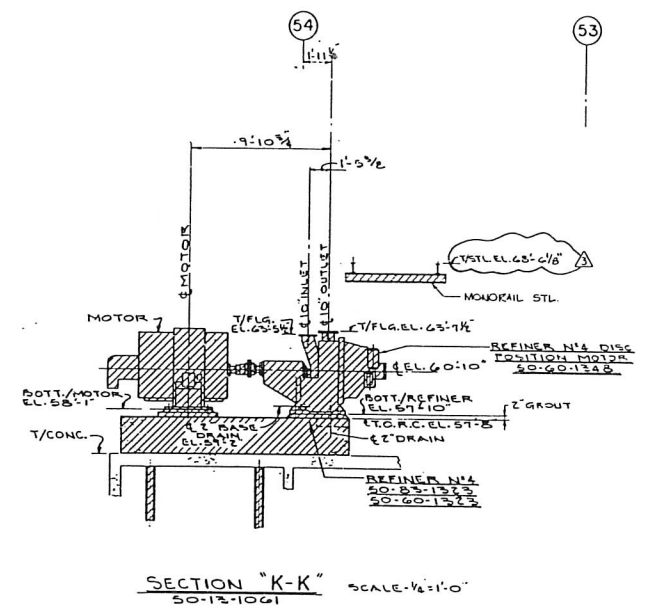
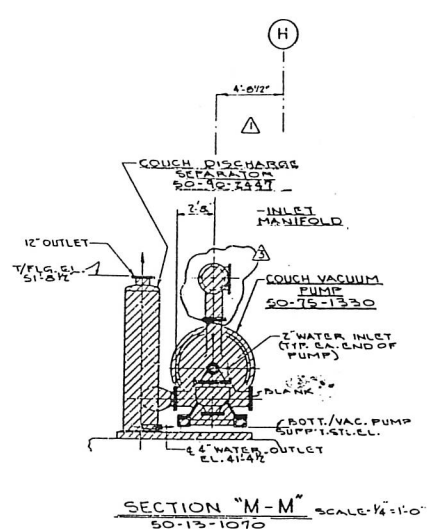
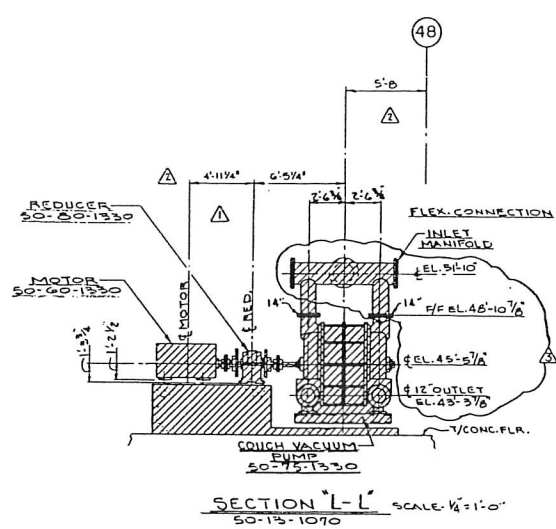

REV	DATE	BY	APP'D	DESCRIPTION	REV	DATE	BY	APP'D	DESCRIPTION
2	11/11/79	JNS	JNS	REVISED FOR DESIGN					
1	11/11/79	JNS	JNS	REVISED FOR DESIGN					
0				REVISED FOR DESIGN					

APPROVED	SCALE	NOTED	DATE	NO.	REV.

PROJECT NO.	7641
DATE	J. R. 12 14 9 88
BY	JNS
APP'D	JNS

DESIGN	REV
DWG. 50-13-1082	REV

APPROVED FOR CONSTRUCTION

STONE CONTAINER CORPORATION  
UNCASVILLE, CONNECTICUT  
UNCASVILLE MODERNIZATION-1988

MACHINE ROOM  
GENERAL ARRANGEMENT  
SECTIONS



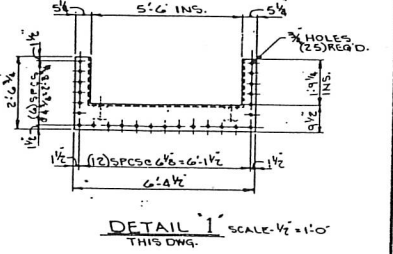
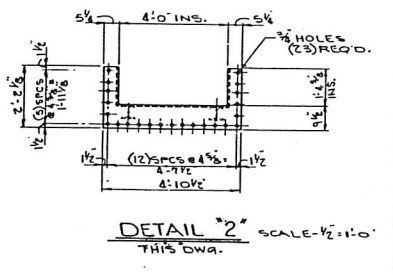
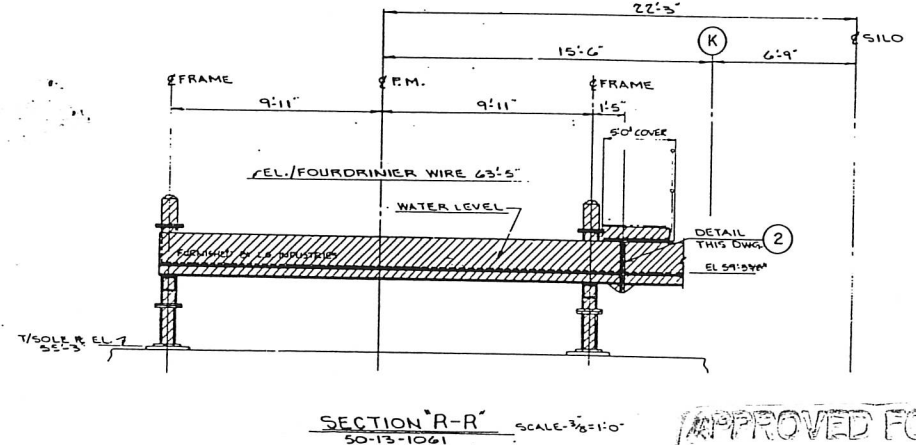
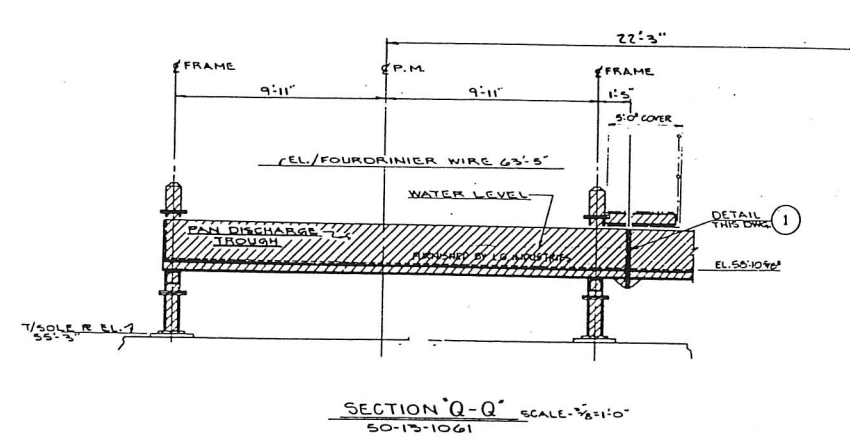
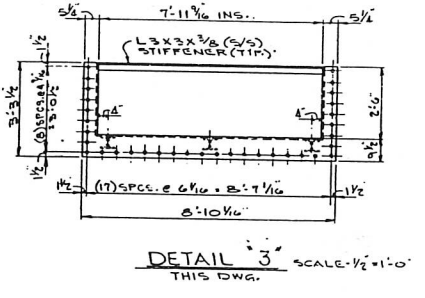
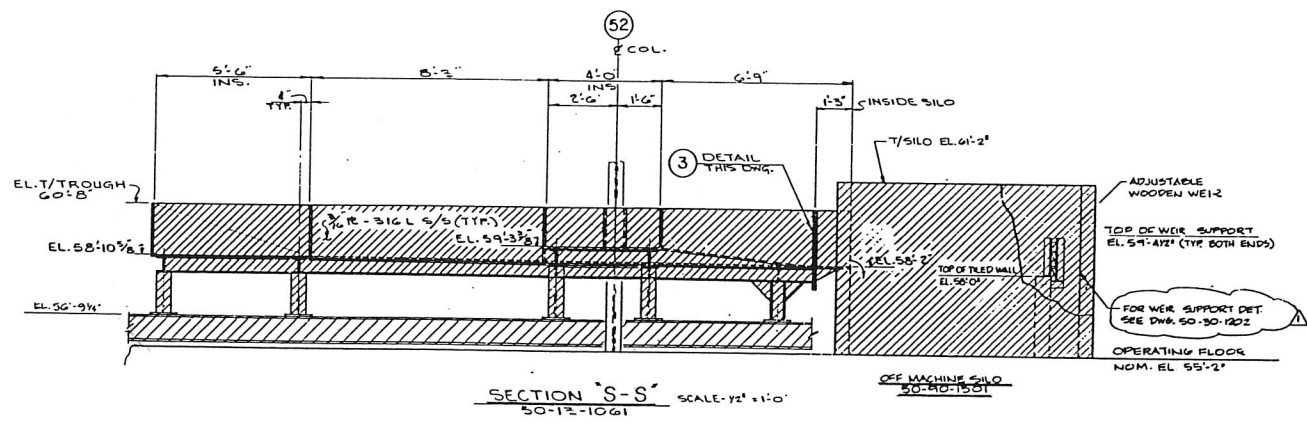
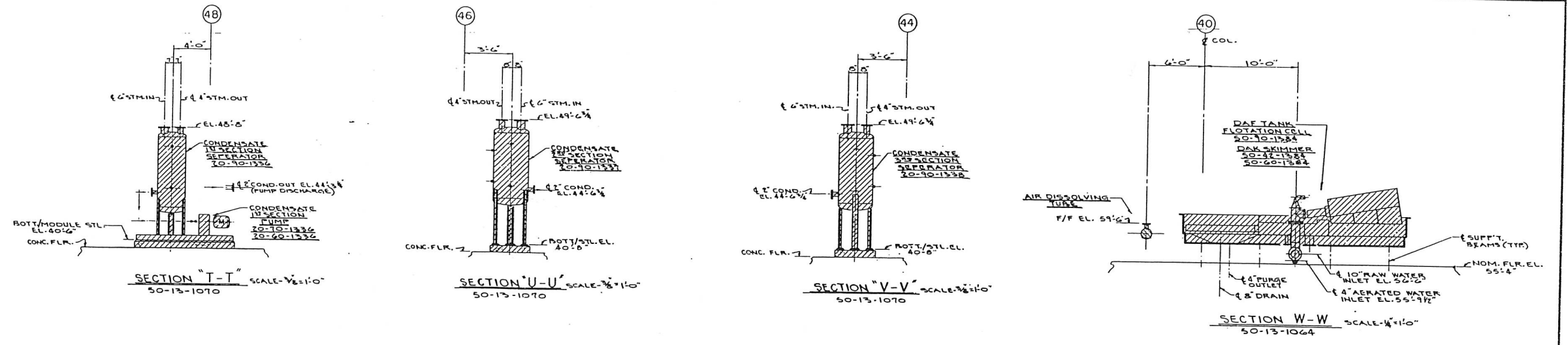

APPROVED FOR CONSTRUCTION

STONE CONTAINER CORPORATION UNCASVILLE, CONNECTICUT UNCASVILLE MODERNIZATION-1988										APPROVED DATE 2/2/78 PROJECT NO. 7641		SCALE 1/4"=1'-0" SHEET 11 OF 11		MACHINE ROOM GENERAL ARRANGEMENT SECTIONS	
SANDWELL SWAN WOOSTER INCORPORATED										RELEASED FOR DESIGN		DWG. 50-13-1084		REV. Δ	
A RELEASED FOR APPROVAL										DATE 1/1/78		DATE 1/1/78		DATE 1/1/78	