

BENNINGTON

BOATING BASICS & SAFETY

OWNER'S MANUAL

FUEL SYSTEMS

Boats manufactured for use in California for model year 2018 and after meet the California EVAP Emissions regulation for spark-ignition marine watercraft. Boats meeting this requirement will have the following label affixed near the helm.

WARNING

Operating, servicing and maintaining a recreational marine vessel can expose you to chemicals including engine exhaust, carbon monoxide, phthalates and lead, which are known to the State of California to cause cancer and birth defects or other reproductive harm. To minimize exposure, avoid breathing exhaust, service your vessel in a well-ventilated area and wear gloves or wash your hands frequently when servicing this vessel. For more information go to: www.P65warnings.ca.gov/marine

The fuel system in boats marketed in states other than California complies with U.S. EPA-mandated evaporative emission standards at time of manufacture using certified components.

CALIFORNIA AIR RESOURCES BOARD (CARB)

Outboard, sterndrive and inboard powered boats sold in the state of California are equipped with special components and certified to meet stricter environmental standards and exhaust emissions. All boats sold in California since 2009 are required to meet Super-Ultra-Low (four-star) emissions.

EXHAUST EMISSIONS



Sterndrive and inboard marine engine powered boats meeting CARB's exhaust emission standards are required to display the four-star label on the outside of the hull above the waterline. Outboard and personal watercraft marine engines may also comply with these standards.

DANGER

Carbon monoxide (CO) can cause brain damage or death. Engine and generator exhaust contains odorless and colorless carbon monoxide gas. Carbon monoxide will be around the back of the boat when engines or generators are running. Signs of carbon monoxide poisoning include nausea, headache, dizziness, drowsiness and lack of consciousness. Get fresh air if anyone shows signs of carbon monoxide poisoning. See engine manufacturer's manual for information regarding carbon monoxide poisoning.

TABLE OF CONTENTS

Introduction	1-1
Congratulations	1-1
About This Manual	1-1
About Your New Boat.	1-2
Boat Terminology	1-2
Hull Identification, Capacity and Safety Plates	1-2
Design Category	1-4
Disclaimer	1-4
References and Contact Information	1-5
Bennington Limited Warranty	1-8
California Evaporative Emissions Control System Warranty Statement	1-14
Your Warranty Rights and Obligations	1-14
Boat Information Form	1-16
Safety	2-1
Good Boating Practices	2-1
Safety Decals and Statements	2-4
Safety Decals	2-4
Safety Statements	2-8
Safety Precautions	2-9
Carbon Monoxide (CO)	2-13
Required Boating Safety Equipment and Regulations.	2-15
Fire Extinguisher	2-17
Engine Emergency Stop Switch and Lanyard	2-17
Life Jackets	2-18
Visual Distress Signaling Devices	2-21
Audible Signaling Devices	2-23
Navigational Lights	2-23
LED Lighting	2-24
Recommended Safety Equipment	2-25
Safety and Training	2-26
Situational Awareness	2-26
Driving Defensively	2-26
Small Boats and Swimmers	2-27
Knowing the Boat	2-27
Special Needs Passengers	2-27



TABLE OF CONTENTS

Very High Frequency (VHF) Radio	2-29
Cruising Limitations	2-30
Hazard Information	2-30
Water Sports	2-31
Platform Dragging.	2-31
Water Sports Guidelines.	2-32
Re-boarding – 2020 Model Year	2-35
Boating Regulations and Your Responsibilities	3-1
Boat Owner / Operator Responsibilities	3-1
Safety.	3-1
Registration	3-2
Insurance	3-2
Reporting Accidents	3-2
Boating Under the Influence	3-3
Operator’s License and Education	3-3
Operation By Minors	3-3
Emergency Assistance	3-4
Negligent Operation.	3-4
Restricted Areas	3-5
Security Zones	3-5
Naval Vessel Protection Zones.	3-5
Commercial Shipping Safety Zones.	3-5
Bridges and Shipping Channels.	3-5
America’s Waterway Watch	3-6
Fishing	3-6
Monofilament Fishing Line.	3-7
Wake	3-7
Noise	3-7
Speed.	3-7
Protecting the Environment	3-8
MARPOL Treaty	3-9
Aquatic Invasive Species (AIS)	3-9
Paints	3-10
Cleaning Agents	3-10
Exhaust Emissions	3-11
Additional Proposition 65 Information	3-11



Emergencies	4-1
First Aid / Medical Emergencies	4-1
Emergency Preparation Checklist	4-1
Using Distress Signal Devices and Calling for Help	4-1
Requesting Assistance (Non-Distress Call)	4-2
Law of Salvage	4-3
Fire and Explosion	4-3
Man Overboard (MOB)	4-4
Capsizing and Flooding	4-5
Running Aground	4-6
Dangerous Weather	4-6
Engine or Boat System Failure	4-6
Accidents, Collisions and Giving Assistance	4-7
Towing on the Water	4-7
Hurricane and Severe Weather Preparedness	4-9
Protecting the Boat from Theft	4-9
Operating in Hazardous Conditions	5-1
Severe Weather	5-1
Storm Conditions	5-1
Fog Conditions	5-2
Reduced Visibility	5-2
Cold Weather and Cold or Frozen Water Conditions	5-2
Water Hazards	5-2
Aquatic Vegetation/Weeds	5-3
Dams and Spillways	5-3
Shallow Water Operation	5-3
Markers, Warnings and Advisories	5-4
Boat Flags	5-4
Harbor Flags and Indicators	5-5
Navigation Rules and Aids	6-1
Right-of-Way	6-1
The General Prudential Rule	6-1
Navigational Lights and Night Operation	6-2
Audible Signals	6-4
Overtaking / Passing	6-5



TABLE OF CONTENTS

Meeting Head-On	6-6
Crossing.....	6-7
Aids to Navigation	6-8
Buoys	6-8
Mooring Buoys	6-9
Daymarks / Dayboards.....	6-9
Lights and Lighted Structures	6-10
Markers.....	6-11
Operating the Boat.....	7-1
Before Getting Underway	7-1
Safety Equipment.....	7-1
Float Plan	7-1
Pre-Departure Safety Checklist	7-2
Boarding	7-3
Boat Loading	7-3
Fueling	7-5
Fuel Management.....	7-5
Fuel Suppliers.....	7-5
Static Electricity and the Fuel System	7-5
Fuel (Gasoline)	7-6
Before Refueling.....	7-8
Fueling	7-8
Refueling Built-In Fuel Tanks	7-9
After Refueling	7-9
Outboard Engine Fueling Considerations.....	7-9
Getting Underway	7-10
Starting	7-10
Steering	7-11
Stopping	7-12
Shifting	7-13
Accelerating and Running Underway.....	7-14
Checks During and After Operation	7-16
Power Trim and Tilt.....	7-16
Power Trim	7-16
Performance Operation	7-19
Docking.....	7-19
Mooring	7-21



Anchors and Anchoring	7-21
Lines and Knots	7-23
Trailer and Launching	8-1
Legal Considerations	8-1
Trailer Classification	8-1
Trailer Type	8-1
Trailer Gross Vehicle Weight Rating	8-2
Towing Vehicle	8-2
Vehicle Towing Hitch	8-2
Hitch Ball and Trailer Coupler	8-3
Safety Chains	8-4
Trailer Brakes	8-5
5-Pin Wiring Connector	8-5
Trailer Guidelines	8-6
Backing Up	8-9
Launching	8-9
Loading Guidelines	8-11
Reporting Safety Defects	8-12
Boat Features and Options	9-1
Fuel System	9-1
Engine Lubrication System	9-1
Engine Cooling System	9-2
Steering System	9-2
Shift and Throttle Controls	9-4
Single-Lever Controls - Single or Twin Engine	9-4
Control Operation Guidelines	9-5
Electrical System	9-6
DC System	9-6
Propellers	9-7
Propeller Selection and Replacement	
Guidelines	9-8
Dual-Prop Drives	9-8
Gauges / Instruments	9-9
Multi-Gauges	9-9
Tachometer	9-9
Speedometer	9-10
Fuel Level Gauge	9-10



TABLE OF CONTENTS

Engine Water Pressure Gauge	9-10
Power Trim / Tilt Gauge	9-11
Voltmeter	9-11
Engine Water Temperature Gauge	9-11
Engine Hour Meter	9-12
Oil Level Gauge (Outboard Engine Oil Injection Optional).	9-12
Water Depth Gauge	9-12
Compass	9-12
Engine Warning Alarm System	9-12
Helm and Control Switches	9-13
Ignition Switch	9-13
Blower Switch.	9-13
Battery Switch	9-14
Engine Emergency Stop Switch and Lanyard.	9-15
Neutral Start Safety Switch (Start-in-Gear Prevention)	9-16
Horn Switch	9-16
Boarding and Courtesy Light Switches	9-16
Power Trim / Tilt Switch	9-16
Navigation Lights Switch	9-16
Symbols.	9-17
General Care and Maintenance	10-1
Engine	10-1
Fuel System	10-2
Carbon Canister System Direct Fill	10-3
Electrical System	10-13
Batteries	10-13
Circuit Breakers and Fuses	10-15
Galvanic Corrosion.	10-17
Saltwater Corrosion	10-17
Sacrificial Anodes.	10-18
Steering System.	10-21
Corrosion Protection	10-22
Hardware, Fasteners and Fittings.	10-22
Stainless Steel and Chrome Hardware.	10-22



Aluminum Hardware	10-23
General Maintenance and Cleaning	10-23
Marine Growth	10-23
Cleaning	10-24
Hull	10-24
Upholstery	10-25
Bimini Tops and Canvas Covers (Canvas)	10-26
Mooring and Trailering Covers	10-28
Carpet	10-29
Windshield	10-29
Window Channels	10-30
Teak	10-30
Bilge	10-31
Bilge Pump	10-31
Safety Equipment	10-32
General Boating Equipment	10-32
Trailer	10-33
Winterization and Storage	11-1
Winterization and Storage Preparation	11-1
Storing on a Cradle or Blocks	11-2
Storing on a Trailer	11-3
Recommissioning After Storage	11-3
Lifting – 2020 Model Year	
Lift Systems: ABYC H40.8	11-5
Stern	11-6
Troubleshooting	12-1
Glossary of Nautical Terms	13-1
Index	I-1



TABLE OF CONTENTS

This Page Intentionally Left Blank

Section 1

INTRODUCTION

CONGRATULATIONS

Congratulations and welcome aboard! To ensure each boating experience is a safe and enjoyable one, please read all the literature provided with your newly purchased boat carefully before operating the boat or any equipment.

Please keep this manual on board for future reference and pass all information along to the new owner if you ever decide to sell the boat.

ABOUT THIS MANUAL

This manual has been written as a general guide to safe operating practices, boating regulations and maintenance techniques for recreational boating. If this is your first time owning or operating a boat, it is recommended that you contact the boat dealer or local boating agency to find out how to enroll in a boater safety course prior to operating the boat.

This manual is not intended to be used as a replacement for specific information and procedures covered in manuals provided by the manufacturer of the engine, accessories and other major equipment. The owner's packet contains specific manufacturer's information on boat care, engine, audio system, steering system, etc.

Because we are constantly working toward product improvement, this manual is intended to be a general guide only. The illustrations used in this manual may not match the equipment on the boat; they are intended only as general reference views.

This information is supplied with the understanding that the boat will be operated with good seamanship and attention to safe loading, safe operating conditions and safe speed. The manner in which the boat is loaded and operated is the responsibility of the operator.



ABOUT YOUR NEW BOAT

BOAT TERMINOLOGY

It is important that you understand, learn and use appropriate and common nautical terminology while boating to ensure operator safety and the safety of others.

See the *Glossary of Nautical Terms* section of this manual for additional boating terminology.

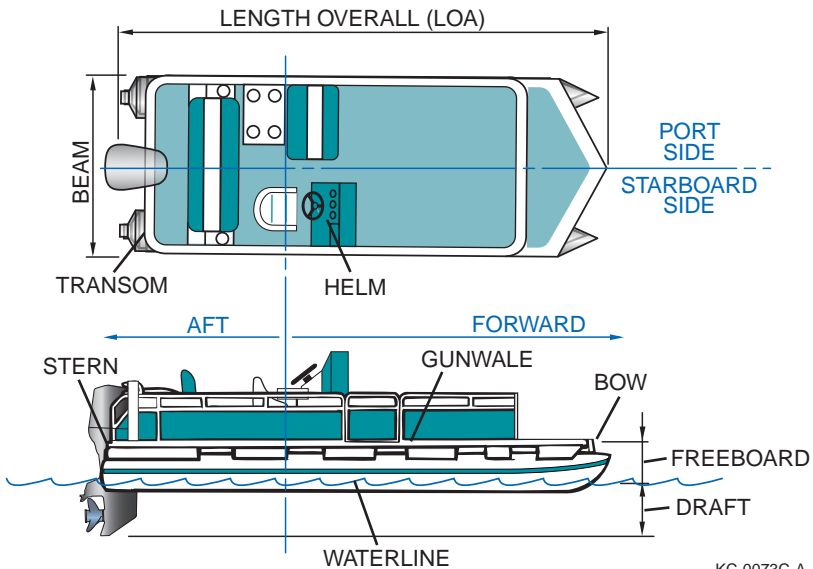

HULL IDENTIFICATION, CAPACITY AND SAFETY PLATES

Hull Identification Number

The hull identification number (HIN) is usually located near the upper starboard corner of the transom on the outside of the boat. In some instances, the HIN may be located in an alternate location as determined by the manufacturer (e.g., a pontoon HIN may be located on the aft crossmember approximately 1 foot (0.3 meters) from the starboard hull attachment). The HIN must be clearly visible and may not be removed, altered or tampered with in any way as regulated by federal law.



In case of collision, theft or damage, report these numbers to the local authorities, the insurance agent and the dealer.

Safeguard information about the boat by recording the HIN and model of the boat, and model and serial numbers of the engine and accessories on the Boat Information Form in this manual.

U.S. Coast Guard Safety Standards Compliance Plate

All power boats less than 20 feet (6 meters) must have a manufacturer's compliance plate clearly indicating that the boat is in compliance with the U.S. Coast Guard (USCG) safety standards and the effective date of the compliance. The compliance plate may be combined onto one plate showing both the capacity plate and compliance information by the manufacturer.

As a division of the U.S. Department of Homeland Security, the USCG is the ultimate authority on U.S. waters. The USCG has the right to board any boat for any reason at any time. Failure to obey an order from the USCG can result in a fine, confiscation, imprisonment and even being fired upon in certain areas or conditions.

Certification Standards

The boat was built to meet federal USCG requirements and *may* be certified to more stringent American Boat & Yacht Council (ABYC) standards for the fuel, electrical, ventilation, flotation, horn, identification, capacity, placards and labels, powering, start-in-gear protection, navigation lights, backfire flame control and in most cases, fire extinguishers.

The boat owner is responsible for other USCG-required safety items, which can vary depending on the size of the boat as follows:

- Fire Extinguishers
- Life Jackets
- Visual Distress Signals

The boat manufacturer or dealer may provide some required safety items. Your boat *may not* be certified to ABYC standards; check the capacity plate for more information.



The person/load capacity is determined by the USCG. The capacity plate is usually located within clear visibility of the boat operator or helm area. The capacity plate indicates limits for loading the boat, which are enforceable by law. Never exceed the “U.S. Coast Guard Maximum Capacities” indicated on the capacity plate.

Boats in the National Marine Manufacturers Association (NMMA) Certification program up to 26 feet (7.9 meters), or a pontoon boat of any length, are certified to ABYC standards, have the USCG maximum rated load capacity on the certification plate and may contain EPA and/or CARB emission information. Do not exceed maximum person or weight capacities.



KCB-0008

DESIGN CATEGORY

Pontoon boats are designed for casual cruising in calm conditions in sheltered waters; Category D. Wave heights over 1 foot (0.3 m) make pontoon boating uncomfortable. Waves over 2 feet (0.6 m) can be dangerous and should be avoided.

If you use your pontoon in the Great Lakes or ocean, you should confine your cruising primarily to bays and inlets and constantly monitor the weather for changes. A pontoon is not made to be an oceangoing craft and as such can only be used if the water conditions are similar to an inland lake and only close to shore.

DISCLAIMER

This Owner's Manual is provided for information and educational purposes only and is not intended to offer or provide legal advice or create a contractual relationship. Please be aware that as a boat owner, you have responsibilities regarding the safety, maintenance, fitness and operation of the boat which cannot be delegated to anyone else. The extent of such responsibilities is ultimately determined by Federal law and regulations, the general maritime law of the United States, the laws and regulations of the states and territories of the United States, or the laws and regulations of the country where you operate the boat.



REFERENCES AND CONTACT INFORMATION

Use the following list of publications and organizations for reference and contact information concerning safe boating, navigational rules and other boating topics.

Publications

- Bottomley, Tom. *Boatman's Handbook*. Hearst Marine Book. Morrow
- Brotherton, Miner. *Twelve Volt Bible*. Seven Seas
- Calder, Nigel. *Boatowner's Mechanical and Electrical Manual*. McGraw-Hill Education
- Chapman, Charles F. and Maloney, E.S. *Chapman's Piloting, Seamanship and Small Boat Handling*. Hearst Marine Book. Morrow
- Hinz, Earl. *The Complete Book of Anchoring and Mooring*. Cornell Maritime Press
- National Fire Protection Association. *NFPA 302 Fire Protection Standard for Pleasure and Commercial Motor Craft*. National Fire Protection Association
- United States Coast Guard. *Navigational Rules for U.S. Waterways*. Visit <https://www.navcen.uscg.gov/> to view or download this publication.
- United States Coast Guard Auxiliary. *Boating Skills and Seamanship Thirteenth Edition*. United States Coast Guard
- Whiting, John and Bottomley, Tom. *Chapman's Log and Owner's Manual*. Hearst Marine Book

Organizations

American Boat & Yacht Council

Boat building standards.
<http://abycinc.org>

American Red Cross

A resource for first aid training, emergency supplies and preparedness.
<http://www.redcross.org> or consult the local telephone directory

Boat Owners Association of The United States

Organization of recreational boaters offering marine services, education and protecting boater's rights.
<http://www.boatus.com/>

***BoatU.S. Foundation for Boating Safety Hotline***

Training and education outreach directly to boaters.

<http://www.boatus.org/>

Phone: 800-245-2628

National Association of State Boating Law Administrators

Boat safety training and education resources.

<http://www.nasbla.org>

National Marine Manufacturers Association

Boat, marine engine and accessory manufacturer trade association.

<http://www.nmma.org>

National Oceanic and Atmospheric Administration's National Weather Service

Nautical charting, weather, fishery, ocean and climate resources.

<http://www.noaa.gov>

National Safe Boating Council, Inc.

<http://www.safeboatingcouncil.org>

Sea Tow Services International, Inc.

Organization of recreational boaters offering in-water services, education and emergency assistance.

<http://www.seatow.com>

Toll free: 800-473-2869

U.S. Coast Guard

<http://www.uscgboating.org> (To contact the U.S. Coast Guard for an emergency while on the water, always use the onboard VHF-FM radio channel 16. Use cell phones only as a secondary means of communication. Call 9-1-1 to reach rescue personnel.)

U.S. Coast Guard Auxiliary

Information on boating safety classes and boat safety checks.

<http://nws.cgaux.org>; Phone: 877-875-6296

U.S. Coast Guard Navigation Center (NAVCEN)

USCG navigation information.

<https://www.navcen.uscg.gov>

***U.S. Coast Guard Office of Boating Safety***

USCG resources for recreational boaters.
<http://www.uscgboating.org>

U.S. Coast Guard's America's Waterway Watch Program

<http://www.americaswaterwaywatch.uscg.mil> (A program for recreational boaters to assist the U.S. Department of Homeland Security in reporting suspicious activity on U.S. waterways); Phone: 877-249-2824

U.S. Government Publishing Office

<http://www.gpo.gov>
(For information and documentation on FCC rules and regulations and Skippers Course information, and other government, marine and nautical related documents)

U.S. Power Squadrons

Boating courses and knowledge resources.
<http://www.usps.org>; Phone: 888-367-8777

Water Sports Industry Association

Water sports education, safety and risk management.
<http://www.wsia.net>



BENNINGTON LIMITED WARRANTY

North American Limited Product Warranty (Excludes Overseas, Commercial, and Rental Applications)

- 1. WHO WARRANTS THE WARRANTY.** The boat as described and limited herein has its product warranty extended by the manufacturer and installer of the boats manufactured by Pontoon Boat, LLC 2805 Decio Drive, Elkhart, an Indiana corporation, hereinafter referred to as Bennington.
- 2. WHO IS COVERED.** The warrantor, Bennington, warrants coverage for private, non-commercial, normal use. See details regarding transferability below. Any product used for commercial purposes, including, but not limited to rental fleets, demonstrators, competitive racing and other commercial uses shall have a one (1) year limited warranty for material and workmanship defects after the original invoice date to the Bennington dealer. This one year period will apply the same terms and conditions as are otherwise set forth herein except for length of time.
- 3. WHAT IS COVERED.** Bennington, your warrantor extends the following limited warranty to you, which limited warranty covers your Bennington pontoon as to material defects and all materials and workmanship supplied by or performed by Bennington.
- 4. WARRANTY PERIOD.** The Bennington limited warranty is expressed as follows, except for and subject to other coverages and conditions listed in the limited warranty. **Limited lifetime structural warranty and wood component warranty.** Bennington provides a limited warranty against structural failure on all pontoons, gates, channels, motor mounts or railings resulting from defects in material and or workmanship under normal non-commercial use. Additionally, Bennington will, at its discretion, repair or replace any wooden deck or wood component which fails as a result of defects in material and or workmanship free of charge for materials and labor to the original owner/retail purchaser only. **Transferability** - the **Limited lifetime structural warranty and wood component warranty** is transferable within ten (10) years of the original purchase date of the boat. Once transferred, coverage extends for a maximum of ten (10) years from date of original purchase. Completion of a warranty transfer is required through an authorized Bennington dealer.

The warranties listed below are transferable during the warranty period. A warranty transfer is required through an authorized Bennington dealer. **The original retail purchasers of 2017 and newer product are entitled to Ten (10) years of stem to stern coverage. In the event a qualifying Bennington product changes ownership a warranty transfer is required. If a warranty transfer occurs within ten (10) years, the remaining balance of the Ten (10) year stem to stern warranty will apply.**



Ten (10) year limited deck covering and fabric warranty. Warranted from failure due to fading, peeling or cracking for a period of Ten (10) years warranty shall include replacement materials and or labor, based upon an inspection by a qualified Bennington representative. Excessive deterioration caused by overexposure to the elements as a result of improperly covering the boat may be excluded from this warranty. Damage resulting in rips, tears, snags and unraveling or other abuse is not covered under this warranty.

Ten (10) year limited Bimini Top fabric warranty. Warranted against excessive loss of color or strength under normal exposure conditions.

Ten (10) year component parts warranty. Including radios, gauges and depth finders not manufactured by Bennington.

Ten (10) year warranty on all other items not specifically addressed above.

5. **OTHER WARRANTIES THAT MAY APPLY.** Additional component warranties may be provided by the respective manufacturers directly and not by Bennington. Applicable warranties may be found in the product owner's packet or by contacting Bennington's Customer Service Department. Bennington will not pay for or honor any such warranty of these separate manufacturers whether or not they honor such warranty.
6. **OWNER'S RESPONSIBILITY.** The original owner is required to register this product **within fifteen (15) days of delivery** of the boat by mail or through an authorized Bennington Sales Center. Owner must provide proof of purchase, including date of purchase, name of retailing dealer, boat serial number, and current proof of ownership at time of warranty claim. Proper maintenance and cleaning of the Bennington products and components are the responsibility of the owner. Failure of any product or component caused by improper cleaning procedures, negligence or faulty maintenance procedures is expressly excluded from the warranty. Proper boat registration in compliance with state and federal regulations and the purchase of insurance is the responsibility of the owner.
7. **HOW TO GET LIMITED WARRANTY SERVICE.** To obtain warranty service, take your boat to the marine dealer where you originally purchased your product, or other authorized Bennington dealer, or another warranty service facility designated by Bennington, and have a warranty claim submitted to Bennington. If you or your dealer has moved, or if your dealer is no longer in business contact Bennington Customer Service, 2805 Decio Drive, Elkhart, Indiana 46514, for the name of your nearest Bennington dealer. Your claim must be made within thirty (30) days of the discovery of the defect. Based on the determination of Bennington, and subject to the terms of the warranty, the warranty repair work will be authorized by Bennington.



8. **WHO PERFORMS LIMITED WARRANTY SERVICE.** The best place to obtain warranty service is at the Bennington dealer where you originally purchased your product. If the dealer cannot perform the service work they should call Bennington Customer Service for assistance. If you are unable to visit your original marine dealer, contact Bennington Customer Service, 2805 Decio Drive, Elkhart, Indiana 46514, for the name and location of a Bennington dealer near you.

In some instances, Bennington may require that the boat or certain parts be returned to the Bennington manufacturing facility for warranty service. Costs incurred for transporting the boat or parts to and from Bennington are the responsibilities of the owner.

9. **MODIFICATIONS OF PRODUCTS.** Bennington reserves the right to make changes in design of its products, and changes or improvements to its products, at any time, including during a product year, without imposing any obligation upon Bennington to alter any of its products that were previously manufactured.
10. **EXCLUSIONS AND LIMITATIONS.** Certain matters, issues and items are not covered by this limited warranty and are expressly limited herein, as follows: Damage caused by abuse, misuse, unreasonable use, neglect of others, failure to observe proper maintenance and operating practices, excessive speed for configuration or conditions, failure to comply to the safety regulations listed in your operators manual, failure to trim boat properly, improper or prolonged storage, submersion in water (under certain circumstances, water can roll over the front deck [bow] of a pontoon boat and cause damage to the bow rails). Corrosion or cosmetic damage from saltwater, towing behind other boats, improper trailers or trailering, mold or mildew related damage, rot or deterioration, improper use or stress on components or parts, attempted disassembly without Bennington authorization, accidents, acid rain, natural disasters, acts of terrorism, acts of war, or acts of God, or normal wear and tear or fading of fabrics and deck coverings. Batteries, engines, props and outrives. Gelcoat crazing and osmotic blistering. Equipment and accessories added after original purchase. Any non-Bennington supplied products or accessories added or installed by anyone. Replacement parts provided under terms of the warranty will, at the discretion of Bennington, match original equipment, but no guarantee is made as to the ability to do so. When necessary, Bennington will substitute parts of comparable function or value. Bennington will not be responsible for any sums exceeding the cost of defective part or product.



This warranty does not cover any Bennington product that is damaged as a result of electrolysis, stray-current corrosion or galvanic corrosion, or any such corrosion that results from the lack of maintenance of, and/or use of incorrect sacrificial anodes. Corrosion can occur under many different circumstances both in and out of the water which would not be covered under this limited warranty. Electrolysis can cause severe structural damage to a boat and its accessories. To prevent corrosion, precautions should be taken including but not limited to: sacrificial anodes, anti-fouling paint, limited exposure in saltwater, trailers with plastic-tread bunks (do not use carpeted bunks). Fully wash the boat, tubes and cross members immediately after every usage in saltwater.

Warranty will not be extended to non-factory installed items, including, but not limited to, engines and the installation of its components or additional time for adjustments or final assembly for delivery. Bennington will not be responsible nor liable for warranty coverage from use of equipment that exceeds the manufacturing load capacities, certification or horse power for the product. Modifications, alterations, or repairs performed by unauthorized personnel may invalidate all or part of the Bennington warranty. Corrosion due to using non-marine grade screws and fasteners to add, replace, or repair any items will not be covered by warranty. Contact Bennington Customer Service before making any custom changes.

Bennington shall not be responsible nor liable for consequential indirect or incidental damages, mental anguish or distress, such as damage or injury to persons, loss of property, loss of time or inconvenience, loss of revenue, loss of use or enjoyment, towing expenses, haul out or launching expenses, de-rigging or re-rigging charges, gasoline, mileage, Bennington dealer or non-Bennington dealer service calls, charges, transportation, telephone, loading expenses or any similar cost not mentioned above. Damages are exclusively limited to the cost of repair and/or replacement of the damaged or defective part or parts, as the case may be, at the exclusive option of Bennington and Bennington shall not be responsible for any other damages whatsoever.



11. **LIMITS OF THE WARRANTY.** This written statement of limited warranty represents the entire warranty authorized and offered by Bennington which, pursuant to the terms of this limited warranty, is limited to repair or at the option of Bennington, replacement of parts or equipment that are determined by Bennington to be defective under the terms of this warranty. **TO THE GREATEST EXTENT PERMITTED BY LAW ALL OTHER WARRANTIES, INCLUDING ANY IMPLIED WARRANTIES, WARRANTIES OF MERCHANTABILITY AND WARRANTIES FOR A SPECIFIC PURPOSE ARE HEREBY EXPRESSLY EXCLUDED.** There are no warranties or representations beyond those expressed in this written document. This limited warranty cannot be amended by any dealership, salesperson or agent. No warranties are made on products sold outside the continental United States or Canada. **BENNINGTON SHALL NOT BE RESPONSIBLE NOR LIABLE FOR ANY INCIDENTAL, CONSEQUENTIAL, SPECIAL OR ANY OTHER DIRECT OR INDIRECT DAMAGES (INCLUDING BUT NOT LIMITED TO, LOST PROFITS, LOST SALES, LOSS OF TIME, BOAT PAYMENTS, INTEREST, STORAGE AND SLIP FEES, INSURANCE, POSTAGE, AFTERMARKET GOODS, DEPRECIATION OF VALUE DUE TO AGE OR REPAIRS CONDUCTED OR NEEDED, COURT COSTS AND EXPENSES, ATTORNEY FEES, INJURY TO PERSON OR PROPERTY. SOME STATES DO NOT ALLOW ONE OR MORE OF THESE LIMITATIONS, SO CERTAIN OF THE FOREGOING LIMITATIONS MAY NOT APPLY TO YOUR SPECIFIC SITUATION.**
12. **CHOICE OF LAW; JURISDICTION AND VENUE.** This warranty shall be governed exclusively by, and construed exclusively in accordance with, the internal laws of the State of Indiana without reference to the choice of law or conflict of law principles thereof, and all claims relating to or arising out of this warranty, or the breach thereof, whether sounding in contract, tort or otherwise, shall likewise be governed exclusively by the laws of the State of Indiana without reference to the choice of law or conflict of law principles thereof. To the extent any action is permitted in a court of competent jurisdiction, such action shall take place in the state or federal courts sitting in Elkhart County, Indiana, the parties hereby waiving any claim or defense that such forum is not convenient or proper. Each party agrees that any such court shall have *in personam* jurisdiction over it for any such action, and each party consents to service of process in any manner authorized by Indiana law.



- 13. DISPUTE RESOLUTION.** Should you be unable to resolve a disagreement with your service facility regarding warranty coverage for a needed repair, contact the Bennington Customer Service Department. Our customer service team will work with you and your dealer to complete needed repairs. If a dispute about warranty service arises between Bennington and you, the owner, a disagreement can be resolved in accordance with customary arbitration procedures agreed upon by both parties. Any and all legal remedies shall be available to the owner after pursuing this informal dispute resolution if a ruling is entered against Bennington and Bennington fails to abide by the ruling. The expenses of this arbitration will be paid by the party against whom the arbitrator(s) rule.
- 14. STATE and FEDERAL WARRANTY ENFORCEMENT LAWS.** This warranty gives you specific legal rights. You may also have other rights which vary from state to state. Some states may have laws which permit owners to obtain a replacement unit or a refund of the purchase price under certain circumstances. The provisions of these laws vary from state to state. To the extent allowed by state law, Bennington requires that you first provide us with written notification of any service difficulty you have experienced with the Bennington pontoon so that we have an opportunity to make any needed repairs, before you are eligible for the remedies provided by these laws. Your written notification should be sent to the Bennington Customer Service Manager at the address set out above. Always include your Hull Identification Number, found on the aft deck trim of the pontoon. To the extent any provisions of this limited warranty are inconsistent or deemed unenforceable with (or under) State or Federal laws, only those parts shall be deemed to be voided or limited to the extent required to comply with the law at issue.
- 15. FEDERAL COMPLIANCE.** The terms of the warrantors undertaking expressed in this limited warranty are drafted to comply with the Magnuson Moss Warranty Legislation, P.L. 93-637 of 1974, and other applicable law. Any warranty provisions promulgated by the Federal Trade Commission pursuant to rules or any other law relative thereto are expressly incorporated herein.



CALIFORNIA EVAPORATIVE EMISSIONS CONTROL SYSTEM WARRANTY STATEMENT

YOUR WARRANTY RIGHTS AND OBLIGATIONS

The California Air Resources Board and Pontoon Boat, LLC is pleased to explain the evaporative emission control system's warranty on your 2020 boat. In California, new spark-ignition marine watercraft (SIMW) must be designed, built, and equipped to meet the State's stringent anti-smog standards. Pontoon Boat, LLC must warrant the evaporative emission control system on your boat for the period listed below provided there has been no abuse, neglect or improper maintenance of your SIMW.

Your evaporative emission control system may include parts such as: canisters, carburetors, clamps, connectors, filters, fuel caps, fuel lines, fuel tanks, valves, vapor hoses, and other associated evaporative emissions control system components.

MANUFACTURER'S WARRANTY COVERAGE:

This evaporative emission control system is warranted for two years. If any evaporative emission-related part on your SIMW is defective, the part will be repaired or replaced by Pontoon Boat, LLC.

OWNER'S WARRANTY RESPONSIBILITIES:

- As the boat owner, you are responsible for performance of the required maintenance listed in your owner's manual. Pontoon Boat, LLC recommends that you retain all receipts covering maintenance on your boat, but Pontoon Boat, LLC cannot deny warranty solely for the lack of receipts.
- As the boat owner, you should however be aware that the Pontoon Boat, LLC may deny you warranty coverage if your spark-ignition marine watercraft or a part has failed due to abuse, neglect, or improper maintenance or unapproved modifications.
- You are responsible for presenting your boat to a Pontoon Boat, LLC distribution center or service center as soon as the problem exists. The warranty repairs should be completed in a reasonable amount of time, not to exceed 30 days. If you have a question regarding your warranty coverage, you should contact Mike Robinson at 1-888-906-2628.



The California evaporative emissions control system warranty covers the following list of components:

- | | |
|-------------------------------------|--|
| (1) Canister Mounting Brackets | (11) Fuel Line |
| (2) Carbon Canister | (12) Fuel Line Fittings |
| (3) Carburetor Purge Port Connector | (13) Fuel Tank |
| (4) Clamps* | (14) Liquid/Vapor Separator |
| (5) Control Cables* | (15) Pressure Relief Valves* |
| (6) Control Linkages* | (16) Purge Valves |
| (7) Control Solenoids* | (17) Vacuum Control Diaphragms* |
| (8) Control Valves* | (18) Vapor Hoses |
| (9) Electronic Controls* | (19) All other parts not listed that may affect the evaporative emissions control system |
| (10) Fuel Cap | |

* NOTE — As they relate to the evaporative emissions control system.

**BOAT INFORMATION FORM**

BOAT	
Boat Manufacturer:	
Hull Colors:	
Weight:	
Length:	
Draft:	
Beam:	
Vertical Clearance:	
Dealer:	
Dealer Representative:	
Dealer Phone:	
Boat Model:	
Hull ID Number (HIN):	
Registration Number:	
Registration State:	
Purchase Date:	
Delivery Date:	
Warranty Expiration Date:	
Manufacturer Representative:	
Manufacturer Phone:	
ENGINE, DRIVE AND PROPELLER	
Engine Make:	
Engine Model Number:	
Engine Serial Number:	
Hours:	
Ignition Key Number:	
Drive Make:	
Drive Model Number:	
Drive Serial Number:	
Propeller	Make/Type:
	Size/Material:
	Part Number:



SYSTEMS	
Fuel Filter Part Number:	
Battery Make:	
Battery Size:	
TRAILER	
Trailer	Make:
	Model Number:
	Serial Number:
	GVWR:
	Tire Size:
ACCESSORIES	
Manufacturer:	
Model:	
Serial Number:	
Manufacturer:	
Model:	
Serial Number:	
Manufacturer:	
Model:	
Serial Number:	
Manufacturer:	
Model:	
Serial Number:	



SECTION

1

INTRODUCTION

This Page Intentionally Left Blank

Section 2

SAFETY

The popularity of boating and other water sports has undergone an explosion of growth in the past few years, making safety an important issue for everyone who shares in the use of the waterways.



WARNING

Operation Hazard: Read and understand this Basic Boating and Safety Manual, the Engine Operator's Manual and all manufacturer-supplied information regarding the operation of equipment. The boat operator must understand all safety information responsibilities, regulations, controls and operating instructions before attempting to operate the boat. Improper operation could result in death or serious injury.

The safety content and precautions listed in this manual and on the boat are not all-inclusive. If a procedure, method, tool or part is not specifically recommended, the operator must feel confident that it is safe for them and others, and that the boat will not be damaged or become unsafe as a result of the operator's decision.

REMEMBER – ALWAYS ASSESS EACH SITUATION AND USE SOUND JUDGMENT!

The boat operator is responsible for their own safety, as well as that of passengers and other boaters.

GOOD BOATING PRACTICES

Boating-related accidents are generally caused by the operator's failure to follow basic safety rules or written precautions. Most accidents can be avoided if the operator is completely familiar with the boat, its operation and the navigational rules of the road and can recognize potentially hazardous situations.

In addition to everyday safety, failure to observe safety recommendations may result in severe personal injury or death to the operator or to others. Use caution and sound judgment when operating the boat. Do not take unnecessary chances! Failure to adhere to these warnings could result in death or severe injury to the operator and/or others.



Read this entire manual and be aware of other specific safety guidelines not listed in this manual. Seek additional safety information from the USCG and state and local authorities. In addition to specific safety statements noted in this manual, a general list of safety guidelines and recommendations is listed below:

- The boat must comply with USCG safety equipment regulations.
- Before each outing, check all safety equipment such as fire extinguishers, life jackets, flares, distress flags, flashlights and engine emergency stop switch. Make sure they are operable, in good condition, readily visible and easily accessed.
- Onboard equipment must always conform to the governing federal, state and local regulations.
- Never allow any type of spark or open flame on board. It may result in fire or explosion.
- Take the keys/FOBs when leaving the boat to keep untrained and unauthorized persons from operating the boat.
- Know how to react correctly to adverse weather conditions, have good navigation skills and follow navigational rules as defined by USCG, state and local regulations.
- Check local weather reports before casting off. Do not leave the dock area when strong winds and electrical storms are in the area or predicted to be in the area.
- Seek shelter from open water if lightning is an imminent threat.
- Tell someone of the travel plans before departing.
- Know the weight capacity of the boat. Never overload the boat.
- Never operate the boat while under the influence of drugs or alcohol.
- Look before turning the boat. The boater is obligated to maintain a course and speed unless it is safe to alter course and speed. Look before turning.
- Operators must read and understand all operating manuals supplied with the boat before operation.
- Whenever planning an outing, make sure that at least one passenger is familiar with the operation and safety aspects of the boat in case of emergency.
- Passengers should never sit in front of the operator; always avoid obstructing the operator's view.
- Show all passengers the location of emergency equipment and explain how to use it.
- Never allow passengers to drag their feet or hands in the water, or sit on the bow, bow pulpit, deck or gunwale while the engine is running.
- Never use or hold on to the boarding platform while the engine is running.
- Never stand or allow passengers to stand in the boat or sit on the transom, seat backs, engine cover or sides of the boat while the engine is running. The operator or others may be thrown from the boat.



- Children and nonswimmers must wear a life jacket at all times.
- Never leave children in the boat without adult supervision.
- Improper operation of the boat is extremely dangerous.
- Securely attach the engine emergency stop switch lanyard around your leg or to a part of your clothing such as a belt loop, when operating the boat. Instruct others on how to start the boat if you as an operator are thrown overboard. Consider having an extra lanyard readily available on board since the system cannot be overridden without the lanyard that is on the person who is now overboard.
- Operate slowly in congested areas such as marinas and mooring areas.
- The bow may be slippery. Do not go forward while the engine is running.
- Slow down when crossing waves or wake in order to minimize the impact on passengers and the boat.
- Never replace the boat's marine parts with automotive parts (if applicable).
- Never remove or modify any components of the fuel system. Always have qualified personnel perform fuel system maintenance. Tampering with fuel components may cause a hazardous condition.
- Avoid contact with engine exhaust gases—engine exhaust contains carbon monoxide.
- Never operate the engine in a confined space.
- Never go under the boat cover with the engine running or shortly after the engine has been running.
- Allow adequate ventilation with fresh air before entering any enclosed areas.
- Watch for other boats, swimmers and obstructions in the water. Stay away from other boats and personal watercraft (PWCs).
- Never swim near a boat when the engine is running. Even if the boat is in the NEUTRAL position, the propeller may still be turning and carbon monoxide may be present.
- Never dive from the boat without being absolutely sure of the depth of the water; severe injury or death may occur from striking the bottom or submerged objects.
- Never wrap ski lines or mooring lines around any body part. You could become entangled in the line if you fall overboard while the boat is moving.
- Keep track of ski lines and dock lines so they do not become entangled in the propeller.
- Have an experienced operator at the helm and always have at least three people present for safe towing—one to drive, one to observe, and one to ski or ride.



SAFETY DECALS AND STATEMENTS

SAFETY DECALS

The boat is affixed with various hazard and safety decals at the time of manufacture. These decals appear in specific locations on the boat and on equipment where safety is of particular concern. All operators of the boat must read and understand all hazard and safety decals and advise all passengers on the safety concerns and proper practices. Hazard and safety decals must remain legible. If the operator suspects a decal is missing or damaged they should contact the dealer for immediate replacement.

WARNING LABELS 2020			
APPLICATION	DWG #	LOCATION	LABEL DESCRIPTION
BOAT			
Helm		cap. chart in operators view	Cap tag
Helm	7271	in operators view	Limited visibility
Helm	7285	at shifter	Unintended acceleration
Helm	7303	in operators view	Boater check list
Helm	7295	in operators view	Negative trim
Helm	7272	in operators view	I/O blower warning label
Helm	7304	in operators view	CO warning, orange
Helm	7313	in operators view	EVAP 1, EVP 2, EVAP 3, EVAP 4
Helm	7306	in operators view, boats with sundeck	Do not use ladders and sundeck pads while engine is running
Helm	7305	back door of console door	Do not store fuel. Electronic instruments
Bow deck fishing seats	7294	on pedestal base	Bow deck fishing seat bases (seats outside the bow gate)
Bow fishing seats, recliners	7194	adjacent rail	Do not use fishing seats when underway
Gates	7254	top of all gates	Gate warning label



WARNING LABELS 2020

APPLICATION	DWG #	LOCATION	LABEL DESCRIPTION
BOAT			
Gate (bow)	7292	back side of front gate	Bow deck warning
26' LOA and bigger	7280	in owners packet	Oil discharge (in owners packet)
26' LOA and bigger	7278	in owners packet	Trash overboard (in owners packet)
Midship U-bolts	5647	no rail behind U-bolt	No lift
Welded on tube eyes	-	stamped on the eye	No lift
Sundeck pads	7306	stern walkway at sundeck	Do not use ladders and sundeck pads while engine is running
Swing back without stern rails	7290	stern walkway	Aft seats without stern rails
Hidden fire extinguisher	7284	on compartment	Fire extinguisher inside
Ski tow bar and steel pylons	7265	on bar of pylon	Not for parasail or water craft
Removable aluminum pylons	7323	on pylon 20" from bottom	Rotate, do not parasail
Stern "chain gate"	7253	stern walkway	Secure chain
Near aft ladder(s)	7195	top third of endcap(s)	Prop warning
Near aft ladder	7308	stern deck trim	CO warning, red, with pic of CO cloud at stern
Stern storage areas	7314	stern storage areas	Do not store fuel



WARNING LABELS 2020

WARNING LABELS 2020				
APPLICATION	DWG #	LOCATION	LABEL DESCRIPTION	
FUEL				
Fuel system (pressurized only)	7311	near fuel fill	Warning, fuel under pressure	
Fuel system	7309	near fuel fill	No E-15 fuel (near cap)	
Fuel system	7312	in compartment	Inspect fuel system annually (by fuel system)	
Fuel System	7307	in compartment	Ventilation not provided (compartments near stern where people may store portable fuel)	
Stern	7256	in compartment	Fuel vapors Gli Rli Sli and privacy of Fsi and GSI starting 2011.5	
CW lounge with fuel	7242	in bench	Do not store or install non-ignition protected (in lounge on aluminum plate)	
CANVAS				
Privacy	7200	in privacy	CO warning (in all privacies with or without canvas)	
Extruded bimini	-	sewn into canvas	30 MPH sewn into bimini canvas (was 15 mph from 1998 to 2018.5)	
Extruded bimini	7276	aft stbd bimini strut	30 MPH (cable exemption for 2020)	
12' Extruded bimini	7126	by snap on aft bimini frame P & S	Unsnap before closing	
Extruded double	7249	on forward main by attachment point P & S	Do not fold backwards (on double bimini frame)	
10' wide	7293	by pad eye on bimini frame P & S	Use straps	
Clad arch with draw latch till thru 2018	7321	arch stbd access panel	Inspect annually. Free replacement parts. Contact dealer	



WARNING LABELS 2020

APPLICATION	DWG #	LOCATION	LABEL DESCRIPTION
CANVAS			
ARCH manual style (with OEM warning label)	7275	on arch by latch P & S (SEI)	Manual lock and unlock
ARCH power style (with OEM warning label)	7315	on power arch by driver (SEI)	Use upright. Lubricate
Camper enclosure	7196	front curtain	CO (inside every camper enclosure front curtain)
Camper enclosure	7196	stbd curtain	CO (inside every camper enclosure stbd curtain near helm)
APPLIANCES			
Gas grill	7267	on handle of grill	Label cylinder storage (on handle of grill)
Gas grill	7266	on handle of grill	Label cylinder storage (on handle of grill)
Gas grill	7260	open flame	Open flame
Battery charger	7261	by plug	Label battery charger - GFCI (by plug) (or manufacturer's label if supplied) brf 4/4/19
Sink	7310	by sink	Non-potable (round label)



SAFETY STATEMENTS

There is no substitute for sound judgment and careful practices. Improper practices or carelessness can cause burns, cuts, mutilation, asphyxiation, other bodily injury or death. This information contains general safety precautions and guidelines that must be followed to reduce risk to personal safety. Special safety precautions are listed in specific procedures. Read and understand all of the safety precautions before operation or performing repairs or maintenance.



NOTE — This safety alert symbol appears with most safety statements. It means attention, become alert, your safety is involved! Please read and abide by the message that follows the safety alert symbol.



DANGER

Indicates a hazardous situation that, if not avoided, will result in death or serious injury.



WARNING

Indicates a hazardous situation that, if not avoided, could result in death or serious injury.



CAUTION

Indicates a hazardous situation that, if not avoided, could result in minor or moderate injury.

NOTICE

Indicates a situation that can cause damage to the boat and accessories and/or the environment, or cause the equipment to operate improperly.



SAFETY PRECAUTIONS



DANGER

The safety messages that follow have DANGER level hazards. These safety messages describe hazardous situations that, if not avoided, will result in death or serious injury.



Training Hazard: Do not permit anyone to launch, operate or retrieve the boat without proper training.

- Read and understand this Basic Boating and Safety Manual and all manufacturer-supplied information before operating or servicing the boat to ensure that you follow safe operating practices and maintenance procedures.
- Safety signs and decals are additional reminders for safe operating and maintenance techniques.
- See the boat dealer for additional training.



Exhaust Hazard: Carbon monoxide (CO) is a colorless and odorless gas produced by all engines, fuel-burning appliances and any material that contains carbon and is burned. Direct or prolonged exposure to carbon monoxide will cause brain damage or death.



Electrocution Hazard: Docks and other boats nearby can carry sources of electricity. Faulty wiring or the use of damaged electrical cords and other devices not approved as “shore or marine rated” can cause the surrounding water source to become energized from electricity leakage. Never enter the water or swim in a marina.



WARNING

The safety messages that follow have WARNING level hazards. These safety messages describe hazardous situations that, if not avoided, could result in death or serious injury.



Fire/Explosion Hazard: Gasoline is extremely flammable and highly explosive under certain conditions.

- Compartments for fuel, flammable liquids or gases must be properly ventilated to prevent explosive vapors from accumulating. Most vapors are heavier than air. If not in a vapor-tight locker vented overboard, vapors will accumulate in the bilge, posing a fire and explosion hazard.
- Inspect fuel system for leaks at least once a year.



Fire/Explosion Hazard: Hydrogen gases produced by a lead-acid battery while it is charging, or the engine is running, can cause an explosion and/or a fire.

- Always wear personal protective equipment when working on or around batteries.
- Keep the area around the battery well-ventilated.
- Do not smoke or bring an open flame or any other form of ignition near a battery.
- Do not check for a dead battery by placing a metal object between the battery posts. Sparks could cause an explosion.
- Do not place your head directly above a battery when making or breaking electrical connections.
- Always charge the battery outside of the boat.
- Do not use a battery booster to start the engine.



Sever Hazard: Make sure nobody is near the propeller before starting the engine(s).

- Do not allow swimmers to approach or use the ladder when the engine is running.
- The operator should walk to the stern and check the water for people near the propeller, as people in the water may not always be noticeable from the helm.
- Turn off the engine(s) before allowing people to board or exit the boat. The propeller may continue rotating even when the engine is idling or in NEUTRAL.
- Show passengers the location of the propeller and teach them to keep their distance from it at all times, even when the propeller is not in motion.
- Show passengers the propeller warning labels around the boat and discuss propeller dangers.
- Be particularly alert when boating in high-traffic areas and never operate in swimming zones.
- Exercise caution when operating near boats that are towing skiers and tubers.
- Never allow passengers to sit in areas where they could fall overboard, including the bow, gunwale, transom, seat backs, or other locations.



- **Carefully watch children aboard the boat at all times.**
- **Instruct passengers on the rules for using the swim platform, boarding ladders and seats. If possible, instruct them to stay seated at all times while the boat is underway.**



Man Overboard Hazard: Always remain seated in the boat manufacturer's designated seating arrangement, use handholds and never block the view of the boat operator while underway. The boat's bow, gunwale, transom platform and seat backs are not intended for use while underway.

- **If someone falls overboard, slowly turn the boat around while keeping an eye on the victim. Ask a passenger to help monitor the victim. Always STOP THE ENGINE before rescuing a victim from the water.**
- **Never put the engine in REVERSE to retrieve a person from the water. Slowly circle back to the person again if necessary.**



Entanglement Hazard: Rotating or moving parts can entangle or sever body parts.

- **Do not wear jewelry, unbuttoned cuffs, ties or loose-fitting clothing.**
- **Tie long hair back when working near moving or rotating parts such as the flywheel or propeller shaft.**
- **Keep hands, feet and tools away from all moving parts.**
- **Keep all guards in place when the engine is operating.**
- **Use caution when working with ski or mooring lines so they do not become entangled with the propeller.**



Exposure Hazard: Wear personal protective equipment, including appropriate clothing, gloves, work shoes, eye and hearing protection, as required by the current task.



Control Hazard: Do not operate the boat while you are under the influence of alcohol or drugs or if feeling ill. Federal laws prohibit operating a boat under the influence of alcohol or drugs. These laws are vigorously enforced.

**CAUTION**

The safety messages that follow have CAUTION level hazards. These safety messages describe hazardous situations that, if not avoided, could result in minor or moderate injury.



Slip/Trip Hazard: Keep the boat free of water, oil, mud and other foreign matter. Do not wax deck and swim platform surfaces. Remove anything that creates slippery areas around the boat.

NOTICE

The safety messages that follow have NOTICE level hazards. These messages are used to indicate a situation that can cause damage to the boat and accessories and/or the environment, or cause the equipment to operate improperly.

- *Unapproved modifications to the boat or systems may impair the boat's safety and performance characteristics and shorten the boat's life. Any alterations to the boat may void its warranty. Always consult the boat manufacturer before making modifications or adding equipment.*
- *ALWAYS be environmentally responsible. Follow the guidelines of the EPA or other governmental agencies for the proper disposal of hazardous materials such as engine oil and fuel. Consult the local authorities or reclamation facility.*



CARBON MONOXIDE (CO)



DANGER

Exhaust Hazard: CO gas is colorless, odorless and extremely dangerous. All engines and fuel-burning appliances produce CO as exhaust. Direct and prolonged exposure to CO will cause brain damage or death. Always avoid exposing your passengers or yourself to CO.



Even with the best boat design and construction, plus the utmost care in inspection, operation and maintenance, hazardous levels of CO may still be present in accommodation areas under certain conditions. To reduce CO accumulation, always provide adequate ventilation in the boat interior by opening the deck hatches, windows or canvas.

Do not confuse carbon monoxide poisoning with seasickness, intoxication or heat stress. If someone complains of irritated eyes, headache, nausea, weakness, dizziness or drowsiness, or you suspect carbon monoxide poisoning, immediately move the person to fresh air, investigate the cause and take corrective action. Seek medical attention if necessary.

Always use a CO detector in confined areas where there is a possibility of CO buildup, such as enclosed canvas, sleeping quarters, galleys and head compartments. Regularly check the condition of the CO detector for proper operation.

Make sure that all passengers know what the CO detector alarm sounds like. If the alarm sounds, shut down engines and generator, move passengers to fresh air for at least 10 minutes, reset the alarm and investigate the cause. Ventilate the space thoroughly before restarting engines and generator.

Test the carbon monoxide detector operation before each trip, at least once a week and after the boat has been in storage. Also have the CO detectors professionally tested at regular intervals. Most CO detectors are required to be replaced every 5 years – see the OEM manual.



Potential Causes of CO Poisoning While Underway

Blockage of boat exhaust by obstruction



Exhaust from other vessels in confined areas

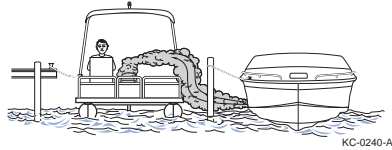

Operating at a high bow angle



Operating at slow speed or while idling



Exhaust traveling along obstruction



Operating with canvas tops and side curtains in place without ventilation



Always ensure adequate fresh air ventilation through the boat when underway.



KC-0300-B



REQUIRED BOATING SAFETY EQUIPMENT AND REGULATIONS

**U.S. Coast Guard Minimum Onboard Personal Safety Equipment Required
(Your boat may be equipped with one or more requirements by the manufacturer.)**

	LESS THAN 16 FT (4.9 M)	CLASS 1: 16 TO LESS THAN 26 FT (4.9 TO LESS THAN 7.9 M)	CLASS 2: 26 TO LESS THAN 40 FT (7.9 TO LESS THAN 12.2 M)	CLASS 3: 40 TO 65 FT (12.2 TO 19.8 M)
LIFE JACKETS AND PERSONAL FLOTATION DEVICES (PFDs)	One U.S. Coast Guard-approved Type I, II, III or V wearable life jacket for each person on board	One U.S. Coast Guard-approved Type I, II, III or V wearable life jacket for each person on board and one throwable Type IV PFD device		
VISUAL DISTRESS SIGNALING DEVICES	One (1) electric distress light OR three (3) day and night combination red flares	One orange distress flag or one electric distress light OR three floating or handheld orange smoke signals and one electric distress light OR three day and night combination red flares, handheld, parachute or meteor type		
AUDIBLE SIGNALING DEVICES	A boat less than 39.4 ft (12 m) must have on board an efficient sound-producing device. (Example: hand or mouth whistle OR a compressed or powered air horn)	A boat less than 39.4 ft (12 m) must have on board an efficient sound-producing device. (Example: hand or mouth whistle OR a compressed or powered air horn) A boat 39.4 ft (12 m) but less than 65.6 ft (20 m) in length operating in inland waterways must carry a power whistle OR powered air horn AND a bell		
NAVIGATION LIGHTS	Regulations require that navigational lights be clearly lit and properly displayed at all times between sunset and sunrise and always when operating in reduced visibility while boating			



	LESS THAN 16 FT (4.9 M)	CLASS 1: 16 TO LESS THAN 26 FT (4.9 TO LESS THAN 7.9 M)	CLASS 2: 26 TO LESS THAN 40 FT (7.9 TO LESS THAN 12.2 M)	CLASS 3: 40 TO 65 FT (12.2 TO 19.8 M)
FIRE EXTINGUISHERS	<p>One B-I type (U.S. Coast Guard-approved)</p> <p>If the boat meets any one or more of the following conditions, the boat must carry one B-I type USCG-approved extinguisher on board:</p> <ul style="list-style-type: none"> • Inboard/sterndrive engine powered • Has closed compartments where portable fuel tanks can be stored • Has double bottom construction that has areas where air or gases can be open or trapped • Has an enclosed living space • Has compartments where flammable, combustible or explosive materials are stored • Has permanent fuel tanks installed • Boat is 26 ft (7.9 m) or more in length 		<p>One B-II OR two B-I type (USCG-approved) (A fixed extinguishing system is equal to one B-I.)</p>	<p>One B-II AND one B-I OR three B-I type (USCG-approved) (A fixed extinguishing system is equal to one B-I OR two B-II.)</p>



FIRE EXTINGUISHER

USCG-approved fire extinguishers are required on all Class I, II and III boats. Mount all handheld fire extinguishers in readily accessible areas away from the engine compartment and other combustible devices. All passengers must know the location and operating procedure of each extinguisher. Follow the manufacturer's instructions for proper use and operation of the fire extinguisher.

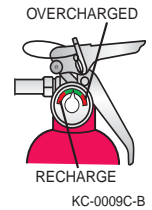

All fire extinguishers used on marine boats must be classified to extinguish type B fires (gasoline, oil or grease). The size and number of required fire extinguishers depend on the size of the boat. The two type B fire extinguishers commonly used are B-I and B-II. Type B fire extinguishers are classified by the different extinguishing compound amounts used in each.

Check the fire extinguisher condition and pressure gauge regularly, if not before every trip, to ensure that the fire extinguisher is in good operating condition and is fully charged. If the fire extinguisher is damaged or not properly pressurized, replace it.

See the *U.S. Coast Guard Minimum Onboard Personal Safety Equipment Required* section of this manual for specific onboard requirements.

ENGINE EMERGENCY STOP SWITCH AND LANYARD

The engine emergency stop switch, sometimes inaccurately called a kill switch, is an extremely important safety device. Use the engine emergency stop switch when operating the boat's engine. This safety device prevents the boat from becoming a runaway if the operator is accidentally thrown from the seat or away from the helm. The USCG recommends and many states require the use of the emergency stop switch by law. Check with local and state authorities about usage requirements to avoid potential fines.

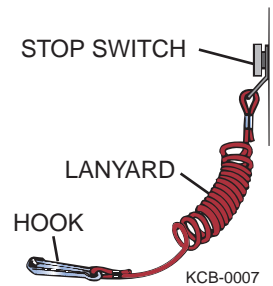

**WARNING**

Control Hazard: Never remove or modify the engine emergency stop switch and/or lanyard.

- ***Always check the switch for proper operation. With the engine running, pull the lanyard. If the engine does not stop, have the switch repaired before continuing to operate the boat. Never operate the boat if the engine emergency stop switch does not work.***
- ***Avoid accidentally pulling the cord lanyard during normal operation. Loss of engine power means loss of most steering control. Also, without engine power, the boat could slow rapidly. This could cause people and objects in the boat to be thrown forward.***

LIFE JACKETS

Boaters enjoy the feel of sun and spray, so it's tempting to boat without wearing a life jacket, especially on nice days. However, the failure to wear life jackets is by far the number one cause of boating fatalities.

Modern life jackets are available in a wide variety of shapes, colors, sizes and technologies. Many are thin and flexible. Some are built right into fishing vests or hunter coats. Others are inflatable and as compact as a scarf or fanny pack until they hit water and automatically fill with air.

There's no excuse for not wearing a life jacket on the water. Boat dealers or marine stores are the best sources for guidance when selecting this most important piece of safety equipment.

Things to Know about Life Jackets:

- Certain life jackets are designed to keep the head above water and help you remain in a position that permits proper breathing.
- To meet USCG requirements, a boat must have a USCG-approved life jacket for each person aboard. Boats 16 feet and over must have at least one Type IV throwable device as well.
- All states have regulations regarding children wearing life jackets.
- Adult-sized life jackets will not work for children. Special life jackets for children are available. To work correctly, a life jacket must be worn, fit snugly and not allow the child's chin or ears to slip through.
- Life jackets can be equipped with whistles, strobe lights, handheld VHF radios and personal locator beacons.
- Life jackets are recommended for open water.
- Test life jackets for wear and buoyancy at least once each year. Discard waterlogged, faded or leaky jackets.



- Properly stow life jackets but make them easily accessible.
- A life jacket, especially a snug-fitting flotation coat or deck-suit style jacket, can help people survive in cold water.

Life Jackets Must Be:

- USCG-approved
- In good and serviceable condition
- Appropriately sized for the intended user
- The best life jacket is the one you will wear

Accessibility

- Wearable life jackets must be readily accessible.
- Boaters must be able to locate and put them on in a reasonable amount of time in an emergency.
- They should not be stowed in plastic bags, in locked or closed compartments or have other gear stowed on top of them.
- Throwable devices must be immediately available for use in emergency situations.
- Though not required, a life jacket should be worn at all times when the boat is underway. A life jacket can save a boater's life, but only if the boater wears it. Set the example and wear it whenever near the water.

Child Life Jacket Requirements

No person may operate a recreational boat underway with any child under 13 years old aboard unless each such child is either: (1) Wearing an appropriate PFD approved by the Coast Guard; or (2) Below decks or in an enclosed cabin.

Some states require that children wear life jackets at all times; check with the state boating safety authorities.

- Applies to children of specific ages
- Applies to certain sizes of boats
- Applies to specific boating operations

Child life jacket approvals are based on the child's weight. Check the "user weight" on the label, or the approval statement that will read something like "Approved for use on recreational boats and uninspected commercial boats not carrying passengers for hire, by persons weighing XX lbs." They can be marked "less than 30," "30 to 50," "less than 50," or "50 to 90."

Since children grow quickly, many boat launches now feature free use of children's life jackets in several different weight categories.



Life Jacket Requirements for Certain Boating Activities Under State Laws

The USCG recommends, and many states require, wearing USCG-approved life jackets:

- For waterskiing and other towed/surf activities, use a life jacket designed for waterskiing. **It is illegal in many states to participate in towed water sports without a USCG-approved life jacket. Be aware that some specialized water sports vests are NOT USCG-approved and should be worn in addition to a USCG-approved life jacket.**
- While operating personal watercraft (PWC) use a life jacket marked for PWC or waterskiing use.

Check with the state boating safety authorities. Other rules may apply if boating in an area under the jurisdiction of the Army Corps of Engineers or a federal, state or local park authority. Special local rules are usually posted at the boat launch.

Type I Life Jacket

This life jacket is designed so that the person wearing it turns to a face-up position when conscious or unconscious. Type I life jackets are the most buoyant and are effective on all waters, especially when rescue is delayed or flotation time is extended.



TYPE I

KC-0003C-A

Type II Life Jacket

This life jacket is recommended for use in calm water near shore on most inland waters where quick rescue is likely. A Type II life jacket is similar to a Type I life jacket, but it is not as buoyant or effective in turning the wearer to a face-up position.



TYPE II

KC-0006C-A

Type III Life Jacket

This life jacket is designed for personal buoyancy when the wearer is alert and conscious. Type III life jackets require users to turn themselves to a face-up position. Type III life jackets are recommended in most inland water applications where quick rescue is likely or when used in the presence of other people.



TYPE III

KC-0004C-A



Type IV Personal Flotation Device

These PFDs are designed to be thrown to a person in the water who can grab and hold it while being rescued. Never wear a Type IV PFD.

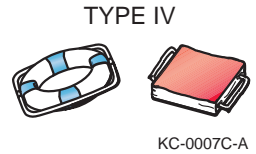

Type V Life Jacket

This life jacket is designed for special activities and may be worn instead of a Type I, II or III life jacket if used in accordance with the approval conditions on the label. If a Type V life jacket is part of the minimum onboard life jacket requirements and if it has a label that indicates “required to be worn,” it must be worn at all times. Otherwise one additional Type I, II or III life jacket must be on board to satisfy the minimum life jacket requirements. Some Type V life jackets provide increased protection against hypothermia.



VISUAL DISTRESS SIGNALING DEVICES

Pyrotechnic devices expire and must be replaced every few years, as stamped on the unit. Be sure to properly dispose of old pyrotechnics.

Distress lights and strobes are equipped with batteries that must be replaced every few years, as stamped on the unit.

Boats less than 16 feet (4.9 meters) must have USCG-approved visual distress signals (VDS) on board when operating between sunrise and sunset in coastal waters, including ocean bays, gulfs and sounds, as well as the Great Lakes, seas, bays and river mouths that are 2 or more miles wide and only to the point proceeding inland where the water narrows to less than 2 miles. Visit the U.S. Coast Guard website for additional information on specific VDS requirements for the boat.

Ensure all passengers on board understand how to operate all VDS. Keep VDS in a readily accessible area and within immediate reach at all times when boating.



VISUAL DISTRESS SIGNALS

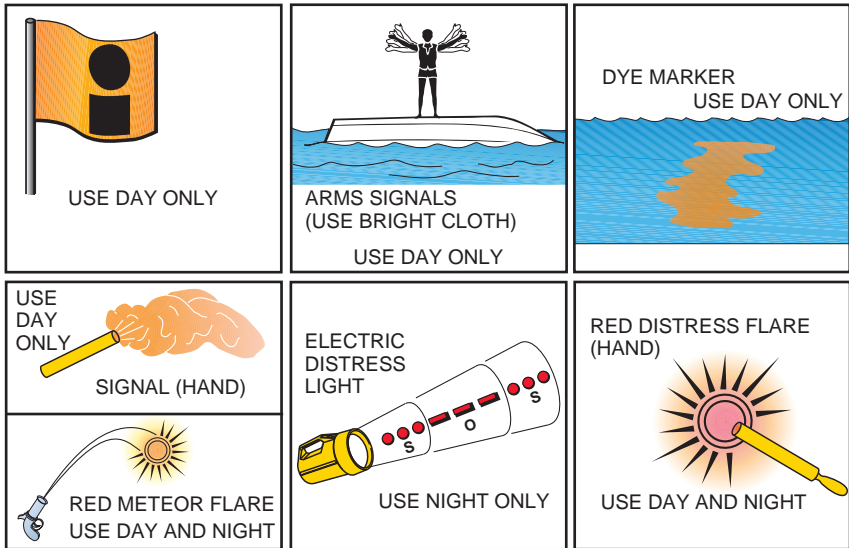

KC-0008C-B

Regulations prohibit using pyrotechnic VDS or any VDS in non-emergency situations.

VDS must be:

- USCG-approved
- In proper operating condition
- Safely stowed and readily available
- Within the clearly marked expiration date stamp on the device (where applicable)

Types of VDS vary by emergency situation. VDS are classified as either pyrotechnic or non-pyrotechnic.

NOTE — Some pyrotechnics may be restricted on certain bodies of water. Check with local authorities, or visit the National Association of State Boating Law Administrators (NASBLA) website: <http://www.nasbla.org> or the U.S. Coast Guard website: <http://www.uscg.mil> for additional information.

See the *U.S. Coast Guard Minimum Onboard Personal Safety Equipment Required* section of this manual for specific onboard requirements.



AUDIBLE SIGNALING DEVICES

Audible (sound) signals are required to be on board all boats to alert other boats of your presence. A boat less than 39.4 feet (12 meters) must always have an efficient sound-producing device on board (Example: hand or mouth whistle, or a compressed or powered air horn).

A boat at least 39.4 feet (12 meters) but less than 65.6 feet (20 meters) operating in inland waterways must always have a power whistle or powered air horn and a bell on board.

All devices must be acceptable for use in marine environments, audible for 1/2 nautical mile and maintain a continuous four- to six-second sound duration. The diameter of the bell's mouth must be a minimum of 7.9 inches (20.0 centimeters).

Ensure all passengers understand how to operate all audible distress signaling devices on board. Keep these devices in a readily accessible area and within immediate reach at all times when boating.

See the *U.S. Coast Guard Minimum Onboard Personal Safety Equipment Required* section of this manual for specific onboard requirements and see the *Navigational Lights and Night Operation* section of this manual for usage information.

NAVIGATIONAL LIGHTS

Navigational lights are intended to alert other boats to your presence and course and their use is essential to boating safety and the prevention of collisions. Knowledge of navigation lights is necessary for the boat operator. Regulations require that navigational lights be clearly lit and properly displayed at all times between sunset and sunrise, and always when operating in reduced visibility. The placement, shape and visibility requirements of navigational lights vary depending on boat size, type, activity and the body of water. Do not allow passengers, gear or stowed items to block navigation lights. Check with local authorities, or visit the NASBLA or U.S. Coast Guard website for additional information.

For additional information, see the *Navigational Lights and Night Operation* section of this manual.



LED LIGHTING

The navigational lighting required by the USCG from sunset to sunrise and in inclement weather is extremely important to boat navigation. The lighting rules are not only designed to indicate direction and right-of-way, but are also designed to prevent night blindness and confusion with navigational aid, emergency and shore-based lights.

NOTICE

Onboard accessory equipment containing red/blue/green (RBG) LED lighting should never be used when underway.

Installing supplemental RGB lighting for “show” can be very dangerous, confusing and distracting to other boaters, and may be illegal. Use caution when changing RGB light color, as some light colors may not be compliant with certain local ordinances. The operator is responsible for complying with local laws and must be familiar with local marine lighting regulations before use, even with certain factory-installed lighting. Blue lighting is typically reserved for law enforcement use only.

Be sure to switch off accessory lighting (not navigation lights) when underway. Use only factory-installed, low-intensity courtesy lighting while on the water.

Never add lighting above the waterline. Avoid lighted accessories such as speakers or light rope.



RECOMMENDED SAFETY EQUIPMENT

Carry and know how to use the following equipment in addition to the required equipment on board at all times as an extra safety precaution:

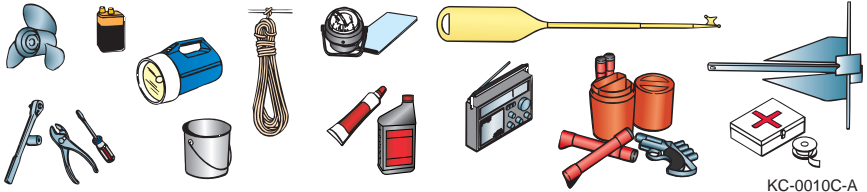

KC-0010C-A

Anchor and line with minimum 75 feet (23 meters) of line	GPS Global Positioning Device
Auxiliary starting battery	Insect repellent
Binoculars	Local charts and compass
Boat hook	Mirror, whistle and strobe light
Cellular phone with waterproof case and lanyard	Mooring lines
Compass	Navigational and interior light bulbs
Dock fenders	Oar/paddles
Dry bag	Propeller, nut and washer
Duct and electrical tape	Radio
Electrical wire	Sharp folding pocket knife
Emergency food and water	Solar USB charger and cable
Emergency Position Indicating Radio Beacon (EPIRB)	Spark plugs
Engine lubricant	Sunglasses and sun block
Extra drain plug	Thermal clothing
Extra transom plug	Throwable life ring
First aid kit and manual	Tool kit including propeller replacement tools
Flashlight and radio batteries	Tow line
Foul weather gear/clothing	VHF-FM/AM with weather band radio
Fuses	Waterproof flashlight



SAFETY AND TRAINING

There is a vast amount of recreational boating regulatory, safety and training information online, and much of it is free. This information covers laws, aids to navigation, rules of the road, hands-on boating safety courses, boat safety checks and much more for both novices and experienced boaters. Go to the following sites for more information:

- United States Coast Guard
www.uscgboating.org
- United States Power Squadron
www.usps.org
- BoatU.S. Foundation
www.boatus.org

SITUATIONAL AWARENESS

A good captain knows that it is important to continuously observe the surroundings and traffic when operating. Good captains also use their eyes to track things around the boat and their ears to hear engine and mechanical issues. Technology should only be used to supplement the conditions and events happening around you and is not meant to replace situational awareness. While available technology and automation help captains see the big picture, the captain is responsible for knowing what is going on around the boat. If possible, post a lookout or lookouts when underway.

Do not get immersed in the boat's technology or blindly follow GPS routes without keeping watch or consulting depth charts. Study the manuals for each piece of equipment and monitor the information for the task at hand, be it depth, traffic, infrared camera, engine data, course or weather.

DRIVING DEFENSIVELY

Sharing boats is becoming more popular in the boating culture. Boating has seen an influx of new, inexperienced and untrained boaters due to peer-to-peer boat-sharing apps. It is increasingly probable that someone on the water "tried" boating because it looked fun. Many of the boat owners sharing their boats do little more than cover safety equipment, starting, stopping and docking instructions. With shares lasting half a day or less, there is little time for much training, let alone covering the rules of the road and navigation.

Boat-sharing is in a legal gray area and is not clearly defined in maritime law. Enforcement of existing rules is nearly impossible and almost always after-the-fact. Operators should assume that the other boat operator is untrained and should drive defensively. Boaters choosing to share their boat should discuss the issue with their



insurance agent first and consider a mandatory captain requirement. Use only reputable sharing services and frequently check for new or updated USCG and state requirements.

SMALL BOATS AND SWIMMERS

Canoes, kayaks, paddleboards and swimming inflatables have become impulse purchases for many, as they appear fun to use and prices have fallen. Most of these operators are new to the sport and have no training on rules of the road or navigation. This is further complicated by the low, thin profile that makes these small boats difficult to see, especially in the sun, glare and rough water. Operators should keep a close lookout for these boats, swimmers and other boats. Assume that the person is untrained and give them plenty of space.

KNOWING THE BOAT

Be thoroughly familiar with onboard systems and other equipment, especially the critical equipment such as throttle and shift controls, steering, backup steering, running lights, fuel filters, sea strainers, etc. Should an emergency arise, the captain will need to act safely and efficiently.

SPECIAL NEEDS PASSENGERS

Keep these special precautions in mind when enjoying a day on the water with passengers who have special needs.

Toddlers

- Never leave children in the boat without adult supervision.
- Must weigh at least 18 pounds (8.2 kilograms), since that is the smallest children's life jacket approved by the USCG. Life jacket must be worn whenever near the water.
- Any device the child is placed in must have flotation.
- Child-proof the boat just like a home. Be sure all gates and compartments are closed and latched.
- Keep a close watch on the child's reaction to speed and conditions and react accordingly.
- Use a higher than normal SPF waterproof sunscreen and re-apply more often than usual.
- Find a safe area to put the child down without risk of going overboard. Allow the child to get accustomed to the surroundings before launching/leaving.
- Keep trips short, but let them have some fun if possible.



Pregnant Women

- Go boating during the day and in calm seas.
- Avoid sharp turns and slow down for large wakes.
- Drink more water than usual to stay hydrated.
- It is a good idea to stay seated in the accommodation deck area while underway.
- Stay close to the home port in the third trimester.

People with Handicaps and Elderly People

Depending on the disability, there are many marine-specialized options available to make boats safer and friendlier. Researching on the internet for your specific needs is the best way to start.

Pets

- Not all pets can swim; consider a life jacket.
- If playing fetch in the water, get a pet-friendly boarding ramp to make re-boarding easier.
- Provide a shaded area and plenty of fresh drinking water.
- Consider foot protection for hot sand and boat surfaces.
- Allow the pet to get accustomed to the surroundings before launching/leaving. Keep the first outing short to allow the pet to get used to the boating environment.



VERY HIGH FREQUENCY (VHF) RADIO

The VHF radio is used to communicate with others on and off the water. VHF channel 16 (156.8 MHz) is designated as the international distress, safety and calling channel and is used to summon rescue services such as the USCG and to make initial contact with ports, marinas, bridges, locks and other boaters in the area. Use a VHF radio. The best way to clearly understand and deal with crossing, overtaking and meeting situations in open water is to communicate with the other boat on the radio.

The responder may then ask the caller for other information to help the caller. It is important to remain calm, speak slowly and be succinct. Short and concise communications are best no matter what the situation is.

Since VHF radios have limited distance line-of-sight (to the horizon) capabilities, it is important for all boaters receiving the distress call to attempt to render assistance until the rescue authorities arrive. The very nature of open water escalates the importance of any distress call. Boaters should always monitor (listening watch) channel 16 but never use it for casual communications. Assist others in distress if possible or monitor the situation until help has arrived.

In other communications, call the other party on channel 16 using your call sign. Bridges and locks will instruct boaters on what to do. Harbors, marinas and other boaters in the area will inform boaters to switch to a particular channel. Most VHF radios transmit in “simplex,” where communication can only take place in one direction at a time. For this reason, standard etiquette is to never interrupt a transmission and to wait 15-30 seconds before making a transmission. There are many channel options available for both commercial and non-commercial use.

NOTICE

The USCG is the lead agency for maritime search and rescue (SAR) in U.S. waters, but that mission is compromised every time the service receives a hoax distress call. Making a false distress call is a violation of federal law (14 U.S. Code § 88) and may result in up to six years in prison, a \$250,000 criminal fine, a \$5,000 civil fine, and reimbursing the U.S. Coast Guard for the cost of performing the search.

Using a VHF radio in foreign waters with a U.S.-registered boat may require a federal Ship Station License by law or treaty. Traveling to a foreign port (for example, Canada, Bahamas, British Virgin Islands and Mexico) requires a Ship Station License as well as a restricted radiotelephone operator permit (RR). Go to www.fcc.gov/wireless/bureau-divisions/mobility-division/ship-radio-stations for more information.

Read the VHF manufacturer’s information on the special features and use of the radio.



CRUISING LIMITATIONS

- Scan constantly for people, objects and other watercraft. Be alert for conditions that limit your visibility or block your vision of others.
- Operate defensively at safe speeds and keep a safe distance from people, objects and other watercraft.
- Do not follow directly behind other watercraft.
- Do not go near others to spray or splash them with water.
- Avoid sharp turns or other maneuvers that make it hard for others to avoid you or understand where you are going.
- Avoid areas with submerged objects or shallow water.
- Operate within your limits and avoid aggressive maneuvers to reduce the risk of loss of control, ejection and collision.
- This is a sophisticated boat—not a toy. Sharp turns or jumping waves or wakes can increase the risk of back/spinal injury (paralysis), facial injuries, broken legs, ankles and other bones. Do not jump waves or wakes.
- Do not operate the boat in rough water, bad weather or when visibility is poor; this may lead to an accident causing injury or death. Be alert to the possibility of bad weather. Take note of weather forecasts and the prevailing weather conditions before setting out in the boat.
- Leave a “float plan” with a responsible person on shore. Tell where you plan to go and when you plan to arrive, and provide a description of your boat. Advise this person if your plans change and also when you arrive to prevent false alarms. Refer to *Float Plan* in this manual for additional information.

HAZARD INFORMATION

- Never start the engine or let it run for any length of time in an enclosed area. Exhaust fumes contain carbon monoxide, a colorless, odorless gas that may cause death within a short time. Always operate the boat in an open area.
- Do not use the reverse function to slow down or stop the boat, as it could cause you to lose control, be ejected or impact the steering wheel or other parts of the boat. This could increase the risk of serious injury. It could also damage the shift mechanism.
- Reverse can be used to slow down or stop during slow speed maneuvering, such as when docking. Once the engine is idling, shift to REVERSE and gradually increase engine speed. Make sure that there are no obstacles or people behind you before shifting into REVERSE.
- Stop the engine and remove the clip from the engine stop switch before removing any debris or weeds that may have collected around the propeller.



WATER SPORTS



WARNING

Control Hazard: It is unlawful to participate in water sports while under the influence of alcohol or other drugs.

Some boats are not designed or recommended to be used for water sports. Use boats equipped with a ski-tow eye or other specially designed line attachment device to pull persons or equipment engaged in a water sport.

Water sports may include, but are not limited to, any activity performed in the water such as swimming, diving, snorkeling, knee boarding, tubing, skiing, parasailing, kiting, gliding or any activity using a device that may be pulled or pushed by a boat.

Check with local and state authorities or water sports clubs and affiliations for additional information.

PLATFORM DRAGGING

Every year tragic deaths occur from the negligence of unsafe boating and dangerous activities.

NOTICE

It is UNLAWFUL to be on or holding on to the boarding platform, swim deck, swim step, swim ladder or any portion of the exterior of the transom at any time while the boat is running or underway in any direction and at any speed.



WARNING

Personal Injury Hazard: Body, teak or platform dragging is extremely dangerous and can be fatal. Never hold on to the transom of a boat while in the water when the boat is running or underway.

- **Do not use the boarding platform or ladder for any purpose other than boarding the boat or entering the water.**
- **Do not use the boarding platform or ladder while the engine is running.**
- **Do not swim under the boarding platform when the engine is running.**

These dangerous and even fatal activities can lead to any or all of the following, as well as other dangers not listed here:

- Carbon monoxide poisoning
- Severe injury from a rotating propeller
- Drowning or entrapment under the water



WATER SPORTS GUIDELINES

Boat Operator, Occupants and Participants

The following water sports guidelines only cover the general conditions that frequently arise. The participants must respond to the constantly changing weather and the conditions of the sea by using reasonable and safe judgment in light of the circumstances.

- Always ensure that all water sports participants and occupants of the boat, especially the operator, are fully aware at all times of the participants' condition and location in the water, as well as the surrounding environment.
- Make safety the primary concern of all involved during the activity. Only allow safe and capable participants to engage in the activity.
- The boat operator and water sports participants must always know their limitations in the activity and never exceed them.
- Never perform water sports in or near:
 - Congested areas
 - Restricted areas
 - Navigation or other waterway markers
 - Other boats
 - Other water sports participants
 - Obstructions in the water
 - Shorelines
 - Shallow water
 - Hazardous weather conditions
 - Hazardous waterways, rapid moving water, dams, spillways, etc.
 - Areas or times of restricted visibility
 - Hours between sunset and sunrise
 - Locations too far from shore that could hinder immediate rescue or emergency help if needed
- Always engage in water sports activities in safe waterways only.
- Always attach the water sports tow rope to approved attachment points on the boat.
- Never jump from a boat that is moving at any speed, and do not enter or exit the water when the engine is running.
- Never use different length ropes simultaneously for water sports activities.
- Always make sure that participants know and use approved skiing hand signals and common skiing courtesies.



- Before starting, always agree to speed and communication hand signals between the boat operator, spotter/observer and participants.
- Before starting, always inspect the water sports equipment and tow eye, tow point and tow line for safe operating condition, or damage that may lead to failure.

Know Water Sports Hand Signals

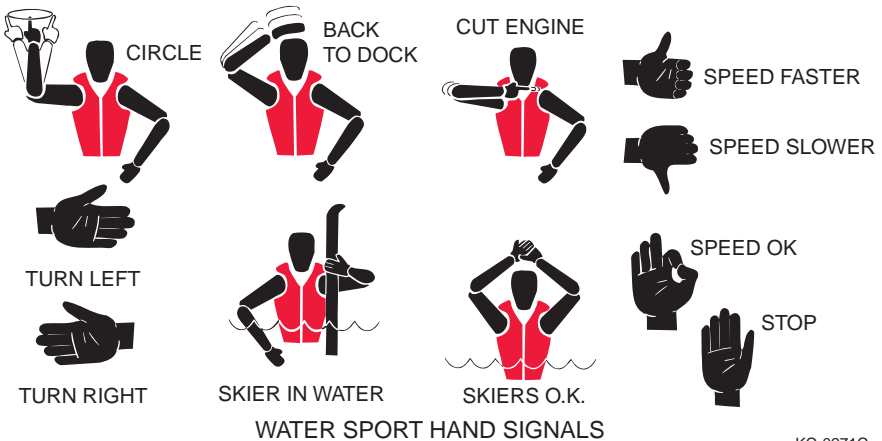

KC-0271C

Boat Operator Specific Guidelines

The following guidelines are for the boat operator while a participant is in the water.

- Always have a “spotter” (designated observer) other than the boat operator on board to ensure the safety of the participants in the water and provide communication to and from the boat operator and the participants.
- Always turn the engine off from a safe distance when approaching participants in the water and allow them to reach the boat. Never run the engine near a person in the water.
- Never operate the boat in reverse to retrieve anyone in the water.
- Always return immediately to a fallen water sports participant. Always approach the participant on the operator’s side while keeping the participant in view from a direction opposite the wind or seas.



- Never drive directly at a person in the water or directly behind another boat.
- Always maintain a safe distance from people and objects in and on the water.
- Always look in the direction you plan to turn before turning the boat to pick up a fallen skier.
- Never retrieve any object from the water while the engine is running.
- Always keep the skier in view when the skier is entering or exiting the boat.
- Always watch the skier as the line begins to tighten (in case the rope wraps around ski or skier).
- Always look ahead before starting.
- Always start from a safe place with good forward and peripheral visibility.
- Always check direction of steering before starting, ensuring that the boat steers straight.
- Always be aware of what is occurring in front of the boat, and of a participant's condition.
- Always display a "skier down" flag whenever a skier is in the water and not skiing.
- Always follow the approved towing pattern for the waterway in which you are operating.

Additional Guidelines for Participants in the Water

The following guidelines are for the water sports participant.

- Never participate in water sports if you cannot swim.
- Always wear a bright-colored USCG-approved activity life jacket at all times. Wear suitable protective clothing or gear and/or a wet suit to prevent impact injuries, abrasions and hypothermia.
- Never approach or enter the boat if the engine is running.
- Always avoid the boat's propeller. Even when the propeller is not rotating, its sharp edges can cause serious injury.
- Never put any part of your body through the handle of the ski line or wrap the line around any part of your body.
- Never enter the water from a boat that is running or moving at any speed.
- Always indicate that you are clear of the boat prior to the operator starting the boat or putting the boat into gear and tightening the rope.



RE-BOARDING – 2020 MODEL YEAR

Lift Systems: ABYC H41.10

Using the Boarding Platform Ladder

Every Bennington boat is equipped with a ladder when it leaves the factory. The ladders are designed so a person can deploy it while in the water and get into the boat without the assistance of others. Your boat is equipped with one of two types of ladders: Aluminum or Stainless Steel. Ladders are usually located on the starboard side; however, some boats have this ladder near the port side gate.

⚠️ WARNING *Personal Injury Hazard: Always turn the engine off whenever anyone is in the water near the boat.*

Boarding ladder precautions:

- NEVER allow anyone in the water near the boarding ladder while the engine is running.
- ALWAYS be sure the ladder is fully retracted and secured after use, before operating the boat.

To deploy an **aluminum** ladder, unsnap the strap and extend the ladder rearward.



BENN_0015



To deploy a **Stainless Steel** ladder, push the ladder forward a bit, lift to release the catch pins, pull all the way out and swing down to use.



BENN_0016

Water Sports Safety

IMPORTANT

The following water sports safety warnings and practices represent some (but not all) common risks encountered by users. Always use common sense and good judgment.

Before skiers/riders get in the water: Waterskiing or riding instruction is recommended in advance. Instruction will teach general safety guidelines and proper waterskiing or riding techniques, which may reduce their risk of injury. For more information on waterskiing or riding schools, contact the dealer, association or local waterskiing club.

Inspect all equipment prior to each use. Check bindings, fins, tube, attachment, tow rope and flotation device. Do not use if damaged.



Special boat considerations: A knowledgeable and responsible driver along with a separate observer is the most important safety device on any boat.

- Some states have specific regulations for allowable propulsion systems that can be used for tow sports, especially wake surfing. It is the operator's responsibility to know the applicable regulations.
- Never exceed the passenger or weight limitations of the boat.
- Never allow passengers to hang outside the boat or towed device or sit on the gunwales or anywhere outside of the normal seating area.
- Never allow water to overflow the bow or gunwales of the boat.
- Uneven weight distribution or additional weight may affect the handling of the boat.

Tow ropes: Tow ropes come in different lengths and strengths for different activities. Make sure any rope used is suited for that activity and that it is in good condition.

- Never use a rope that is frayed, knotted, unraveling or discolored from use or being left in the sun. If a rope breaks while in use, it can recoil at the skier/rider being towed or into the boat where it might strike passengers. Replace tow ropes with any sign of damage.
- Never use a tow rope with elastic or bungee material to pull skiers or riders.
- Rope should be attached to the boat in an approved fashion with hardware designed for towing. Refer to the boat manual for instructions on proper tow rope attachment.
- Always keep people and tow ropes away from the propeller, even when idling.
- If a tow rope should become entangled in a propeller, shut off the engine, remove the key and secure it in a safe location before retrieving the rope.
- Tow ropes should be neatly stowed in the boat when not in use.

Preparing to ski or ride: Always have a person other than the driver act as an observer to look out for the skier/rider.

- Be sure the driver is aware of the experience and ability level of the skier/rider.
- The driver, observer and skier/rider need to agree on hand signals before skiing or riding. Signals should include READY, STOP, SPEED UP and SLOW DOWN.
- Start the engine only after making sure that no one in the water is near the propeller.



- Turn off the engine when people are getting into or out of the boat, or in the water near the boat.
- Always make sure the tow rope is not wrapped around anyone's hands, arms, legs or other parts of the body.
- Start the boat and move slowly to remove slack until the tow rope is tight.
- When the skier/rider signals READY "hit it" and there is no traffic ahead, take off in a straight line. Adjust the speed according to the signals given by the skier/rider.

Skiing or riding: The boat and skier/rider should always maintain a sufficient distance from obstacles so a skier/rider falling or coasting and/or boat will not encounter any obstacle.

- Do not use in shallow water or near shore, docks, pilings, swimmers, other boat or any other obstacles.
- Use only on water.
- Never attempt land or dock starts or stops. This will increase the risk of injury or death.
- The faster the skier/rider skis or rides, the greater their risk of injury. The skier/rider should be towed at an appropriate speed for his or her ability level.
- Never make sharp turns that may cause a slingshot effect on the skier/rider's speed.

Fallen skier or rider: Falling during water sports is commonplace and injuries can occur from a variety of causes.

- If the skier/rider does not immediately indicate that they are "OK," assume that they need assistance.
- Circle a fallen skier/rider slowly to return the tow rope handle or, pick up the fallen skier/rider.
- Turn off the engine when near a fallen skier/rider.
- Always keep the fallen skier/rider in view and on the driver's side of the boat.
- Display a red or orange "skier down" flag to alert other boats that a skier/rider is down if required by the state in which you are operating.

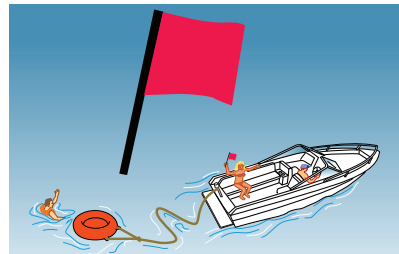

KC-6017



Water Sports and Towing Safety

Boat operators, skiers and boarders must all be aware of current boating and water sports rules and pay attention to safe operating procedures and skiing practices at all times. If skiing or boarding is a new sport to you, seek certified training before starting. Thoroughly read all information provided by the water sports equipment manufacturer.

Always remember that the majority of water sports injuries are the result of impacts with other objects. Know the area you are boating in.

Always maintain a clear vision of where you are going and be aware of what is going on around you. Constant vigilance will go a long way toward preventing accidents. Skiers, boarders and other water sports participants must always wear a USCG-approved life jacket. It's the law!

Contact with rotating propellers is one of the most dangerous hazards that occurs from negligence of operators, passengers and bystanders. A propeller is designed to travel in the water and rotates at a speed that can cause death if it comes into contact with a human. Severing, deep lacerations, blood loss, trauma and exposure to microorganisms in the water that enter the bloodstream can result in death or serious injury.

STOP PROPELLER STRIKES by always using caution and:

- OBSERVING all warnings and keeping all safety equipment in use and in place.
- STOPPING the engine when swimmers are near the boat and in the water.
- MAKING SURE all passengers are seated on a horizontal seat cushion whenever the boat is in gear or moving.
- NOT ALLOWING passengers to enter the water when the engine is running.
- USING the boat's emergency stop switch at all times.
- MAKING SURE all operators are properly trained and qualified to operate the boat.
- KEEPING your eyes on your path as well as the water sports participant.
- NOT ALLOWING water sports participants to be in the path of other boaters.
- STAYING CLEAR of swimmers and other water sports participants by maintaining visual surveillance.
- KNOWING the correct water sports hand signals.
- NOT ALLOWING children under 11 years of age to occupy the open bow area unless accompanied by an adult.
- USING an observer during water sports activities.



Water Sports Responsibility Code

BE AWARE there are risks in boating and water sports that good judgment and personal awareness can help reduce. To increase enjoyment of water sports, follow the 10 points of the code.

In water sports, it is the boater's responsibility to:

- ALWAYS become familiar with applicable laws, waterways and inherent risks.
- ALWAYS have a capable observer in addition to the driver, and use agreed-on hand signals.
- ALWAYS wear a properly fitted life jacket approved by your country's agency.
- ALWAYS read the user's manual and inspect equipment before use.
- ALWAYS ski and ride under control, at proper speeds and within your limits.
- ALWAYS turn the ignition off when anyone is near the boat power drive unit.
- ALWAYS stay clear of engine exhaust to avoid carbon monoxide poisoning.
- NEVER "platform drag" or touch boarding platform while the engine is running.
- NEVER ski or ride near swimmers, shallow water, other boats or obstacles.
- NEVER operate boat and never ski or ride under the influence of alcohol.

Driver: Best Practices

- The boat driver plays a critical role in the enjoyment and safety of all towed water sports participants. Do not allow inexperienced drivers to drive for skiers/riders without thorough instruction and training. We encourage all boat operators to take a boater's education course. See the state's boating authority for available courses or other operating requirements.
- Keep music at reasonable levels. Sound travels well over water.
- Wait for a clear boat path ahead before accelerating.
- Make sure to use the proper rope for the sport. A rope designed to pull a skier is not the recommended rope for towing a tube.
- If skiing, boarding or tubing with more than one person, make sure all tow ropes are the same length.
- Keep a 150-foot buffer zone on all sides of the boat and stay in water that is safe for the skier/rider and draft of the boat.
- Make sure the tow line unwinds smoothly without getting snagged on anyone or anything.



- Idle forward to make the rope tight.
- Accelerate only when the tow rope is completely tight and the skier/rider has given the “hit it” signal. The words GO and NO can be easily confused with nearby wind, water and engine noise. It is best to find another signal other than GO to tell the driver to power up. “Hit it” or “boat driver” are better options.
- Always approach fallen skiers/riders in the water from the driver’s side so the driver does not lose sight of them.
- Minimize repetitive passes on any one portion of shoreline. Once you’ve run the same line for a while, move on to another area.

TURN OFF ENGINE when a skier/rider is near the boat, rather than running the engine in NEUTRAL. An accidental bump of the throttle when the engine is running could put the boat in gear.

- DO NOT let the tow rope slip under the boat and become tangled in the propeller. It is a good practice to keep a knife on board should this situation occur.
- Always pay attention to the water ahead, the surrounding traffic and the onboard observer. The observer must always keep the boater aware of the skier/rider status.
- DO NOT whip skiers or riders near shores, docks, other boats or fixed obstructions; they can glide 100 feet or more after they let go of the rope.

**WARNING**

Entanglement Hazard: Never accelerate before the rope is 100% tight and before the skier/rider gives the “hit it” signal. Accelerating before the “hit it” signal is given could result in the skier/rider becoming entangled in the rope.



Driving Pattern

Check with local lake laws before driving any pattern. Some areas require operators to drive skiers/riders in preset patterns.

Operators who want to minimize the rough water for the skier/rider should use a dog-bone pattern when driving. A dog-bone pattern follows the same path from one end of the course to the other, with tight controlled turns at each end. Use this pattern where few other boats are operating.

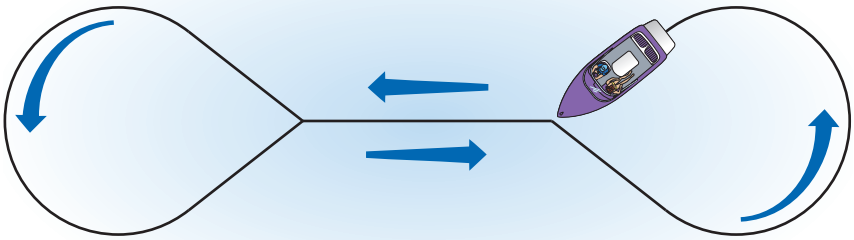

KC-0317C-A

In areas where many boats are operating, use a large racetrack pattern.

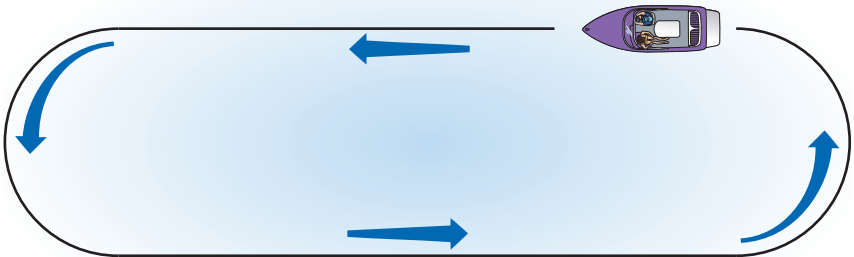

KC-0358



Falling Tips for Every Sport

- Sudden falls happen. DO NOT put any body parts (arms, legs, head) inside the rope handle.
- Tighten the life jacket straps for a snug fit.
- Let the handle go as soon as you sense you're about to fall. Falling is better than dragging.
- Roll with it. Bow your head, bend your knees, tuck in your arms and make like a beach ball.
- Signal the observer to let them know you are OK after a fall.
- After you fall, lift the ski or board above the water so other boaters can see you.
- When learning advanced maneuvers, it's best to seek training from a professional.
- A little advice will cut down on falls, shorten the learning time and reduce the chances of an injury.

Water Sports Tips

These tips are designed to help speed learning while ensuring safety. Practice, training from a professional and advice from experienced boaters are the best tools for learning safety when it comes to water sports.

For additional information visit: www.usawaterski.org

REMEMBER: It is important to follow the manufacturer's recommendations for the intended use of the water sports equipment.

REMEMBER: It is illegal in many states to participate in towed water sports without a USCG-approved life jacket. Be aware that some specialized water sports vests are NOT USCG-approved and should be worn in addition to a USCG-approved life jacket.

BE AWARE: The boater is responsible for their own wakes. Be considerate of other boaters, especially small fishing boats, canoes, kayaks, paddleboards and other low-profile boats that can overturn easily. Also, be aware of your wakes in relation to swimmers, docks and boats tied to docks.



SECTION

2

SAFETY

This Page Intentionally Left Blank

Section 3

BOATING REGULATIONS AND YOUR RESPONSIBILITIES

The U.S. Coast Guard (USCG) is the federal authority on U.S. coastal and inland waterways, but state and local regulations may exist that exceed USCG regulations. The purpose of all these regulations is to assist the boating public and maintain navigational order on waterways.

Many state equipment requirements go beyond USCG requirements. Contact state and local boating authorities for further information. Equipment requirements for coastal and inland waters differ. Check with local authorities or the USCG for further information about coastal water requirements.

Boating regulations are enforced by USCG, state and local authorities. Operators/owners are subject to marine navigation regulations for both federal and state waterways. Operators/owners must comply if enforcement officers signal them to stop the boat or if they ask to board the boat.

Many USCG, state and local resources are available. For additional and current information on regulations, safety and navigation, contact the local USCG unit or local marine authority.

See the *References and Contact Information* section of this manual for a list of resources.

BOAT OWNER / OPERATOR RESPONSIBILITIES

As a boat owner/operator, understand and be aware of USCG federal regulations as well as state and local regulations where operating the boat. Boating regulations include, but are not limited to, boat regulations, boat equipment regulations and navigational regulations.

Operators/owners must have on board at all times all mandatory safety and boat equipment as regulated by the governing authorities. All equipment must be maintained in proper working order.

SAFETY

Boat owners/operators are legally responsible for their safety, the safety of their passengers and the safety of other boaters. In addition, they are responsible for the operation and navigation of the boat under all operating conditions. The boat must be in compliance with USCG safety equipment regulations.



REGISTRATION

The USCG requires that all power boats operated on the navigable waters of the United States be currently registered in the state in which they are principally used. Many states require current registration in that state whenever boating on waters within their state boundary. Always contact state boating authorities (and authorities in neighboring states) for registration information on boats and trailers.

Registration numbers must be current and clearly displayed on the boat according to the defined regulations. Registration certificates must be current and on board at all times.

State and local authorities may require additional registration for boating on certain waterways. Check with state and local authorities for additional registration information.

For more information visit:

- U.S. Coast Guard Office of Boating Safety:
<http://www.uscgboating.org>
- National Association of State Boating Law Administrators:
<http://www.nasbla.org>

INSURANCE

Boat owners are legally responsible for any damage or injury caused when they operate the boat when an accident or collision occurs. They are also legally responsible even when someone else operates the boat and causes damage or injury. Individual states have laws detailing minimum insurance needs. Contact the insurance agent to verify the type of insurance needed BEFORE operating the new boat.

REPORTING ACCIDENTS

The USCG requires the owner/operator of a boat involved in an accident to report the incident to the proper marine law enforcement agency for the state in which the accident occurred. If a person dies or disappears as a result of a recreational boating accident, the boat owner/operator must immediately notify the nearest state boating authority. If a person dies or has injuries requiring more than first aid, the owner/operator must file a formal report within 48 hours of the accident. An owner/operator has 10 days to file a formal report for accidents exceeding \$500 in property damage or complete loss of the boat. Go to <http://uscgboating.org/recreational-boaters/>, Accident Reporting, for information and form download.



BOATING UNDER THE INFLUENCE



KCB-0011

Federal and state laws prohibit the operation of a boat while under the influence of alcohol or drugs, and authorities actively enforce these regulations. If the operator's blood alcohol content is at or above the legal limit, violators are subject to civil and criminal penalties and imprisonment. Operating a boat under the influence can also result in a loss of motor vehicle driving privileges.

Alcohol and drugs slow reaction time and affect judgment. This type of impaired operation may result in death or severe personal injury.

Owners/operators are responsible for their passengers, including alcohol and drug use and onboard behavior.

Regulations and penalties for operators and passengers may vary from state to state. Contact local and state boating authorities for specific information.

OPERATOR'S LICENSE AND EDUCATION

This manual does not provide complete training on all aspects of boating safety, operation or regulations. Boating authorities highly recommend that all boat operators and passengers seek additional training in boating safety and seamanship from a USCG-approved course.

Licensing requirements can vary widely from state to state. Most states require operators under the age of 18 to be licensed; however, some states require all operators to be licensed and have the license on the boat during operation. Some states require boat operators to complete a boating education/safety course to obtain a safety certificate before licensure. Pay special attention if you will be operating on boundary waters shared by two or more states, as the requirements may change once you cross the boundary.

Check with state and local authorities for requirements of an operator's license, certificate or training before you or anyone operates the boat.

See the *References and Contact Information* section of this manual for a list of some of the agencies and organizations that offer water/boating safety courses, first aid/CPR, or other recommended training and/or information.

OPERATION BY MINORS

Minors must always be supervised by an adult whenever operating a boat. Many states have laws regarding the minimum age and licensing requirements of minors. Regulations may vary from state to state. Contact local and state boating authorities for specific information.



EMERGENCY ASSISTANCE

An operator seeing a distress signal or suspecting a boat is in trouble must assume it is a real emergency and render assistance immediately as long as it can be done safely.

In accordance with Federal law, in U.S. waters, the operator must render assistance to any individual found at sea in danger of being lost, so far as the operator can do so without serious danger to the operator's vessel or individuals on board. An operator who fails to render such assistance can be fined not more than \$1,000, imprisoned for not more than 2 years, or both. The 1971 Boating Safety Act grants protection to a "Good Samaritan" boater providing good faith assistance, and absolves the boater from any civil liability arising from such assistance.

Under general maritime law in international waters on the other hand, if the operator undertakes to perform acts to rescue or aid those in distress, the operator is subject to liability for reckless or wanton conduct or, for failure to exercise reasonable care (negligence) if he worsens the position of the victim.

NOTICE

The operator in charge of the boat is obligated to provide assistance to any individual in danger if such assistance can be provided safely. Carefully assess the situation at hand and assist if possible. If the operator does not possess the skills to safely assist another boat in trouble with the highest degree of care, call for help and stay in the area until help arrives.

NEGLIGENT OPERATION

Federal law prohibits the negligent or grossly negligent operation of a boat and/or interference with the safe operation of a boat so as to endanger lives and/or property. Some actions that may constitute grossly negligent operation (criminal offense) are:

- Operating a boat in a designated swimming area
- Excessive speed in the vicinity of other boats or in regulated waters
- Hazardous waterskiing or other water sports practices
- Bow riding, or riding on a seat back, gunwale, boarding platform or transom
- Operating a boat while under the influence of alcohol or drugs (severe penalties may be imposed for boating under the influence [BUI])



Other actions that constitute negligent operation, such as, but not limited to:

- Failure to use handhold
- Overloading or improper loading
- Using a boat in weather or sea conditions beyond the intended design of the boat or beyond the skill or experience of the operator
- Continued operation with operator's visibility blocked or impaired
- Modification to boat causing an unsafe operating condition

RESTRICTED AREAS

SECURITY ZONES

Operators must avoid all waterways and areas that are restricted, such as military installations, power plants and petroleum and chemical facilities. Because of the threat of terrorism, the U.S. Coast Guard has implemented and will continue to enforce strict limits on boats near U.S. Navy and U.S. Coast Guard ships and other potential targets.

NAVAL VESSEL PROTECTION ZONES

Do not approach within 100 yards of any U.S. Naval vessel. Slow to minimum speed within 500 yards of any U.S. Naval vessel. Operators needing to approach within 100 yards to ensure a safe passage in accordance with the Navigation Rules must contact the U.S. Naval vessel or the U.S. Coast Guard escort vessel on the boat's VHF radio (channel 16) for authorization.

COMMERCIAL SHIPPING SAFETY ZONES

Do not operate the boat near cruise liners or certain waterfront commercial installations such as ferry terminals. Observe and avoid all security zones and commercial port operations.

BRIDGES AND SHIPPING CHANNELS

Do not stop or anchor beneath bridges or in shipping channels. Operators doing so should expect to be asked to move and/or be boarded by law enforcement officials. Anchoring in these areas is dangerous for the operator and others on the water.



AMERICA'S WATERWAY WATCH

Boat operators can help the U.S. Coast Guard in keeping waterways and coastal installations safe and secure. Boat operators can do this by participating in America's Waterway Watch (AWW). Boaters reporting suspicious activities to AWW should call 877-24WATCH if noticing suspicious activity or behavior on or near the water.

In cases of immediate danger to life or property, call the U.S. Coast Guard on channel 16 VHF-FM or dial 911 for emergencies.

FISHING

Fishing can be very exciting and distracting for the operator when the action gets intense. Operators must always be conscious of the primary responsibility, which is the safe operation of the boat and the safety of passengers and other boats in the area.

Always make sure the helm is properly manned and is never left unattended while trolling. If the boat is equipped with a tower, exercise caution and sound judgment whenever someone is in the tower. Remember, weight in the tower raises the boat's center of gravity and the boat's motion is greatly exaggerated for the person in a tower.

An operator fishing in an area that is crowded with other fishing boats may have difficulty following the rules of the road. This situation can become especially difficult when many boats are trolling. Being courteous and exercising sound judgment is essential. Avoid trying to assert the right-of-way and concentrate on staying clear of other boats. Prevent the boat from becoming entangled in lines and from cutting into lines. Also keep in mind that fishing line wrapped around a propeller shaft can damage seals in the engine lower unit.

There is currently a tremendous drain on our fishing resources. Excessive fishing and hunting, as well as pollution, have strained the fish and game population. Help out by keeping only what you will eat; practice catch-and-release and obey bag limits.



MONOFILAMENT FISHING LINE

Wildlife can experience harm from becoming entangled in or ingesting monofilament fishing line if it is left in the water or on shore. Line in the water can also endanger swimmers and divers and become tangled in boat propellers, causing damage. It can last for years in water, posing a threat for a long time. Fishing line can remain a problem even if put in the trash, because birds can take it from an open bin and become entangled or it can entangle wildlife at landfills.

Many states and private boating/wildlife organizations sponsor programs to collect used line for recycling into new products. Operators who carry used line or happen upon it while boating can dispose of it in recycling bins located at many marinas, launches, tackle shops and state service centers.

WAKE

Boat owners/operators are responsible for the wake the boat creates. Regulations may vary from state to state. Contact local and state boating authorities for specific information, as owners/operators may be responsible for any damage or injury their wake causes. Always be alert for no-wake zones and be courteous of others while boating. Excessive and unexpected wakes can cause dangerous and even life-threatening situations.

NOISE

Boat owners/operators are responsible for the noise the boat creates. Many state and local boating authorities enforce noise limits that may restrict engine noise, radio volume or even loud talking. Regulations may vary from state to state. Contact local and state boating authorities for specific information.

SPEED

Boat owners/operators are responsible for maintaining the boat under control at a safe speed. Many state and local boating authorities enforce speed limits. Regulations may vary from state to state. Contact local and state boating authorities for specific information.



PROTECTING THE ENVIRONMENT

Our lake, river and ocean resources must be protected to be enjoyed by future generations. Boat owners/operators are responsible for protecting the natural environment and wildlife by keeping waterways clean.

U.S. waters are covered by several water pollution regulations administered by numerous federal and state agencies. Laws vary between local, inland, coastal, ocean and international waters. Laws can be enforced by local and state authorities as well as the USCG. For recreational boats, U.S. Federal Water Pollution Control, Oil Pollution Control and Refuse Acts cover U.S. waters, and the MARPOL treaty covers international waters. In any case, pollution prevention centers around three areas:

- Sewage pollution
- Garbage (solid waste) pollution
- Oil pollution





As a boater, make it a point NOT to dump or discharge ANYTHING into waters and tell passengers to respect this rule. Return all trash after boating and dispose of it properly on shore.

Trash Overboard Labels and Oil Discharge Labels are carriage requirements for all boats 26 feet in length and greater, as prescribed by Annex V of the MARPOL treaty. As the boat owner, you have been provided with one of each of these labels. You are required to install these labels at the locations described below.

Trash Overboard Label

Install in a prominent location in plain view.

It is illegal for any vessel to dump plastic trash ANYWHERE in the ocean or navigable waters of the United States. Annex V of the MARPOL TREATY is an International Law for a cleaner, safer marine environment. Violation of these requirements is a Class D felony and may result in civil penalty up to a \$25,000 fine and imprisonment.

			
U.S. Lakes, Rivers, Bays sounds and 3 miles from shore	3 to 12 miles	12 to 25 miles	Outside 25 miles
ILLEGAL TO DUMP	ILLEGAL TO DUMP	ILLEGAL TO DUMP	ILLEGAL TO DUMP
Plastic & Garbage	Plastic	Plastic	Plastic
Paper	Dunnage, lining & packing materials that float, also if not ground to less than one inch	Dunnage, lining & packing materials that float	
Metal	Rags		
Crockery	Crockery		
Glass	Glass		
Dunnage	Food		
Food			

Regional state and local regulations may further restrict the disposal of garbage. The discharge of all garbage into the Great Lakes or their connecting or tributary waters is prohibited.



BENN_0003



Oil Discharge Label

Install in engine space or bilge pump control area.

DISCHARGE OF OIL PROHIBITED

THE FEDERAL WATER POLLUTION CONTROL ACT PROHIBITS THE DISCHARGE OF OIL OR OILY WASTE INTO OR UPON THE NAVIGABLE WATERS OF THE UNITED STATES, OR THE WATERS OF THE CONTIGUOUS ZONE, OR WHICH MAY AFFECT NATURAL RESOURCES BELONGING TO, APPERTAINING TO, OR UNDER THE EXCLUSIVE MANAGMENT AUTHORITY OF THE UNITED STATES, IF SUCH DISCHARGE CAUSES A FILM OR DISCOLORATION OF THE SURFACE OF THE WATER OR CAUSES A SLUDGE OR EMULSION BENEATH THE SURFACE OF THE WATER. VIOLATORS ARE SUBJECT TO SUBSTANTIAL CIVIL PENALTIES AND/OR CRIMINAL SANCTIONS INCLUDING FINES AND IMPRISONMENT.



BENN_0004

MARPOL TREATY

The USCG enforces the International Convention for the Prevention of Pollution from ships, commonly referred to as the MARPOL Treaty (MARine POLLution). This treaty prohibits the overboard dumping of all ship-generated plastics, chemicals, garbage and oil. Contact the USCG for further information.

AQUATIC INVASIVE SPECIES (AIS)



KC-6027

Aquatic Invasive Species (AIS) are plants and animals that occur in waters in which they are not native and whose introduction causes or is likely to cause economic or environmental damage or harm to human health. AIS have a negative impact on the waterway, its native species, and recreational and commercial uses of the waterway. As responsible boaters and citizens, each boat owner should do their part to prevent the spread of these aquatic hitchhikers.

In many cases, it is also required by law. Check local regulations for any waterway where you will boat.



SECTION
3

BOATING REGULATIONS AND YOUR RESPONSIBILITIES

After each boating trip, follow these three simple steps before you leave the water access to stop the spread of AIS: Clean, Drain, and Dry. This is the boater's way to help protect the environment from the damage that AIS can cause.

Clean

- Inspect and remove all aquatic plants, animals, mud, and debris from the boat, engine, trailer, anchor, and any watersports equipment.
- Rinse, scrub or wash, as appropriate, away from storm drains, ditches, or waterways.
- Rinse watercraft, trailer, and equipment with hot water, when possible.
- Flush motor according to owner's manual.

Drain

Completely drain all water from the boat and its compartments, including but not limited to the bilge, wells, lockers, ballast tanks or bags, bait containers, engines, and outdrives.

Dry

Allow the boat to completely dry before visiting any other bodies of water.

NOTE — Some localities may require inspection or decontamination before and/or after launching. Check state and local laws and regulations for requirements prior to traveling to go boating.

PAINTS

Boat owners are responsible for the environmental regulations that may govern the use of antifouling paint. If the boat is kept in water where marine growth is a problem, the use of antifouling paint may reduce the growth rate. Regulations may vary from state to state. Contact local and state boating authorities for specific information.

CLEANING AGENTS

Boat owners are responsible for the environmental regulations that may govern the use of cleaning agents. There are many "green" cleaner choices available for most any material on the boat. If using household cleaners, use them sparingly and never discharge them into waterways. Do not mix cleaners and be sure to use plenty of ventilation in enclosed areas. Avoid using chlorine, solvents and products that contain phosphates, as well as non-biodegradable or petroleum-based products. Regulations may vary from state to state. Contact local and state boating authorities for specific information.



EXHAUST EMISSIONS

Boat owners are responsible for the exhaust emissions from the boat. Increased exhaust (hydrocarbon) emissions, which are regulated by the EPA, pollute the water and air. Contact the dealer and the engine manufacturer for more information. Additional restrictions may apply and vary from state to state. Contact local and state boating authorities for specific information.

ADDITIONAL PROPOSITION 65 INFORMATION

A wide variety of components used on this boat contain or emit chemicals known to the state of California to cause cancer, birth defects and other reproductive harm.

Examples include:

- Engine and generator exhaust
- Engine and generator fuel and other liquids, such as coolants and oil, especially used motor oil
- Cooking fuels
- Cleaners, paints and substances used for boat repair
- Waste materials that result from wear of boat components
- Lead from battery terminals and from other sources, such as ballast or fishing sinkers

To avoid harm:

- Keep away from engine, generator and cooking fuel exhaust fumes.
- Wash areas thoroughly with soap and water after handling the substances above.



SECTION
3

BOATING REGULATIONS AND YOUR RESPONSIBILITIES

This Page Intentionally Left Blank

Section 4

EMERGENCIES

Be prepared to deal with emergencies before they happen. Try to formulate a plan for each type of emergency in advance in order to make decisions quickly and without hesitation. Precious moments lost can mean the difference between losing and saving a life.

Before operating the boat, review *Safety in Section 2*.

FIRST AID / MEDICAL EMERGENCIES

Every second counts toward preventing injury or death in case of a medical emergency. Boaters must have proper training and take necessary preventive measures to properly assist in times of need. Carrying an adequate and current first aid kit is critical in the immediate response and care of someone in need of medical attention. Always have dry blankets readily accessible to help prevent hypothermia. For additional information on medical, first aid and safety training such as CPR, contact your state and local authorities, or visit the Red Cross website:

<http://www.redcross.org>.

EMERGENCY PREPARATION CHECKLIST

In addition to a safety equipment list, have an emergency checklist on board to assist in times of emergency. Use the following topics as a guideline to develop a list of emergency procedures and instructions for the use of visual and audible distress signaling devices, radios, first aid kits and all related information that could assist you or others in the event of an emergency.

USING DISTRESS SIGNAL DEVICES AND CALLING FOR HELP

Ensure all passengers understand how to operate all onboard visual and audible distress signaling devices and communication equipment. Keep all distress signaling devices and communication equipment in a readily accessible area and within immediate reach at all times.

An emergency can occur when you least expect it. Be sure you and your passengers know how to use all types of distress signaling devices.

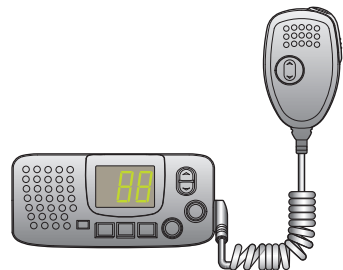

KC-0246C-B



See the *Markers, Warnings and Advisories* section of this manual for more signaling devices.

Seconds count during emergencies. Knowing the proper way to use the distress signaling devices aboard the boat can help save lives.

- **MAYDAY radio call** – A mayday call is reserved for life-threatening situations, such as fire, severe weather or sinking, where lives are in imminent danger or the boat is in danger of sinking. Start the broadcast clearly and calmly with **“Mayday - Mayday - Mayday.”**
- **PAN-PAN (pahn-pahn) radio call** – A pan-pan call is used for urgent but non-life-threatening situations where there is no immediate danger to lives or the boat, such as a loss of steering control or taking on water of any amount. Start the broadcast clearly and calmly with **“Pan - Pan - Pan.”**
- **Securite (se-cure-ih-tay) call** – A securite call is used for non-life-threatening situations to notify authorities and others in the vicinity of important navigation and weather alert calls. Start the broadcast clearly and calmly with **“Securite - Securite - Securite.”**

In an emergency situation the responder needs to know four important pieces of information:

- The exact nature of the emergency and an assessment of the severity
- Number of people on board
- The location (navigation marker, visual reference or GPS coordinates in open water)
- What the boat looks like (hull and top colors, unique features, flags, etc.)

For additional information on the safe and proper use of distress signaling devices and the safe and proper use of emergency communication equipment, contact state and local authorities. Additional information can be found on the USCG website:

<http://www.uscgboating.org>.

REQUESTING ASSISTANCE (NON-DISTRESS CALL)

If a boater contacts the USCG on Channel 16 VHF-FM or Channel 70 DSC regarding a non-distress situation, the USCG will offer to contact any assistance provider (commercial or friend) the boater requests or will issue a Marine Assistance Request Broadcast (MARB) if the boater has no preference of service.



LAW OF SALVAGE

If boaters require assistance while cruising in the Great Lakes, coastal or ocean waters, they should use caution **before** allowing any towing company or private agency to pass a line to the boat. The law of salvage says, among other things, “...any vessel, if rendered assistance from a towing company or private agency, can be forced to relinquish a portion of the vessel’s worth for the assistance received.” While this is very rare with recreational boats, it can happen.

Before taking the line boaters must establish that they do not agree to any salvage rights and wish to be assisted on a contract basis. Boaters must then establish the contract price and payment terms. Boaters should accept the tow line only when the captain of the company/agency acknowledges the contract price and payment. Most tow companies are reputable and post terms and pricing on their websites.

If boating in the Great Lakes, coastal or ocean waters, it is a good idea to have a membership in a national towing service. This membership can significantly reduce the costs of towing if ever needed.

FIRE AND EXPLOSION



WARNING

Fire/Explosion Hazard: Gasoline is extremely flammable and highly explosive under certain conditions.

- Do not smoke or allow open flames or sparks nearby when refueling.
- Do not store fuel in any containers or compartments which are not designated for fuel storage.
- Static electricity can be generated while fueling and can cause a fire or explosion. To prevent electrostatic spark when refueling, make sure the nozzle is in contact with the fill pipe at all times.
- Avoid damaging fuel lines and connectors and make sure fuel does not contact hot engine parts.
- Do not confuse the fuel fill deck plate with the water or waste fill plates, if equipped. All deck plates are properly labeled. If fuel is accidentally pumped into any other deck plate, do not attempt to pump it out. Water and waste pumps are not designed to pump fuel and a fire or explosion could result. Contact the dealer to have the fuel professionally removed.
- USCG-approved fire extinguishers are required on all Class I, II and III boats.



A fire or explosion may occur when least expected. The decision to abandon the boat or stay to fight the fire is difficult and depends on many factors. Formulate a fire plan in advance to make that decision quickly and without hesitation. Keep in mind the following guidelines:

- Many fires are the result of gasoline and oil accumulating in the bilge, careless fueling practices and electrical problems. In the event of a fire, try to stop the boat and turn off the engine as quickly and safely as possible. Immediately use a fire extinguisher at the base of the flames in a sweeping motion to reduce or extinguish the fire. Ensure that all passengers are safe from immediate danger and are wearing life jackets. If the fire is located in the engine compartment (if equipped), make sure the bilge blower (if equipped) is off and do not open the engine cover.
- Once the fire is extinguished, check for other immediate fire threats and personal injuries and call for assistance immediately.
- If you are unable to easily extinguish the fire, or if the fire is uncontrollable, attempt to get yourself and all passengers off the boat and into the water. If possible, ensure that all passengers are wearing life jackets or have access to one by the time they are in the water. Before leaving the boat, if possible, verify that there is no immediate danger of fuel sitting or burning on the water's surface where you and your passengers will be floating. Immediately swim to a safe position upwind from the boat and use distress signals to get assistance.

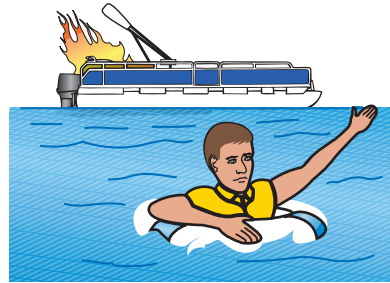

KC-0075C-A

MAN OVERBOARD (MOB)

A high percentage of boating fatalities are the result of people falling overboard, many of whom were not wearing life jackets. If someone falls into the water unexpectedly, react quickly, as every second counts toward preventing injury or death. Keep these guidelines in mind:

- Brief passengers before leaving the dock on the proper procedures should someone fall overboard. Add this briefing to the passenger safety equipment overview.
- At the first sign that a person has fallen overboard, loudly yell “man overboard” and state which side of the boat such as “man overboard—port!” In heavy seas, throw a floatable item toward the MOB as quickly as possible to serve as a marker.



- The operator should immediately reduce speed and determine whether or not to come to a full stop or circle around.
 - If stopped, throw a flotation device (Type IV is best, but any can be used) to the victim, shut down the engines, and throw the victim a line if necessary.
 - If circling around, assign one passenger to throw a flotation device as a marker, keep the victim in sight and continuously point to the victim. Carefully navigate back to the victim, staying at a safe distance, and position the boat safely to retrieve the victim. Keep current, wind and waves in mind so the victim drifts toward the boat. Shut down the engines and throw the victim a line if necessary.
- Move passengers to the rescue side of the boat to assist the victim back into the boat.
- Avoid going into the water to assist the victim unless there is no other way to retrieve the victim. If a rescuer must go into the water, the rescuer should be wearing a life jacket. The rescuer should also be prepared for the possibility of being pulled under water by the victim if the victim is panicking.

CAPSIZING AND FLOODING

A boat may capsize or flood when least expected. Formulate a plan in advance in case of capsizing or flooding. Review the following guidelines:

- If the boat capsizes, locate all passengers and guide them to a safe flotation device or the forward hull if the boat is floating upside down.
- If possible, provide life jackets to all persons in the water and assess them for alertness and injuries.
- **STAY WITH THE BOAT!** Climb up on the hull and try to get assistance.
- Do not try to swim to shore, as it can be farther than it appears.

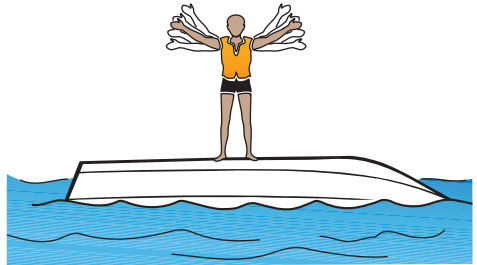

KC-0013C-A

If the boat starts to flood, slow the boat to a safe speed and stop as quickly as possible. Activate the bilge pump(s) immediately. Try to locate the cause of the flooding. If the cause is not readily apparent or not easily corrected, head for shore or shallow water as quickly as possible and call for help.



RUNNING AGROUND

When a boat runs aground, the stop is usually abrupt. Because passengers are not secured to a seat, abruptly stopping a boat while in motion can cause serious personal injury or even death. First, turn off the engine(s) immediately, locate all passengers and attend to any injuries, calling for emergency assistance as needed. Then, assess the damage to the boat and determine if there are any other immediate threats such as water leaking into the boat, or fuel or flammable materials leaking into the water or inside the boat. Immediately call for assistance if threats exist that could endanger the safety of passengers.

If there are no immediate safety threats to passengers and the boat is not damaged, attempt to propel it away from the obstacle. If the engine or drive system has been damaged and the engine restarts, be aware of excessive vibrations or uncommon noises, which usually indicate damage to the drive system. If this is the case, it is not safe to proceed. Call for emergency or professional towing assistance immediately.



WARNING *Personal Injury Hazard: DO NOT attach tow lines to cleats, watersport line point, or eyes used for docking; use only designated strong points. Death or serious injury could occur if lines and/or hardware fail while they are under extreme tension.*

If the engine restarts and the boat can be navigated safely back to port, proceed slowly to port and be ready to call for emergency assistance if needed. Even if the boat and engine appear to be in good operating condition after running aground, have the boat inspected by a qualified marine technician BEFORE returning it to service. Damage may have occurred that is not obvious to you as an operator.

DANGEROUS WEATHER

Take special precautions when encountering or operating in dangerous or hazardous weather conditions.

See the *Severe Weather* section of this manual for additional information.

ENGINE OR BOAT SYSTEM FAILURE

In the event of an engine or boat system failure and when not in immediate danger, try to troubleshoot or identify the problem before calling for assistance.

See the *Troubleshooting* section of this manual for additional information.



ACCIDENTS, COLLISIONS AND GIVING ASSISTANCE

A collision or accident may occur when least expected. Formulate a course of action in advance in case of a collision or accident. Keep in mind the following guidelines:

- If an accident or collision occurs involving the boat, locate all passengers first and verify and secure their safety. Check for injuries and provide all passengers with a flotation device.
- After determining that passengers are not in danger, provide assistance to passengers on the other boat.
- Immediately call for help and then assess the damage to the boats. Render necessary assistance to prevent further damage or personal injury.

The USCG requires the owner/operator of a boat involved in an accident to report the incident immediately to the proper marine law enforcement agency for the state in which the accident occurred.

See the *Reporting Accidents* section of this manual for additional information.

An operator who witnesses or is aware of an accident or collision while boating must report it immediately and provide assistance.

Operators seeing a distress signal or suspecting a boat is in trouble must assume it is a real emergency and render assistance immediately. After determining that a real emergency exists, call for help immediately and then provide assistance to all passengers to ensure their safety.

TOWING ON THE WATER

In situations where an operator is asked to tow or be towed for any reason, assess the situation and try to contact a professional towing service or other emergency assistance first. When encountering a boat in distress, always offer emergency or safety assistance and/or call for assistance for the distressed parties if necessary. Towing or being towed presents an increased risk of personal injury and boat damage.

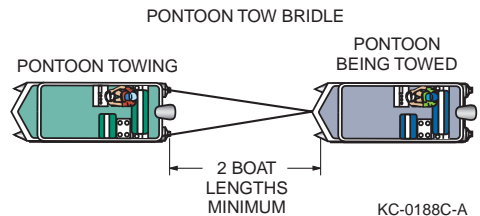

**WARNING**

Personal Injury Hazard: DO NOT attach tow lines to cleats, watersport line point, or eyes used for docking; use only designated strong points. Death or serious injury could occur if lines and/or hardware fail while they are under extreme tension.

Follow these guidelines when towing or being towed:

- Use extreme caution when throwing weighted lines to a boat in distress. When in rough seas, use a light throwing line with a weight secured on the throwing end and a heavier towing line secured to the other end.
- Never attempt to tow a boat larger or heavier than your own.
- Never attempt to tow a grounded, damaged or capsized boat.
- Use a tow line that is rated at least four times the gross weight of the boat being towed.
- Make sure tow lines are in good condition and are free of damage, cuts or abrasions.
- Attach a tow line to the designated strong point on the disabled boat. Never attach a tow line to any point on the disabled boat other than the designated strong point. Strong points are typically the bow and stern eyes on boats under 26' and are usually labeled.
- When attaching to the stern strong points, wrap the tow line with chafing gear where it rubs against the boat or any corners.
- Leave at least two boat lengths between the boats for adequate movement.
- Never allow anyone to be in line with the tow line. If the line breaks, pulls free or the hardware fails, dangerous recoil could occur, resulting in severe injury or death to anyone in its path.
- Adjust the tow line to match wave action. Keep the boats on the crest or in the trough of the waves at the same time. In protected, calm waters, shorten the line for better handling.
- Tow at moderate speed, allowing for adverse wind and wave conditions.
- Have the operator of the towed boat steer with you if possible.
- Have a person on the tow boat watch the disabled vehicle and, if necessary, be available to signal the operator of the disabled boat.

Check with local and state authorities prior to towing for additional regulations and restrictions on towing other boats or equipment.



HURRICANE AND SEVERE WEATHER PREPAREDNESS

If keeping the boat in a region susceptible to hurricanes or severe weather (such as in the Great Lakes), have a well-thought-out plan for the boat long before the season starts. Consider the following:

- Boaters new to the area should talk to neighbors and local officials on what to expect.
- Boaters should talk to the dealer and marina about supplies, equipment and services available.
- Assemble the boat, contacts and insurance information and copy documents for safekeeping.
- If keeping the boat on the water, prepare a hurricane mooring package with extra lines, fenders and chafing protectors, as it is usually the boat owner's responsibility to provide mooring gear in a marina. Plan on doubling the normal lines (bow, stern and spring) and fenders as a minimum. Remember, once a hurricane watch is posted, the local supply of lines and fenders will be quickly depleted.
- Remove electronics, canvas and loose items such as fighting chairs.
- Remove flammable, explosive or hazardous materials.

PROTECTING THE BOAT FROM THEFT

Thefts of boats, propulsion units and electronics are on the rise due to the high values and easy resale. While thieves still target boats on trailers at homes or on lake properties, marinas, storage facilities and dealerships are now being targeted because of the concentration of high-quality outboards and electronics available. Consider the following to make it difficult for thieves:

- Remove expensive electronics or cover with a sturdy, lockable cover.
- Use locking devices on outboard motor mounts and propellers.
- Use security fasteners that require a special tool for removal when mounting devices.
- Survey the marina or storage facility for obvious security lapses. Discuss concerns with personnel or find a new location.
- Talk to neighbors at home or the marina/storage facility and provide them with a cell phone number and other contact information.
- If leaving the boat in the water, install a boat monitoring system with GPS tracking. Many propulsion unit manufacturers now offer this as an option on boats with electronic controls.
- Consult an insurance agent and local authorities for more recommendations.



SECTION

4

EMERGENCIES

This Page Intentionally Left Blank

Section 5

OPERATING IN HAZARDOUS CONDITIONS

Before operating the boat, review *Safety in Section 2*.

SEVERE WEATHER

Getting caught in severe weather can be dangerous and even fatal. Check with local weather stations, the USCG or weather-service broadcasts (162.55 or 162.40 MHz) for the latest conditions. Check the weather not only before you go out on the water, but also periodically while you are on the water. Consult the following websites for weather information:

- www.weather.com
- www.nws.noaa.gov
- www.navcen.uscg.gov

STORM CONDITIONS

Take the following precautions if operating the boat in storm conditions:

- Have all occupants wear life jackets.
- Turn on navigation lights.
- Locate and have inclement weather gear and safety equipment ready.
- Mark or identify the boat's position.
- Close all ports, stow all gear and secure any loose equipment on deck.
- Reduce speed and head for port or a safe, easily reachable place.
- Keep a lookout for debris and obstructions in the water.
- When possible, head into the waves at a 45-degree angle. Allowing high waves to strike the side of the boat may cause it to capsize or swamp.
- If losing power, keep the boat headed into the waves by rigging a sea anchor off the bow.
- If a storm cell with lightning cannot be avoided, lower antenna and take down fishing poles.



FOG CONDITIONS

Avoid operating the boat in foggy weather, if possible. Operators encountering fog conditions should return to port immediately. Also, take the following precautions:

- Reduce speed to a safe speed or idle.
- Take bearings and log the course and speed before the fog sets in. Use of a GPS is recommended.
- Have all occupants wear life jackets.
- Assign lookouts to the bow and stern to keep watch and listen.
- While navigating in fog, sound a five-second blast from the horn or whistle once every two minutes to alert other boaters of your position.
- If it is unsafe to continue navigating the boat, quickly find the best position to anchor. Sound a five-second blast from the horn or whistle once every minute while anchored to alert other boaters of your position.

REDUCED VISIBILITY

Natural environments and inclement weather can cause reduced visibility. Storm condition hazards can be compounded by reduced visibility while on the water. Always use common sense and take safety precautions if operating the boat in reduced visibility conditions.

COLD WEATHER AND COLD OR FROZEN WATER CONDITIONS

Avoid operating the boat in cold water or weather conditions, and never operate in frozen or icy waters. Operating in these conditions significantly increases the risk of serious injury or death. Boating in these conditions can lead to cold-water immersion, shock or hypothermia. Weather conditions may hinder emergency rescue or assistance, and cold weather poses potential problems for onboard equipment, as well as the engine. See the *Engine Operator's Manual* and the equipment manufacturer's instructions for operating in cold weather.

WATER HAZARDS

Every waterway poses hazards that operators must be aware of and avoid. These hazards include shallow water, rocks, tree stumps, sandbars and submerged/semi-submerged cables and pipes. Ask local authorities and other boaters for information and consult a marine chart when boating on unfamiliar waters. As a boat operator, try to avoid all hazards, known and unknown.



AQUATIC VEGETATION/WEEDS

Operating in weeded areas can be hazardous. Aquatic vegetation can be a threat to the boat's drive system. Vegetation and weeds can wrap around the propeller, causing loss of propulsion and steering control. They may also restrict the engine water cooling intake, causing the engine to overheat. Avoid operating in or near vegetation. If restricted because of vegetation, stop the engine. See the *Engine Operator's Manual* for recommendations on the removal of vegetation from the propeller and water cooling intake ports. Be extremely careful and never get into the water when clearing the propeller. Stay out of the water in highly congested vegetative areas, which can severely restrict your mobility and create a life-threatening situation.

NOTICE

Vegetation can sometimes be removed by shifting to NEUTRAL, pausing a moment, then shifting to REVERSE to unwind the vegetation from the propeller.

DAMS AND SPILLWAYS

The waterways around dams and spillways are extremely hazardous. Dams and spillways are subject to rapid water flow changes, and may have floating and sunken debris in the nearby water. These areas are often marked as restricted, and it is best to always stay clear of them.

SHALLOW WATER OPERATION



WARNING

Collision Hazard: Use caution in shallow water or where underwater/floating objects may be present. Hitting an object at high speed or severe angle can seriously injure people and damage the boat.

Operating in shallow water presents a number of hazards. Sandbars in narrow inlets are constantly shifting, making it difficult to mark them with buoys. Sandbars are sometimes indicated by waves as they form into breakers when passing over the sandbar. In coastal areas, tides can affect water level as much as 30 feet (9 meters). Check with local marinas or Coast Guard stations for tide tables and current charts.



MARKERS, WARNINGS AND ADVISORIES

Find out from local authorities if hazards exist in areas where you intend to navigate, and know how these hazards are marked. You must also recognize flag designs that indicate hazards or activities that are present and keep well clear of those areas. Always watch for swimmers and stay clear of all swimming areas, marked or unmarked.



KC-0015C-B

Become familiar with navigation markers, which identify navigable routes and indicate water hazards. Always stay within marked boundaries and steer clear of hazards.

Flags and indicators are markers of potential emergencies and hazards. Become familiar with these flags and indicators. Additionally, understand your responsibilities when operating at these times and in these areas.

BOAT FLAGS

DIVERS FLAG



USED BY
RECREATIONAL
DIVERS -
INDICATES
DIVER'S
POSITION

ALPHA FLAG



WORLDWIDE VESSELS
ENGAGED IN DIVING
OPERATIONS - DOES
NOT INDICATE
DIVER'S POSITION

DISTRESS FLAG



INDICATES
FELLOW
BOATER IS IN
NEED OF
ASSISTANCE

SKIER DOWN FLAG









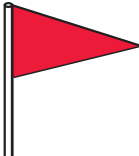

INDICATES
SKIERS IS DOWN

KCB-0013

Storm warning advisory flags and indicators alert boaters to impending weather conditions. Become familiar with these flags and indicators and understand the potential hazards associated with operating in these conditions.



HARBOR FLAGS AND INDICATORS

DAYTIME WARNING	DESCRIPTION	NIGHTTIME WARNING
	Small Craft Advisory - Winds greater than 18 knots, sustained for two hours or more or hazardous wave conditions. Following a storm, hazardous wave conditions can persist long after the high winds have subsided.	
	Gale Warning - Sustained winds (2 or more hours), of 34-47 knots.	
	Storm Warning - Sustained winds of 48 knots or greater.	
	Hurricane Warning - Forecast winds of 64 knots and above. Displayed only in connection with a hurricane.	

 Actual Signal in red

KC-0371C



SECTION

5

OPERATING IN HAZARDOUS CONDITIONS

This Page Intentionally Left Blank

Section 6

NAVIGATION RULES AND AIDS

Before operating the boat, review *Safety in Section 2*.

The following information outlines basic navigational rules. Boating regulations are enforced by USCG, state and local authorities. You are subject to marine navigation regulations for both federal and state waterways. For more information, contact the USCG, state and local marine authorities. The navigational rules for U.S. waterways can be found in the “Navigational Rules” publication. This publication can be found at most marine supply stores, or you may contact the USCG or visit:

www.navcen.uscg.gov to view or download the publication.

Any boat 39 feet (12 meters) or longer must have a copy of the “Navigational Rules” publication on board at all times. Failure to have this document on board can result in penalties and/or fines.

RIGHT-OF-WAY

Boats with less maneuverability have right-of-way over more agile boats. You must stay clear of a boat with right-of-way. Examples of boats with right-of-way are:

- Boats aground or not under command
- Boats with restricted maneuverability
- Boats engaged in fishing
- Non-motor boats (having no power propulsion), i.e., rowboats, paddle boats, canoes and sailboats

Small pleasure boats must yield right-of-way to large commercial boats in narrow channels. A boat with right-of-way is sometimes referred to as the privileged boat.

THE GENERAL PRUDENTIAL RULE

The general prudential rule regarding right-of-way is if a collision appears unavoidable, neither boat has right-of-way. Both boats must act to avoid collision.



NAVIGATIONAL LIGHTS AND NIGHT OPERATION

Navigational lights are intended to alert other boats to your presence and course and their use is essential to boating safety and the prevention of collisions. Knowledge of navigation lights is necessary for the boat operator.

Regulations require that navigational lights be clearly lit and properly displayed at all times between sunset and sunrise, and always when operating in reduced visibility. Where applicable, lights must appear on the sides, stern, masthead and all-around positions.

All navigational rules apply at night, but speed is restricted on many waterways. Night boaters must operate at a slow, safe speed and stay clear of all boats, regardless of which boat has right-of-way.

Protect your night vision by avoiding bright lights. If possible, have a passenger help keep watch for other boats, water hazards, and aids to navigation.

The size, speed and direction of other boats are determined at night by white, green and red running lights.

- A green light indicates the starboard side of the boat. Generally, if you see a green light on another boat, you have the right-of-way. Hold your course.
- A red light indicates the port side of the boat. Generally, if you see a red light on another boat, they have right-of-way and you must yield your course.
- If you see both red and green lights, this indicates the boat is pointed towards you. Reduce speed and give a wide berth, usually on your port.
- A white light alone with no visible red or green lights indicates a boat at anchor and not making headway or a non-powered craft. Reduce speed and give a wide berth.

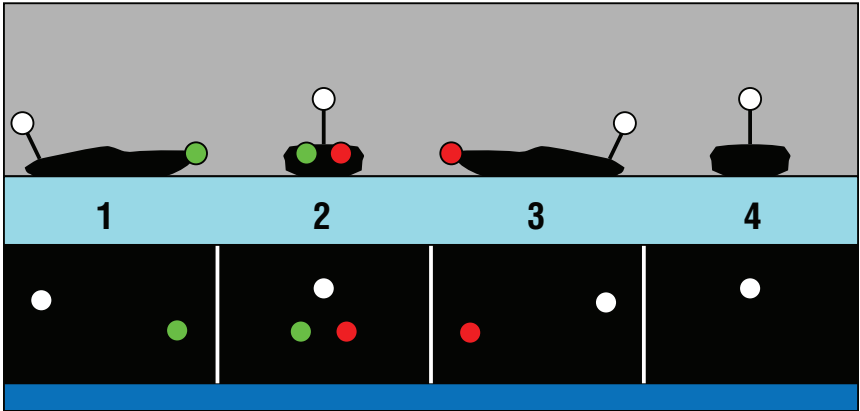

KCB-0104

1. Starboard Side; boat moving to the right
2. Bow; boat moving towards you
3. Port Side; boat moving to the left
4. Stern; boat anchored, non-powered or moving away

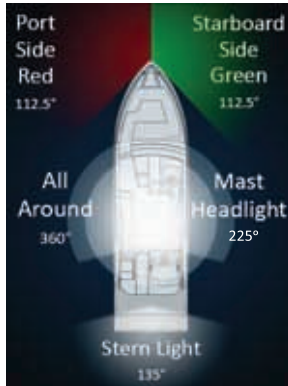

KCB-0105



AUDIBLE SIGNALS

It is not necessary to sound a signal every time a boat is nearby. It is typical for commercial boat operators to signal their intention, using a whistle, horn or bell, to avoid potentially confusing or hazardous situations. Privileged boat operators customarily signal first, then the yielding boat operators return the same signal to acknowledge they understand and will comply. Use the danger signal (five or more short, rapid blasts) if intent is not clear.

Use the following signal blasts early enough so other boaters notice and understand them:

AUDIBLE DISTRESS SIGNAL	DEFINITION
One long blast	Warning signal (coming out of slip or passing astern)
One short blast	Pass on port side
Two short blasts	Pass on starboard side
Three short blasts	Engine(s) in reverse
Five or more short blasts	Danger signal



OVERTAKING / PASSING

The boat overtaking or passing must yield right-of-way to the boat being passed. The overtaking boat must make any adjustments necessary to keep out of the way of the boat being passed. The boat being passed has the right-of-way and must hold its course and speed.

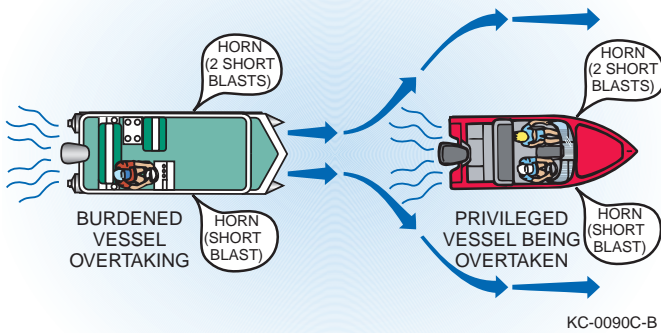



MEETING HEAD-ON

When two boats meet head-on, neither boat has the right-of-way. Both boats should decrease speed, turn to the right and pass port to port. If, however, both boats are on the left side of a channel, each vessel should sound two short horn blasts and pass starboard to starboard.

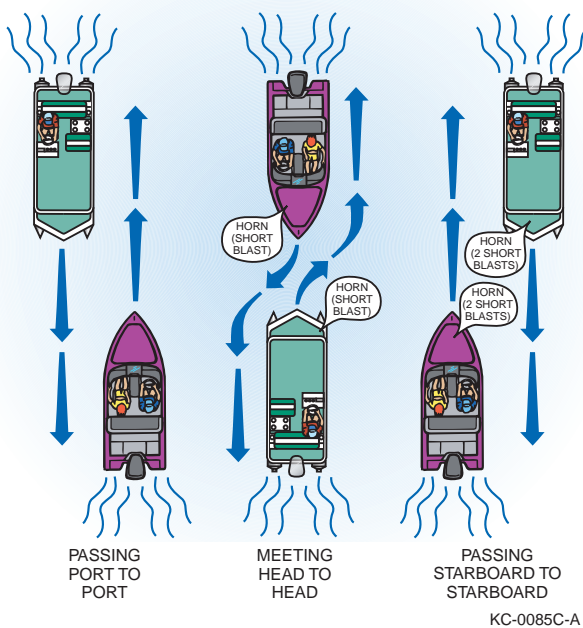



CROSSING

In crossing situations, the boat to the right from the 12 o'clock to the 4 o'clock position has the right-of-way and must hold course and speed. The boat without right-of-way must yield and pass to the stern of the privileged boat. Boats going up and down a river have the right-of-way over boats crossing the river.

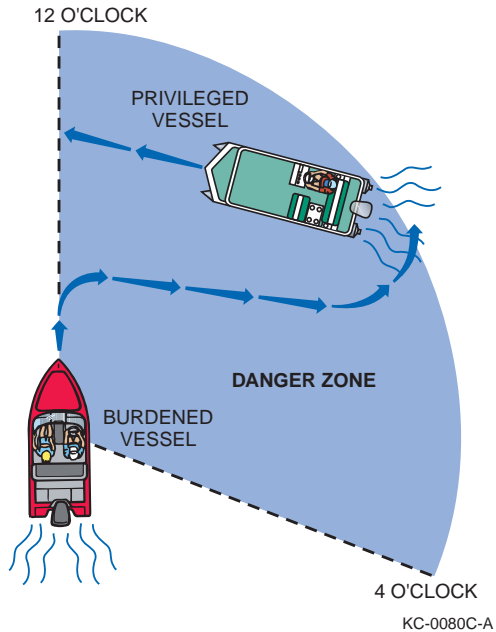

AIDS TO NAVIGATION

Learn to recognize the different buoys and day markers; they are the signposts of the waterways. The United States Aids to Navigation System (USATONS) is the primary marking system used on inland water, coastal waters and rivers. This system is maintained by the USCG.

There are two other navigation marking system variations boaters must follow in the United States:

- Western Rivers Marking System – When on the Mississippi River, tributaries above Baton Rouge, and several other rivers that flow toward the Gulf of Mexico.
- Intracoastal Waterway (ICW) – Runs just inland and parallel to the Atlantic Ocean and Gulf coasts from Manasquan, New Jersey, to the Mexican border. *Since ICW routes may travel next to non-ICW routes in opposing directions, navigate by the yellow symbols when following the ICW.*

Both systems are similar to USATONS but have subtle differences that must be understood. If you boat in these areas, visit www.uscgboating.org for navigation rules.

Navigational aids are designed and placed accordingly to help you navigate safely on the water. Learn to recognize the different buoys and day markers.

The following information is based on the USATONS. For further information, contact the USCG and state and local marine authorities. Also visit www.uscg.boating.org for navigation rules.

The USATONS uses buoys, beacons and minor lights as markers.

NEVER tie or anchor to a navigational aid. This action is unlawful and dangerous to you, your boat and other boaters.

NEVER move or damage a navigational aid. This action is unlawful and dangerous for other boaters.

BUOYS

Most anchored floating markers are generally referred to as buoys. Buoys have many uses and color schemes, and can vary in size and shape. The most commonly used buoy colors are white, red, green, yellow and black. Buoys may be unlighted or lighted. Some are audible; others have both an audible and a visual signal. Lights, bells and horns on buoys aid in night boating or poor visibility conditions. Buoys with unique light-flashing characteristics are identified on nautical charts with the specific flashing pattern.



Become familiar with the specific buoys used in the waters where you are boating. Contact local authorities for specific information and/or navigational aid charts for your waterways.

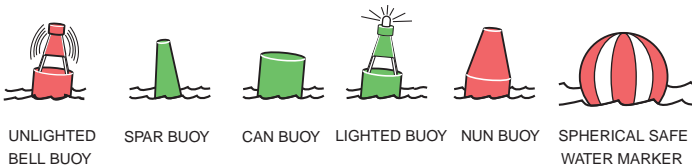

UNLIGHTED
BELL BUOY

SPAR BUOY

CAN BUOY

LIGHTED BUOY

NUN BUOY

SPHERICAL SAFE
WATER MARKER

KC-0052C-B

MOORING BUOYS

The only buoys you are permitted to moor to are mooring buoys. Mooring buoys are white with a blue horizontal stripe. Mooring to a navigation buoy, regulatory markers or lateral markers is illegal.



WHITE WITH BLUE BAND
MAY SHOW WHITE
REFLECTOR OR LIGHT

KC-0020C-A

DAYMARKS / DAYBOARDS

Daymarks or dayboards are fixed visual markers in the water. The markers are commonly attached to a post or piling and are sometimes accompanied by a light. Daymarks are either red or green and are usually triangular- or square-shaped, though their shapes can vary. Daymarks often display numbers, which act as navigation guides. Red daymarks are usually triangular and sometimes show an odd number. Green daymarks are usually square and sometimes show an even number. The numbers on the markers are sequential and increase from seaward.



STARBOARD
DAY
MARKER



PORT
DAY
MARKER

KC-0021C-A



LIGHTS AND LIGHTED STRUCTURES

Maneuvering a boat at night can be dangerous and confusing. To aid boaters with navigation and to warn of hazards, the USCG and state and local authorities maintain a variety of light structures. Some light structures are equipped with radio beacons, radar reflectors and/or fog signals.

Minor Lights

Minor lights are colored according to the buoyage marking system in use. They are similar to lighted buoys, except they are usually higher and on more stable platforms to increase visibility. Most minor lights are part of a series to mark a channel, river, or harbor and fairways.

Range Lights

Range lights are usually visible in one direction and help a boat operator navigate safely. Steering a course to keep range lights arranged in a line (one on top of the other) will help guide a boat through a channel.

RANGE LIGHTS

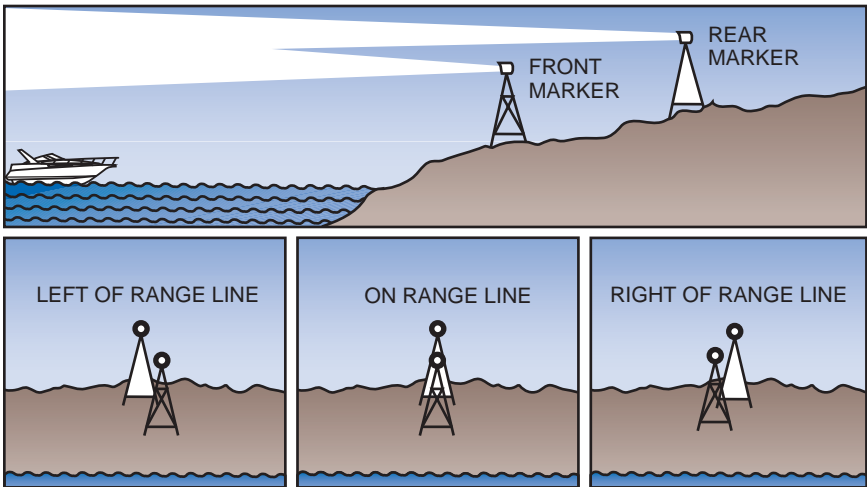

KC-0022C-A



Lighthouses

Lighthouses can be found at harbor entrances, prominent headlands, isolated danger areas and along the coasts. These striped or patterned structures have unique flashing signals, which help boaters identify them.

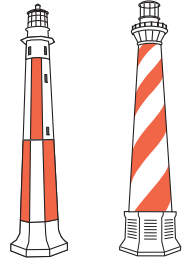

KC-0023C-B

MARKERS

Seven (7) types of markers are used to assist the boat operator:

- Regulatory
- Range
- Special
- Lateral
- Safe Water
- Preferred Channel
- Isolated Danger

Regulatory Markers

Regulatory markers are used to display information or indicate danger. Regulatory markers can be fixed visual markers or anchored floating buoys.

Fixed visual markers are usually white with orange geometric shapes that display information. Anchored floating buoys are white cylinder-shaped buoys with orange bands at the top and orange geometric shapes that may display information.

Following are the various orange geometric shapes used on these markers:

- Diamond – Indicates danger
- Diamond with cross marks inside – Indicates that a boater must keep away
- Circle – Indicates a controlled area or speed limit
- Square – Displays important information



DANGER



BOATS
KEEP OUT



CONTROLLED
AREA



INFORMATION

KC-0244C-A



Range Markers

Range markers have many color schemes, may have numbers or letters and may be lighted or unlighted. They are placed in pairs within close distance of each other. They are commonly used in channels to guide boats safely through the center or safe line of navigation. Keep range markers visually in line with each other while navigating the waterway to avoid obstacles or other invisible dangers.

Special Markers

Special markers are yellow and come in various styles and shapes. Lighted and unlighted daymarks and buoys vary in function. Many are used to display information and navigational direction rules. The most common special markers are those used in intercoastal waterways. Contact your state and local authorities for more information on special markers used in your boating area.

Lateral Markers

Lateral markers are used to mark the sides of navigable channels. They can be buoys, daymarks or minor lights, and are red and green in color. They can be lighted or unlighted and may or may not have numbers.

The basic nautical rule of lateral markers is the phrase “Red, Right, Returning.”

The term “sea” generally refers to the ocean or a large body of water. “Seaward” refers to traveling from the sea or a large body of water inland or to a smaller body of water.

When traveling seaward – keep red markers to your port (left) and green markers to your starboard (right).

When returning from seaward – keep red markers to your starboard (right) and green markers to your port (left).

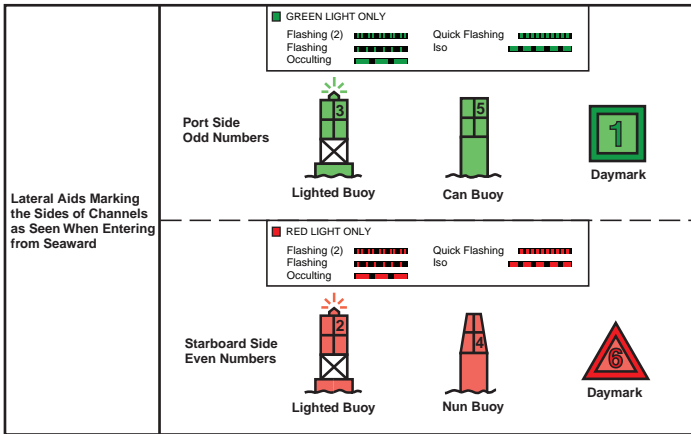

KC-0054C-A

Safe Water Markers

Fairways and mid-channels may be marked with safe water markers or buoys. These markers indicate safe water all around. Safe water markers are red and white with vertical stripes, and are round or have a red spherical top mark.

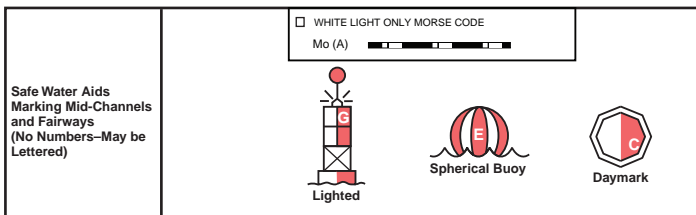

KC-0055C-A

Other Special Signs and Markers

Various signs and markers are used throughout U.S. waterways for different purposes. In Florida, special signs are used to warn of “manatee” areas. These signs help to control speed and/or restrict areas from boating to conserve this endangered species. As a boat owner and operator, be aware of special information and markers on the waterways. Contact your state and local authorities for more information on local restricted or controlled areas and their markers.



Preferred Channel Markers

Obstructions, channel junctions and preferred channels are marked with red and green horizontally striped can and nun-style buoys. The top band color indicates the preferred path to take. Use these markers in the same manner as lateral markers to follow preferred channels.

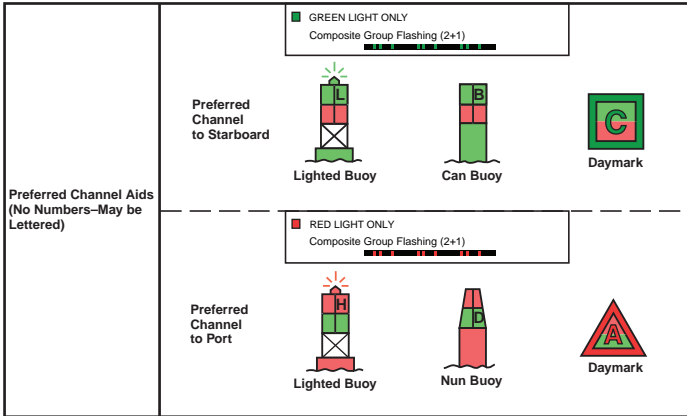

KC-0056C-A

Isolated Danger Markers

Isolated danger markers indicate an isolated danger which may be passed on all sides. These markers are black with one or more broad horizontal red bands and are equipped with a top mark of two black spheres, one above the other. On inland waters, a buoy with alternating vertical black and white stripes may be used to indicate that an obstruction or other danger exists between the buoy and the nearest shore. Do not pass between the buoy and the shore.

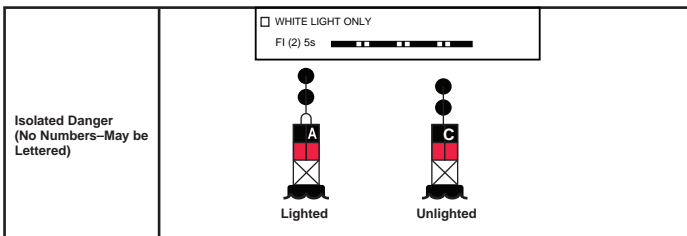

KC-0057C-A

Section 7

OPERATING THE BOAT

Before operating the boat, review *Safety in Section 2*.



WARNING

Control Hazard: Certain actions can cause you to lose control of the boat:

- *When accelerating the boat in the forward direction, the bow can rise and restrict visibility. Observe for obstacles and people before accelerating.*
- *The rotational thrust of the propeller under rapid acceleration can create high steering torque and rapidly change the direction of steering, causing loss of control.*
- *Do not trim the engine out too far or the boat may begin to “porpoise” (bounce up and down). Porpoising reduces control and visibility.*
- *Improper use of trim tabs or moving them down at high speeds can cause loss of control.*
- *If you lose control of the boat, pull back on the throttle and trim in at the same time.*

BEFORE GETTING UNDERWAY

SAFETY EQUIPMENT

Federal and local laws require certain safety equipment to be on board at all times. Responsible boaters carry additional equipment in case of emergency.

FLOAT PLAN

Complete a float plan before departure and leave it with a reliable person who is aware of your intentions while on the water. In case of emergency or if you do not return as planned, this information can be helpful to the USCG or others in rescuing or contacting you. There are several float plan apps that make it easy to fill out and email the plan. For more information on float plans or to download a float plan form, go to:

<http://www.floatplan.uscgaux.info>



PRE-DEPARTURE SAFETY CHECKLIST

The following checks are essential to safe boating and must be performed before starting the engine or getting underway. Perform these checks every time you operate the boat so they become routine.

Never launch the boat or leave the safety of the dock if any problem is found during the pre-departure safety check. A problem could lead to an accident during the outing, causing severe injury or death. Have any problems corrected before proceeding:

- Check the current and forecasted weather reports, as well as wind and water conditions.
- Make sure the operator is qualified to operate the boat and does not use drugs or alcohol while at the helm.
- Review the Boater's Check List located next to the helm.
- Make sure all required safety equipment is on board.
- Make all passengers aware of safety procedures and review the safety labels.
- File a float plan.
- Have all required documents on board.
- Have all maps or navigational charts for the intended destination on board.
- Be sure all passengers are properly seated.
- Be sure the boat is not overloaded.
- Check the engine emergency stop switch lanyard for proper installation and operation.
- Be sure the fire extinguisher is fully charged.
- Check bilge drain plugs for proper installation.
- Be sure all water has been pumped from the bilge area.
- Have plenty of emergency food and water on board.
- Check the bilge blower (if equipped) for proper operation, and be sure no fumes are present in the bilge area.
- Be sure the bilge pumps are operating properly.
- Be sure all required equipment is on board (mooring lines, anchor lines, tool kit, etc.).
- Be sure you have enough fuel for the return trip.
- Check all compartments for fuel fumes.
- Check that no fuel, oil or water is leaking or has leaked into the bilge compartment.
- Check all hoses and connections for leakage and damage.
- Check the hull and propeller for damage.



- Check the engine cooling water intake pickup for blockage.
- Check that batteries are fully charged and the battery terminals are clean and tight.
- Check the electrical systems and navigation lights for proper operation.
- Be sure no person or obstacle is near the propeller.
- Check that the throttle/shift control is in the NEUTRAL position.
- Check the steering system for proper operation.
- Inspect the steering, throttle and shift cables for kinks, wear and interference with other components.
- Check that all required maintenance has been performed.

BOARDING

Helpful guidelines when boarding a boat:

- Always step, rather than jump, into a boat.
- Be careful when wearing flip-flops.
- Avoid stepping on fiberglass or other potentially slippery surfaces.
- Always board one person at a time.
- Never board while carrying gear. Set the gear on the dock, board the boat and then pick up the gear.
- Never use the engine unit as a boarding ramp.
- It is courteous to always ask for permission to board so the owner/operator is aware of your presence on the boat.

See the *Using the Boarding Platform/Ladder* section of this manual for re-boarding the boat from the water.

BOAT LOADING

The safety and performance of the boat depends on load, weight and the distribution of each.

The person/load capacity is determined by the USCG. A capacity plate is usually located within clear visibility of the boat operator or helm area. The capacity plate indicates limits for loading the boat, which are enforceable by law.



OPERATING THE BOAT

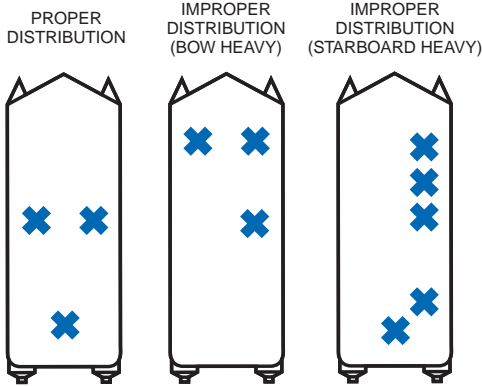

KC-0336-A

**WARNING**

Sinking Hazard: NEVER exceed the USCG certified maximum capacities under any circumstances. Exceeding the limitations stated on the capacity plate can cause the boat to sink or the passengers and/or operator to drown, resulting in death or serious injury.

- Board passengers one at a time and distribute them equally to maintain equal buoyancy of the boat.
- Distribute weight equally from port to starboard and fore to aft. The shifting of weight may be required when underway to maintain an efficient trim position for optimum performance.
- Do not allow passengers to obstruct the captain's line of sight during operation.
- Stow and secure all loose gear in stowage areas to prevent load shifting.
- Do not stow gear on top of safety equipment; safety equipment must be quickly accessible.
- In adverse weather, reduce the load in the boat. Person and load capacity ratings are calculated for normal boating conditions.



FUELING

FUEL MANAGEMENT

Use the “one-third” rule for fuel management. Use one-third of the fuel to reach your destination, one-third to return and one-third as reserve fuel.

FUEL SUPPLIERS

Refuel only at approved suppliers such as marina fuel docks or automotive fuel service stations. Approved suppliers have safeguards in place to lessen the likelihood of static discharge. Use only containers and funnels approved for use with gasoline fuels. See the *Before Refueling* section of this manual for additional information.

STATIC ELECTRICITY AND THE FUEL SYSTEM

The boat’s built-in fuel tank has a bonding system that protects it from creating and discharging static electricity. The boat must be in contact with the water or on its trailer when refueling to complete the bonding system.

If the bonding system is not complete, an electrostatic spark may occur.



WARNING

Fire/Explosion Hazard: An electrostatic spark can ignite fuel vapors, causing a fire and/or explosion.

Use extreme caution when filling the fuel system. In addition:

- Remove portable fuel tanks from the boat and place them on the ground to fill. The fuel tank must be properly grounded before refueling.
- Do not refuel a built-in fuel tank if the boat is suspended from a sling or another type of boat lift system. Suspending the boat from the water interrupts its bonding system. Using a portable fuel tank to refuel the boat while it is suspended may cause an electrostatic spark.



FUEL (GASOLINE)

Fuel for marine gasoline-only engines must be carefully selected to avoid fines and possible catastrophic engine damage not covered under warranty. It is illegal for any person to tamper with emissions control devices such as the fuel system, and it is also illegal for any person to mis-fuel a marine gasoline-only engine with a blend of more than 10% ethanol.

While it is always preferable to use fuel that does not contain ethanol (usually labeled as “marine” or “recreational”), most marine engines are designed to tolerate E10 (10% maximum ethanol) fuel as long as the fuel meets the engine manufacturer’s octane requirements. When using fuel containing ethanol, buy fuel in smaller quantities that will be consumed during a weekend of boating. Fuel degrades quickly and the engine operates better on fresh fuel. Use marine fuel stabilizer to treat and reduce degradation of any remaining fuel.

Fuels that contain bio-isobutanol at any percentage are safe to use in marine products and have none of the limitations of ethanol biofuel additives.

Do not use octane boosters or other fuel additives except NMMA certified fuel stabilizer. Purchase fuel from a quality supplier selling high volumes to ensure the fuel is fresh. For more information go to: www.toptiergas.com/licensedbrands/

NOTICE

Fuels that are blended to contain more than 10% ethanol may damage the engine, oil system or fuel system and should not be used in marine engines. Fuels that contain more than 10% ethanol can corrode metal parts, deteriorate rubber and plastic, or weaken gaskets. Damages caused by the use of fuels that contain more than 10% ethanol or fuels that do not meet engine manufacturer octane requirements are not covered by your warranty.



KCB-0004



KCB-0005



Gasoline Fuel in the U.S. Market

The majority of recreational boats are trailerable and often fueled at automobile gasoline filling stations. In the U.S. market, there are ever-increasing percentages of ethanol blended with gasoline with the most common being 10%. Since there is no standard for labeling gas pumps, it can be confusing to select the proper blend – LOOK BEFORE YOU PUMP!

Ethanol blends of more than 10% are tempting to use in your boat because they are cheaper. Ethanol blends of more than 10% are NOT meant for ANY outdoor power equipment and their illegal use will not only deteriorate rubber and plastic, causing an environmental hazard, but will cause permanent DAMAGE to the engine that is not covered by the Warranty – DO NOT BUY GAS BY PRICE!

	CONTAINS NO ETHANOL	UP TO 10% ETHANOL	UP TO 15% ETHANOL	UP TO 30% ETHANOL	UP TO 50% ETHANOL	UP TO 85% ETHANOL
OK for Boat Engines	Yes	Yes**	No	No	No	No
OK for Long-Term* Storage	Yes*	No	No	No	No	No
Covered by Engine Warranty	Yes	Yes	No	No	No	No
Illegal to Use in Boat Engines	No	No	Yes	Yes	Yes	Yes
Price	Most Expensive	About 5% less	About 10% less	About 20% less	About 30% less	Least Expensive

* 3 – 6 months with NMMA certified marine-grade fuel stabilizer *added immediately*

** Not more than one month with marine-grade fuel stabilizer *added immediately*



BEFORE REFUELING

WARNING *Fire/Explosion Hazard: Gasoline is extremely flammable and highly explosive under certain conditions. Be sure to check the fuel hoses and connectors for leaking and deterioration before fueling and on a monthly basis.*

- Refuel the tanks only in a well-lighted area.
- Know where the fire extinguishers are.
- Stop all engines, motors, blowers and appliances before refueling.
- Do not smoke or allow open flames or sparks nearby, within 50 feet (15 meters), of the fueling area.
- If equipped, close all doors, windows, hatches and ports.
- Determine the amount of fuel required to fill the tanks. Do not overfill the fuel tanks. Allow for at least a 2% expansion of fuel when refueling. If the fuel temperature is 32°F (0°C) or lower, allow at least 6% for fuel expansion.

FUELING

The fuel filler on boats with built-in tanks is usually located on the gunwale or aft area. The fuel tank is equipped with either a shutoff valve or antisiphon valve. The shutoff valve requires you to manually turn the fuel valve, while the antisiphon valve operates automatically. Because gasoline fumes are heavier than air, they will sink to the lowest part of your boat, such as the bilge. Always evacuate fumes with the bilge blower (if equipped) before attempting to start the engine.

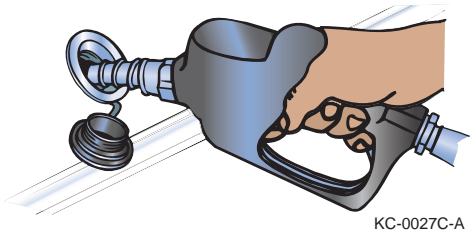

KC-0027C-A

NOTICE

To prevent unwarranted engine damage, refer to the Engine Operator's Manual for recommended fuel and oil specifications.



CAUTION

The fuel tank may be under pressure. Remove fuel filler cap slowly to release any pressure.



REFUELING BUILT-IN FUEL TANKS

Maintain contact between the fuel nozzle and the fill pipe at all times, before and during refueling, to prevent an electrostatic spark. If it's necessary to use a funnel, use a metal funnel. Do not use a plastic funnel. Do not fill built-in tanks from unapproved portable containers.

NOTICE

If the boat is unlikely to be used for two weeks or more, and you are using an ethanol-blended fuel, fill only the amount of fuel you need plus 15% as a safety factor. Unused ethanol-blended fuel deteriorates quickly.

AFTER REFUELING

- Close the fuel fill cap thoroughly.
- Wipe up any spilled fuel completely. Dispose of rags properly onshore.
- Open all doors, windows, hatches and ports to ventilate all spaces. Check for fuel vapors before starting any engines or appliances.
- If equipped, operate the blower for a minimum of four minutes before starting the engine.

OUTBOARD ENGINE FUELING CONSIDERATIONS

If the boat is powered with an outboard engine, one or more of the following may also apply:

- Smaller two or four-stroke outboards may have a portable fuel tank. If so, the tank must be removed from the boat and placed on the ground to be filled. Fill portable fuel tanks onshore in the outdoors within an enclosed area.
- After refueling, install portable fuel tanks to the boat using straps or other fuel tank restraining system. Store portable fuel tanks in a well-ventilated area, away from heat and open flames. If equipped, close the filler cap vent screw.
- Two-stroke outboards mix oil with the fuel to be burned during combustion. During fueling and refilling on a two-stroke outboard, check the separate oil tank inside the boat or under the engine cover.
- Two-stroke outboard oil must meet the engine manufacturer's specification.



GETTING UNDERWAY

The following basic boat maneuvering and operation principles do not cover all conditions or situations you may encounter during operation. It is important for you and anyone else operating the boat to have certified instruction before operating the boat.

Always advise all passengers on board of your steering, stopping and accelerating intentions. Brief passengers on:

- Obeying captain's orders
- Safety equipment location and operation
- Basic boat operation
- Radio operation
- Re-boarding procedure
- Man overboard procedure
- Emergency procedure
- Hazardous weather procedure
- Docking procedure
- Fueling procedure

Be sure all passengers are properly seated in designated seating positions and not riding on the bow, bow pulpit, deck, gunwale or rear sun deck while underway. Passengers must use caution when riding in the bow. Move to the aft passenger seats during rough water operation or if visibility is restricted.

STARTING

The following information is intended as a basic guideline only and may not apply to your specific engine or controls. See the *Engine Operator's Manual* or control manufacturer's information for instructions on starting and operating the engine, adjustments and maintenance.

- Secure the boat to the dock before starting the engine.
- Check that the throttle is in the NEUTRAL position.
- Turn the battery selector switch to the appropriate ON position.
- Operate the bilge blower (if equipped) for four minutes or long enough to fully evacuate the engine and bilge compartments of explosive fumes.

**WARNING**

Fire/Explosion Hazard: If equipped with a bilge blower switch, always operate the bilge blower for a minimum of 4 minutes prior to starting the engine. Gasoline vapors can explode, resulting in injury or death.

- Check the bilge for fuel vapors.
- Verify that the blower is operating properly.
- Always run the blower when the boat is operating below cruising speed.
- Attach the engine emergency stop switch lanyard to the boat operator.
- Check that all passengers are seated properly.
- Position the lower drive power trim to the full DOWN position.
- Start the engine.

STEERING

**WARNING**

Control Hazard: If the engine is shut off (no thrust), you will have no steering control, and the boat's momentum will cause it to move forward even though the engine has stopped. Even at low engine speeds where thrust is reduced, a loss of steering control can occur.

Steering a boat is very different from steering an automobile. Steering and maneuvering a boat is far more difficult and requires time and practice to master.

When steering a boat, it is important to understand the causes and effects of turning. Since both thrust and steering are at the stern of the boat, the stern will push away from the direction the steering wheel (helm) or tiller arm is turned. The boat seems to skid across the water while turning, which feels very different from an automobile making a turn.

Steering in reverse has its own challenges. Practice forward and reverse steering to gain comfort and to feel in control of the boat in any steering situation.

Be prepared for wind and current while steering the boat. Steering in wind or water currents is difficult and requires skill to be able to anticipate and compensate for these effects.

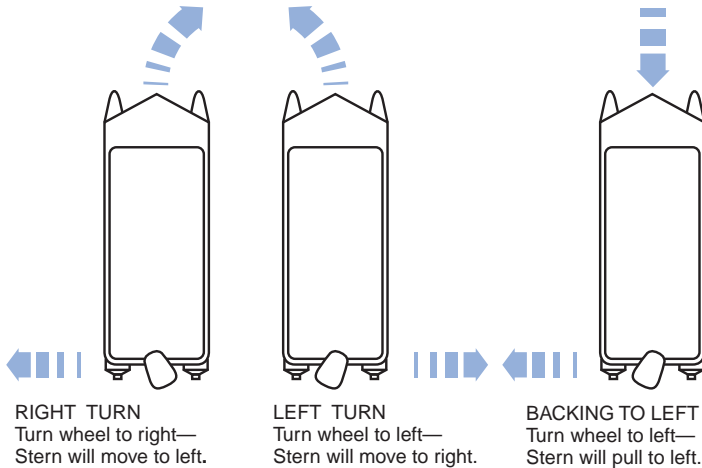

KC-0117-A

Rotational thrust of the propeller is an aspect most single propeller-driven boats share and needs to be compensated for at slow speeds. During rotational thrust, torque is transmitted to the helm and may cause the boat to drift either port or starboard when moving forward at a slow speed. Rotational thrust usually goes unnoticed at high speeds. While moving forward at a slow speed, constant helm corrections are usually necessary to maintain a straight course.

Twin-engine and dual-prop boats usually compensate for rotational thrust of the propellers by using one counterrotating drive with a counterrotating propeller, and one standard clockwise-rotating drive and propeller to reduce the effects of steering torque at all boat speeds.

STOPPING

Reverse thrust is commonly used to slow and stop a boat. The amount of reverse thrust needed to stop will vary due to boat design, load and speed.

⚠ WARNING *Control Hazard: Always reduce engine speed to idle and pause in NEUTRAL before shifting from FORWARD to REVERSE or REVERSE to FORWARD. Abrupt stopping and steering loss can occur if the propulsion unit is shifted quickly from FORWARD to REVERSE or REVERSE to FORWARD. Never shift into REVERSE at planing or high forward speeds.*



A boat does not have brakes. Controlling the boat to a stop and while stopped are important skills that must be learned. Reverse thrust is commonly used to slow and stop a boat. The continued momentum of a boat will vary according to the boat design, load and speed. You must also consider and learn to compensate for the effects of wind and current. Stopping in wind or water currents is difficult and requires skill to be able to anticipate and compensate for these effects.

- To stop or slow forward motion, always gradually return the throttle(s) to the slow IDLE position, pause and shift into NEUTRAL, then pause and shift into REVERSE.

**WARNING**

Control Hazard: Gradually return the throttle(s) to the slow IDLE position. Failure to do so can cause loss of boat control and engine propulsion system damage.

- If the boat has been driven for a long period of time at high speed, allow the engine a two- to three-minute cool-down period at low idle in NEUTRAL.
- Turn the ignition key to the OFF position.

NOTICE

Never pull the lanyard from the engine emergency stop switch for normal shutdown. Doing so may impair your ability to restart the engine quickly.

- Avoid collisions; at high speeds the boat will require more time and distance to stop or slow.
- The proper use of trim tabs and outdrive trim angle is important when slowing to a stop. Qualified local boating authorities can provide proper instruction in slowing and stopping your boat.

SHIFTING

The following information is a basic guideline only and may not apply to the specific shift control. See the *Engine Operator's Manual* or control manufacturer's information for the shift control operation, adjustment and maintenance.

- Most side-mounted throttle and shift controls have a neutral detent lock that must be released before shifting from NEUTRAL.
- Always use a brisk and decisive movement when shifting into or out of gear.



- Always pause in NEUTRAL before shifting from FORWARD to REVERSE, or REVERSE to FORWARD. Most throttle and shift controls have a detent position for NEUTRAL, FORWARD and REVERSE engagement positions. These detent positions are important; when shifting into and out of gear, always pause in these positions.
- Never shift into REVERSE while your boat is in FORWARD gear when traveling at any speed above idle.
- Always keep the shift control clean and clear of obstructions.

ACCELERATING AND RUNNING UNDERWAY

You must understand the boat's equipment and controls in order to drive and control the boat in a forward direction at all speeds and in all conditions. Learning to drive and control the boat can be challenging; take this matter seriously and spend plenty of time practicing.

The phrase "on plane" is commonly used when referring to the running angle of a boat in forward motion. When a boat is "on plane," its hull is usually running level or almost level with the water's surface, which is considered level. The level "plane" of the water's surface is the most efficient angle to run in. This basically means that the boat is running on top of the water and not plowing through it.

Some pontoon boats with low horsepower engines and/or heavy loads may not be able to reach "plane."

Factors to consider when accelerating a boat forward and running at the most efficient planing angle are:

- Boat design
- Hull type and condition
- Boat load and distribution of weight
- Engine capability and condition
- Propeller type, size and condition
- Outdrive and boat power trim equipment and condition

Because all boats are different and vary in design, purpose and load, planing angles and characteristics will vary among all boats. Become familiar with the boat's characteristics and obtain qualified assistance.



The following guidelines provide a basic understanding of forward acceleration and operating on plane while underway:

- Always look in front of and around you before proceeding. Avoid collisions before accelerating; be aware and stay clear of people and obstacles in the water.
- Always advise all passengers on board of your intention to accelerate and get underway.
- Stow and fasten all loose gear.
- Make sure the engine emergency stop switch lanyard is connected to the operator.
- If equipped, adjust the boat trim tabs up or to a neutral position with the hull.
- If equipped, adjust the engine power trim to the full-in position.
- Shift from NEUTRAL into FORWARD detent idle position.
- Adjust steering to the direction of travel.
- Using a controlled and constant motion, move the throttle control forward.

**WARNING**

Control Hazard: When accelerating forward, the bow can rise and restrict visibility. Never remove your hand from the steering wheel. The rotational thrust of the propeller under rapid acceleration can create high steering torque and rapidly change the direction of steering, causing loss of control.

- As the boat begins to move, the bow will rise and the boat will tend to plow through the water. As acceleration increases, the boat will begin to plane or level out within a few seconds. If it will not plane to a near-level position and has sufficient horsepower, slowly reduce the throttle back to the FORWARD detent idle position. Recheck the load distribution and trim equipment position to determine the cause.
- Once the boat is on plane, the steering torque will diminish; however, never remove your hands from the helm while underway. While running at a planed position, you will notice greater throttle response and steering control as you continue to accelerate or achieve the most comfortable and safe speed for the conditions. You can achieve better performance, control and running efficiency using the engine's power trim and the boat's trim tabs, if equipped.
- Be aware of the wake you create and anticipate the effect it will have on others. During acceleration, deceleration and at speeds other than on plane, a heavy wake is usually created. You are responsible for the boat's wake and any damage or injury it causes.



- Obey no-wake areas and speed-controlled areas.
- Stay clear of or at a safe distance from other boats.
- Avoid collisions; at high speeds the boat will require more time and distance to stop or slow.

CHECKS DURING AND AFTER OPERATION

- Check gauges frequently for signs of abnormal conditions.
- Check that controls operate smoothly.
- Check for excessive vibration.

POWER TRIM AND TILT

The following information is a basic guideline only and may not apply to your specific power tilt unit. See the *Engine Operator's Manual* for information on your power tilt operation, adjustment and maintenance.

The engine's power tilt generally operates in conjunction with the power trim system, which is commonly called power trim and tilt. This system allows you to raise and lower the lower drive unit and propeller to adjust trim (the planing and running angle of the boat while underway) and tilt (used to position the lower drive unit up beyond the power trim range used for trailering, launching or beaching). Never use power tilt while the engine is running.

POWER TRIM

The following information is a basic guideline only and may not apply to your specific power trim unit. See the *Engine Operator's Manual* for information on your power trim operation, adjustment and maintenance.

The engine's power trim allows you to raise and lower the lower drive unit and propeller to adjust the planing and running angle of the boat while underway.

Boat trim adjustment while underway greatly affects boat performance and efficiency. During normal operation while underway at speed, trim the boat to the best possible position to reduce the wetted surface of the hull. With less boat in the water, both speed and fuel economy increase. Adjust systems with manual trim adjustment for best overall operation for the load and conditions. Engines with power trim allow for continuous adjustment for best results.

Adjust the power trim by using a switch at the helm area or on the throttle control. Trim gauges are available in most applications to provide a visual gauge-to-trim position. Most gauges indicate trim position between UP (out, away from the transom) and DOWN (in, closer to the transom).

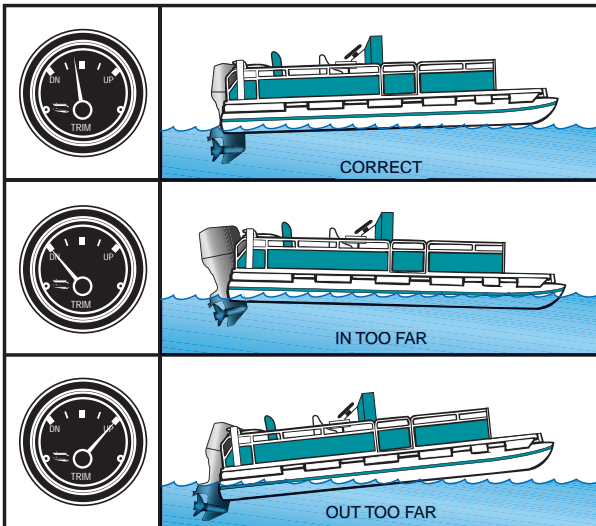

KC-0123C-A

General effects of power trim underway:

Trim in too far (closer to the transom) can be dangerous:

- At high speed or high throttle, the boat may “bow steer.” Bow steering can be violent and dangerous.
- Speed decreases.
- Fuel economy decreases.
- Boat will have difficulty achieving a proper running, planing position.

Trim out too far (away from the transom):

- Steering torque increases.
- Speed decreases.
- Fuel economy decreases.
- Boat may handle and steer poorly.
- Boat may bounce or porpoise.
- Engine RPM increases.
- Propeller may ventilate as it nears the surface of the water and slip excessively as it pulls air from the surface. This will cause engine RPM to rapidly rise.
- Boat will have difficulty getting on plane from an idle position.

**WARNING**

Control Hazard: Do not trim the engine out too far or you may lose control of the boat. If you lose control of the boat, pull back on the throttle and trim in at the same time.

See the *Operating the Boat* section of this manual for more details.

General power trim operation guidelines:

- When getting on plane from an idle position, start with the trim full in. As the throttle position increases, the boat speed will increase and drive the bow up. As acceleration proceeds, the bow will start to come down. When the bow starts to fall and the boat begins to plane, slowly start to trim out.
- Trimming out while underway generally causes the boat to rise up and plane. The boat begins accelerating without adjusting the throttle as less of the boat is dragging in the water. Trimming up causes the engine RPM to increase. It is very important to watch the engine tachometer to keep it at or near full throttle operating range and not to exceed the engine's wide-open throttle operation range. See the *Engine Operator's Manual* for the engine's wide-open throttle operation range.

**WARNING**

Control Hazard: At speed, do not trim in too far. "Bow steering" (a condition where the bow bites hard into a turn and the stern of the boat violently spins out) may occur when at high speed or under hard throttle. For optimum trim position, trim out till the prop starts to slip or porpoising occurs. Then trim back in till those symptoms go away. Mild excessive trim out is a good way to gauge where proper trim is for your pontoon.

High-speed operation on smooth water provides stability, but you must maintain control by using quick reactions and adjustments. Know your limits and stay within them. Keep one hand on the steering wheel and the other on the throttle controls at all times.

**WARNING**

Control Hazard: If you lose control of the boat, pull back on the throttle and trim in at the same time.

Constant adjustments are necessary for rapidly changing conditions. Small inputs of throttle and steering are exaggerated at high speeds. Depending on the speed, keep watch well ahead so that you have enough time to react.

NOTE — Bennington BowRider and Twin-Engine boats often run at half-to-full trim out. Full trim in may not be needed on these models.



PERFORMANCE OPERATION

Pontoon boats with triple pontoons and deck boats often have high horsepower engines, or twin engines for increased performance. Operators of these boats must exercise additional caution when turning or operating in rough water at high speeds. Practice operation by yourself in open water by gradually increasing speed so you get a feel for the operating characteristics of the boat. Do not take passengers until you are confident of your operating abilities. Inform passengers of your intentions, require they wear a life jacket, sit in designated seats and use any available handholds. Do not make sharp turns or operate too fast for conditions.

DOCKING

Practice leaving and approaching the dock to become familiar with the procedures.

Helpful guidelines when departing from the dock:

- Make sure you have sufficient space to maneuver the boat away from the dock, other boats and any other obstacles that may hinder your departure.
- Always allow sufficient clearance to the stern for the engine to clear any obstructions.
- Be aware of other boat traffic, wind and water conditions before departing.
- Make sure the engine is started and you have boat movement under control before casting off any mooring lines.
- Always proceed slowly when departing from a dock.

Helpful guidelines when docking:

- Make sure you have sufficient space to maneuver your boat around the dock, other boats and any other obstacles that may hinder your approach.
- Be aware of other boat traffic, wind and water conditions on your approach.
- Approach from a direction against the wind or current.
- When possible, approach slowly from a 45-degree angle and then steer parallel to the dock.
- Have fenders, dock lines and assistance ready.



WARNING *Personal Injury Hazard: Never use your hand, arm or any other part of your body to attempt to keep the boat from hitting the dock. The boat could push against the dock, causing severe injury.*

- If possible, throw a mooring line to a person on the dock and have that person secure the bow. With the bow secure, swing the stern in with the engine or pull it in using a boat hook or the stern line.
- Tie off the bow and then the stern.
- Use bow and stern dock lines, as well as spring lines, for additional security.
- Use fenders to protect the boat from damage.
- Never attach a dock line to a point or part of the boat that is not designed to withstand the stress and the weight of the boat.
- If planning on docking the boat for a long period of time, use chafing protectors on the lines to protect the boat's finish.
- Leave some slack in the lines to allow for wave movement or tidal action if applicable.

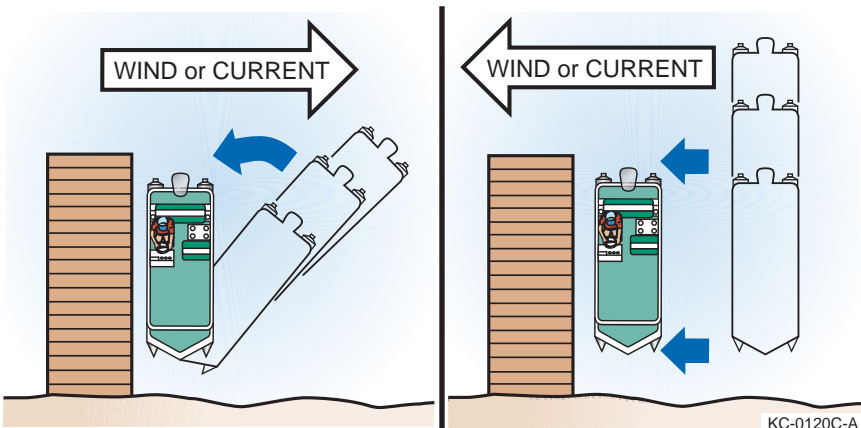



MOORING

Because mooring configurations vary, consult with other experienced boaters or the boat dealer for recommendations on properly mooring the boat. Always moor the boat securely to prevent personal injury or property damage.

Helpful guidelines when mooring:

- Each mooring line must be of the appropriate strength, material and type to safely secure your boat when moored.
- Each mooring line must be longer than the length of the boat.
- Use bow and stern mooring lines, as well as spring lines, for additional security.
- Use fenders to protect the boat from damage.
- When possible, tie up with the bow facing into the wind or current.
- Never attach a mooring line to a point or part of your boat that is not designed to withstand the stress and the weight of the boat.
- Only use the bow eye, stern eyes and other cleats or attachment points that have been approved for mooring. Designated strong points should be used whenever possible.
- If you plan on mooring the boat for a long period of time, use chafing protectors on lines to protect the boat's finish.
- To avoid mold and mildew keep floor storage lid and seat storage areas open.
- Leave some slack in the lines to allow for wave movement or tidal action if applicable.

ANCHORS AND ANCHORING

Anchors are available for various applications and come in many sizes, types and shapes. Boat weight and size are primary factors in choosing an anchor. When selecting an anchor, consult other qualified boaters familiar with waters or the boat dealer.

Anchor line is constructed from various materials and is available in many diameters and types. The anchor rode for recreational boats consists of the anchor line connected to a length of chain attached to the anchor. Consult with the boat dealer for a recommendation on appropriate lines for the boat anchor and application.

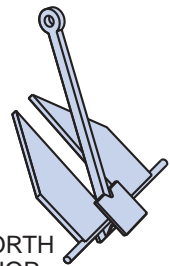

DANFORTH
ANCHOR

KC-0042-A



OPERATING THE BOAT

For most applications, anchor line length should be at least six to seven times longer than the depth of the water in which you are anchoring. Always have plenty of additional anchor line on board. If anchoring in tidal waters, consider a rode chain about the length of the boat and increase the total anchor line length to ten times the depth of the water at low tide.

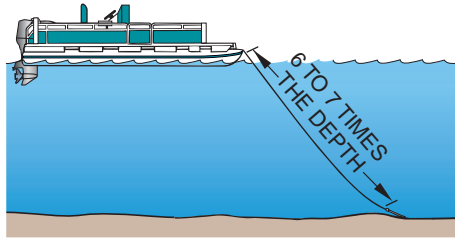

KC-0147C-A



WARNING

Sinking Hazard: ALWAYS anchor from the bow; NEVER anchor from the stern. A small amount of current will make a boat unsteady. A strong current can pull a boat anchored by the stern under the water and keep it there.



WARNING

Collision Hazard: ALWAYS anchor in areas where the boat will not disrupt other boats. Do not anchor in a channel or tie up to any navigation aid. It is dangerous and illegal.

Helpful guidelines when anchoring:

- Make sure the anchor line is tied to the anchor. Tie the other end of the line to the forward cleat or bow eye.
- Head the boat into the wind or current over the spot where you want to lower the anchor.
- Stop the boat before lowering the anchor.
- Slowly lower the anchor until it hits bottom.
- Allow the boat to back away, keeping tension on the line.
- Release at least six to seven times as much line as the depth of the water.
- Secure the anchor line to a designated strong point, typically the bow eye or dedicated anchor bit.
- Firmly pull on the line to make sure the anchor is holding.
- Occasionally check your position against the shoreline. If the anchor is dragging and the boat is drifting, reset the anchor.

Helpful guidelines when weighing (pulling in) the anchor:

- Start the engine(s).
- If necessary, move forward until enough tension is off the anchor line to allow for retrieval of the anchor. Avoid running over the anchor line; retrieve the line as you approach the anchor.



- Once the anchor line is straight up and down, lift the anchor from the bottom.
- If the anchor is stuck, attach the anchor line to the bow cleat so it is tight. The up-and-down motion of the bow from wave action may loosen the anchor from the bottom. If the anchor remains stuck, let out a few more feet of line and attach it to the bow cleat. While keeping tension on the line, slowly maneuver your boat around the anchor to help loosen it. Avoid running over the anchor line.
- Always stow and secure the anchor and line before departing.

LINES AND KNOTS

Mooring, anchor and other nautical lines are constructed from many different types of materials, and are available in many diameters and styles. Consult with your local marine supply store for a recommendation of appropriate lines for the boat and application. Commonly used mooring lines are constructed of a high-quality synthetic material in a double-braided configuration and usually have eye splices on at least one end.

Learn and become familiar with tying and using knots. Knowing how to use knots and lines properly can prevent personal injury and property damage.

Practice tying lines to docks, cleats and anchors, and connecting two lines together. Consult other qualified boaters or the boat dealer, or visit the local bookstore, library or the Internet for information on the proper use of nautical lines and knots. The following illustrations represent a few examples of securing mooring lines.

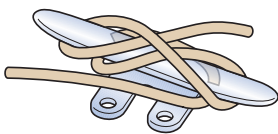

Cleating an open line

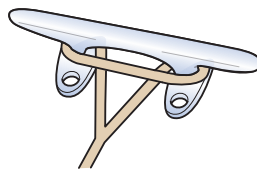

Cleating an eye-spliced line

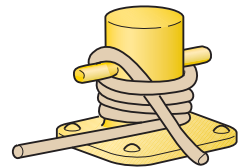

Securing to a dock bit

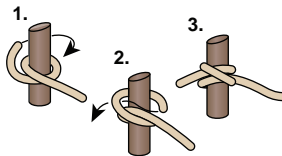

Securing load line
(clove hitch)

A "double half hitch" should always accompany a "clove hitch" on the load line.

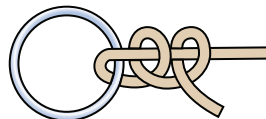

Securing load line
(double half hitch)

KCB-0010



SECTION

7

OPERATING THE BOAT

This Page Intentionally Left Blank

Section 8

TRAILERING AND LAUNCHING

Before using the trailer, review *Safety in Section 2*.

LEGAL CONSIDERATIONS

The following information is intended as a basic guideline only. See the *Trailer Operator's Manual* for information on operation, adjustments and maintenance.

Before using the trailer, contact your state's Department of Motor Vehicles (and that of other states through which you may be traveling) for information on trailering regulations. Trailer regulations vary widely from state to state, and it is your responsibility to be in compliance with all regulations when trailering the boat.

Regulations include, but are not limited to, trailer registration, licensing, width, height, length, lights, safety chains, tie-downs, hitch type, weight capacity, brakes, spare wheels, vehicle mirrors and gross vehicle weight.

TRAILER CLASSIFICATION

Trailers are separated into four classes based on the Gross Vehicle Weight Rating (GVWR):

TRAILER CLASS	GVWR
Class One	under 2000 lb (907 kg)
Class Two	over 2000 lb (907 kg) and under 3500 lb (1588 kg)
Class Three	over 3500 lb (1588 kg) and under 5000 lb (2268 kg)
Class Four	over 5000 lb (2268 kg)

TRAILER TYPE

Trailers are designed for many applications and can vary in style. To prevent damage to the boat and/or personal injury, always use the appropriate trailer for proper support of the boat. To avoid corrosion in saltwater applications, do not use carpeted bunks on lifts and/or trailers. Carpeted bunks become saturated with saltwater and will corrode raw aluminum pontoon tubes. Contact the dealer for more information.

TRAILER GROSS VEHICLE WEIGHT RATING

All trailers must display a Gross Vehicle Weight Rating (GVWR) decal, which shows the load-carrying capacity plus the weight of the trailer. The total weight of the boat (fully loaded with fuel, batteries, water, etc.), engine, gear and trailer must never exceed the GVWR.

TOWING VEHICLE

The towing vehicle must be able to safely pull the full trailer and boat load. Never pull a trailer load that exceeds the vehicle's towing capacity; you risk losing control of the trailer and/or vehicle. Before trailering, always check the *Vehicle Operator's Manual* for maximum towing/trailering load specifications and maximum gross vehicle weight specifications that include the fully loaded trailer.

VEHICLE TOWING HITCH

The towing vehicle must be able to safely pull the full trailer and boat load. The vehicle must have a towing hitch that is capable of safely handling the trailering load and tongue weight of the trailer.

Hitches are designed for many applications and can vary in style. Use professional assistance when selecting the correct hitch and hitch ball for the towing application.

 **WARNING** *Control Hazard: A vehicle hitch that is underrated or improperly installed can lead to loss of control of the trailer and/or vehicle. Never use a hitch that is not rated to pull the maximum weight of the trailering load or that is not rated for the maximum tongue weight that the trailering load applies.*

Hitches are divided into classes that specify the trailer's gross trailer weight and maximum tongue weight for each class.



MAXIMUM TONGUE WEIGHT

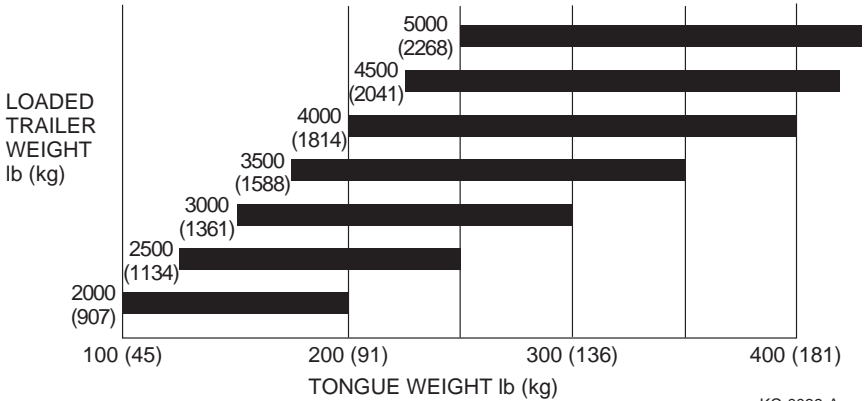

KC-0039-A

HITCH BALL AND TRAILER COUPLER

Most boat trailers have a coupler that connects to a hitch ball attached to the towing vehicle's hitch. The trailer hitch coupler must always match the size of the hitch ball. The correct hitch ball diameter for the coupler is usually marked on the trailer coupler.

⚠ WARNING **Control Hazard:** *Never use a hitch ball size or rating that does not match the trailer coupler specifications. Using an improper size or rated hitch ball can lead to loss of control of the trailer and/or vehicle.*

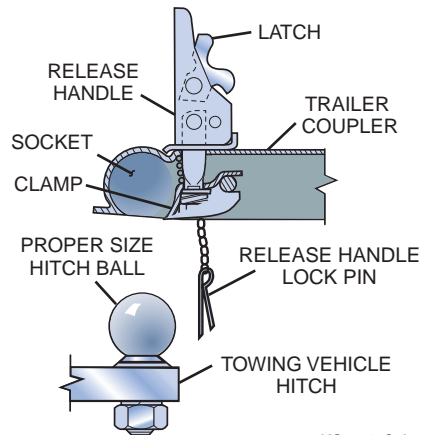

KC-0043C-A



Trailer hitch balls are sized and rated for use based on the trailer GVWR:

TRAILER CLASS	GVWR	HITCH BALL DIAMETER SIZE
Class One	under 2000 lb (907 kg)	1-7/8 in. diameter size
Class Two	over 2000 lb (907 kg) and under 3500 lb (1588 kg)	2 in. diameter size
Class Three	over 3500 lb (1588 kg) and under 5000 lb (2268 kg)	2 in. diameter size
Class Four	over 5000 lb (2268 kg)	2-5/16 in. diameter size

SAFETY CHAINS

The boat trailer's safety chains prevent the trailer from completely detaching from the towing vehicle when underway. Connect the chains to the vehicle's hitch or frame and crisscross the chains under the trailer tongue to prevent the tongue from dropping to the road if the trailer separates from the hitch ball. Rig the chains as tight as possible with enough slack to permit full-free turning. Safety chains must be rated at the same or greater weight capacity as the trailer's GVWR.

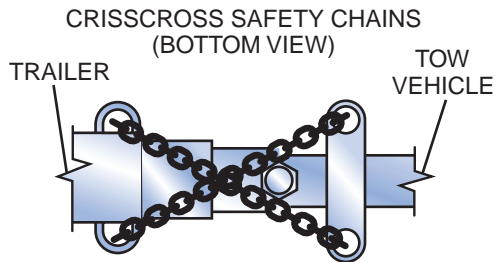

KC-0045C-A

Never allow the chains to drag on the ground when trailering.

Attach the chains properly and securely between the towing vehicle and trailer before trailering.



TRAILER BRAKES

In some states, any trailer with a GVWR of 1500 lb (680 kg) or more is required to have trailer brakes.

Check with your state and local authorities for more information.

The three basic types of trailer brakes are electric, hydraulic surge and air-actuated. If the trailer is equipped with brakes, see the *Trailer Operator's Manual* for more information on operation, adjustments and maintenance.

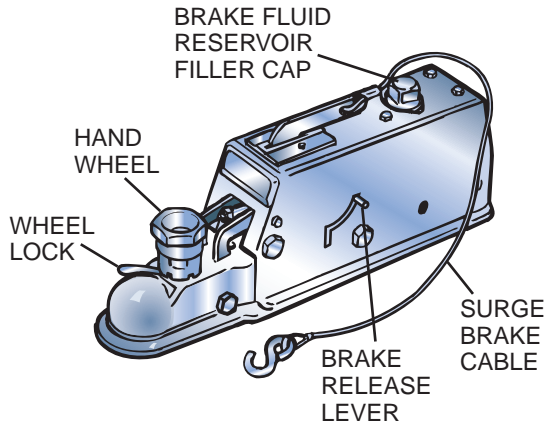

KC-0044C-B

5-PIN WIRING CONNECTOR

Some trailers equipped with surge brakes may utilize a 5-pin wiring connector. These trailers use an electric solenoid valve that allows brake fluid to bypass back to the reservoir while in REVERSE. The solenoid is usually connected to the reverse lights on the tow vehicle to ensure the brakes only bypass in REVERSE. The fifth pin is for deactivating the brakes when backing up, and is required to be connected to the vehicle's power when backing up.



TRAILERING GUIDELINES

Follow these guidelines when trailering:

- Before driving, make sure the vehicle maintenance and trailer maintenance are current. This is very important because towing puts additional stress on the tow vehicle.
- Make sure the wheel lug nuts/bolts on the tow vehicle and trailer are tightened to the correct torque.
- Be sure the hitch, coupler, draw bar and other equipment that connect the trailer and the tow vehicle are properly secured and adjusted.
- Make sure all running lights, brake lights, turn signals and hazard lights are working.
- Verify that the brakes on the tow vehicle and trailer are operating correctly.
- Maintain a safe speed as regulated by the trailering laws of the state where you are traveling.
- Check the trailer and vehicle brakes for proper operation and fluid level prior to departure.
- Check the trailer for damage prior to departure.
- Make sure the hitch ball and trailer coupler are the same size and bolts and nuts are tightly secured.
- The coupler must be completely over the ball, and the latching mechanism must be locked down.
- Make sure the safety chains are properly crisscrossed and connected. They should not touch the road but should have enough slack to make turns. If the ball were to break, the trailer would follow in a straight line and prevent the coupler from dragging on the road. Make sure the trailer emergency brake cable or chain is also installed to the tow vehicle frame.
- Ensure the breakaway system lanyard is connected to the tow vehicle and not to the safety chains or ball mount.

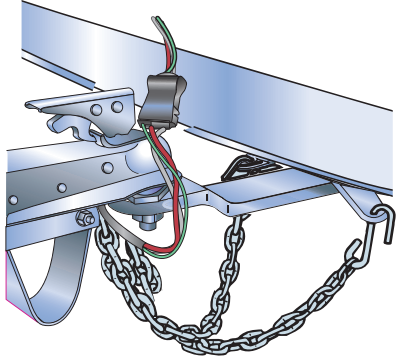

KC-0046C-A

NOTE — Make sure the towing vehicle and trailer are in compliance with all state and local laws. Contact your state motor vehicle bureau for laws governing the towing of trailers.

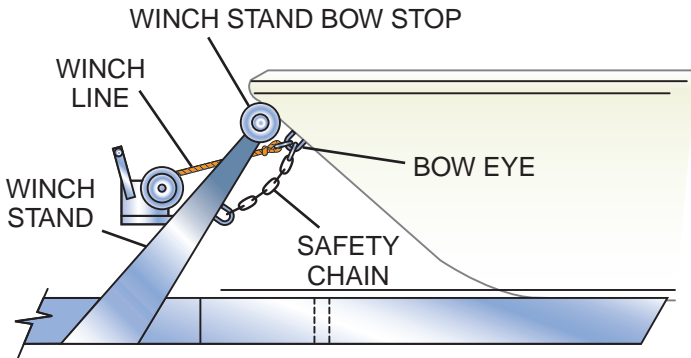

KC-0047C-A

- Once the trailer is secured to the vehicle hitch, stow the trailer jack or lift so that it will not hit the ground.
- Check and correct tire pressure on the tow vehicle and trailer, including the spare tire. Under-inflated tires heat up rapidly and may cause tire damage or failure. The proper tire pressure is listed on the trailer certification plate.
- Check trailer wheel bearings before each trip.
- Secure the stern of the boat to the trailer from the stern eyes.
- Fasten the bow of the boat to the trailer with the bow winch line connected to the bow eye and bow safety chains.
- If travel conditions require, use an additional tie-down strap across the rear of your boat from side to side to further secure the stern.
- Check all strapping material for wear.
- Check that the wiring is properly connected. It should not touch the road but should be loose enough to make turns without disconnecting or damaging the wires.
- Too much or too little tongue weight makes steering difficult and causes the tow vehicle to sway. Put approximately 5% to 10% of boat and trailer weight on the tongue.
- Drive with the vehicle and trailer running lights on.
- Check load distribution to make sure the tow vehicle and trailer are properly balanced front to back and side to side.
- Check that all items are securely fastened on and in the trailer.
- Be sure the trailer jack, tongue support and any attached stabilizers are raised and locked in place.



TRAILERING AND LAUNCHING

- Check side-view mirrors and rearview mirrors for good visibility.
- Check routes and restrictions on bridges and tunnels.
- Keep wheel chocks and jack stands on hand.
- Side curtains, backdrop, aft curtains, convertible tops and detachable windshields are not designed to stay on boats at highway speeds. Before towing, take down the convertible top, side curtains, back cover and detachable windshield, if equipped.
- Close and lower bimini convertible top using the trailering struts and secure.
- Remove any covers that are not designed to stay on boats at highway speeds.
- Carry a spare tire and wheel for both the trailer and the towing vehicle, along with tools to change them.
- See the *Engine Operator's Manual* for engine-related trailering information. Continuous road shocks may fatigue the boat's steering system.
- Tie outboard motors in place so they will not tilt or turn from road shock.
- On extended trips, carry spare wheel bearings, seals and races.
- While traveling, check the wheel hubs every time you stop. If the hub feels abnormally hot, inspect the bearing before continuing your trip.
- Carry a fire extinguisher in the vehicle.
- Turn carefully while towing a trailer; additional space and distance are needed.
- Drive slowly over railroad tracks or rough roads.
- While trailering the boat from lake to lake, boaters may unknowingly introduce a foreign aquatic species from one lake to the next. Thoroughly clean the boat below the waterline, remove all weeds and algae and drain the bilge and livewells before launching it in a new body of water.

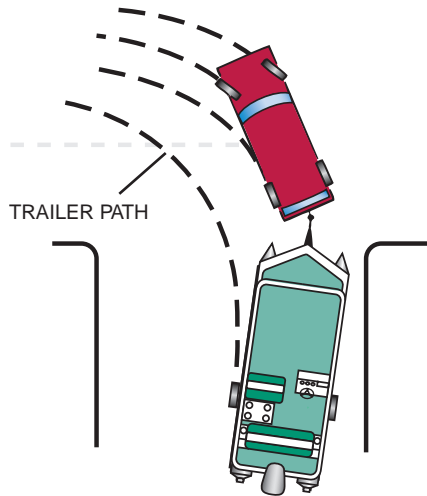

KC-0291C-A



BACKING UP

If you have never towed a trailer before, take time to practice and become comfortable with backing up the boat and trailer. Situations can arise in traffic, or when launching, that will require you to be able to back up the trailer safely.

Follow these guidelines when backing a trailer:

- Back slowly and make small steering adjustments.
- Turn the car wheels in the direction opposite where you want the trailer to go.
- After the trailer begins moving, turn the car to follow it.
- Have a second person assist you with audible and hand signals.

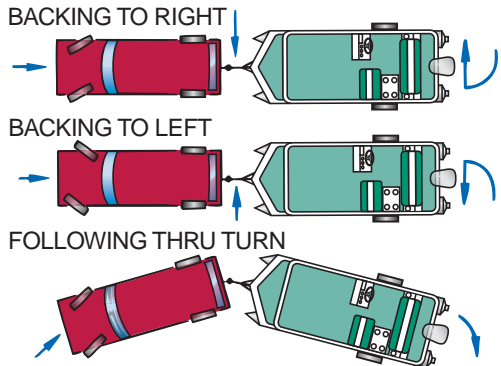

KC-0164C-A

LAUNCHING

Before launching, inspect the launch ramp for any problems that may hinder launching or make launching unsafe. Ramps can be slick and dangerous to drive or walk on, and may have unseen drop-offs beneath the water that would pose a safety hazard. Always be aware of water conditions and the effects of the wind when launching.

Before launching, inspect the boat and trailer for damage. Do not launch if you detect damage or find that the engine or propeller is not in good operating condition. Have any repairs made before launching.

Use courtesy when preparing the boat for launching by preparing away from the ramp on level ground before proceeding to the launch ramp.

When launching the boat on the trailer, have two or more people assist you. Since all launches are different, the following procedures are intended as guidelines only:

- Verify that the vehicle's brakes, including the parking brake, are in proper working order.
- Make sure the trailer is securely fastened to the vehicle.
- Remove the boat cover, if equipped.



TRAILERING AND LAUNCHING

- Check that the bilge drain plug is in place and all other plugs that allow water to leak into the boat are in place.
- Remove all tie-downs from the boat.
- Attach the bow and stern docking lines.
- Attach boat fenders if necessary.
- Disconnect the trailer's light harness from the car.
- If applicable, trim or tilt the engine/outdrive up to avoid damage.
- Make sure the bow winch and strap are securely locked and fastened.
- Make sure the bow winch safety chains, if equipped, are in place.
- Make sure all required documentation and safety equipment are on board.
- Verify that batteries are fully charged and in good condition.
- Check fuel level; add fuel if necessary.
- Always launch with the help of another person.
- Make sure there is no one on the ramp behind the boat.
- Keep the trailer/vehicle combination as straight as possible and at 90 degrees to the shoreline.
- Back slowly down the ramp until the transom of the boat is a few inches in the water; then stop the vehicle.
- Stop the vehicle and shift into PARK (automatic transmission) or REVERSE (manual transmission). Apply the brakes and/or parking brake. If possible, use wheel blocks.
- Position the mooring lines within reach of the dock.
- Disconnect the bow winch strap and safety chains, if equipped, from the bow eye.
- Manually back the boat clear of and off the trailer into the water and secure to the dock using mooring lines.
- Remove any wheel blocks and release the vehicle brakes. Pull the trailer slowly out of the water, and secure and park in a designated area.
- Board the boat.
- Lower the engine/outdrive, if applicable.
- Run the bilge blowers as required, if equipped.
- See the *Engine Operator's Manual* for starting procedures.
- Remove dock lines from the dock and proceed slowly away from the dock.



LOADING GUIDELINES

Follow these guidelines while loading the boat onto the trailer:

- When loading the boat on the trailer, have two or more people assist you.
- Stop, turn off the engine and secure it to the dock with dock lines at a position clear from where the trailer will be in the water.
- If applicable, trim or tilt the engine/outdrive up to avoid damage.
- Verify that the vehicle's brakes, including the parking brake, are in proper working order.
- Disconnect the trailer's light harness from the tow vehicle.
- Make sure the trailer is securely fastened to the vehicle.
- Back the trailer slowly down the ramp until it is positioned so that the boat can be loaded.
- Stop the vehicle and shift into PARK (automatic transmission) or REVERSE (manual transmission). Apply the brakes and/or parking brake. If possible, use wheel blocks.
- Position the mooring lines within reach of the dock.
- Manually position the boat onto the trailer using mooring lines. Make sure it is centered on the supports of the trailer.
- Position the bow eye into the bow stop and connect and secure the bow winch strap and safety chains, if equipped, to the bow eye.
- Secure the mooring lines inside the boat.
- Remove any wheel blocks and release the vehicle brakes. Slowly pull the trailer and boat up the ramp.
- Secure the transom to the trailer.
- Prepare for trailering as necessary.

REPORTING SAFETY DEFECTS

If you believe that your boat trailer has a defect which could cause a crash or could cause injury or death, you should immediately inform the National Highway Traffic Safety Administration (NHTSA) in addition to notifying the trailer manufacturer.

If NHTSA receives similar complaints, it may open an investigation, and if it finds that a safety defect exists in a group of trailers, it may order a recall and remedy campaign. However, NHTSA cannot become involved in individual problems between you, your dealer or the boat manufacturer.

To contact NHTSA, you may call the Vehicle Safety Hotline toll-free at 1-888-327-4236 (TTY: 1-800-424-9153); go to <https://nhtsa.safercar.gov>; or write to Administrator, NHTSA, 1200 New Jersey Avenue SE, Washington, DC 20590. You can also obtain other information about motor vehicle safety from <https://www.safercar.gov>

Section 9

BOAT FEATURES AND OPTIONS

Before operating any systems within this section, review *Safety in Section 2*.

The boat may be equipped with a variety of systems to operate the boat and to provide other conveniences you may need while on the water. The following basic and typical information may not apply to your specific application. All of the boat's systems may not be covered in this section. See the *Equipment Manufacturer's Operator's Manual* for specific details.

Regularly inspect and maintain all components and systems to prevent unexpected hazards due to worn or faulty components. Be sure to replace components and hardware with marine-grade parts.

 **WARNING** *Fire/Explosion Hazard: Never use parts not specified for marine use to replace marine-grade parts. Using non-marine specified parts in a marine environment may result in a fire and/or explosion.*

FUEL SYSTEM

The basic fuel systems consist of one or more fuel tanks, tank vents, level sensor and gauge, lines, pumps and valves.

Each tank has an antisiphon valve to prevent fuel from leaking out of the tank should a break occur in the system at a point other than the tank. Some models are also equipped with a fuel shutoff valve at each tank to stop fuel flow from the tank. It is recommended that fuel shutoff valves be closed during long periods of inactivity or storage. Refer to the boat and *Engine Operator's Manual* for specific fuel system information and service information.

ENGINE LUBRICATION SYSTEM

Depending on engine type, the boat may feature one of several engine lubrication systems. Many small-to-mid-range two-cycle outboards are lubricated by oil mixed directly with the gasoline in the fuel tank, while other two-cycle outboards may be equipped with an oil injection system. In each system, the oil is consumed as the engine runs. Oil injection systems include a separate reservoir for oil containment and an oil pump or combination fuel/oil pump that supplies oil to the fuel system for engine lubrication. Four-cycle outboards and sterndrive engines, like automotive, use a sump system where the engine oil is contained in the engine. See the *Engine Operator's Manual* for engine oil recommendations and information.

ENGINE COOLING SYSTEM

Most outboard engines are cooled by using raw water to transfer heat from the engine and then returning the raw water to the sea/lake. A raw water pickup and screen on the lower drive unit allows water into the engine. A pump then circulates the water to cool the engine. Be sure to periodically inspect the intake screen and clear it of any debris which could obstruct water flow into the engine. A continuous discharge of water from the cooling water check port while the engine is running is a visual indication that the engine's cooling system is operating properly.

NOTICE

To prevent engine damage, DO NOT run it with the lower drive unit raw water intake above the waterline or out of the water.

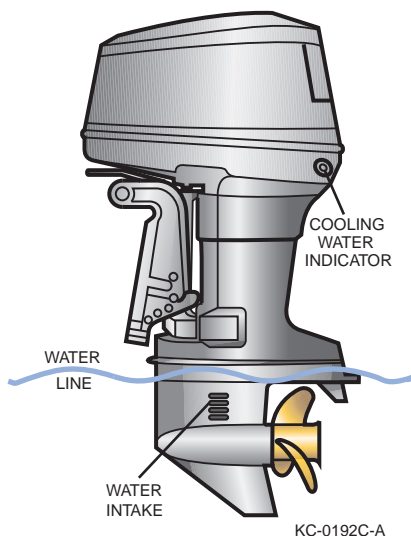

STEERING SYSTEM



WARNING

Control Hazard: *Be sure to inspect the outboard's steering system for damage after striking an underwater object. Stop immediately to inspect for damage that may result in loss of steering control.*



WARNING

Control Hazard: *Improper maintenance of steering system is hazardous and can cause death or serious injury from sudden loss of control. Ensure all steering hardware, cables and grease fittings are regularly inspected and maintained. If any steering problems are noticed, do not operate the boat and contact your dealer immediately for service assistance.*

Steering systems vary in type and operation. The most common steering systems are mechanical, power-assisted and hydraulically operated.

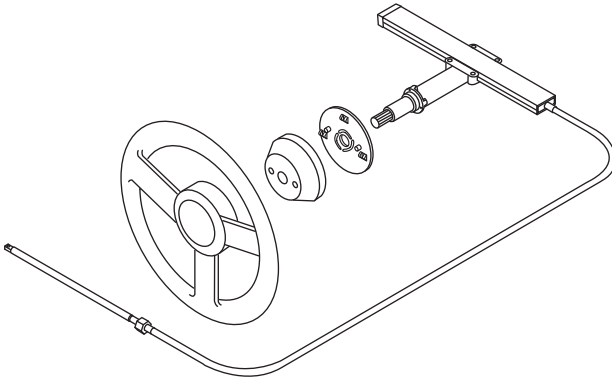

KC-0268-A

Boat steering controls are not self-centering. Always keep a secure grip on the steering wheel to maintain full boat control.

Mechanical steering helm controls transfer the rotary motion of the steering wheel to linear cable motion, which pushes or pulls the engine's steering arm. Some boats are equipped with two mechanical cables to provide positive steering control and additional safety in case one cable fails.

Power-assisted mechanical systems use hydraulic force to assist the manual rotary motion of the helm's movement, providing easier steering for the operator.

Hydraulic systems use hydraulic pressure from a pump connected to the helm to move hydraulic fluid through hoses, and then to move hydraulic cylinders connected to the engine's steering arm. A reservoir, either separate or integral to the pump, holds extra fluid and maintains a pressure head to prevent air from entering the system.

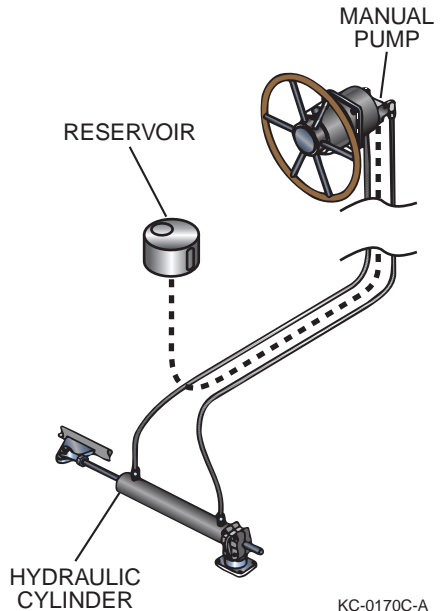

KC-0170C-A



SHIFT AND THROTTLE CONTROLS

Knowing how to operate the shift and throttle controls of the boat is essential for safe and proper operation.

The following basic and typical information may not apply to your specific shift control. See the *Engine Operator's Manual* or control manufacturer's instructions for information on your throttle and shift control operation, adjustment and maintenance.

SINGLE-LEVER CONTROLS - SINGLE OR TWIN ENGINE

Single-lever controls operate both the gear shift and the throttle for one engine with one control lever. Single-lever controls can be used on single- or twin-engine boats.

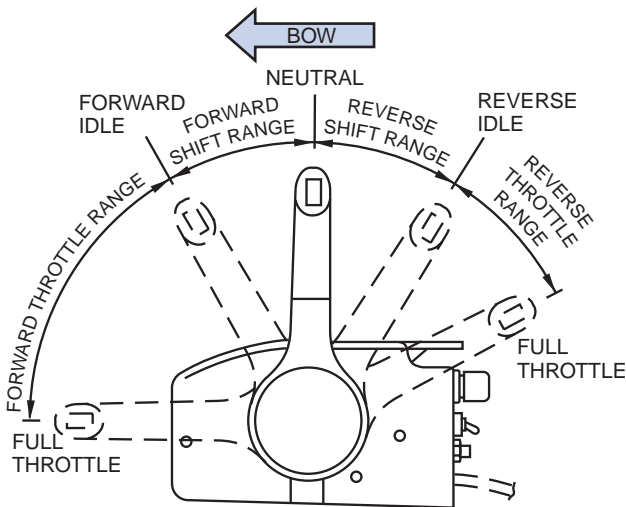

KC-0092-A

NEUTRAL - The lever is detented in the **NEUTRAL** position (center of travel) for starting; the neutral safety switch allows starting in this position only. For engine warm-up, a separate lever or button on the control is used to disengage the shift cable and allow the throttle to advance only while the transmission remains in **NEUTRAL**.



FORWARD - Release the detent lock to allow shifting to the FORWARD position. Moving the lever into the first 15 degrees of travel (toward the bow or up) positions the control in the FORWARD detent IDLE position. Advancing the lever beyond 15 degrees allows throttle increase in FORWARD.

REVERSE - Release the detent lock to allow shifting to the REVERSE position. Moving the lever into the first 15 degrees of travel (toward the stern or down) positions the control in the REVERSE detent idle position. Advancing the lever beyond 15 degrees allows throttle increase in REVERSE.

CONTROL OPERATION GUIDELINES



WARNING *Control Hazard: Improperly maintained controls are hazardous and may cause sudden loss of control. Make sure all shift/throttle hardware and cables are regularly inspected and maintained. Improper maintenance may result in a loss of control.*

- Side mount throttle and shift controls have a neutral detent locking lever that must be released before shifting from NEUTRAL.
- Always use a brisk and decisive movement when shifting into or out of gear.
- Always pause in NEUTRAL before shifting from FORWARD to REVERSE, or REVERSE to FORWARD. Most throttle and shift controls have a detent position for NEUTRAL, FORWARD and REVERSE engagement positions. Engine damage may occur if you rapidly shift into gear without pausing in these detent positions or allowing the engine RPM to lower into the approved shifting range.
- When traveling at high speed, never shift into REVERSE while your boat is in FORWARD gear.
- Always keep the shift control clean and clear of obstructions.

NOTICE

All shift and throttle controls are equipped with a safety switch for start-in-gear prevention. Place the control in the NEUTRAL position before you attempt to start the engine.

- Never attempt to shift when the engine is not running.



ELECTRICAL SYSTEM

Boats may be equipped with one or two types of electrical systems: Direct Current (DC) and Alternating Current (AC).

Most boats use a battery-powered direct current (DC) system; some boats also use a generator or shore-powered alternating current (AC) system. Most systems have a main load panel which serves as the main distribution panel.

DC SYSTEM

 **WARNING** *Fire/Explosion Hazard: Always use caution when operating and maintaining the DC electrical system. Fire or explosion may result from improper use of the DC electrical system.*

Most boats use a 12-volt common negative ground DC system. DC systems are usually the primary electric supply for lights, pumps, blowers, engine starting, etc.

Boats require at least one battery per engine. Multiple-battery systems consist of a cranking battery for each engine and additional batteries that supply auxiliary power to DC electrical circuits.

Battery switches control battery power distribution and disconnect the batteries from the boat's electrical system. The engine's charging system charges batteries connected to the charging system when the engines are running.

Battery isolators prevent accessory loads and other batteries from depleting power from charged batteries. Isolators also allow the engine's charging system to isolate the alternator charging output and distribute the charge among all batteries according to individual need.

The main DC control panel may feature a voltmeter, battery test switch, fuses, circuit breakers and a master breaker switch.

 **WARNING** *Fire Hazard: Never reset a breaker that has been automatically tripped or replace a fuse that has blown without first identifying and correcting the cause of the problem. A fire could result.*

 **WARNING** *Fire Hazard: DO NOT exceed the recommended fuse sizes or bypass the fuse safeguard. Always install the proper (type and rating) fuses whenever replacing or changing fuses.*



PROPELLERS

The following basic information may not apply to all engines. See the *Engine Operator's Manual* for information on propellers for the boat. Consult the boat dealer for assistance when replacing or servicing propellers.

The propeller converts the engine's power into the thrust needed to propel the boat. Care and selection of the propeller is very important for proper boat operation. Propeller size is usually identified by two numbers, such as 13 x 19, and a material identification, such as aluminum or stainless steel. In the number sequence, the first number is the diameter of the propeller in inches and the second is the pitch in inches.

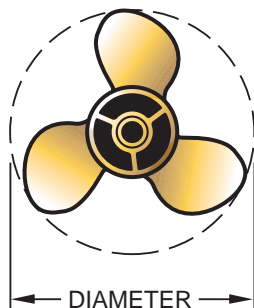

KC-0149C-A

Pitch is the angle of the blades expressed in the theoretical distance a propeller travels in each revolution. In the previous example, the pitch is 19, which means that each revolution of the propeller pushes the boat 19 inches (483 mm) through the water.

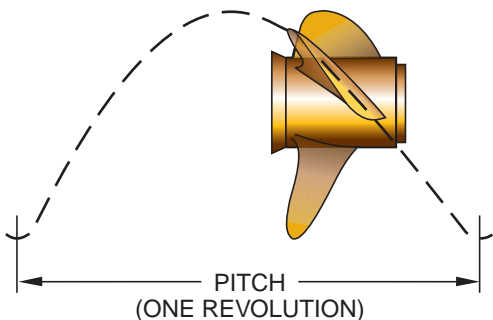

KC-0150C-A

Propellers on boats powered by outboard or sterndrive propulsion systems are usually replaced out of the water to prevent loss of parts and to ensure correct installation. Although propeller replacement can be completed with the boat in the water, it is not recommended. Remove an inboard-powered boat from the water for propeller replacement because the propeller is not accessible while the boat is in the water. Special tools are required for most applications. Always consult the boat dealer for assistance when replacing or servicing propellers.



PROPELLER SELECTION AND REPLACEMENT GUIDELINES

There are many different propeller designs for specific operating characteristics. Always consult a certified marine technician when replacing your propeller.

To prevent accidental start-up, complete the following before installing or removing the propeller:

- Position the shift control in NEUTRAL.
- Position the battery switch to the OFF position and remove the key.
- Place a wood block between the cavitation plate and the propeller to hold the propeller in place. Remove the propeller nut.



WARNING

Personal Injury Hazard: Never use your hand to hold the propeller when removing the propeller nut; the propeller blades are sharp. Wear protective gloves.

DUAL-PROP DRIVES

Many sterndrive and some outboard-powered boats may use a dual-prop drive. Dual-prop drives have one prop turning clockwise and the other prop turning counterclockwise. Dual-prop drives come in rear-facing (sterndrive/outboard) and forward-facing (pod) designs. With either design the forward prop (referenced to the bow of the boat) turns counterclockwise while the rear prop turns clockwise.

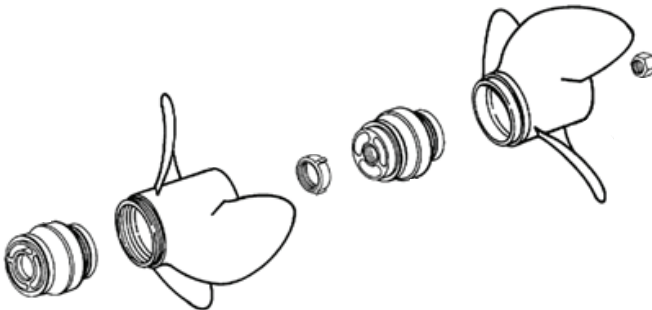

KCB-0012

In dual-prop drives, either prop can have three or four blades and have different pitches and/or diameters. Some configurations can increase top speed at the expense of fuel economy. Always treat the propellers on dual-prop drives as a set and change them out as a set even if only one is damaged. Read the drive manufacturer's owner's information carefully and consult the dealer or a marine propeller specialist for assistance.



GAUGES / INSTRUMENTS

The following basic and typical information may not apply to your specific boat. This section may not cover all gauges on the boat. See the *Engine Operator's Manual* or equipment manufacturer's supplied information on the use and operation of the unique gauges and instruments.

Gauges are visual indicators that help you monitor various system and component operation parameters. Gauges usually have lights integrated into them for visual clarity when operating at night. They are located near the helm area or other main control areas.

MULTI-GAUGES

The boat may be equipped with one or more multi-gauges that combine an analog look with digital display of specific data such as fuel management/economy, trip logs and GPS and is speed-selectable with the touch of a button. Some multi-gauges allow boaters to customize the type of information and how it is displayed. These gauges communicate digitally over an NMEA 2K or CANBUS network and replace mechanical gauges, sensors and wires. Most units support multiple propulsion units and share data with other operation stations. Refer to the *Gauge and Propulsion Manufacturer's Owner's Manual* for more information.

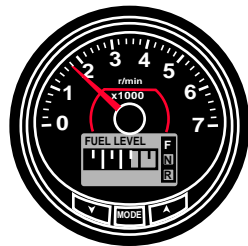

KC-6000

TACHOMETER

The tachometer indicates engine speed in revolutions per minute (rpm). Monitor engine rpm at all times to keep the engine within the proper rpm operating range. See the *Engine Operator's Manual* for the rpm operating range of your engine.

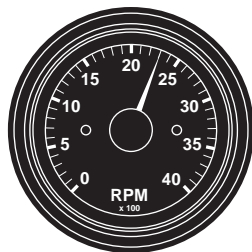

KC-0095-A



SPEEDOMETER

The speedometer indicates approximate forward boat speed in miles per hour (mph).

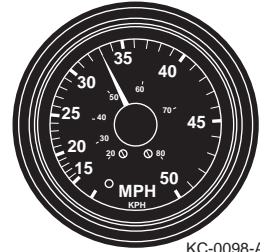

KC-0098-A

FUEL LEVEL GAUGE

The fuel level gauge indicates approximate fuel level in the fuel tank. The accuracy of the fuel gauge may vary as the attitude of the boat changes; the reading is only an approximation. As a general rule, always use the “one third” rule. Use one third of the fuel to reach your destination, one third to return and one third as reserve fuel.



KC-0099-A

ENGINE WATER PRESSURE GAUGE

The engine water pressure gauge indicates the water pressure of the engine cooling system in pounds per square inch (psi). This gauge monitors the engine cooling system operation and indicates overheating problems. See the *Engine Operator's Manual* for the normal operating range.



KC-0100-A



POWER TRIM / TILT GAUGE

The power trim/tilt gauge indicates the angular position of the lower drive unit and propeller in relation to the transom of the boat.

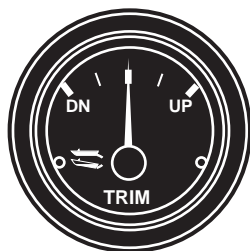

KC-0101-A

VOLTMETER

The voltmeter indicates the voltage of the main cranking battery in volts DC. See the *Engine Operator's Manual* for the normal operating range.

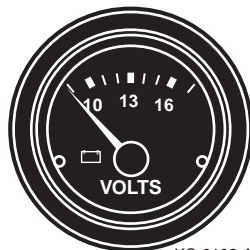

KC-0102-A

ENGINE WATER TEMPERATURE GAUGE

The engine water temperature gauge indicates the water/coolant temperature of the engine cooling system. Most marine engines use seawater to cool the engine. A sudden increase in temperature could be an indication of a blocked cooling passage or a water pump malfunction.

Check the gauge immediately after starting the engine. If the temperature gauge is high, STOP the engine immediately and see the *Engine Operator's Manual* for corrective action.

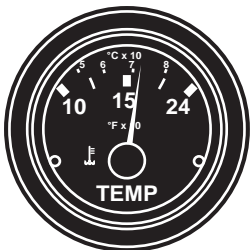

KC-0104-A



ENGINE HOUR METER

The engine hour meter indicates the total number of hours the ignition switch is in the ON position. Under normal conditions, the engine is running when the ignition switch is ON; therefore, the hour meter provides an approximate indication of engine hours. An hour meter is useful in determining scheduled maintenance.

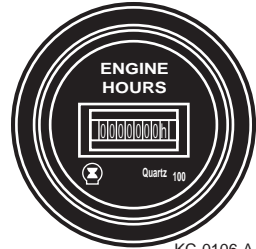

KC-0106-A

OIL LEVEL GAUGE (OUTBOARD ENGINE OIL INJECTION OPTIONAL)

The oil level gauge indicates the level of outboard engine oil in the reservoir used for the oil injection system. Some oil injection systems may provide an indicator on the reservoir. See the *Engine Operator's Manual* for additional information.

WATER DEPTH GAUGE

The water depth gauge indicates the approximate distance between the bottom of the boat and the earth's surface directly below the transducer. To avoid running aground in shallow water, always add extra distance to meter readings. See the manufacturer's instructions for installation requirements and operating instructions.

COMPASS

A compass assists in navigation by indicating where approximate north is located. See the manufacturer's instructions for operating instructions.

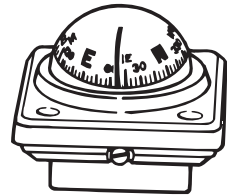

KC-0107-A

ENGINE WARNING ALARM SYSTEM

The engine may have integrated audible alarms to warn of engine overheating, low oil pressure or other conditions. See the *Engine Operator's Manual* for more information.



HELM AND CONTROL SWITCHES

The following information is intended as basic and typical and may not apply to your specific application. Not all switches may be covered in this section. See the *Manufacturer's Operator's Manual* for specific information on the use and operation of switches in the boat.

Many of the electrical features and systems in the boat are equipped with a control switch and protected with breakers or fuses. Switches are designed for different applications and found in many styles and shapes. Some switches may have a lighted indicator for easy ON/OFF identification. Some switch panels contain a master power switch that controls power to all circuits.

IGNITION SWITCH

The ignition switch controls the engine starter circuit, the engine ignition system and accessory circuits connected to the ignition switch.

BLOWER SWITCH

The blower switch is used on boats that use an engine within an engine compartment, such as sterndrive and inboard engines. The switch controls power ON/OFF to the engine compartment ventilation blower to remove explosive fumes from the engine and bilge areas.

You must operate the blower for a minimum of four minutes before each time the engine is started.



WARNING

Fire/Explosion Hazard: If equipped with a bilge blower switch, always operate the bilge blower for a minimum of 4 minutes prior to starting the engine. Gasoline vapors can explode, resulting in injury or death.



BATTERY SWITCH

Battery switches are used to control battery power distribution and disconnect the batteries from the boat's electrical system. Battery switches are designed in many styles and for different applications. They generally provide battery isolation when used with multiple batteries and are used primarily as a method of quick and positive battery disconnection. Battery switches also protect against tampering, electrical fire hazards and battery drain. Keep this switch off when not using the boat or when storing it for extended periods of time.

NOTICE

Do not turn off the battery switch with the engine running; this could damage the engine's charging system.

Consult a qualified, knowledgeable technician for proper operation of the boat's specific electrical system.

ONE BATTERY

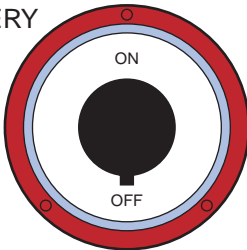

TWO BATTERIES

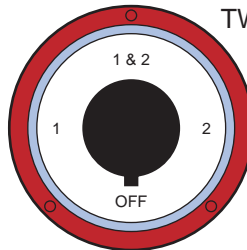

TYPICAL BATTERY SWITCHES

KCB-0006

OFF Position - Neither of the batteries are connected to the engine's starting or charging systems. The switch should be in the OFF position when the boat is not being used to ensure that the batteries do not lose their charge. The switch should also be in the OFF position when an external battery charger is being used to charge the battery(s) to avoid possible damage to the electronic components on the engine or in the boat.

NOTICE

Do not turn the battery switch to any other position with the engine running; this could damage the engine's charging system.

"1" Position - This is usually the main battery. Normally when the battery switch is not OFF, it should be set on 1.

"2" Position - This is usually the auxiliary, house or backup battery. This position should only be used if battery 1 has become depleted and the reserve battery is needed to start the engine.

“1+2” Position - The switch may also be labeled “both” or “combined.” This position would be used in an emergency situation where both batteries are low and power is needed from both batteries to start the engine. Once the engine has started, carefully select battery 1 or battery 2 (but not OFF) to direct all of the charging current to one battery.

NOTICE

If the battery is dead or severely undercharged, do not use the engine charging system’s alternator to bring the battery to a fully charged condition. The excessive current draw can overheat the alternator and cause it to fail. If you have a dead battery, use an external battery charger to bring the battery to a fully charged condition.

ENGINE EMERGENCY STOP SWITCH AND LANYARD

The engine emergency stop switch controls the engine ignition ON/OFF. This safety device shuts the engine off immediately and prevents the boat from becoming a runaway if the operator is accidentally thrown from the seat or away from the helm.

Whenever the boat’s engine is on, physically secure one end of the emergency engine stop switch lanyard to the emergency stop switch and the other to the boat operator. If the operator is thrown from the seat or moves too far from the helm, the lanyard will disconnect from the switch, activating the switch to turn off the engine.

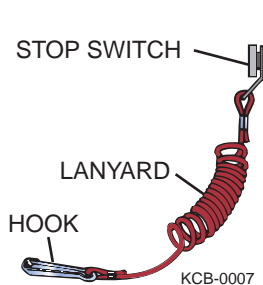
**WARNING**

Control Hazard: Never remove or modify the engine emergency stop switch and/or lanyard.

- **Always check the switch for proper operation. With the engine running, pull the lanyard. If the engine does not stop, have the switch repaired before continuing to operate the boat. Never operate the boat if the engine emergency stop switch does not work.**
- **Attach the engine stop switch cord lanyard to a secure place on your clothing, your arm or leg while operating.**
- **Avoid accidentally pulling the cord lanyard during normal operation. Loss of engine power means loss of most steering control. Also, without engine power, the boat could slow rapidly. This could cause people and objects in the boat to be thrown forward.**
- **DO NOT attach the cord lanyard to clothing that could tear loose. DO NOT route the cord lanyard where it could become entangled, preventing it from functioning.**



NEUTRAL START SAFETY SWITCH (START-IN-GEAR PREVENTION)

The neutral start safety switch provides start-in-gear prevention. The switch controls power to the engine starter circuit of the ignition switch. The engine gear shift control lever must be in the NEUTRAL position to allow the ignition switch to activate the engine starter. This safety device will prevent the boat's engine from starting if the engine is in gear.

HORN SWITCH

The horn switch controls power ON/OFF to sound the horn.

BOARDING AND COURTESY LIGHT SWITCHES

The boarding and courtesy switches control power ON/OFF to boarding lights and cockpit courtesy lights.

POWER TRIM / TILT SWITCH

The power trim/tilt switch controls power ON/OFF to the engine's power trim/tilt electric hydraulic pump. This switch is usually a three-position switch, with OFF in the center. If engine is equipped with power trim and tilt, this system allows you to raise and lower the lower drive unit and propeller to adjust trim (the planing, and running angle of the boat while underway).

The tilt feature positions the lower drive unit up beyond the power trim range and is used for trailering, launching or beaching. Never use power tilt when the engine is running.

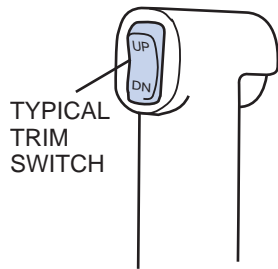

KC-0108-A

NAVIGATION LIGHTS SWITCH































The navigation lights switch controls power ON/OFF to the boat's navigation, running and anchor lights. This switch is usually a three-position switch, with OFF in the center. When the switch is in the NAV position, the red and green navigational, white stern and running lights, and console gauge lights are activated. When the switch is in the ANC position, only the white stern light is activated.

Never operate the boat between sunset and sunrise using only the stern light. Use all navigational lights when operating underway between sunset and sunrise.

BOAT FEATURES AND OPTIONS



SYMBOLS

BASE SYMBOLS				
				
Boat	Boat Profile	Engine	Tank	Light
SWITCH SYMBOLS				
				
Interior Light	Anchor Light	Navigation Light	Engine Room Blower	Bilge Pump
				
Windlass	Depth Finder	Windshield Wiper	Windshield Washer	Horn
ENGINE SYMBOLS				
				
Ignition	Hour Meter	Engine Key	Engine Stop	Engine Alert
TANK & BATTERY SYMBOLS				
				
Fuel	Waste Holding	Freshwater	Battery	Battery Parallel
OTHER SYMBOLS				
				
Sling Point	Lift Point	Fuel	Diesel Fuel	Safety Alert



SECTION

9

BOAT FEATURES AND OPTIONS

This Page Intentionally Left Blank

Section 10

GENERAL CARE AND MAINTENANCE

The boat may feature a variety of specialized systems and components. The following basic and typical information may not apply to your specific application. This section may not cover all systems or components on the boat. See the *Engine Operator's Manual* or the equipment manufacturer's information for maintenance procedures.

Maintenance procedures may require special knowledge and equipment. Always consult the boat dealer for assistance in performing service, maintenance or modifications to the boat.

Neglect of maintenance and unauthorized service work is not recommended and may void your warranty. Refer to the *Engine and Equipment Manufacturer's* maintenance schedules and requirements, and keep a detailed log of the procedures and dates completed. Always consult the boat dealer for assistance with periodic maintenance.

Before performing any general care and maintenance procedures within this section, review *Safety in Section 2*.

ENGINE

The manufacturer of the boat's engine(s) will provide a separate maintenance procedure. See the *Engine Operator's Manual* for specific information on maintenance procedures.



SECTION
10 GENERAL CARE AND MAINTENANCE

FUEL SYSTEM

 **WARNING** *Fire/Explosion Hazard: Gasoline is extremely flammable and highly explosive under certain conditions.*

Be sure to check the fuel hoses and connectors for leaking and deterioration before fueling and on a monthly basis. Fuel system repairs should only be performed by a marine technician certified in fuel systems.

Check and/or replace the fuel filter periodically or clean as needed. Check fuel lines, vent hoses and drain hoses frequently for leaks. Replace any worn or cracked hoses.

Tightening a fitting or clamp may correct a fuel leak. If the leak continues, however, replace the line, fitting or hose immediately to prevent a build-up of fluids or gases.

Use fuel system parts certified for marine use only. Never use automotive parts in marine applications.



CARBON CANISTER SYSTEM DIRECT FILL

99TDF100-1



CAUTION

The vessel manufacturer must comply with the requirements of CFR 40 1060.202. Any questions can be directed to www.attwoodmarine.com. Failure to follow these instructions may result in accidental fuel system over-pressurization. Users must follow these instructions to ensure vessel function and operation.

EMISSION-RELATED INSTALLATION INSTRUCTIONS

Failing to follow these instructions when installing the Attwood Carbon Canister System Direct Fill in a piece of nonroad equipment violates federal law (40 CFR 1068.105(b)), subject to fines or other penalties as described in the Clean Air Act.

FEATURES:

The Attwood Carbon Canister System Direct Fill is sturdy, non-corrosive plastic. Bonding and grounding are not required because they are non-metallic. The Direct Fill cap is water resistant when secured correctly; turned until an audible sound is heard. They meet all requirements for ISO 10080, ABYC, and USCG.

The Carbon Canister Direct Fill is not certified for diurnal emission control. The use of a certified Carbon Canister for proper diurnal emission control is required to meet EPA diurnal emission control requirements. The Attwood Direct Fill is equipped with over-pressure relief valve. This valve is intended only to prevent the accidental over-pressurization of a fuel system and is a safety device only, not for use as diurnal emission control devices.

TAKE THE FOLLOWING STEPS TO ENSURE LIQUID FUEL AND/OR LIQUID WATER DOES NOT REACH THE CARBON CANISTER

1. Install Attwood 99FL and/or 99GV series vent valves in the vent line between the liquid fuel reservoir and the Carbon Canister. Install the Attwood 99FL vent valve between the carbon canister and any 99GV series vent valves. The Attwood 99FL and 99GV series valves have been validated to ensure liquid fuel does not reach the vent line and/or the Carbon Canister during vessel storage, operation and maneuvering due to sloshing, filling or expansion of the fuel. Follow all installation instructions for the 99FL series Fill Limit Vent Valves and 99GV series Grade Valves to ensure safe and proper function. The Attwood carbon canister can be mounted in any relative position to the fuel tank when Attwood 99FL and Attwood 99GV series valves are installed in the vent line between any liquid fuel reservoir and the Attwood Carbon Canister.



SECTION
10

GENERAL CARE AND MAINTENANCE

NOTE — Installations relying upon self-draining vent/fuel lines as the method of preventing liquid fuel from reaching the canister do not meet the criteria for preventing liquid fuel from reaching the carbon canister.

2. In order to prevent liquid water from reaching the carbon canister, install Attwood 1674 Series P-trap Vent in the vent line after the Carbon Canister. Follow all installation instructions for the Attwood 1674 Series P-trap Vent.

IMPORTANT SAFETY INSTRUCTIONS (FOR ALL ATTWOOD 99FL/99GV/99DF/99CC/99DV/99TDF COMPONENTS)

1. Install the Attwood 99TDF100-1 Carbon Canister System Direct Fill to prevent the accidental wellback of fuel. No other fuel fill valves should be installed in order to ensure the safety of the fuel system and vessel. The Attwood 99TDF100-1 Carbon Canister Direct Fill includes features to allow vapor and liquid to pass the valve in order to ensure the system does not become accidentally over-pressurized.
2. Install an Attwood 99FL Series Fill Limit Vent Valve in the vent line between the liquid reservoir and the deckfill vent in order to prevent the accidental wellback of fuel.

MOUNTING LOCATION AND REGULATIONS

Select location that meets these conditions:

1. Conforms to all ABYC, U.S. Coast Guard, and EPA regulations. (See end of this document for information availability.)
2. In an area where spilled fuel cannot enter the boat.

INSTALLATION INSTRUCTIONS

1. Secure Direct Fill by rotating assembly clockwise to 12 N-m (9ft/lb) torque then continue clockwise rotation to next Anti-Backout tooth clicks past the Tab. The use of a strap wrench is acceptable.
2. Pressure test tank to ensure connection integrity, per CFR 33 183.580, at a pressure of 3 psi for no less than 5 minutes. Inspect all connections for leak by method other than pressure decay.
3. If leaks occur, rotate the cap clockwise until the second Anti-Backout tooth clicks past the tab (preferred position).
4. Pressure test tank to ensure connection integrity, per CFR 33 183.580, at a pressure of 3 psi for no less than 5 minutes. Inspect all connections for leak by method other than pressure decay.
5. If a leak occurs, rotate cap clockwise until the third Anti-Backout tooth has clicked past the Tab.



6. Pressure test tank to ensure connection integrity, per CFR 33 183.580, at a pressure of 3 psi for no less than 5 minutes. Inspect all connections for leak by method other than pressure decay.
7. If a leak occurs, rotate cap clockwise until the fourth Anti-Backout tooth has clicked past the Tab.
8. Pressure test tank to ensure connection integrity, per CFR 33 183.580, at a pressure of 3 psi for no less than 5 minutes. Inspect all connections for leak by method other than pressure decay.

NOTE — During pressure test be sure to keep cap unsubmerged and dry.

CARE AND MAINTENANCE

Care should be taken, when cleaning the boat, to prevent contaminating the valves and direct fill. Cleaning with only mild soapy water is recommended. All connections should be checked annually.

MANUFACTURER REQUIREMENTS

The information below applies only to EPA CFR 40 1060.135. The vessel manufacturer is responsible to meet all additional regulatory labeling requirements including EPA, CARB, USCG and others as necessary. The below information is for reference only. The vessel manufacturer should refer to CFR 40 for complete labeling guidelines.

In order to meet the requirements of CFR 40 1060.135, the vessel must be labeled with respect to evaporative emissions in the following manner when installing certified components;

Excerpt from CFR 40 1060.135

(a) You must affix a permanent and legible label identifying each engine or piece of equipment before introducing it into U.S. commerce. The label must be—

(1) Attached in one piece so it is not removable without being destroyed or defaced.

(2) Secured to a part of the engine or equipment needed for normal operation and not normally requiring replacement.

(3) Durable and readable for the equipment's entire life.

(4) Written in English.

(5) Readily visible in the final installation. It may be under a hinged door or other readily opened cover. It may not be hidden by any cover attached with screws or any similar designs. Labels on marine vessels must be visible from the helm.



SECTION
10 GENERAL CARE AND MAINTENANCE

(b) If you produce equipment without certifying with respect to evaporative emissions, the equipment label specified in paragraph (a) of this section must—

(1) State: “MEETS U.S. EPA EVAP STANDARDS USING CERTIFIED COMPONENTS.”

(2) Include your corporate name.

Below is an example of a label specified by CFR40 1060.135 for use with certified components;

**MEETS U.S. EPA EVAP STANDARDS USING
CERTIFIED COMPONENTS**

CORPORATE NAME

Please refer to CFR 40 1060.135 to review EPA vessel labeling requirements.

The NMMA has a program to supply OEM builders with labels. Please refer to the NMMA website below for further information regarding the NMMA label program;

www.nmma.org/certification/products/labelsanddecals.aspx

TWO-YEAR WARRANTY & LIABILITY

Generally: Attwood Carbon Canister System Direct Fill is covered by a two (2) year limited warranty from the date of a Vessel’s first retail sale.

Pre-requisites to Warranty Eligibility: For the warranty coverage described herein to apply, the following conditions must be met:

- Component must have been properly installed per Attwood installation instructions; and
- The component cannot have been altered or abused by Boat Company or its customers.

Warranty Terms for Components:

Attwood warrants that any Attwood Carbon Canister System Direct Fill is free from defects in materials and workmanship and are designed, built, and equipped to conform at the time of sale to Boat Company with the 40CFR.1060 requirements. For two (2) years from the date of the vessel’s first retail sale, Attwood will, at its sole option, repair or replace any components that fail due to a defect in material or workmanship. ATTWOOD PROVIDES NO WARRANTIES WITH RESPECT TO ANY PART OR COMPONENT NOT MANUFACTURED BY ATTWOOD, INCLUDING FUEL TANKS. Boat Company is responsible for the installation of all Systems, whether installed by Boat Company or under its direction.

GENERAL CARE AND MAINTENANCE

SECTION

10



A.B.Y.C.

American Boat & Yacht Council
3069 Solomon's Island Road
Edgewater, Maryland 21037
www.abycinc.org

E.P.A.

401 "M" Street, SW
Washington, DC 20593
www.epa.gov

**National Marine
Manufacturers
Association (NMMA)**
231 S. LaSalle Street
Suite 2050
Chicago, IL 60604
www.NMMA.org

U.S. Coast Guard

Washington, DC 20460
www.uscgboating.org

ISO

iso.org

**Emission-Related Installation Instructions:**

Failure to follow these instructions when installing an Enviro-Fill® pressure relief vent valve in a piece of non-road equipment violates federal law (40 CFR 1068.105(b)), subject to fines or other penalties as described in the Clean Air Act. Equipment manufacturers installing these components must comply with the requirements of (40 CFR 1060.202)

General Requirements:**Tank sensor/vent assembly**

- The fitting should be located in the fuel tank in a position determined by the tank manufacturer to trigger the automatic shutoff of the fueling nozzle in accordance with the recommendations contained in ABYC H 24.
- The Tank sensor/vent assembly shall be grounded to the vessel's ground system in accordance with the recommendations contained in ABYC H 24.
- The fitting and connections shall be readily accessible.

Deck Fill

- The deck fill may be mounted at any location in accordance with the recommendations in ABYC H 24.

NOTE — if the deck fill fitting will be below the level of fuel in the system at any point when tested according to ABYC H 24 18.4 or when subjected to dynamic forces during operation of the boat then a remote vent valve must be used.

- The deck fill may be mounted with the axis, of the fill, ranging from vertical to 60 degrees from vertical.
- The deck plate and venturi tube shall be grounded to the vessel's ground system in accordance with the recommendations contained in ABYC H 24.
- The fitting and connections shall be readily accessible.



Mounting of Components:

Tank sensor/vent assembly

-The tank sensor/vent assembly must be mounted to the tank using (5) # 10 screws that correspond to (5) threaded inserts molded into the tank with the gasket provided.

-A marine ring terminal on one of the mounting screws should be used to connect the fitting to the vessel's ground system; the ground system must comply with ABYC H 24.

-Pressure testing according to ABYC H 24 must be performed to insure there are no leaks associated with the system.

Deck Fill

-Make sure there is sufficient room for the deck fill and required hoses below the mounting surface.

-The deck plate should be mounted on a flat surface with #10 screws of an appropriate length for the application.

Mounting of Components (cont):

Deck Fill (cont)

-A marine ring terminal is recommended to connect the boats ground to the ground screw on the side of the deck plate. This ground screw must be used to connect the venturi ground wire and the deck plate to the vessel's ground system; the ground system must comply with ABYC H 24.

Remote vent valve

-The remote vent valve must be installed in the vent hose at a point that will not be below the level of fuel in the system when tested according to ABYC H 24 18.4 or when subjected to dynamic forces while the boat is in operation.

NOTE — All hoses must be supported in a way that prevents excess load on the fittings and connections.

NOTE — Any caps or plugs must be removed from hose barbs before connecting the hoses.



SECTION
10 GENERAL CARE AND MAINTENANCE

System Configurations:

-The fill hose shall be run as directly as is practical from the deck fill fitting to the tank so that the hose always drains back to the tank (self-draining)

-The tank vent hose shall be run as directly as is practical from the vent barb on the tank sensor assembly to the appropriate fitting on the deck fill fitting so that the hose always drains back to the tank (self draining)

-Any T's or Y's used to connect multiple vent connections should be tied into the vent hose above the highest level of tank sensor assembly when tested according to ABYC H 24.18.4.

NOTE — when using a remote vent valve it must be installed so there is an unrestricted passage from the vent barb on the tank sensor assembly to the vent barb on the deck fill fitting.

- The overboard vent hose shall be run as directly as is practical from the overboard barb on the vent valve to the overboard.

-The pressure transfer hose shall be run as directly as is practical from the pressure transfer barb (the small one) on the tank sensor assembly to the venturi barb near the bottom of the deck fill so that the hose always drains back to the tank (self-draining).

The Enviro-Fill® system is offered in several configurations to meet the requirements of boat builders. Typical configurations are shown in Fig 1-4.

When using pressure relief technology (40CFR 1060.240(e)(1) for diurnal control to meet the requirements of (40 CFR 1060.105(b) use either EF469, EF479, EF569, or EF579 Enviro-Fill® for pressurized fuel systems installed according to the prior installation instructions.

The system must use an EPA certified cap installed using the tether attached to the deck plate as described in 1060.101(f)(1)

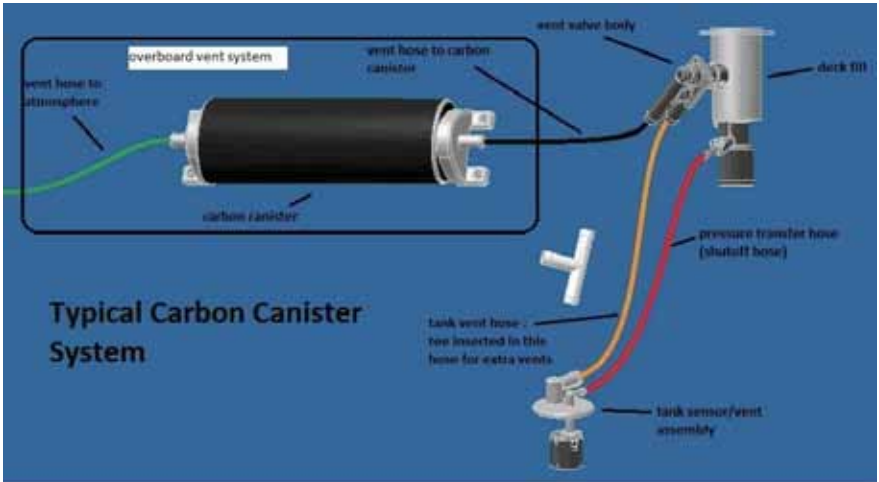

Figure 1

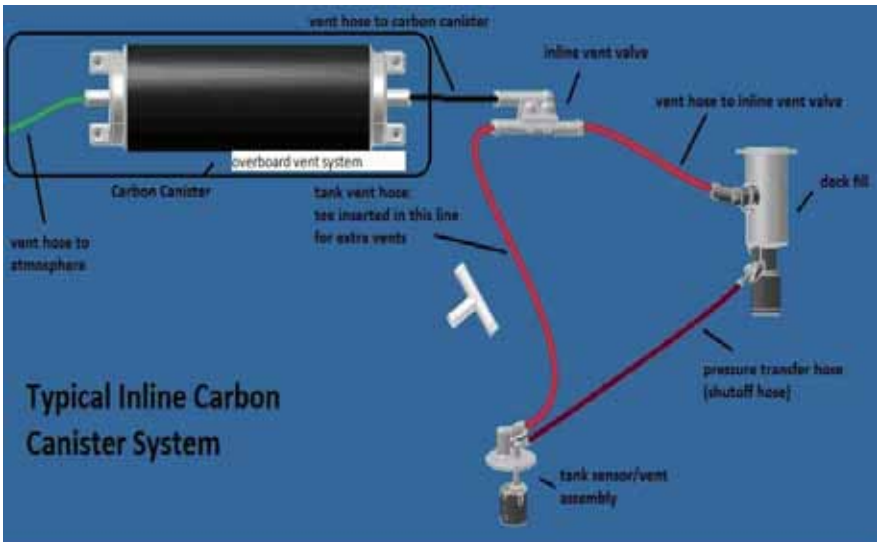

Figure 2

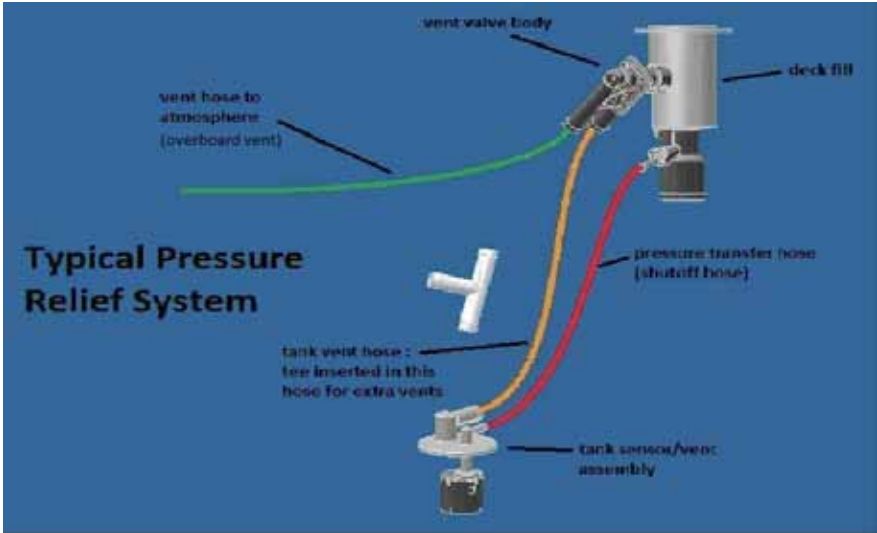

Figure 3

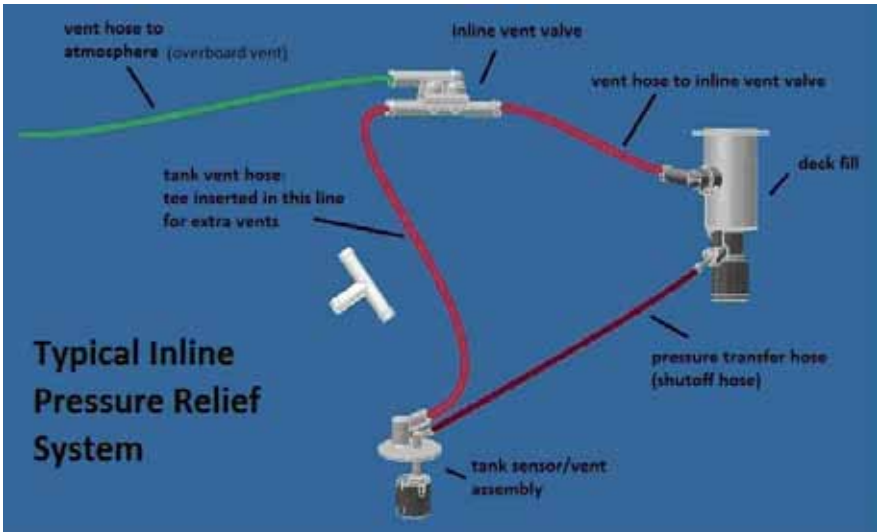

Figure 4



ELECTRICAL SYSTEM

Before performing any work on the electrical system or the battery, review *Safety in Section 2*.

BATTERIES



WARNING

Electrical Shock Hazard: Always disconnect the batteries before performing maintenance on the DC electrical system. Electrical shock may occur if the batteries are not disconnected during maintenance on the DC electrical system.



WARNING

Personal Injury Hazard: Always wear gloves and protective eyewear when working on and around the batteries. The batteries contain an acid called electrolyte. Avoid causing damage that could spill electrolyte into the bilge when servicing the batteries. Avoid getting salt water in or on the battery. Either condition can create a poisonous gas that is harmful if inhaled. Always disconnect the batteries before cleaning.



CAUTION

Personal Injury Hazard: Never allow a tool to bridge across the battery terminals. Injury can result if the terminals are accidentally bridged with a tool or other conductor.

Today's boats can be loaded with electronics that all run off the boat's battery. Because of this, many boats will have two or more batteries: one for starting and running the engine, and one for electronics, commonly referred to as the house battery. One advantage is that the starting battery will not be drawn down when using electronics with the engine off, such as with a stereo. Another advantage is if the starting battery has lost capacity because of age, the battery switch has a 1+2 (Both) position that parallels both batteries for emergency starting. See the *Blower Switch* section of this manual for more information.

Marine batteries generally come in two types: starting and deep-cycle. Starting batteries are similar to car batteries, can supply lots of current for a short period of time and are used for starting the engine. Starting batteries should be recharged almost immediately and do not tolerate deep discharges. Deep-cycle batteries are designed for repeated discharging and recharging cycles without damage. They are used as the house battery on boats with higher DC power requirements.

All batteries have one thing in common — they run for a while, need recharging and require an eventual replacement as the capacity fades. Most marine batteries are sealed and require no maintenance other than keeping them at a full state of charge and diligently cleaning corrosion from the terminals. To maintain long life, deep-cycle batteries should not be discharged more than 50% before they are recharged.



Most marine batteries are flooded, sealed lead-acid, but there are several different battery types/chemistries that could be used. You must use caution when charging or replacing the batteries; replace batteries with the exact same type, group and capacity. If your boat is not equipped with an onboard battery charger, use a smart charger suitable to your battery type/chemistry.



CAUTION *Burst Hazard: Never use an automotive type (lead-acid) battery charger to charge a gel cell type battery. Doing so will cause damage to both the charger and battery and can cause the battery to burst. Use a battery charger specifically designed to charge gel cell type batteries.*

Always turn off the battery switch (if equipped) or disconnect the negative battery cable before servicing the electrical system.

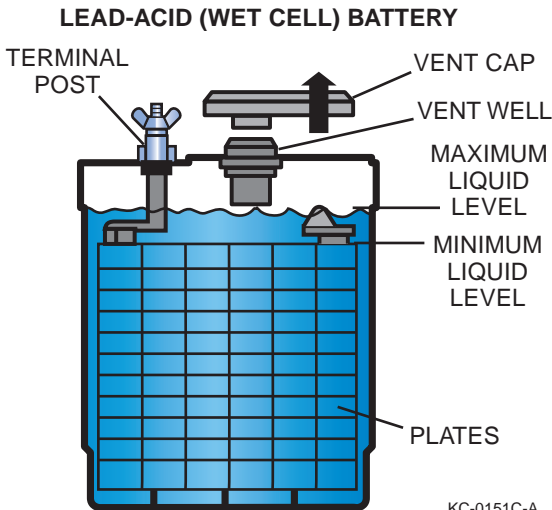

When you install a battery:

- Make sure the battery terminals are clean.
- Be certain to use correct polarity when you connect the battery cables to the battery.
- Make sure the cable connections are tight.
- Always shut down the engine before removing or attaching battery cables and never run the engine with the battery cables disconnected.
- Always remove the negative (-) cable first. Always attach the negative (-) cable last.



Check the battery frequently for signs of corrosion. If corrosion is evident, clean the terminal posts with a baking soda and water solution and a wire brush. Disconnect the battery terminals before cleaning.

**WARNING**

Burn Hazard: Lead-acid battery fluid can cause severe burns.

Check the fluid levels in the cells.

NOTICE

Some batteries are sealed and cannot be filled. A level of approximately 1/4 to 1/2 in. (6 to 13 mm) above the plates is sufficient. If needed, fill with distilled water; do not overfill.

During extended periods of non-use, batteries will self-discharge and should be recharged. Before recharging, disconnect the battery terminals and remove the battery from the boat. Recharge the battery according to the directions enclosed with the battery and battery charger. When installing the battery in the boat, make sure the battery is secured in the battery box, the terminals are tight and all protective covers are in place.

**WARNING**

Fire/Explosion Hazard: Hydrogen gases produced by a lead-acid battery while it is charging, or the engine is running, can cause a fire and/or an explosion.

CIRCUIT BREAKERS AND FUSES

Never exceed the recommended fuse sizes or bypass a fuse in a circuit. Always install the proper (type and rating) fuses whenever replacing or changing fuses. Continuous fuse/breaker failures indicate a severe problem and require immediate attention.

**WARNING**

Fire Hazard: Never reset a circuit breaker that has been automatically tripped or replace a fuse that has blown without first identifying and correcting the cause of the problem. Failure to correct the cause may result in a fire hazard.



TYPICAL BREAKER / FUSE PANEL



KC-0247C-A

Some applications use circuit breaker switches to provide individual circuit protection with the ability to manually reset the breaker switch.

To reset a tripped circuit breaker, move the breaker switch to OFF. Identify and correct any problems with the circuit and unplug all loads connected to it. Wait a minimum of one minute for the breaker switch to cool and then push the breaker switch to ON. Turn the breaker switch to OFF immediately if it trips, and consult qualified personnel.

To replace a fuse, locate the fuse block and the failed fuse. Carefully remove the fuse without touching other fuses or wires. When possible, use a fuse removal/installation tool. Some accessories have in-line fuses accessible inside the helm or near the battery.

**WARNING**

Fire Hazard: DO NOT exceed the recommended fuse sizes or bypass the fuse safeguard. Always install the proper (type and rating) fuses whenever replacing or changing fuses.

NOTICE

A boat's electrical system is designed to protect you from electrocution, short circuits and overloads. Have a qualified electrician perform any modifications to the system such as adding electrical accessories. Some installed accessories, such as stereos, have an additional fuse located in-line with the positive lead. Other accessories may use in-line fuses near the battery.



GALVANIC CORROSION

Galvanic corrosion (electrolysis) is the deterioration of metals from the effects of electrolytic action. When two dissimilar metals are immersed in a conductive fluid such as salt water, an electric current is produced, much like a battery. As current flows between the two metals, the softer, or sacrificial, metal deteriorates.

If you operate in salt, polluted or brackish waters, the boat should be equipped with a transom-mounted sacrificial anode to prevent corrosion damage to other metal parts of your boat that are in contact with the water. The anodes are self-sacrificing and are slowly eroded by electrolytic action. These anodes are important and require periodic inspection for deterioration. Replace the anode when it is less than 50% of its original size.

Most engines are equipped with one or more anodes that require periodic inspection. See the *Engine Operator's Manual* for maintenance procedures.

Electronic cathode systems are designed to reduce the effects of electrolysis. Electronic cathode systems emit an electrical low-current charge into the water near the metal components' neutralizing electrolytic action.

NOTICE

Do not paint or coat sacrificial anodes or cathodes with any substance. Once covered, they do not provide protection from galvanic corrosion. Replace anodes if they have deteriorated 50% or more.

SALTWATER CORROSION

Any boat exposed to salt water can be affected by the salt. However, to minimize the effects of salt water on aluminum boats, consider the following preparation and maintenance.

If you plan to use your boat in salt water, all portions of the boat that will be submerged should be painted with an approved aluminum anti-fouling paint. This service is provided by your dealer or by someone recommended by your dealer. There is an extra charge for this service.

If you trailer your boat and use it in salt water, be sure that the bottom of the boat has a barrier between it and the bunks. If anti-fouling paint is not used, salt water trapped in the trailer bunks can cause corrosion at the point where the trailer bunk meets the hull.

In some cases you may need to have sacrificial anodes added to your boat to prevent electrolysis. Ask your dealer whether he recommends adding anodes. There is an extra charge for this service.

SECTION 10 GENERAL CARE AND MAINTENANCE

Maintenance

Removing saltwater deposits from the boat as quickly as possible is the key to keeping saltwater corrosion in check.

- Rinse the boat hull and deck with fresh water and wash immediately after using the boat in salt water. Allow the boat to dry before covering it with the mooring or seat covers.
- If you trailer your boat you MUST flush the salt water from in between the bunks and the pontoons. This does not prevent corrosion but only mitigates it if no anti-fouling paint is applied.
- You should repair paint chips and scratches when you start to notice bare metal showing.
- Cover your boat WHEN DRY with seat covers or a mooring cover to keep salt and weather off of your boat. Since most saltwater areas are very humid it is imperative that the boat be dry before it is covered. If you cover it wet you will see mildew develop.
- A yearly inspection for corrosion or deterioration of the electrical connections is recommended.
- If the boat is used primarily in salt water, wax the hull monthly and apply corrosion inhibitor to all hardware.
- Flushing the engine cooling system is recommended when the engine has been used in salt, polluted or brackish waters. Flush the entire engine cooling system with fresh water for at least 5 minutes after use in these waters. See the *Engine Operator's Manual* for the flushing procedure. Consult the boat dealer for suitable flushing equipment.

SACRIFICIAL ANODES

Anodes (sometimes called “zincs”) are used to protect hardware exposed to the water. Since galvanic corrosion attacks the least “noble” metals first, less noble metal anodes are used to purposefully “sacrifice” themselves, thereby protecting the more noble metals of the drives, propeller, tabs, boarding platform and other metal items below the waterline (such as underwater gear).

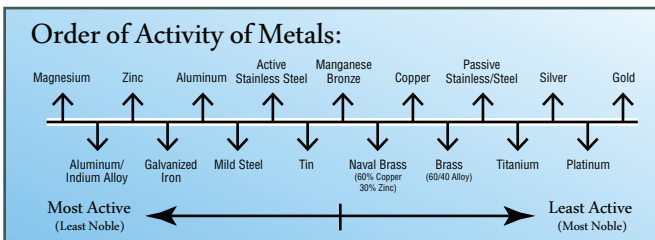

KC-6009



Anodes may be installed on the boat transom and/or bottom at the factory. Additional anodes may be installed on the underwater gear as well as any metal components exposed to raw water, such as heat exchangers and water cooling jackets. Anodes are made in three different metals which must be matched to the water type and local conditions. Most boats are equipped from the factory with zinc anodes on the recommendation from engine and drive manufacturers. The anodes that are installed on the trim tabs are typically zinc and are isolated from the boat bonding system.

Selection, monitoring and replacement of the anodes on the transom, drives, trim tabs, boarding platform supports and other underwater gear is the customer's maintenance responsibility. Any damage done because of lack of maintenance will not be covered under warranty.

WATER TYPE	ANODE MATERIAL	REPLACE AT
Salt water	Zinc	40% decomposition
Brackish water	Aluminum	50% decomposition
Fresh water (clean)	Aluminum/magnesium alloy	50% decomposition
Fresh water (polluted)	Magnesium	40% decomposition

NOTICE

To be effective, anodes must be bare metal. If the boat is dry-docked more than 24 hours, sand the anodes to clean oxidation from the surface.

- *Zinc and aluminum anodes left in fresh water or zinc anodes used in brackish water will become covered with white oxide which effectively stops the sacrificial process and exposes the underwater gear to damage.*
- *Do not paint sacrificial anodes. Bottom paints/sealants on anodes will block the sacrificial process and expose the underwater gear to damage.*
- *Depending on local conditions, some anodes can deteriorate very quickly and must be closely monitored. See the boat dealer for recommendations.*



Because of the vital function that anodes play in the protection of underwater gear, replace anodes at the recommended level of decomposition, or annually, with the correct type. Boats stored in salt water will normally need to have the anodes replaced every 6 months to one year. Anodes requiring replacement more frequently may indicate a stray current problem within the boat or at the slip or marina.

Anodes that do not need to be replaced after one year may not be providing the proper protection. Loose or low-quality anodes could be the problem. There could also be a problem in the bonding system or the wrong anode material is being used.

The boater/customer has the responsibility in maintaining and ensuring that the proper anodes are installed for the area (water) in which the boat will be used. See the boat dealer about changing material or adding additional anodes.

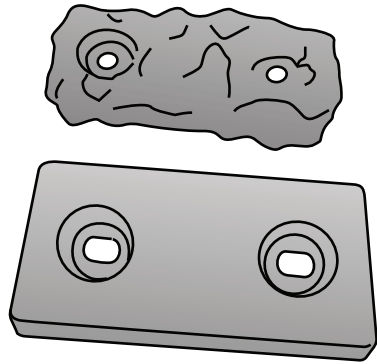

KC-6006



STEERING SYSTEM



WARNING

Control Hazard: Improper maintenance of steering system is hazardous and can cause death or serious injury from sudden loss of control. Ensure all steering hardware, cables and grease fittings are regularly inspected and maintained. If any steering problems are noticed, do not operate the boat and contact your dealer immediately for service assistance.

Inspect and maintain the boat's steering system regularly. Frequently check the hardware at the helm, engine or rudder end for tightness. See the *Engine Operator's Manual* or the steering manufacturer's information for the appropriate torques.

TYPICAL HYDRAULIC STEERING SYSTEM

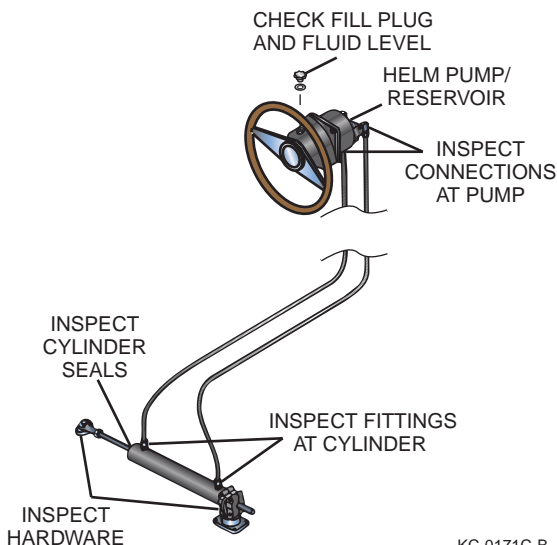

Make sure hydraulic hoses are tight and leak-free. Check cylinder seals for dampness, which indicates leaking. Check the fluid reservoir monthly and top off if necessary. See the steering system manufacturer's information for more details.

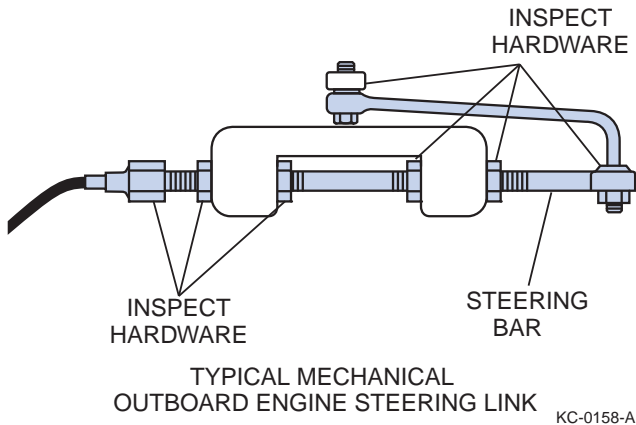

CORROSION PROTECTION

HARDWARE, FASTENERS AND FITTINGS

Check all fasteners, fittings, hinges, latches, rails and cleats for corrosion and tightness. Repair or replace any items that need attention. Never use automotive replacement parts when replacing marine parts.

Periodically clean all hardware with approved marine cleaners or mild soap and water. Never use abrasive cleaners or materials; they will scratch the polish and protective coatings on the hardware and cause the hardware to corrode. Applying a coating of marine-grade wax can help maintain the original shine of the hardware and help prevent corrosion.

STAINLESS STEEL AND CHROME HARDWARE

Stainless steel and chrome will normally oxidize over time, especially in marine environments. Cleaning and preventive maintenance of stainless steel and chrome hardware are crucial in maintaining appearance and functionality. If the hardware is left unattended, it can corrode, causing the hardware to appear unsightly and cause structural integrity problems.

Wash the stainless steel and chrome hardware with mild soap and water after operating the boat in corrosive environments such as salt water.



Remove rust or corrosion promptly by cleaning the hardware using a high-quality stainless steel, chrome cleaner or conditioner. Do not use any abrasive materials such as steel wool or sandpaper to clean the hardware. Do not use acids or bleach or any cleaners not intended for stainless steel or chrome, such as glass, tile or counter cleaners, as these types of cleaners can cause permanent damage. Always test a cleaner in an inconspicuous area first before applying to the complete surface.

After cleaning, protect the surface of the hardware by using a high-quality boat, automotive, stainless steel or chrome protectant or wax.

ALUMINUM HARDWARE

Periodically wash aluminum hardware with soap and water to keep it clean. If the boat is used in salt water or polluted water, wash aluminum hardware with soap and water after each use. Salt water allowed to remain on aluminum will penetrate the metal and corrode the aluminum.

It is recommended to frequently clean and coat all aluminum hardware with a metal protectant made for aluminum to protect against pitting and corrosion caused by the harsh effects of salt water. Choose an appropriate cleaner specific to your needs, as special cleaners are available for different types of aluminum hardware such as anodized, powder coated and polished.

Most stains can be removed from aluminum with a metal polish or fine polishing compound. To minimize corrosion, use a caulking compound or Teflon-based sealer to isolate hardware and fasteners mounted to aluminum fabrications. With proper care, aluminum hardware can provide many years of service.

GENERAL MAINTENANCE AND CLEANING



WARNING

Asphyxiation Hazard: Do not mix cleaning agents together; toxic vapors may be released. Read and follow safety-related precautions found on the product labels.

MARINE GROWTH

If accelerated marine growth is a problem in your area, an antifouling bottom paint may be necessary to slow growth and prevent gelcoat damage. Before selecting a bottom paint, talk to the boat dealer to determine which product works best in your area. Many local variables can affect the selection of paint. Be sure to follow the paint manufacturer's directions exactly.



SECTION
10 GENERAL CARE AND MAINTENANCE

CLEANING

Never allow any type of cleaning solution or cleaning material to come in contact with the water or be discharged into the water. The discharge of any type of debris or waste, including, but not limited to, food, trash, garbage, oil, fuel, liquids and human waste, is highly restricted, if not unlawful, in most waterways. Never discharge anything into the water.

Periodic cleaning is the best way to keep the boat looking new. Regular washing and waxing keep dirt, algae and water deposits from building up and deteriorating the finish. Keeping the boat in “show room” condition means greater personal satisfaction and higher resale value. Special cleaning products are available from the boat dealer.

HULL

When washing the boat, use a mild detergent with a warm water solution. Never use any kind of alkaline cleaners such as Tri-Sodium Phosphate (TSP), abrasive cleaners, solvents, ammonia or chlorine to clean gelcoat surfaces, as these will damage the gelcoat surface. Special cleaners are available from the boat dealer to remove marine growth and algae from the hull.

Wax gelcoat surfaces at least twice a season. Special marine gelcoat waxes are available from the boat dealer to prevent color fade and dirt adhesion. If the gelcoat has oxidized, chalked, dulled or faded from lack of proper maintenance, buffing may be necessary to bring back the shiny appearance. Hand buffing with #7 rubbing compound or power buffing with glazing compound #1 will quickly restore the surface; however, always seek certified assistance before attempting to restore your boat's finish.



UPHOLSTERY

Regular washing with mild detergent and warm water or non-solvent type automotive vinyl cleaner is sufficient to keep the cushions, canopy top and other vinyl coverings in good condition. Keep the cushions from becoming soaked and dry off thoroughly after washing to prevent mildew accumulation after the boat is covered. Position the cushions up in the boat when covered to allow air circulation and spray with mildew repellent.

NOTICE

High pressure washing will damage vinyl upholstery and flooring. Do not use a pressure washer on the interior of the boat for any reason or damage will occur.

For tough stains on vinyl such as adhesive and rust, use a citrus cleaner followed by a mild detergent and warm water. For ink stains, apply denatured alcohol and wipe off. Note that some products such as suntan lotion, shoe polish and wet leaves may stain permanently.

Although not always convenient, minimizing the boat's contact with damaging ultraviolet (UV) rays and storing removable seats and canopies indoors when not in use will increase the longevity of vinyl upholstery.

NOTICE

Certain automotive, household and industrial cleaners can cause further damage and discoloration. Be cautious when using solvents and dry-cleaning fluids, or products that contain dyes such as waxes. Whenever cleaning stubborn stains, test the treatment in an unseen area first. Use the following stain treatments with discretion. Between steps, be sure to rinse thoroughly with plenty of clean water and allow to dry.

BIMINI TOPS AND CANVAS COVERS (CANVAS)

Bimini convertible tops are mounted to the boat and can be raised into position for partial protection from sun and rain. Canvas covers are usually optional and can be attached to the bimini or other structure to offer additional protection and, in some cases, full protection from rain. Both types are made with synthetic materials and are usually referred to as “canvas.”

Canvas must be regularly maintained for long life and top performance. Moisture, dirt, ultraviolet rays and salt water can all contribute to the deterioration of canvas. These elements can cause serious damage if left unchecked. The following guidelines will help you keep your canvas in good condition for years to come:

- Always follow any written maintenance instructions from the canvas manufacturer.
- Canvas is not designed for extended exposure to the elements as a protective cover at dockside, for trailering, or when the boat is in storage. Use a full, properly fitted, light-colored mooring or trailering cover for these purposes.
- Occasionally set up all canvas and curtains, and hose down with fresh water to remove accumulated soot and dirt. Sweep or brush the underside of the canvas to prevent the accumulation of dirt and mildew.
- Wet canvas must be allowed to dry thoroughly before storage. Never allow canvas to dry loose since shrinkage can occur. Install and stretch all canvas fully on your boat when drying.
- Never allow the canvas to be exposed to direct sunlight for long periods of time or tree sap at any time.
- Use care when handling clear vinyl curtains and windows to prevent scratching. Never use cleaners on clear vinyl curtains and windows. Use clean water and a soft, clean microfiber cloth.
- If canvas gets wet during use, remove any side curtains and open the windshield to allow both sides and all seams to dry. The air circulation will allow all canvas to dry and prevent the growth of mildew. Never store wet or damp canvas.
- Never fold canvas where creases can form in the material. Loosely roll canvas to prevent damage.
- Never store canvas in plastic bags. Store dry canvas in a dry, well-ventilated compartment.
- Outer canvas surfaces can be cleaned with a soft scrub brush and either automotive convertible top cleaners or household cleaners suitable for use on vinyl surfaces. The underside of the canvas may be periodically sprayed with a spray disinfectant to prevent mildew.

GENERAL CARE AND MAINTENANCE

SECTION

10



- Lubricate snaps and zippers regularly. Vaseline, silicone spray or paraffin are effective lubricants. Never force snaps and zippers that are stuck.
- Never trailer the boat with the convertible top in the open position. Use the closed “trailing” position. Dismantle, roll and securely store all other canvas while trailering your boat to prevent wind damage.



BENN_0014

MOORING AND TRAILERING COVERS

A mooring cover is typically a lightweight nylon cover used when the boat is moored or docked on the water that can be quickly fitted on the boat. A trailering cover is a heavier canvas and can be securely fastened to the boat/trailer for highway use. Both types cover the entire boat and offer protection from sun, wind and rain. In most cases, boat covers receive more abuse than any other item on a boat due to exposure to the elements.

Covers should be regularly maintained for long life and top performance. Moisture, dirt, chemicals from industrial fallout, heat, ultraviolet rays, tree sap and salt water can all contribute to the deterioration of covers. Covers are recommended to protect your investment; the following guidelines will help you keep your covers in good condition:

- Always follow any written maintenance instructions from the cover manufacturer.
- Never use a mooring cover for trailering or winter storage.
- Never store or moor the boat under trees. Tree sap is very corrosive to covers and can also be harmful to gelcoat and vinyl interiors.
- Adjust cover top bows/poles to eliminate pockets in which rainwater can accumulate. The weight of accumulated water can collapse or damage the cover. Poles should be extended to maximum height possible.
- Wet canvas must be allowed to dry thoroughly before storage.
- Covers can be cleaned with a soft scrub brush and either automotive convertible top cleaners or household cleaners suitable for use on vinyl surfaces. The underside of the cover may be periodically sprayed with a spray disinfectant to prevent mildew.
- For best results when installing a cover, start with the aft corner on one side and then the bow corner on the same side. Then apply clips/snaps/straps on that side. Unfold cover to the opposite side and repeat.

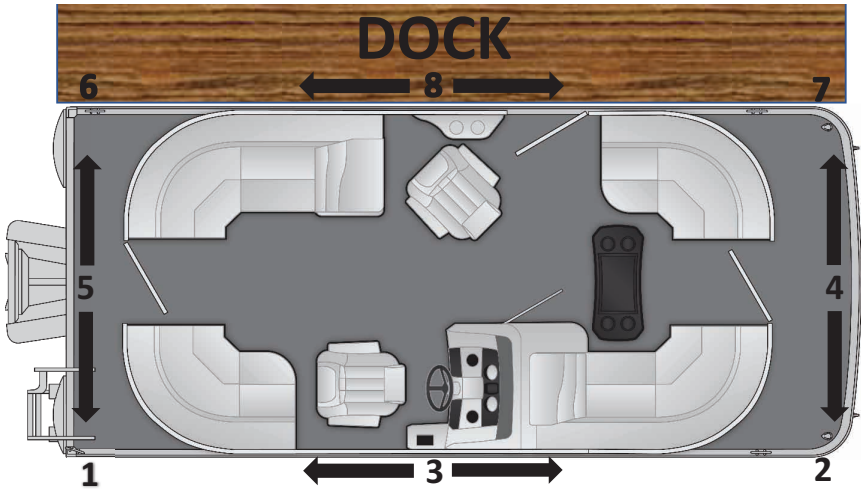

BENN_0013

CARPET

Occasional vacuuming and washing with mild detergent and warm water or household carpet cleaners will keep the carpet clean. Thoroughly wash the detergent out of the carpet with clean water. Let the carpet dry in the sun to prevent any mildew or odor caused by moisture.

To clean mildew off the carpet, first check the cleaner on a small area of carpet that is hidden to determine compatibility of cleaner and carpet. "FISH ATTRACTANTS," which are commonly sprayed on lures and some insect repellants, will cause deterioration of the carpet backing. Spray these formulas away from the boat carpet and clean any spills promptly. **DO NOT** use pressure sprayers to clean boat carpet.

WINDSHIELD

A clean windshield is important. If the boat is equipped with a glass windshield, applying a nonabrasive glass cleaner with a soft cloth will remove most dirt. Clean tinted Plexiglas or plastic windshields with a mild soap solution and damp cloth only. Harsh detergents, solvents, chemicals or dry cloths used on any glass or plastic windshield will scratch the surface.



SECTION
10 **GENERAL CARE AND MAINTENANCE**

WINDOW CHANNELS

Nylon pile is typically used in sliding window channels. Never use any products that contain bleaching solutions to clean window channels or seals. Use only a mild detergent and water solution for cleaning. If windows stick, spray the channels with silicone spray while working the window back and forth.

TEAK

Teak is an organic and porous wood that contains natural oils and silicates that make it ideal for marine applications.

Depending on the interior or exterior application of the teak used on the boat, different cleaning and refinishing procedures may be required. The following information is intended as a guide. Always consult the boat dealer before performing any cleaning or refinishing procedures.

Cleaning

Only use approved teak cleaners and follow the manufacturer's instructions and warnings carefully. The use of unapproved teak cleaners, such as general or all-purpose cleaners, rust removers or cleaners containing acid, will damage the teak and/or fasteners and the caulking used to secure the teak.

When cleaning areas that have caulking in the seams between teak boards, use special care to prevent damaging or removing the caulking. Do not use cleaners containing chlorine.

When cleaning, always scrub across the grain using a Scotch-Brite™ type scrubbing pad or plastic bristle brush. Scrubbing with the grain may cause damage by removing soft grains from the teak. On larger areas, rotary scrubbers can be used.

Refinishing

Lightly sand all teak surfaces periodically to smoothen the exposed surfaces. This exposes less wood grain area to the elements and helps prevent the exposed grains from trapping dirt.

When sanding teak, the grit of the sandpaper and sanding method used depend on the condition of the teak. Minor scratches may be repaired using sandpaper (400 to 1000 grit). Major scratches and refinishing may require a sanding machine and the use of lower grit sandpaper. When sanding, always hold the sandpaper or pad flat on the teak to avoid gouging the teak.



To repair chips, cracks, plugs or breaks, special epoxies are available specifically for use with teak. When replacing caulking, take care to keep the seams dry and clean. Always use caulking approved for teak use and follow the manufacturer's instructions and warnings carefully. Immediately repair damaged areas or areas that always appear wet, as water leaking between seams or under the decking can cause further damage.

Sealants and Oils

The use of sealants or surface finishes on exterior applications is generally not recommended and should only be applied after consulting with the boat dealer. Never use sealants containing kerosene or petroleum products.

As teak is a porous material that contains natural oils and silicates, the use of protective oils or sealants is not recommended for exterior and most interior applications. Applying oil to teak can cause personal safety hazards, permanent teak damage and increased maintenance, and can shorten the life of the teak. In addition, teak oils can be harmful to other materials such as caulk, vinyl, plastics, gelcoats, etc.

BILGE

A boat's bilge area accumulates oil and greasy dirt over a period of time and should be cleaned periodically. Consult the boat dealer for recommendations on special bilge cleaning products and procedures.

BILGE PUMP

Periodically check the bilge pump(s) inlet screens and hoses for obstructions and debris. Foreign materials can clog the screen and hoses or become lodged in the bilge pump impeller, which can cause the pump to malfunction. Periodically check the operation of the bilge pump and float switch, if equipped. Inspect all wiring, clamps and hoses for tightness on a regular basis.

SAFETY EQUIPMENT

Periodically check the safety equipment for damage, general condition and operation when applicable. Always replace safety equipment that is in question or in need of repair:

- Fire extinguisher
- Life jackets
- Visual distress signaling devices
- Audible signaling devices
- Navigational lights
- Emergency radios or Emergency Position Indicating Radio Beacon (EPIRB)
- First aid kit
- Batteries in electronic devices

GENERAL BOATING EQUIPMENT

Periodically check the general equipment on board for damage, general condition and operation when applicable. Always replace equipment that is in question or in need of repair.

- Anchors and anchor lines
- Boat hook
- Dock fenders
- Foul weather gear/clothing
- Mooring lines
- Oars/paddles
- Tool kit
- Tow line



TRAILER

Periodically check the general trailer components for damage, general condition and operation when applicable. Always replace trailer components that are in question or in need of repair.

- Lights
- Electrical connectors
- Tires (condition and pressure)
- Wheel lug nuts and studs
- Wheel valve stems
- Wheel bearings
- License plate and holder
- Rollers, bunks and hardware
- General fasteners (missing, loose or corroded)
- Safety chains or straps
- Winch, winch strap and hooks
- Trailer coupler and latch
- Frame, axle and springs
- Spare tire and wheel
- Brakes and actuator assembly



SECTION
10 **GENERAL CARE AND MAINTENANCE**

This Page Intentionally Left Blank

Section 11

WINTERIZATION AND STORAGE

The boat may be equipped with a variety of specialized systems and components. The following basic and typical information may not apply to your specific application. This section may not cover all systems or components on the boat. Consult the boat dealer for assistance.

Winterizing or storing the boat for extended periods of non-use requires special preparation to prevent boat and system damage. Without proper preparation, if the boat is not used or is stored for extended periods of time, internal parts of the engine may become corroded from lack of lubrication. If the boat is stored in freezing temperatures, water inside the bilge, engine cooling system or boat water systems may freeze and cause damage. Be sure to keep up with all annual maintenance during winterization.

Before performing any winterization and storage procedures within this section, review *Safety in Section 2*.

WINTERIZATION AND STORAGE PREPARATION

The following procedures will help prevent damage to the boat:

- While the boat is still in the water, fill fuel tank(s) with fresh fuel and add the proper amount of fuel stabilizer/conditioner according to the engine manufacturer's recommendations. Operate the boat for at least 15 minutes to be sure that the treated fuel has reached the engine.

NOTICE

If you plan to store the boat for more than three months in either a humid environment, extreme temperatures or outdoors, "fog" the engine with a corrosion-preventing fogging oil according to the propulsion system manufacturer's recommendations. See the Engine Operator's Manual for more information.

- Once the boat is removed from the water, remove the bilge drain plug immediately. Store the drain plug in a plastic bag and tape it to the throttle control lever for easy accessibility the next time you use the boat.
- Inspect all sacrificial corrosion protection anodes for excessive wear and replace as necessary.
- Check all thru-hull fittings and other fasteners for tightness and leakage.
- Thoroughly clean the hull, deck and interior of the boat as soon as you remove it from the water; marine growth is easier to remove when it is wet.
- Always allow all boat compartments to air dry for a couple of days to prevent mildew from trapped moisture. If you use shrink wrap, always allow for ventilation to prevent mildew from trapped moisture.



WINTERIZATION AND STORAGE

- Apply a coat of wax to the entire surface of the boat and rust inhibitor on all metal parts.
- Clean all traces of dirt, oil, grime and grease from the engine and bilge.
- After washing, raise the bow of the boat high to allow as much water as possible to drain while performing other storage preparations.
- Touch up areas where paint has been removed.
- Prepare the engine for storage according to the *Engine Operator's Manual*. Flush the engine cooling system with clean water and/or a nontoxic antifreeze mixture approved for marine use. Never exceed the maximum engine rpm for flushing recommended as stated in the manual.
- Perform all scheduled maintenance for the engine and boat equipment. See the *Engine Operator's Manual* and all equipment manufacturer's information for periodic and annual maintenance procedures.
- Turn off all electrical switches and breakers.
- Remove all batteries from the boat. Clean, fully charge and store the batteries in an area outside the boat not subject to freezing temperatures. Never store batteries close to heat, sparks or open flames.
- Clean all interior upholstery, furniture, appliances, etc.
- To avoid mold and mildew keep floor storage lid and seat storage areas open.
- Pest/rodent repellents may help prevent damage to the boat during storage.

STORING ON A CRADLE OR BLOCKS

- When storing a boat on support other than the proper trailer, make sure the hull is supported properly to prevent hull damage. Most cradles are custom-built to support the boat's hull.
- Put the cradle or blocks on a hard, level surface capable of supporting the combined weight of the cradle and the boat.
- When using blocks with jack stands, always use jack stands that are rated for more than the required load, making sure they are securely positioned so they cannot move under the load. Use a minimum of three blocks to support the keel and each side of the boat where applicable. Use a minimum total of nine jacks and/or blocks.
- Position the boat to allow for adequate draining from rain or snow.



- Cover the boat to prevent the collection of rain, snow or debris. When using a cover, allow ventilation for residual moisture and condensation to escape. Never cover or plug the bilge drain hole.
- Position the lower unit drive in the DOWN position.

STORING ON A TRAILER

- Be sure the trailer supports are adjusted to properly support the boat's hull.
- Repack the trailer wheel bearings with water-resistant wheel bearing grease.
- Park the trailer and boat in a protected area with the lower unit drive in the DOWN position.
- Loosen tie-downs and winch line, but be sure the boat is resting properly on hull supports.
- Lift the trailer and place blocks under the trailer frame to relieve weight on trailer tires and springs. Position the boat to allow for adequate draining from rain or snow.
- Cover the boat to prevent the collection of rain, snow or debris. When using a cover, allow ventilation for residual moisture and condensation to escape. Never cover or plug the bilge drain hole.

RECOMMISSIONING AFTER STORAGE

- Remove blocks from under the trailer frame.
- Tighten tie-downs and the trailer winch line.
- Check tire pressure and lug nut tightness on the trailer.
- Inspect the hull for damage.
- Charge and install all batteries.
- Check the bilge blower vents for obstructions and blower operation.
- Check the bilge pump and float switch for proper operation.
- Inspect all battery and electrical wiring for loose connections and/or damage.
- Check the fuel system for leaks or damage. Verify the condition of all hoses and fuel line. Should a fuel hose need replacing, use only USCG-approved hose. Check hose labels for exact type of replacement. Be sure all hose clamps are tight.
- Check the engine and bilge for signs of nesting animals; clean as necessary.
- Check the entire engine for cracks and leaks caused by freeze damage.
- Check the condition of all hoses and clamps for tightness.



- Clean the bilge area and install the boat bilge drain plug.
- Lubricate all seacocks and check for proper operation.
- Install all drain plugs in strainers and seacocks.
- Close all drains and valves that were opened during winterization.
- Perform any annual maintenance not performed during winterization. See the *Engine Operator's Manual* and all equipment manufacturer's information for periodic and annual maintenance procedures.
- Check the engine's cooling water intake areas and screens for obstructions.
- Check and lubricate the steering system.
- Check all navigational lights.
- Check all controls, gauges, boat systems, accessories and related equipment for proper operation.
- Check all fire extinguishers for charge level.
- Inspect all safety equipment for condition and operation as applicable.
- When possible, briefly start and run the engine(s) using proper water supply equipment to check that the engine does start and there are no major operational problems.

NOTICE

If fogging oil was used during winterization, the engine will emit excessive white smoke upon initial start-up. This condition is normal and will diminish once the fogging oil has been cleared through the engine.

- Once the boat is in the water, start the engine.
- Start the engine(s) and watch the gauge readings closely, checking for leaks and abnormal noises.
- Keep speeds low for the first 15 minutes until the engine has reached normal operating temperature.
- See the *Engine Operator's Manual* and all equipment manufacturer's information for additional recommendations.



LIFTING – 2020 MODEL YEAR

LIFT SYSTEMS: ABYC H40.8

NOTICE

Consult the boat dealer for proper lifting instructions for the boat.

Attempt to lift or hoist boats only if you are qualified or experienced with this procedure. This procedure requires special equipment and experience; do not attempt to lift or hoist the boat alone.



WARNING

Special equipment is necessary to lift the boat and/or engine. Always use lifting equipment with sufficient capacity to lift the boat and/or engine. Failure to follow this warning may result in damage, personal injury or death.

If the boat is to be removed from the water without a trailer, follow these guidelines:

- Cover lifting cables/chains with a rubber hose or other protectors to prevent damage to the boat.
- Attach guidelines to the bow and stern to control movement of boat while lifted.
- Use spreader bars and keep lifting pressure vertical to prevent side load damage.
- Use only the lifting strong point eyes identified below.



STERN

Using a spreader bar, lift with the stainless steel U-bolt eyes. All Bennington boats have a pair of these at the stern near the transom or the outside corners.



BENN_0017

Transom Stainless Steel U-Bolt Eyes



BENN_0018



Outside Stainless Steel U-Bolt Eyes



BENN_0019

Using a spreader bar, lift with the outside tubes' aluminum nosecone eyes.

If the boat is not equipped with these eyes, use the under deck stainless steel U-bolts. **Never use the center tube nosecone for lifting.**



BENN_0020



SECTION

11

WINTERIZATION AND STORAGE

NEVER LIFT WITH THESE

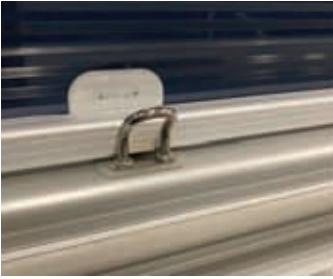

BENN_0008

Mid Ship U-Bolts



BENN_0009

Cleats of Any Style



BENN_0011

Aluminum Stern Tube Eyes



BENN_0022

Center Tube Nosecone Eye

Section 12

TROUBLESHOOTING

The following information will assist you in identifying basic performance, mechanical and electrical problems. This information is intended as a general troubleshooting guide and may describe items that are not applicable to the boat.

The tachometer can be very useful when troubleshooting the boat's performance problems. A typical engine should maintain the same operating rpm throughout the useful life of the boat. When the normal operating rpm is known, that rpm should be used as a starting point when performance problems arise.

If you detect a problem with the engine, see the *Engine Operator's Manual*. If you detect an equipment or boat system problem, see the manufacturer's information for that item.

Before performing any troubleshooting procedures within this section, review *Safety in Section 2*.

NOTICE

Certain problems may require specialized skills and tools. Always consult qualified personnel before making any repairs or modifications.

PROBLEM	POSSIBLE CAUSES
Engine will not crank	<ul style="list-style-type: none"> • Engine emergency stop switch lanyard not connected • Shift/throttle control not in the NEUTRAL position • Main circuit breaker open • Battery switch is in the OFF position • Battery terminals or wiring connections corroded • Low battery voltage • Faulty ignition switch • Engine problem
Engine cranks but will not start	<ul style="list-style-type: none"> • No fuel in tank • Fuel tank valves closed to engine • Fuel filter clogged • Flame arrestor dirty, if equipped • Contaminated fuel • Engine problem



PROBLEM	POSSIBLE CAUSES
Poor boat performance	<ul style="list-style-type: none">• Contaminated fuel• Uneven load distribution• Excessive load• Improper power trim position• Improper trim tab position• Improper propeller selection• Excessive water in bilge• Damaged or obstructed propeller• Marine growth on hull• Damaged hull• Engine system problem• Plugged flame arrestor, if equipped
Throttle/shifting control problems	<ul style="list-style-type: none">• Corroded cable• Excessive bends or kinks in cable• Engine system problem
Excessive vibration	<ul style="list-style-type: none">• Damaged or obstructed propeller• Bent propeller shaft• Engine system problem
Electrical problems	<ul style="list-style-type: none">• Blown fuse/breaker or open circuit• Loose or corroded wiring connections• Defective switch or gauge• Weak or discharged battery• Loose shore power connection
Erratic or no speedometer reading	<ul style="list-style-type: none">• Disconnected, kinked or plugged pickup tube or pitot• Speedometer gauge faulty

Section 13

GLOSSARY OF NAUTICAL TERMS

ABOARD – On or in the boat.

ABYC – American Boat and Yacht Council, Inc.

AFLOAT – On the water.

AFT – Toward the rear or stern of the boat.

AGROUND – Touching bottom.

AMIDSHIP – Center or middle of the boat.

ANCHOR – (1) An iron casting shaped to grip the lake bottom to hold the boat.

(2) The act of setting the anchor.

ASHORE – On the shore.

ASTERN – Toward the stern.

AUTOMATIC CHARGING RELAY (ACR) – An ACR parallels (combines) batteries during charging, and isolates them when charging has stopped and after battery voltage has fallen. An ACR is intended to keep a load from discharging both of the batteries.

AUTOMATIC IDENTIFICATION SYSTEM (AIS) – An automatic tracking system used on ships and by vessel traffic services (VTS) for identifying and locating vessels by electronically exchanging data with other nearby ships, AIS base stations, and satellites.

BAIL – To remove water from the bottom of the boat with a pump, bucket, sponge, etc.

BAITWELL – A miniature livewell used to store and keep live bait alive and healthy.

BEAM – The widest point on the boat.

BEARING – Relative position or direction of an object from the boat.

BILGE – The lowest interior section of the boat hull.

BILGE KEELS – The raised areas or aluminum extrusions on the bottom of a boat that parallel the keel.

BOARDING – To enter the boat.

BOUNDARY WATERS – A body of water between two areas of jurisdiction; i.e., a river between two states.

BOW – The front of the boat.

BULKHEAD – Vertical partition (wall) in a boat.

BUNKS – Carpeted trailer hull supports.

BURDENED BOAT – Term for the boat that must “give-way” to boats with the right-of-way.

CAPACITY PLATE – A plate that provides maximum weight capacity and engine horsepower rating information. It is located in full view of the helm.

CAPSIZING – To turn over.

CAST-OFF – To unfasten mooring lines in preparation for departure.

CENTER LINE – A lengthwise imaginary line which runs fore and aft with the boat's keel.

CHINE – The point on a boat where the side intersects (meets) the bottom.

CLEAT – A deck fitting with ears to which lines are fastened.

CONSOLE – Also called helm. The steering wheel area of the boat.



CONTROLLER AREA NETWORK (CANBUS) – A robust bus standard designed to allow microcontrollers and devices to communicate with each other in applications without a host computer.

CRANKING BATTERY – The main battery used for engine starting and electrical circuits.

CURRENT – Water moving in a horizontal direction.

DECK – The open surface on the boat where the passengers walk.

DEEP-CYCLE BATTERIES – Special long-running batteries which can be repeatedly discharged and recharged without significant loss of power.

DIGITAL SELECTIVE CALLING (DSC) – A standard for sending pre-defined digital messages via the medium frequency (MF), high frequency (HF) and very high frequency (VHF) maritime radio systems. It is a core part of the Global Maritime Distress and Safety System (GMDSS).

DOLLY WHEEL – A rolling jack assembly at the front of the trailer used for positioning the coupler during trailer hookup.

DRAFT – The depth of the boat below the waterline, measured vertically to the lowest part of the hull.

ELECTRONIC LEAKAGE CIRCUIT INTERRUPTER (ELCI) – Installed with or in addition to the main shore power disconnect circuit breaker(s) to offer an additional level of protection from shore power faults.

ELECTRONIC NAUTICAL CHARTS (ENCs) – Vector data sets that support all types of marine navigation.

ELECTROLYSIS – The breakup of metals due to the effects of galvanic corrosion.

EMERGENCY POSITION INDICATING RADIO BEACONS (EPIRBs) – Safety devices carried by a vessel to alert search and rescue services and allow them to quickly locate you in the event of an emergency.

FATHOM – Unit of depth or measure; 1 fathom equals 6 feet.

FENDERS – Objects placed alongside the boat for cushioning. Sometimes called bumpers.

FORE – Toward the front or bow of the boat. Opposite of aft.

FREEBOARD – The distance from the water to the gunwale.

FUEL SENDING UNIT – The electrical device that is mounted on the outside of a built-in fuel tank and controls the dashboard fuel gauge.

GIVE-WAY BOAT – (1) Term for the boat that must take whatever action necessary to keep well clear of the boat with the right-of-way in meeting or crossing situations. (2) The burdened boat.

GLOBAL MARITIME DISTRESS AND SAFETY SYSTEM (GMDSS) – An internationally agreed-upon set of safety procedures, types of equipment, and communication protocols used to increase safety and make it easier to rescue distressed ships, boats and aircraft.

GLOBAL POSITIONING SYSTEM (GPS) – A global navigation satellite system that provides geolocation and time information to a GPS receiver.

GROUND FAULT CIRCUIT INTERRUPTER (GFCI) – A type of circuit breaker that measures current flow in the hot and neutral wires and immediately switches the electricity off if an imbalance of current flow is detected.



GUNWALE – The rail or upper edge of a boat's side.

HEAD – A marine toilet.

HELM – The steering wheel or command area.

HULL – The body of the boat.

HYPOTHERMIA – A physical condition where the body loses heat faster than it can produce it.

IN-LINE FUSE – A type of protective fuse located in the power wire of a direct current (DC) circuit usually near the battery.

KEEL – The lowest portion of the boat; extends fore and aft along the boat's bottom.

LIFE JACKET – A buoyant, wearable jacket that, when properly used, will support a person in the water; also see PFD.

LIST – Leaning or tilt of a boat toward the side.

MAKING WAY – Making progress through the water.

MARINE CHART – Seagoing maps showing depths, buoys, navigation aids, etc.

MOORING – An anchor, chain or similar device that holds a boat in one location.

NATIONAL MARINE ELECTRONICS ASSOCIATION (NMEA) – A U.S.-based marine electronics trade organization setting standards of communication between marine electronics.

NATIONAL OCEANIC AND ATMOSPHERIC ADMINISTRATION (NOAA) – An American scientific agency within the United States Department of Commerce that focuses on the conditions of the oceans, major waterways and the atmosphere.

NAVIGATION AID – Recognizable objects on land or sea such as buoys, towers or lights which are used to fix position to identify safe and unsafe waters.

NMMA – National Marine Manufacturers Association.

NO-WAKE SPEED – The speed at which a boat travels to produce an imperceptible wake.

PASSIVE HYDROLOCK – A problem that occurs when water siphons through the boat's exhaust system, enters a cylinder in the engine and results in an engine starting failure. This problem is possible on any marine vessel powered by a combustible engine with exhaust risers that sit below the waterline.

PFD – A buoyant personal flotation device used to support a person in the water; also see Life Jacket.

PITOT TUBE – See Speedometer Pickup Tube.

PLANING HULL – A hull designed to lift, thereby reducing friction and increasing efficiency.

PORPOISE – A condition in which the bow bounces up and down caused by trimming the engine too far out.

PORT – (1) The left side of a boat when facing the bow. (2) A destination or harbor.

PRIVILEGED BOAT – Term used for the boat with the right-of-way.

RIGHT-OF-WAY – Term for the boat that has priority in meeting or crossing situations. The stand-on or privileged boat.

RULES OF THE ROAD – Regulations for preventing collisions on the water.

SPEEDOMETER PICKUP TUBE – Also called pitot tube. The plastic device that extends below the bottom of the boat. It connects to the speedometer with plastic flexible tubing.



SPLASHWELL – The section of an outboard-equipped boat that is just forward of the transom.

STAND ON BOAT – Term for the boat that must maintain course and speed in meeting or crossing situations. The privileged boat.

STARBOARD – The right side of the boat when looking toward the bow.

STERN – The back of the boat.

STOW – To pack the cargo.

STRONG POINT– A dedicated eye specially reinforced for the attachment of mooring lines, anchor chains, anchor lines and tow lines.

SURGE BRAKES – A type of trailer braking system designed to automatically actuate when the tow vehicle's brakes are applied.

TRANSDUCER – The unit that sends/receives signals for the depth sounder.

TRANSOM – The transverse beam across the stern.

TRIM – Fore to aft and side to side balance of the boat when loaded.

UNDERWAY – Boat in motion; i.e., not moored or anchored.

USCG – United States Coast Guard.

WAKE – The waves that a boat leaves behind when moving through the water.

WATERWAY – A navigable body of water.

V-PAD – A modified vee-hull design with a small, flat area in the keel aft.

VISUAL DISTRESS SIGNAL – A device used to signal the need for assistance such as flags, lights and flares.

INDEX

Numerics

5-pin wiring connector 8-5

A

Accelerating and running
underway 7-14
Accidents 3-2, 4-7
Alcohol 3-3
Aluminum 10-23
American Boat & Yacht Council 1-5
American Red Cross 1-5
Anchor 7-21
Anchor line 7-21
Anchors and anchoring 7-21
Anodes 10-18, 11-1
Antifouling bottom paint 10-23
Aquatic Invasive Species (AIS) 3-9
Aquatic vegetation/weeds 5-3
Audible (sound) signals 2-23, 6-4
Audible alarms 9-12
Audible signaling
devices 2-15, 2-23

B

Backing up 8-9
Basic safety rules 2-1
Battery 9-6, 9-14
Battery isolators 9-6
Battery switches 9-14
Bell 6-4
Bilge 10-31
Bilge pump 10-31
Bilge pump system 9-16
Blower switch 9-13
Boarding 7-3
Boarding switches 9-16
Boat loading 7-3
Boat Owners Association of
The United States 1-5
Boat system failure 4-6
Boating accident 3-2
Boating regulations 3-1, 6-1
Boating under the influence 3-3
BoatU.S. Foundation for
Boating Safety Hotline 1-6

Buffing 10-24
Buoys 6-8, 6-11, 6-12, 6-13, 6-14

C

Capacity plate 7-3
Capsizing and flooding 4-5
Carbon monoxide poisoning 2-31
Carpet 10-29
Charging system 9-6
Circuit breakers 10-16
Cleaners 10-24, 10-25
Cleaning 10-24
Cleaning agents 3-10
Cold water 5-2
Cold weather and cold or
frozen water conditions 5-2
Collision 4-7
Communication equipment 4-1
Compass 9-12
Compliance plate 1-3
Courtesy switches 9-16
CPR 4-1
Crossing 6-7
Cruising limitation 2-30

D

Dams 5-3
Dams and spillways 5-3
Danger signal 6-4
Daymarks 6-12
Daymarks/Dayboards 6-9
DC system 9-6
Debris 5-3
Diameter 9-7
Distress signaling devices 4-1
Distress signals 6-4
Docking 7-19
Drain plug 11-1
Drugs 3-3
Dual-prop drives 9-8

E

Electric supply 9-6
Electrical system 9-6
Electrolysis 10-17



Emergencies4-1, 4-7
Emergency assistance 3-4
Emergency checklist 4-1
Emissions 3-11
Engine cooling system9-2, 11-2
Engine hour meter 9-12
Engine lubrication system 9-1
Engine warning alarm system 9-12
Engine water temperature
gauge 9-11
Exhaust emissions 3-11

F

Fasteners 10-22
Fire and explosion 4-3
Fire extinguishers2-16, 2-17
Fires 2-17
First aid/medical emergencies 4-1
Fishing 3-6
Flags 5-4
Float plan 7-1
Float switch 10-31
Fog conditions 5-2
Fogging oil 11-1
Freezing temperatures 11-1
Fuel (gasoline) 7-5, 7-6, 10-2
Fuel filler 7-8
Fuel level gauge 9-10
Fuel management 7-5
Fuel stabilizer 11-1
Fuel suppliers 7-5
Fuel system9-1, 10-2
 Fuel filter 10-2
 Fuel tanks 9-1
Fueling 7-5, 7-6, 7-8
Fuses 10-15

G

Galvanic corrosion10-17, 10-23
 Anodes 10-17
Gauges 9-9
Gauges/Instruments 9-9
Gelcoat 10-24
General boating equipment 10-32
Glossary of nautical terms 13-1

Gross Vehicle Weight Rating
(GVWR)8-2

H

Hazard information2-30
Hazard labels2-4
Hazards 5-2, 5-4
Helm 7-11, 9-3
Helm and control switches9-13
Hitch ball and trailer coupler8-3
Horn6-4
Horn switch9-16
Hull identification number1-2
Hypothermia 4-1, 5-2

I

Icy waters5-2
Ignition switch9-13
Inclement weather5-2
Insurance3-2

L

Lateral markers6-12
Launching8-9
Law of salvage4-3
LED lighting2-24
Life jackets2-15
Lighthouses6-11
Lights9-16
Lights and lighted structures6-10
Lights switch9-16
Lines and knots7-23
Loading8-11
Loading guidelines8-11

M

Maintenance10-1
Man Overboard (MOB)4-4
Manatee6-13
Marine Assistance Request
Broadcast (MARB)4-2
Marine growth10-23
Markers 6-8, 6-13
Markers, warnings and
advisories5-4
MARPOL treaty3-9



Mayday	4-2
Medical emergencies	4-1
Meeting head-on	6-6
Mildew	10-25
Minimum on-board personal safety equipment	2-15
Minor lights	6-12
Minors	3-3
Monofilament fishing line	3-7
Mooring	7-21
Mooring buoys	6-9
Multi-gauges	9-9

N

National Association of State Boating Law Administrators	1-6
National Marine Manufacturers Association	1-6
National Oceanic and Atmospheric Administration's National Weather Service	1-6
National Safe Boating Council Inc.	1-6
Nautical terminology	1-2
Navigation lights switch	9-16
Navigation markers	5-4
Navigational lights	2-23, 2-24
Navigational lights and night operation	6-2
Navigational rules	6-1
Negligent operation	3-4
Neutral start safety switch	9-16
Noise	3-7

O

Observer	2-33
Oil level	9-12
Oil level gauge	9-12
Operating under the influence	3-3
Operation by minors	3-3
Organizations	1-5
Outboard engine fueling considerations	7-9
Overboard dumping	3-9
Overtaking/passing	6-5

P

Paints	3-10
Passengers	7-10
Performance	7-3
Performance operation	7-19
Pitch	9-7
Planing	7-14
Platform dragging	2-31
Power trim and tilt	7-16
Power trim operation	7-16
Pre-departure safety checklist	7-2
Propeller	9-7, 9-8
Proposition 65	3-11
Protecting the boat from theft	4-9
Protecting the environment	3-8
Publications	1-5

R

Range lights	6-10
Range markers	6-12
Reduced visibility	5-2
Registration	3-2
Registration certificates	3-2
Registration numbers	3-2
Regulations	3-3, 3-7, 3-10
Regulatory markers	6-11
Reporting accidents	4-7
Reporting safety defects	8-12
Requesting assistance (non-distress call)	4-2
Restricted areas	3-5
Right-of-way	6-1
Rotational thrust	7-12

S

Safe water markers	6-13
Safety	7-3
Safety chains	8-4
Safety decals	2-4
Safety equipment	7-1, 10-32
Safety guidelines	2-2
Safety standards	1-3
Saltwater corrosion	10-17
Sea Tow Services International, Inc.	1-6



Seals in the engine lower unit 3-6
Security zones 3-5
Severe weather 5-1
Shallow water 5-3
Shallow water operation 5-3
Shift and throttle controls 9-4
Shifting 7-13, 9-5
Shock 5-2
Signs 6-13
Single-lever controls 9-4
Special markers 6-12
Speed 3-7
Speed limits 3-7
Speedometer 9-10
Spillways 5-3
Spotter 2-33
Starting 7-10
Static electricity and the fuel
system 7-5
Steering 7-11
Steering system 9-2
Stopping 7-12
Storing 11-1
Storm conditions 5-1
Storm warning 5-4
Surge brakes 8-5
Switches 9-13

T

Tachometer 9-9
Teak 10-30
The general prudential rule 6-1
Throttle controls 9-4
Thru-hull fittings 11-1
Towing hitch 8-2
Towing on the water 4-7
Towing vehicle 8-2
Trailer 8-1, 10-33
Trailer brakes 8-5
Trailer classification 8-1
Trailer regulations 8-1
Trailer type 8-1
Trailerling guidelines 8-6
Type B fire extinguishers 2-17

U

U.S. Coast Guard (USCG) 1-6, 3-1
U.S. Coast Guard Auxiliary 1-6
U.S. Coast Guard Navigation
Center (NAVCEN) 1-6
U.S. Coast Guard Office of
Boating Safety 1-7
U.S. Coast Guard's America's
Waterway Watch Program 1-7
U.S. Government Printing Office ... 1-7
U.S. Power Squadrons 1-7
United States Aids to Navigation
System (USATONS) 6-8
Upholstery 10-25
USCG safety standards 1-3

V

Vegetation 5-3
Vinyl cleaner 10-25
Visibility 5-2
Visual distress signaling
devices 2-15
Visual distress signals (VDS) 2-22
Voltmeter 9-11

W

Wake 3-7
Washing 10-24, 10-25
Water depth gauge 9-12
Water hazards 5-2
Water sports 2-31
Water sports guidelines 2-32
Weather 4-6
Whistle 6-4
Window channels 10-30
Windshield 10-29
Winterization and storage
 Winterizing 11-1

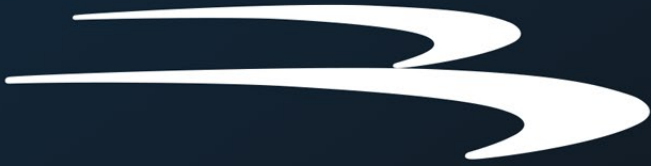

Bennington

2805 Decio Drive

Elkhart, IN 46514

BenningtonMarine.com

Printed in the U.S.A. Part No. 019497

Scan For
More Owner
Resources

