

Universal Class

SUPER 1803-3i

WHEELED PAVER



Maximum pave width 8m
Maximum laydown rate 700 tonnes/h
Transport width 2.55m

PREMIUM LINE

 www.voegele.info



Powerful wheeled paver



The **SUPER 1803-3i** combines at a high level of perfection features such as sturdy and reliable material handling, large pave widths up to 8m and extremely high mobility.

When developing this road paver, a special focus was on ergonomic, economic and ecological aspects. The VÖGELE EcoPlus package, for instance, significantly reduces both fuel consumption and noise levels. The VÖGELE ErgoPlus 3 operating system has been supplemented by numerous ergonomic and functional features for the "Dash 3" generation.

The paver operator's console, for example, comes with a large colour display which provides brilliant readability even in poor lighting conditions. In addition, the convenience functions AutoSet Plus and PaveDock Assistant make work with the SUPER 1803-3i even easier.

Being one of the most powerful wheeled pavers of the Universal Class, the SUPER 1803-3i handles a wide range of applications from narrow pave widths through to motorway.

The highlights of the SUPER 1803-3i



Wheeled Universal Class paver with a large range of applications and pave widths up to 8m

Powerful and economical drive concept with VÖGELE EcoPlus, the low-emissions package from VÖGELE

Optimum feeding with mix thanks to the large material hopper and PaveDock Assistant communication system

Significantly smaller turning radius due to Pivot Steer steering brake

Easy operation with the ErgoPlus 3 operating system with numerous convenient and automatic functions

Screeds to meet all needs: The wheeled paver can be combined with the AB 500 and AB 600 Extending Screeds

The drive concept – Efficiency, performance and low consumption



The modern drive concept from VÖGELE guarantees full power whenever it is needed and superior technology makes this Universal Class paver exceedingly economical in everyday use.

This is assured by intelligent motor management with ECO mode and the low-emissions package VÖGELE EcoPlus. Fuel consumption and noise levels of the SUPER 1803-3i have been significantly reduced.

With its high tractive power, the wheeled SUPER 1803-3i perfectly combines high paving performance with maximum mobility when travelling.

Full power – Intelligent technology

Three main components define the power unit of a SUPER 1803-3i: its modern, liquid-cooled diesel engine, a splitter gearbox flanged directly to the engine and a large cooler assembly.

The driving force in this power pack from VÖGELE is its diesel engine. The six-cylinder engine delivers 125kW at 2,000rpm. Yet the fuel-saving ECO mode is sufficient for many applications. And even then, the SUPER 1803-3i still has a full 121kW at its disposal. Moreover, the machine generates even less noise when running at just 1,700rpm.

A large cooler assembly ensures that the power unit always delivers its full output. With innovative air routing and a variable-speed fan, temperatures

are continually maintained within the optimum range, significantly extending the service life of both the diesel engine and the hydraulic oil. A further advantage is that the machine can operate without difficulty in all climate regions worldwide.

All hydraulic consumers are directly supplied with hydraulic oil via the splitter gearbox. Hydraulic pumps and valves are centrally located, making them optimally accessible for servicing. Even the powerful generator for screed heating is flanged directly onto the splitter gearbox; its integrated oil cooling system makes it completely maintenance-free and very quiet.



The power unit of the SUPER 1803-3i with diesel oxidation catalyst (DOC) and selective catalytic reduction (SCR) for exhaust gas after-treatment complies with the strict requirements of European exhaust emissions standard Stage 4 and US EPA standard Tier 4f.

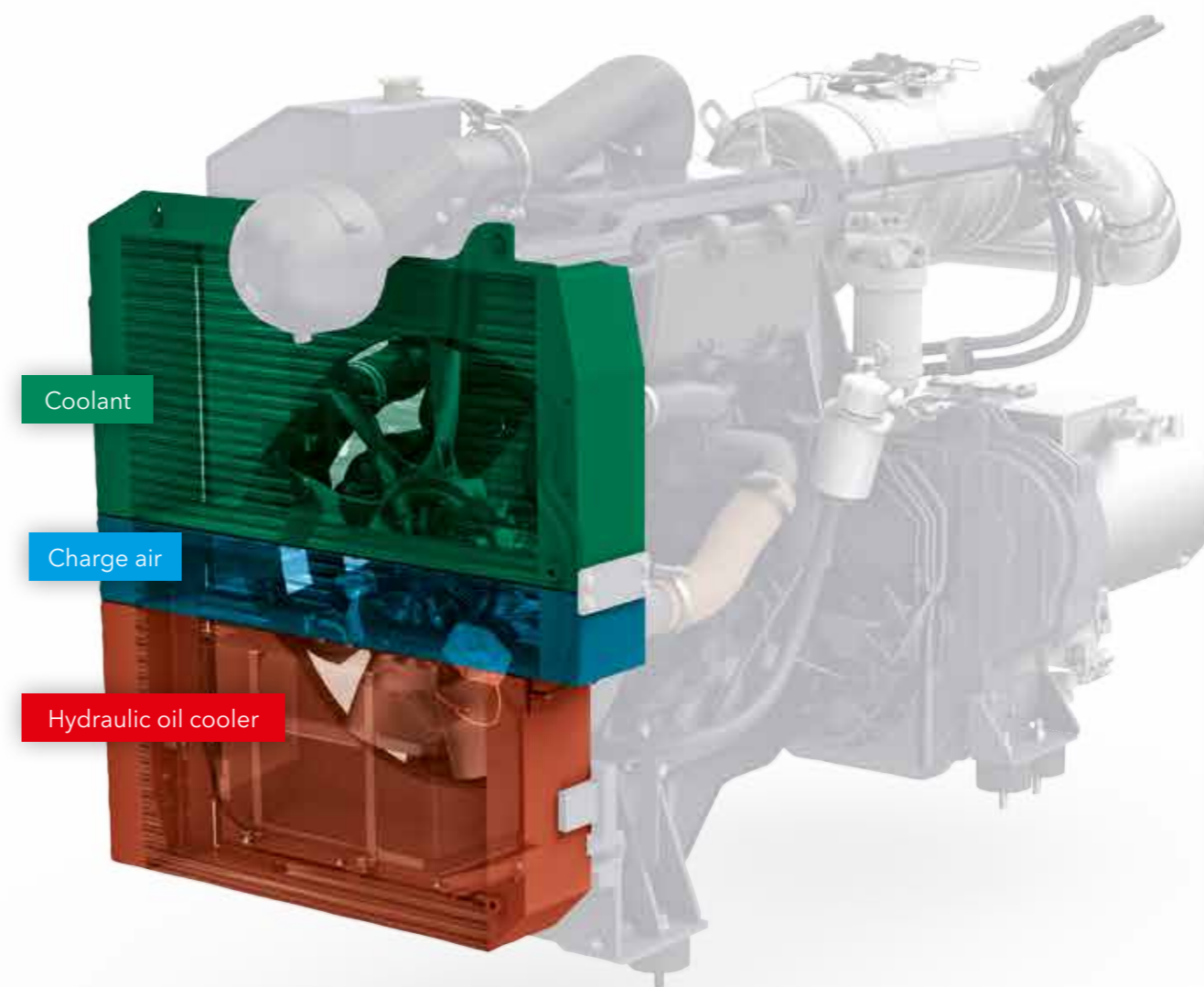

The large cooler assembly is made up of three parts. It ensures that engine coolant, charge air and hydraulic oil are maintained at the optimum temperature.

» **Machines with the suffix "i"** in their product designation are not only economical, but also extremely clean.

The "i" stands for "intelligent emission control" and is found in the type names of all machines from the WIRTGEN GROUP equipped with the latest engine technology. These engines comply with the strict requirements of the current exhaust emissions legislation.

» **Powerful diesel engine** rated at 125kW.

» **ECO mode with 121kW** cuts operating costs and allows super-quiet operation.

» **A powerful, oil-cooled generator** with direct drive ensures rapid, uniform heating of the screed.

VÖGELE EcoPlus: Less is more

It goes without saying that our road pavers conform to the applicable emissions directives, but we like to go much further. That's why the machine concept of the "Dash 3" generation uses environmentally friendly innovations in machine technology, resulting in lower consumption, lower emissions and lower costs.

One of these innovations is the VÖGELE EcoPlus low-emissions package. Fuel savings of up to 25% can be achieved with VÖGELE EcoPlus, depending on the application and capacity utilization of the paver.

That doesn't just result in considerable savings for the contractor - it is good news for the environment, too. That's because every litre of fuel saved reduces carbon dioxide (CO₂) emissions.



25% FUEL SAVING



25% LESS CO₂ EMITTED



LOWER NOISE EMISSIONS

The technical innovations

01



Splitter gearbox with ability to disengage hydraulic pumps

When the paver is stationary, all the hydraulic pumps needed for "traction", "conveyors and augers" and "compaction" are disengaged automatically. The result? Lower fuel consumption.



02

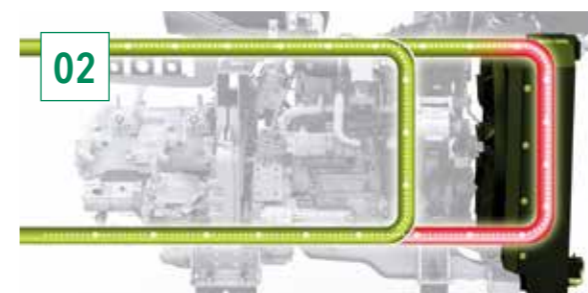

Controlled hydraulic oil temperature circuit

A bypass circuit gets the hydraulic oil to its optimum operating temperature very quickly, enabling rapid, fuel-saving operation of the paver.



03

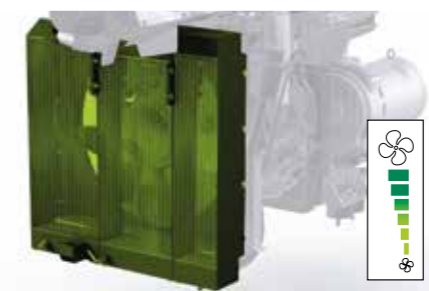

Variable-speed fan

The variable-speed fan automatically adapts to the engine load and the ambient temperature. This type of drive saves energy and reduces noise emissions.



Mobility on wheels

With its high tractive power, the wheeled paver SUPER 1803-3i perfectly combines high paving performance with maximum mobility when travelling. This is assured by powerful separate hydraulic drives directly integrated into the powered wheels. They ensure maximum traction when paving and travelling on public roads at speeds of up to 20km/h. The paver operator can activate Pivot Steer whenever maximum manoeuvrability is required.



- » **Rapid transport under its own power** at up to 20km/h – a feat the SUPER 1803-3i is optimally equipped for. All paving functions are automatically deactivated when "Road Travel" mode is selected. In addition, the paver is equipped with the approved lighting for public traffic. As a result, this paver – like all other wheeled pavers from VÖGELE – meets the basic requirement for driving on public roads.
- » **Maximum power transmission** thanks to separate, hydraulic drives provided for the rear wheels and one set of front wheels (all-wheel drive as an option).

- » **Optimum traction** is assured, even on difficult terrain, by electronic traction management and an electronic differential lock acting on the drives of the rear wheels.
- » **Continuous ground contact** is assured by a front axle which oscillates both lengthwise and crosswise. In other words, the front axle is only firmly connected to the chassis at one point; in combination with the rigidly suspended rear wheels, this creates a static 3-point support.

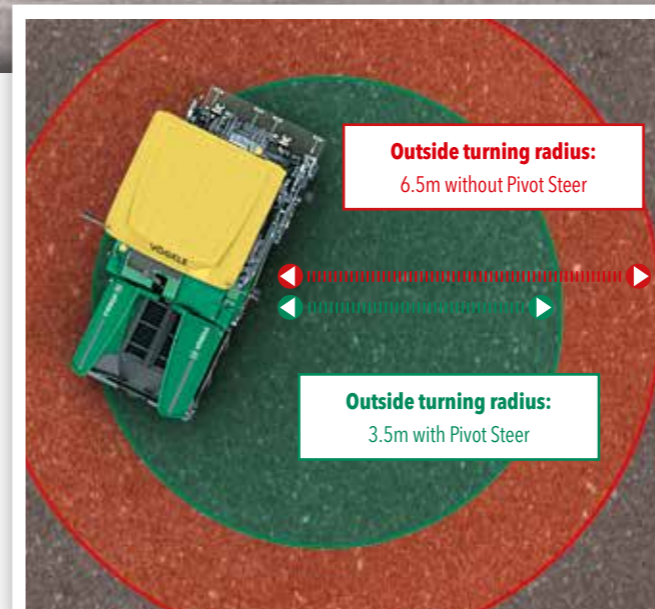

Extreme manoeuvrability thanks to Pivot Steer: The rear inside wheel is automatically slowed down hydraulically when Pivot Steer is activated. This minimizes the outside turning radius to not more than 3.5m for positioning manoeuvres and paving.

Perfect paving quality thanks to perfect material management



A continuous flow of mix is key to ensuring uninterrupted and high-quality paving. That is why we attach such importance to professional material management when designing our pavers.

All our development efforts focus on simple operation and the best possible overview for the paving team.

PaveDock Assistant from VÖGELE is an innovative solution standardizing and simplifying communication between the paver operator and driver of the feed vehicle.

Large material hopper, easy feed with mix

As with all VÖGELE pavers, supplying the SUPER 1803-3i with mix is a clean, safe and swift process.

Thanks to a hydraulically operated hopper front (option), the mix inside the material hopper is directed right onto the conveyors and the entire mix properly conveyed in front of the screed.



- » **The large material hopper** holding 13t is amply dimensioned so that a sufficient quantity of mix is stored at all times. There is no problem tiding over difficult situations such as paving under bridges, for instance.
- » **Easy feeding with mix** thanks to low material hopper, wide hopper sides and sturdy rubber baffles fitted to the hopper front.
- » **Especially large oscillating push-rollers** for convenient and shock-free docking of feed vehicles even on bends.

Perfect conveying and spreading of mix – The basis for perfect pavement quality

Thanks to the perfect spreading of mix, the SUPER 1803-3i provides for an optimal head of material in front of the screed in every paving situation.

Powerful, separate hydraulic drives for conveyors and augers are installed achieving high laydown rates up to 700t/h.

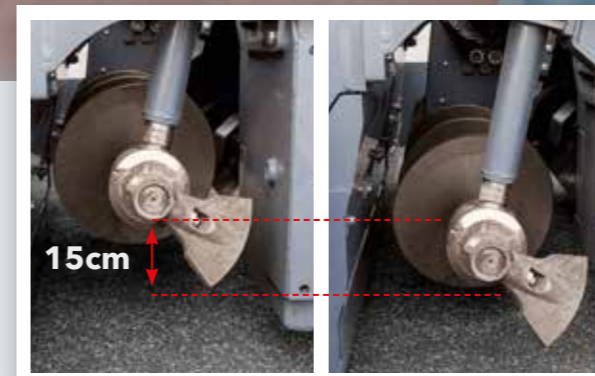

The height of the auger complete with bearing boxes and limiting plates for the auger tunnel can be hydraulically adjusted by up to 15cm across the full pave width. This optimizes the head of mix in front of the screed, even when paving thin layers or when layer thickness varies.

- » **Proportional control and continuous monitoring** provided for conveyors and augers guarantee a constant head of mix front of the screed in line with requirements.
- » **Large diameter of auger blades** (400mm) for excellent spreading of mix when paving in large widths.
- » **An auger tunnel**, easily variable in depth, provides for an optimal flow of mix when large quantities are being laid.

PaveDock Assistant: The communication system

A constant feed of material is a fundamental prerequisite for high-quality paving and perfect evenness.

PaveDock Assistant is the communication system between the paver operator and the driver of the feed vehicle. It allows particularly fast and reliable transfer of mix to the paver.

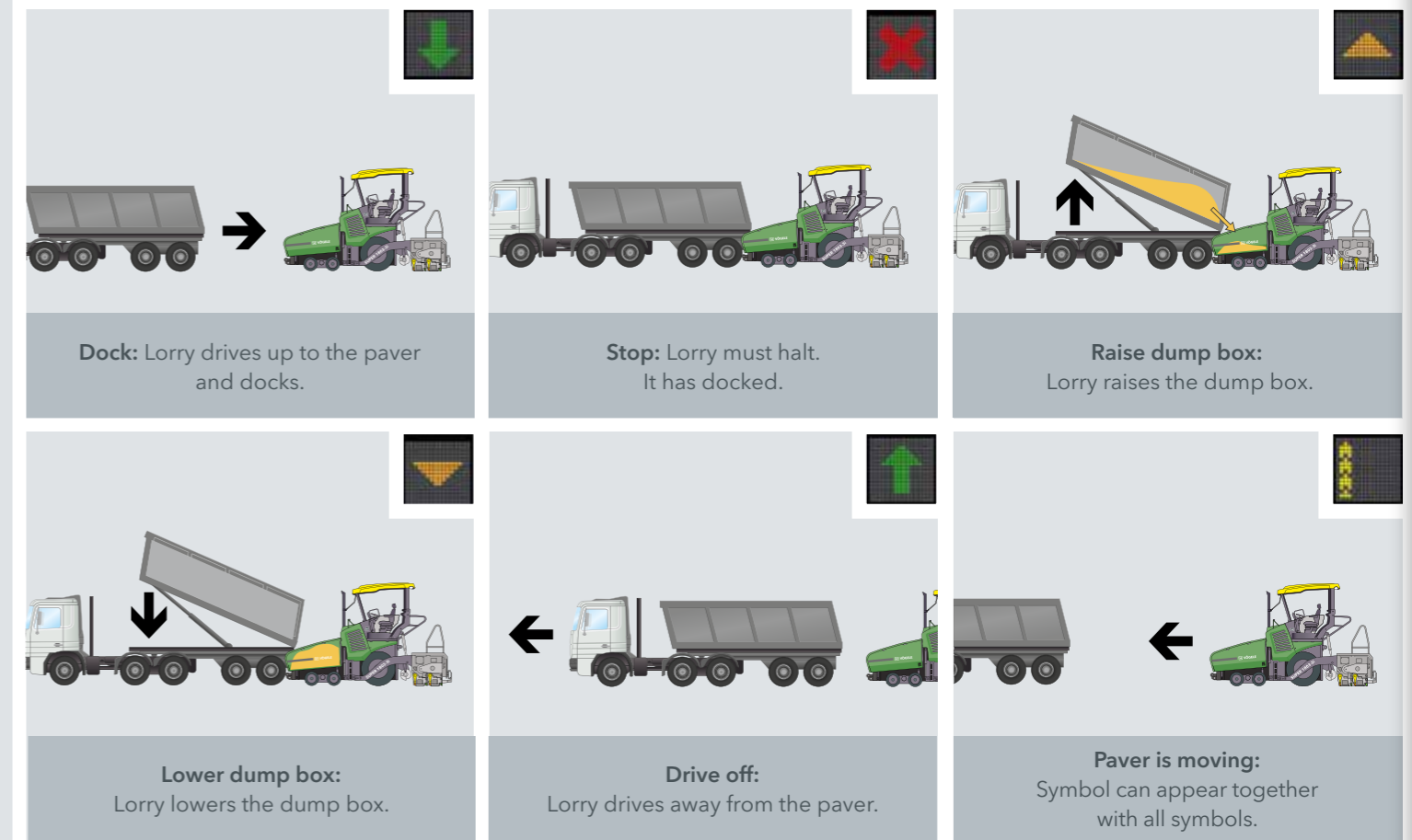

The core element of the PaveDock Assistant are the signal lights on the paver and the associated control elements on the paver operator's ErgoPlus 3 console.

The paver has two sets of signal lights, mounted on the right and left of the hardtop. With these lights, the paver operator can give the driver of the feed vehicle unmistakable signals, indicating what needs to be done (e.g. reverse, stop, dump mix). Having two lights, each in an elevated position, ensures that all signals are clearly visible to the feed vehicle driver from all angles of approach.

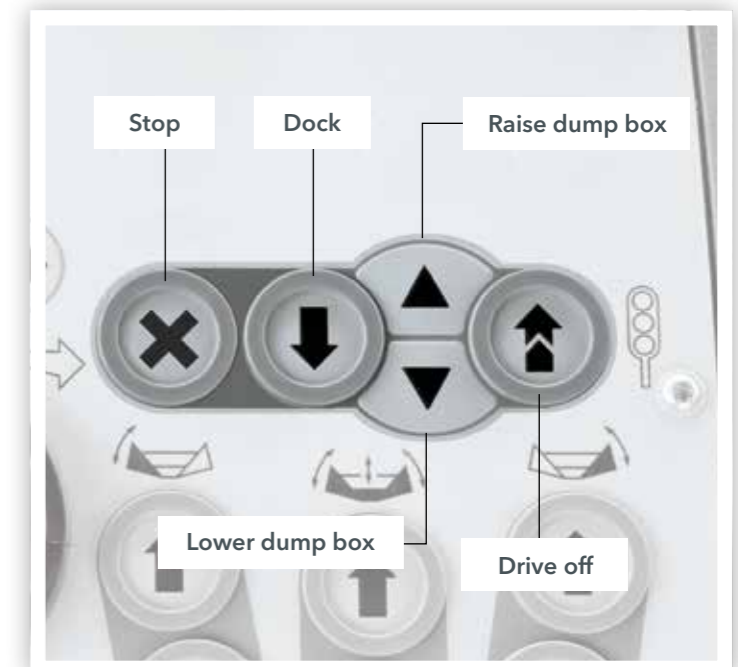

Automated Processes with AutoSet Plus

With **AutoSet Plus**, we have enhanced the efficiency, convenience and quality of key job site processes. AutoSet Plus has two handy automatic functions.

The Repositioning and Transport function greatly facilitates the continuation of work when moving the paver on the job site from one work section to another, or after the paver has been transported.

Simply pressing the "Execute" button quickly and reliably readies the machine for travel on the job site, or for transport. Pressing the button again returns it to the previously stored working position.

The Paving Programs function allows the operating personnel to save the configured machine parameters and store these as a paving program in the menu. This program can then be called up and used whenever needed.

The two comfort functions of AutoSet Plus automate routine tasks, allowing work processes to be carried out more quickly and with greater control. This in turn means that construction projects can be completed faster and more reliably.



1 // AutoSet Plus – Repositioning function

Fast and safe repositioning of the paver on the job site.

No settings are lost between paving and repositioning.

Also prevents any damage to the augers.

2 // AutoSet Plus – Paving Programs function

Automated configuration of the paver.

Stores all paving-relevant parameters.

Selection of stored paving programs.

Reproducible quality.



AutoSet Plus Repositioning function

AutoSet Plus is especially helpful when the machine frequently has to be moved on the job site.

Simply pressing the "Execute" button raises the augers and the hydraulically operated hopper front to the uppermost positions. The screed and the screed tow point rams are brought into transport position. In addition, the screed is locked hydraulically in transport position. The conveyors are temporarily reversed, preventing mix falling to the ground when the paver travels to the next work section on site.

Once the paver has been repositioned, pressing the "Execute" button again returns all systems to the previously stored working positions.

This ensures that no settings are lost when changing from paving to repositioning or transport. It also effectively prevents any damage to the machine.

1. The AutoSet Plus Repositioning function

is activated just by pushing the "Execute" button.

2. Raise/lower screed.

3. Lock/unlock screed.

4. Screed tow point rams in transport position/at last set value.

5. Raise/lower augers.

6. Conveyor movement reversible for a short time.

7. Raise hopper front.

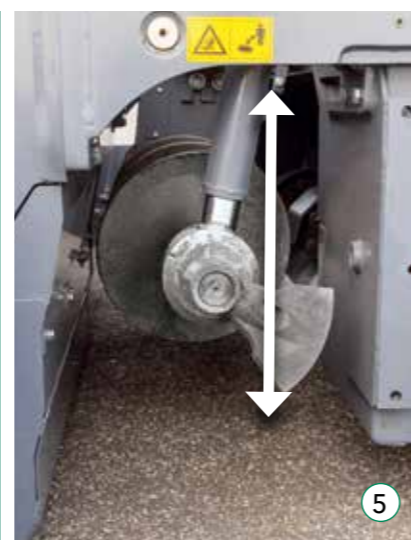

AutoSet Plus Paving Programs



The automatic Paving Programs function allows the operating personnel to store their own paving programs. All key parameters for paving a specific layer (example: base course of asphaltic concrete, 18cm thick) can thus be saved.

On the display of his console, the paver operator saves the values set for the compacting systems (tamper and vibrator speed, pressure for the pressure bars), height of the augers, position of the tow point rams, pressure for Screed Assist and the pave speed in his program.

He also enters the amount of crown and the screed temperature. The program is completed with additional information on the material being used, the layer thickness and the pave width.

The stored paving programs can subsequently be selected and used at any time via the menu. In the event of a repeat situation, this ensures that work is carried out with exactly the same settings while maintaining a consistent quality.

The ErgoPlus 3 operating concept

Even the very best machine with the most advanced technology can only really show its strengths if it can be operated easily and as intuitively as possible. At the same time, it should offer an ergonomic and safe working environment for the operating team. Therefore, the ErgoPlus 3 operating concept focuses on the operator. With VÖGELE pavers, the user consequently retains full control over the machine and construction project.

On the following pages example illustrations will provide you with more detailed information on the extensive functions of the ErgoPlus 3 operating concept. ErgoPlus 3 encompasses the operator's stand, the paver operator's console and screed consoles and Niveltronic Plus, the System for Automated Grade and Slope Control.



The paver operator's
ErgoPlus 3 console

"Full control for the machine operator!"

The paver operator's ErgoPlus 3 console

The paver operator's console is extremely clear and has been designed according to practical principles. All functions are combined into logical groups, so that the operator finds each function exactly where he would expect it to be. On the ErgoPlus 3 console, all push-buttons are easily identifiable by touch even when wearing work gloves.

Once a button is pressed, off you go thanks to the "Touch and Work" principle. This means that a function is executed directly – without a need to confirm.



- **Module 1:** Conveyors and augers, traction
- **Module 2:** Screed
- **Module 3:** Material hopper and steering
- **Module 4:** Display for monitoring and adjustment of basic settings

Lighting for travelling on public roads

As a standard feature, all wheeled pavers from VÖGELE are equipped with a lighting system approved throughout Europe for travelling on public roads. The push-buttons for indicating direction, warning lights, dipped lights and full beam are clearly arranged side by side on the paver operator's console.



Pivot Steer

The Pivot Steer steering brake can be switched on with a simple push of a button in the "Positioning" and "Pave" modes. When it is activated, the speed of the rear inside wheel is automatically slowed down hydraulically when a steering movement is carried out. This reduces the turning radius to a minimum.

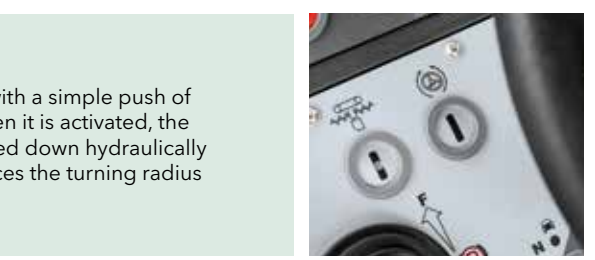

AutoSet Plus Repositioning function (option)

With the AutoSet Plus Repositioning function, the paver is quickly and safely prepared for a move on the job site at the push of a button. After the move, all paver components are reset to their previous working positions, simply by pressing the button again. This ensures that no settings are lost when changing between "Pave" and "Job Site" modes. AutoSet Plus also effectively prevents damage during transport.

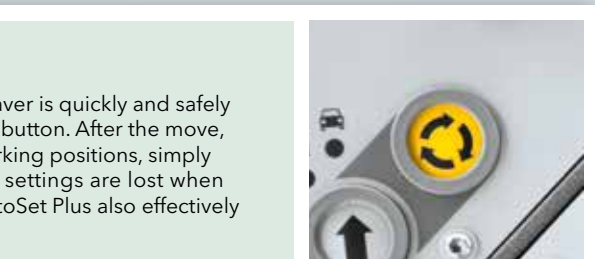

Choice of operating modes for the paver

All the main paving and machine functions can be controlled directly by individual push-buttons on the paver operator's ErgoPlus 3 console. By pressing the arrow buttons, up or down, the operator changes modes in the following order: "Road Travel", "Neutral", "Job Site", "Positioning" and "Pave". An LED indicates the mode selected.

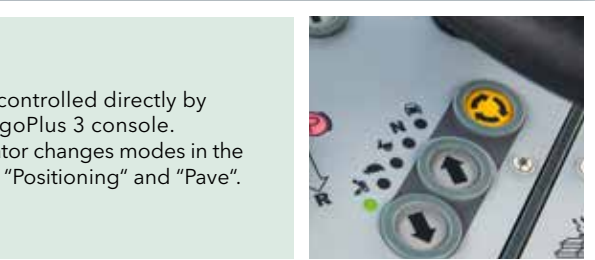

Safe operation during the night

Glarefree backlighting comes on automatically as darkness sets in so that the paver operator can also work safely on night-time jobs.

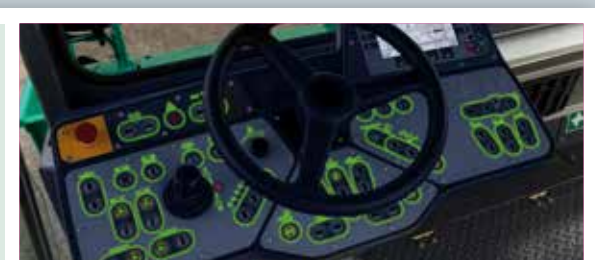

Display of the paver operator's console

The high-contrast colour display provides for brilliant readability even in poor lighting conditions. Vital information is shown on menu level 1, such as the positions of the screed tow point rams or the material level in the conveyor tunnel. Further paver functions such as speeds of tamper and vibrators or feed rate of the augers can easily be set up via the display, too. And the display gives access to machine-related information such as fuel consumption or service hours.



PaveDock Assistant (option)

With the PaveDock Assistant signal lights, the paver operator can give the driver of the feed vehicle unmistakable signals, indicating what needs to be done (e.g. reverse, stop, dump mix). The lights are conveniently activated directly from the paver operator's ErgoPlus 3 console.



Choice of engine speed ranges

For the engine, there is a choice of three modes to select from: MIN, ECO and MAX. To switch modes for engine rpm, all the operator needs to do is press the arrow buttons, up or down. In ECO mode, the engine delivers sufficient power for a great number of paving applications. Operating in ECO mode reduces noise emissions and fuel consumption considerably.



Screed Assist (option)

This button switches Screed Assist on (LED lights up) or off. Screed Assist pressure and balance can be set via the display. Screed Assist is active only when the screed is floating.

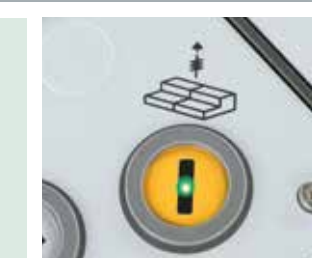

The ErgoPlus 3 screed console

The screed is crucial for pavement quality.

Therefore, easy and positive handling of all screed functions is of the utmost importance for high-quality road construction.

With ErgoPlus 3, the screed operator has the process of paving at his fingertips. All functions are easily comprehensible and all controls are clearly arranged.



The screed console

The screed console is designed in keeping with the conditions prevailing on the job site. Push-buttons are provided for the frequently used functions operated from the screed console. These are watertight and enclosed in palpably raised rings, so that they are identifiable blindfold simply by touch even when wearing work gloves. Important paver and screed data can be called up and adjusted from the screed console, too.



The display of the screed console

The display of the screed console allows the screed operator to control and monitor both the left and the right side of the screed. Machine-related parameters such as tamper speed or conveyor speed can be adjusted conveniently via the display panel of the screed console. The clear menu structure, combined with easily understandable, self-explanatory symbols neutral in language, makes operating the display panel both simple and safe.

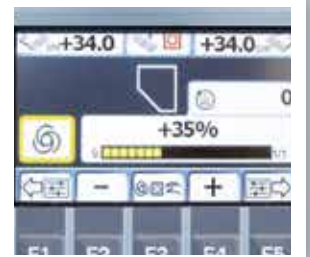

Crown adjustment at the press of a button

The crown can be conveniently adjusted at the press of a button on the screed operator's console. When pressing the "plus" or "minus" keys, the set crown value is shown on the display.



Ergonomic screed width control in two speeds

The screed width can be effortlessly adjusted by means of the SmartWheel. This is done in two speeds: slow, for precisely control e.g. along an edge, or fast, for rapid extension or retraction of the screed.



Optimum visibility even in darkness

The screed console is specially designed for night-time operation. To prevent operator errors, the buttons are backlit as soon as dusk falls or in darkness. What's more, high-power downward-angled LED lighting gives the operator a perfect view of all processes associated with the side plate.



VÖGELE Niveltronic Plus

Niveltronic Plus, the System for Automated Grade and Slope Control, is an in-house development by JOSEPH VÖGELE AG based on many years of experience in grade and slope control technology. Easy operation, precision and reliability are its hallmarks, ensuring perfect mastery of all grade and slope control jobs.

This fully integrated system is optimally adapted to the machine technology of the Premium Line pavers. All wiring and connections, for instance, are integrated into the tractor unit and screed, effectively eliminating all risk of damage to these components.

VÖGELE naturally offer a particularly large and practical selection of sensors permitting versatile use of the Niveltronic Plus system. Whether car parks, roundabouts or highways need to be built or rehabilitated, VÖGELE offer the right sensor for every job site situation.

Sensors can be changed quickly and easily, for Niveltronic Plus automatically detects which sensor is connected, thus simplifying the configuration process for the user.



Left-hand side of screed	Right-hand side of screed
<p>The value (in cm) displays the height of the tow point ram on the left-hand side.</p>	<p>The value (in cm) displays the height of the tow point ram on the right-hand side.</p>
<p>Shows the value specified for the sensor on the left-hand side. For grade sensors, values are indicated in mm. When working with the slope sensor, values are indicated in percent.</p>	<p>Shows the value specified for the sensor on the right-hand side. For grade sensors, values are indicated in mm. When working with the slope sensor, values are indicated in percent.</p>
<p>Shows the type of sensor selected for the left-hand side. Displayed here in this example is the symbol of the sonic sensor used in Ground mode.</p>	<p>Shows the type of sensor selected for the right-hand side. Displayed here in this example is the symbol of the sonic sensor used in Ground mode.</p>
<p>Shows the actual value picked up by the sensor.</p>	<p>Shows the actual value picked up by the sensor.</p>
<p>Shows the sensitivity set for the sensor selected.</p>	<p>Shows the sensitivity set for the sensor selected.</p>





The ErgoPlus 3 operator's stand

1. The comfortable operator's stand gives an unobstructed view of all crucial areas on the paver such as material hopper, steering guide or screed.

2. The seats swinging out to the sides and an operator's stand of streamlined design provide for maximum visibility of the auger tunnel, permitting the paver operator to keep an eye on the head of mix in front of the screed at all times.

3. Working comfort
The paver operator's seat and console, as well as the screed consoles can now be adjusted even more easily to personal needs.

4. A place for everything and everything in its place
The operator's stand, with its streamlined design, is well organized, offering the paver operator a professional workplace. The operator's console can be protected by a shatter-proof cover to prevent wilful damage.

5. Hardtop gives excellent protection
The modern hardtop made of glass fibre-reinforced polymer material shelters the operator whether rain or shine.

6. Consistent service concept
All "Dash 3" pavers have a consistent maintenance concept with identical service intervals.

7. Safe and comfortable ascent
The walkway and comfortable middle ascent on the screed ensure safe and convenient access to the operator platform.

8. Ergonomic screeed console
The height and position of the console are easily adjusted. The high-contrast colour display can be read clearly from all angles.



Screed options for all paving applications

A powerful tractor unit calls for a screed to match. Each application has its particular requirements, so that in the end it's up to the users' everyday needs to decide which screed is the right one. For SUPER 1803-3i, we offer two screed options available in several versions as far as equipment with compacting systems is concerned.

The latest generation of VÖGELE extending screeds are particularly variable. The AB 500 and AB 600 come with a sturdy single-tube telescoping system. Working with highest precision, they offer quick screed width control accurate to the millimetre.

A feature truly out of the ordinary for a wheeled paver: SUPER 1803-3i also combines with the AB 500 Extending Screed in TP1 version for high compaction, an essential to pavements perfectly built up in layers, true to line and level.

The special tamper geometry of the extending screeds creates a flatter screed planing angle. This makes for a long service life of the screed plates and excellent results in terms of compaction and evenness.

Substantially less time is required for the screed to reach its operating temperature, even with the engine idling, thanks to intelligent generator management.

In automatic operation, the screed is heated in Alternating mode, which means that only one half is heated at any one time, thus sparing the engine and saving fuel.

Screed options for the SUPER 1803-3i

AB 500 TV

Built up to maximum pave width

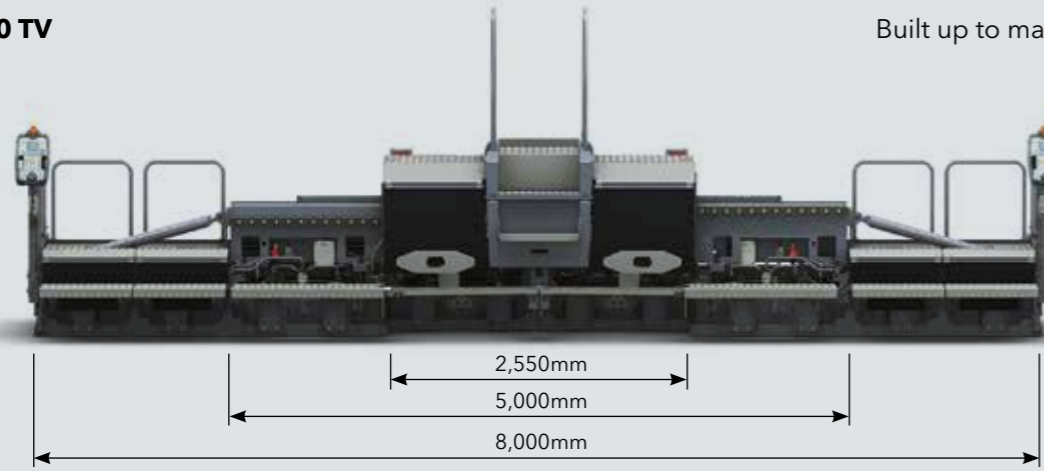

Pave widths

- » Infinitely variable range from 2.55m to 5m
- » Larger widths through the addition of bolt-on extensions up to a maximum of 8m

Compacting systems

- » AB 500 TV with tamper and vibrators
- » AB 500 TP1 with tamper and 1 pressure bar



AB 600 TV

Built up to maximum pave width

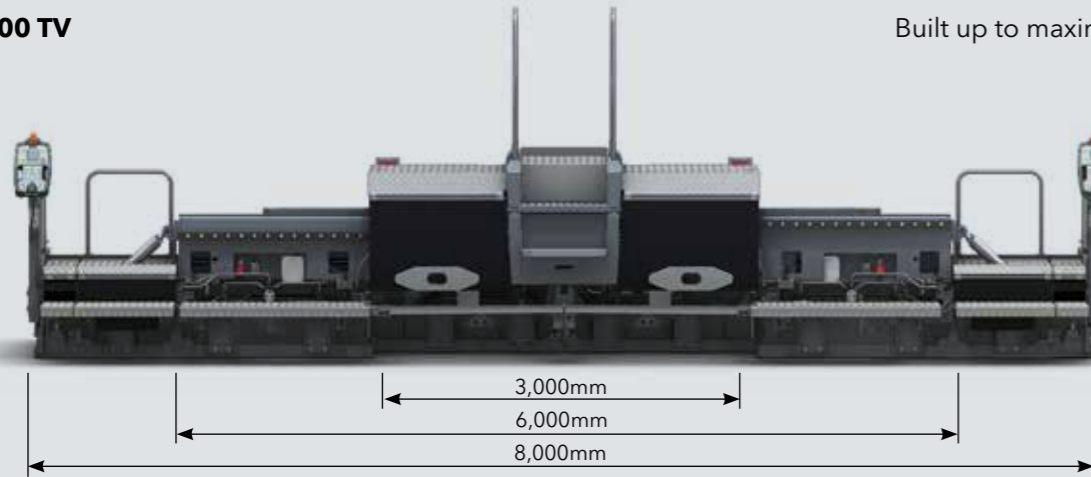

Pave widths

- » Infinitely variable range from 3m to 6m
- » Larger widths through the addition of bolt-on extensions up to a maximum of 8m

Compacting system

- » AB 600 TV with tamper and vibrators



All the facts at a glance

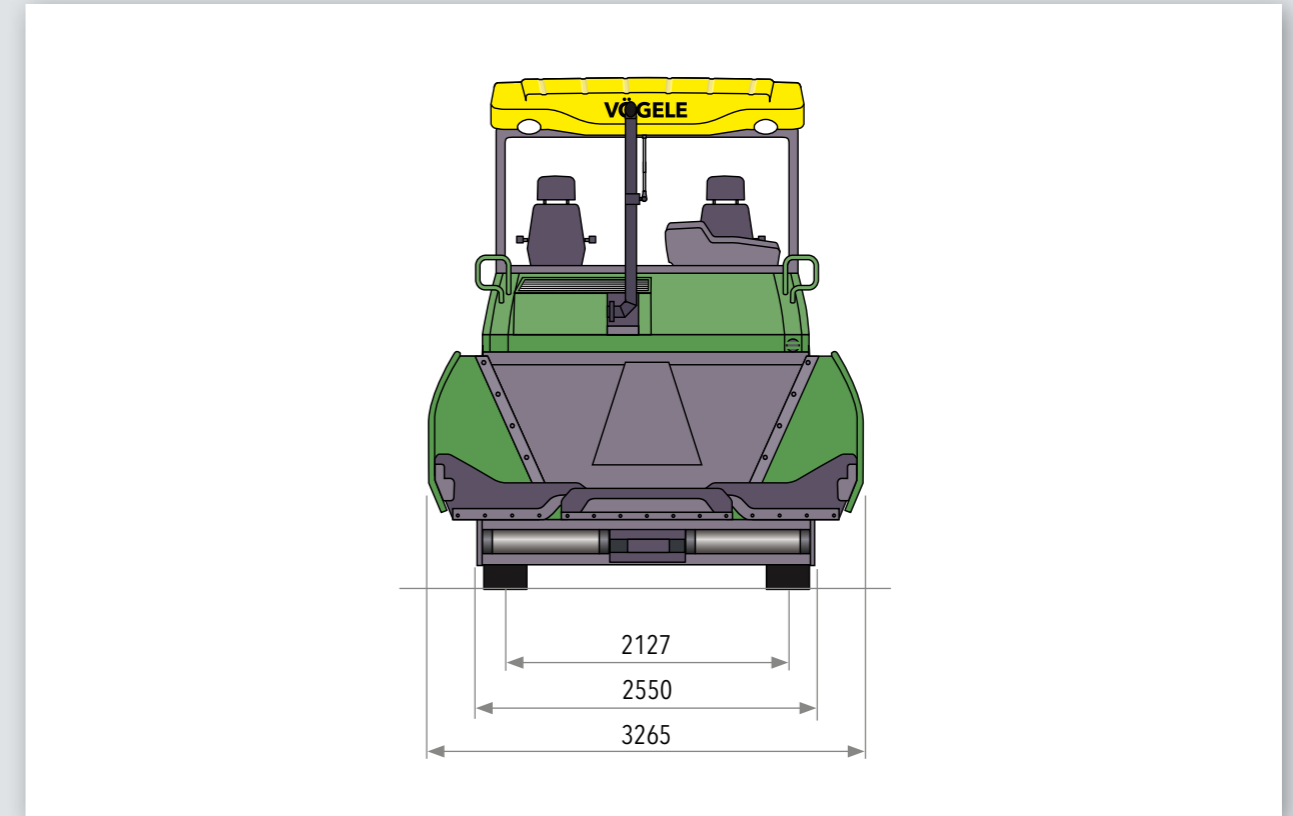
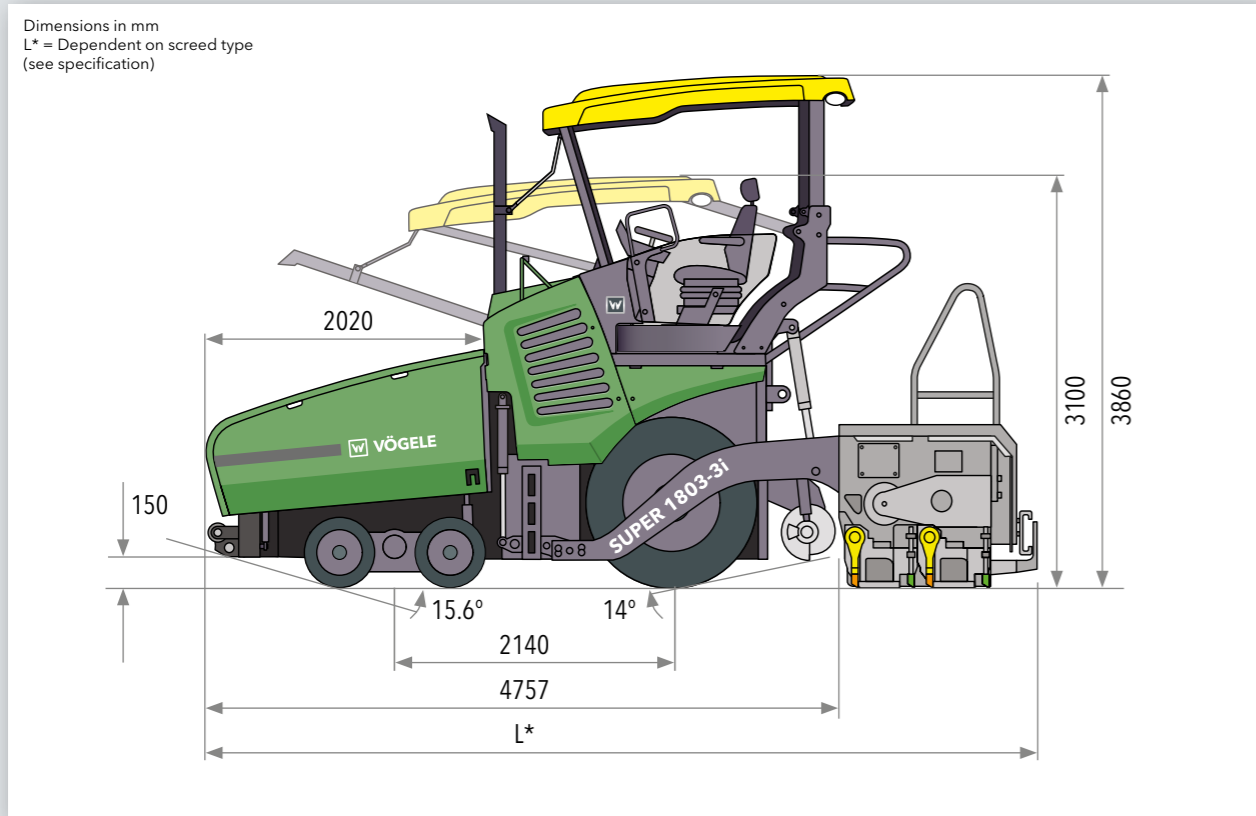

Power unit	
Engine	6-cylinder diesel engine, liquid-cooled
Manufacturer	Cummins
Type	QSB6.7-C164
Output	
Nominal	125kW at 2,000rpm (according to DIN)
ECO mode	121kW at 1,700rpm
Exhaust emissions standard	EU Stage 4, US EPA Tier 4f
Exhaust gas after-treatment	DOC, SCR
Emission data	
Sound power level	≤108 dB(A) (2000/14/EC and DIN EN 500-6)
Daily noise exposure level	>80 dB(A) (DIN EN 500-6)
Fuel tank	215 litres

Undercarriage	
Front wheels	4, mounted on bogies (oscillating axle)
Tyre equipment	solid tyres
Tyre size	540/300 - 390mm
Rear wheels	2, pneumatic tyres, tubeless
Tyre size	14.00 R 25
Drive	separate hydraulic drive provided for each wheel
Standard	2 rear wheels and 2 front wheels powered
Option	2 rear wheels and 4 front wheels powered (all-wheel drive)
Speeds	
Paving	up to 18m/min., infinitely variable
Travel	up to 20km/h, infinitely variable
Outside turning radius	3.5m (with Pivot Steer)
Material hopper	
Hopper capacity	13t
Width	3,265mm
Feed height	590 mm (centre of material hopper)
Push-rollers	oscillating
Position	can be adjusted lengthwise by 75mm or 150mm

Conveyors and augers	
Conveyors	2, with replaceable feeder bars, conveyor movement reversible for a short time
Drive	separate hydraulic drive provided for each conveyor
Speed	up to 33m/min., infinitely variable (manual or automatic)
Augers	2, with replaceable auger blades, auger rotation reversible
Diameter	400mm
Drive	separate hydraulic drive provided for each auger
Speed	up to 84rpm, infinitely variable (manual or automatic)
Height	infinitely variable by 15cm, hydraulic, lowest position 10cm above the ground
Lubrication	centralized lubrication system with electrically driven grease pump

Screed options		
AB 500	basic width	2.55m
	infinitely variable range	2.55m to 5m
	maximum width (TV/TP1)	8m
AB 600	basic width	3m
	infinitely variable range	3m to 6m
	maximum width (TV)	8m
Screed versions	TV, TP1 (AB 500)	
Layer thickness	up to 30cm	
Screed heating	electric by heating rods	
Power supply	three-phase A.C. generator	
Dimensions (transport) and weights		
Length	tractor unit and screed	
AB 500/AB 600	TV	6.04m
AB 500	TP1	6.17m
Weights	tractor unit and screed	
AB 500 TV	pave widths up to 5m	18,300kg
	pave widths up to 8m	20,800kg

Key: **DOC** = Diesel Oxidation Catalyst **AB** = Extending Screed **TV** = with tamper and vibrators
SCR = Selective Catalytic Reduction **TP1** = with tamper and 1 pressure bar

Subject to technical modification.



Your VÖGELE QR Code will take you directly to the "SUPER 1803-3i" on our website.



JOSEPH VÖGELE AG

Joseph-Vögele-Str. 1
67075 Ludwigshafen · Germany
www.voegele.info

T: +49 621 / 81 05 0
F: +49 621 / 81 05 461
marketing@voegele.info



® ERGOPLUS, InLine Pave, NAVITRONIC, NAVITRONIC Basic, NAVITRONIC Plus, NIVELTRONIC, NIVELTRONIC Plus, RoadScan, SprayJet, VÖGELE, VÖGELE PowerFeeder, PaveDock, PaveDock Assistant, AutoSet, AutoSet Plus, AutoSet Basic, ErgoBasic and VÖGELE-EcoPlus are registered Community Trademarks of JOSEPH VÖGELE AG, Ludwigshafen/Rhein, Germany. PCC is a registered German Trademark of JOSEPH VÖGELE AG, Ludwigshafen/Rhein, Germany. ERGOPLUS, NAVITRONIC Plus, NAVITRONIC BASIC, NIVELTRONIC Plus, SprayJet, VISION, VÖGELE, VÖGELE PowerFeeder, PaveDock, PaveDock Assistant, AutoSet, AutoSet Plus, AutoSet Basic and VÖGELE-EcoPlus are trademarks registered in the US Patent and Trademark Office to JOSEPH VÖGELE AG, Ludwigshafen/Rhein, Germany. Legally binding claims cannot be derived from written information or pictures contained in this brochure. Pictures may include optional extras. We reserve the right to make technical or design alterations.