

# CHEVALIER®

Grinding / Turning / Milling

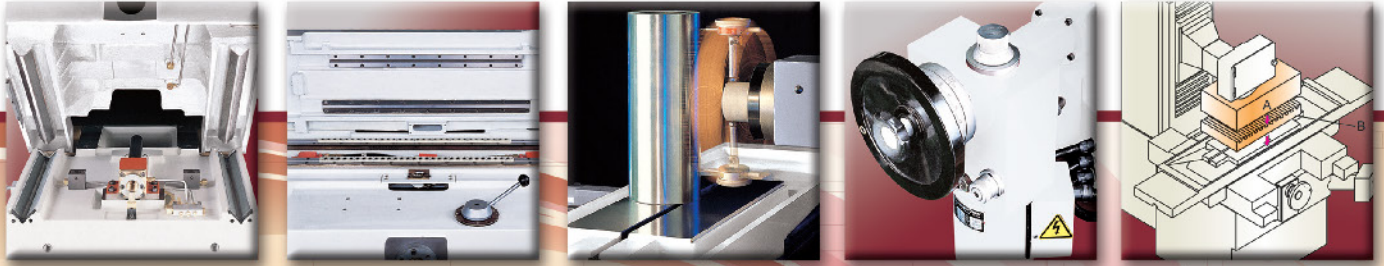

## FSG • SP Series

High Precision Surface Grinder

612SP • 618SP • 818SP  
FSG-618M • 2A618  
FSG-2A818 • 3A818  
FSG-2A1224 • 3A1224

# ACCUGRIND-612 • 618 • 818 SP

## Super Precision Surface and Form Grinder

### Machine Features

- Table traverses on linear ball bearings and D2 (SKD11) hardened and ground guideways.
- Reinforced ribbed column with hardened and ground guideway system.
- Elevating and crossfeed leadscrews are hardened and ground.
- Saddle travels on Turcite-B coated and hand-scraped double-V guideways.
- Vertical handwheel at waist level.
- 0.001mm (0.000050") vertical micro-feed device.
- Permanently lubricated and sealed cartridge-type spindle uses two pairs of Class 7(P4) angular contact ball bearings.
- 2HP dynamically balanced spindle motor.
- Automatic lubrication system.
- Main structure made of high quality cast iron.
- A mirror surface can be accomplished on these machines accurately and efficiently due to machine construction features and the specially designed V3 grade spindle motor that provide excellent rigidity and stability.

### Table Guideways

Table is driven by steel wire and traverses on hardened and ground guideways with steel ball bearings which have been accurately sieved. This provides smooth, accurate, and efficient table movement.

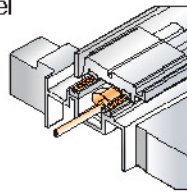

### Automatic Lubrication

The lubrication system provides lube oil to saddle, column ways, crossfeed and elevating leadscrews. This system minimizes the wear due to negligent operation, ensuring the machine accuracy and extending the life of machine. (3cc / 30 min ).

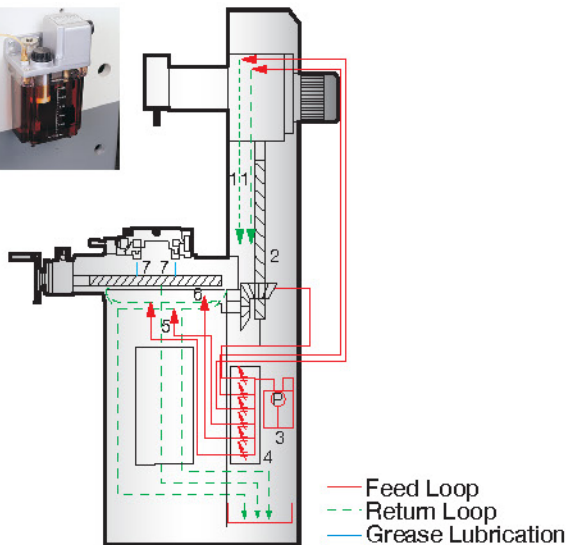

1. Column slideways
2. Elevating leadscrew
3. Lubricator
4. Oil Distributor
5. Machine base Double-V slideways
6. Crossfeed leadscrew
7. Table guideways with ball bearings are lubricated by grease.

### Durable Slideways

Machine-base slideways are laminated with Turcite-B and precisely hand-scraped, low-friction slideways incorporated with an automatic intermittent lubrication system to ensure high accuracy and longer life of slideways.

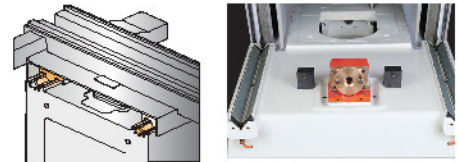

### 818SP

Note: Machine shown with optional accessories

# ACCUGRIND-612 • 618 • 818 SP

## Super Precision Surface and Form Grinder

### Permissible Load of Machine

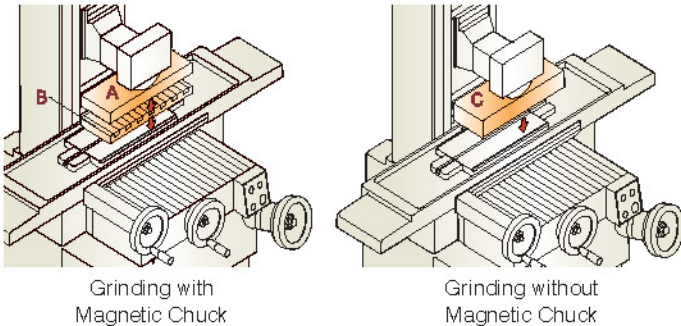

The total suggested maximum workloads of table are shown as follows:

MODEL	Kg (lbs.)		
	612SP	618SP	818SP
<b>A</b>	130 (286)	180 (396)	215 (474)
<b>B</b>	20 (44)	30 (66)	35 (77)
<b>C</b>	150 (330)	210 (462)	250 (551)

### High Precision Cartridge Type Spindle

Spindle is supported by four pieces of Class 7 (P4) super-precision angular-contact ball bearing. The bearings are accurately measured, selected and preloaded and assembled to ensure superior water resistance, longevity grinding accuracy and surface finish. The labyrinth seal type structure is designed to offer better water-resistance enhancing longevity of the spindle bearings.

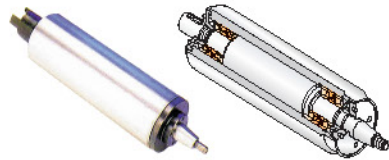

### Indexing Table Handwheel

The table handwheel can be indexed to a comfortable position to enhance the ease of table traverse.

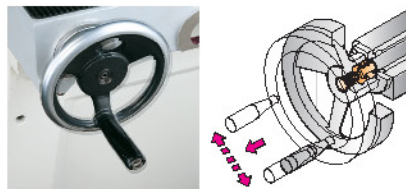

### Wheelhead and Column

The column casting is cross-ribbed for extra rigidity. The elevating guideways of wheelhead and column are hardened and ground. The sliding surfaces of the wheelhead are laminated with Turcite-B, providing accuracy of downfeed and machine longevity.

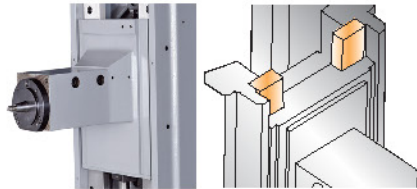

### Elevating Micro-Feed Device

The micro-feed device utilizes a worm and worm gear for vertical feeds in increments of 1µm (0.000050"). The micro-feed device is engaged by turning the lever clockwise, which also locks the handwheel to prevent any danger caused by accidentally touching the handwheel. Operation of the handwheel can be resumed by turning the lever counter-clockwise.

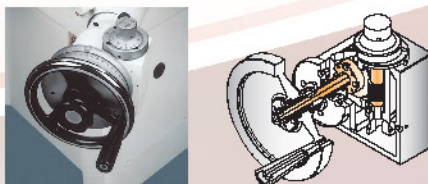

### Typical Accuracy

#### Parallelism of upper and lower sides of the workpiece within 0.002mm (0.0001") Conditions:

- Material: SAE1045 (S45C), HRC45
- Workpiece Size: Ø25.4 x 25.4mm (1" x 1")
- Grinding Wheel: 38A46H (or equivalent)
- Dressing Speed: 60~360 mm/min. (0.04~0.24inch/sec.)
- Specification of Dressing Diamond: 0.5~1.0 carat
- Dressing Depth: 0.003~0.006mm (0.0001"~0.0002")
- Table Speed: 10~20 m/min (33~66 fpm)
- Grinding Depth per Stroke: 0.001~0.005mm (0.000050"~0.0002")
- Room Temperature: 20~25°C (68~77°F)
- Grinding Wheel Size: Ø203 x 12.7 x Ø31.75mm (Ø8" x 1/2" x Ø1 1/4")



#### Surface finish better than (or equal to) Rmax 0.3S (3 micro inch AA) Conditions:

- Material: D2 (SKD11), HRC60
- Workpiece Size: 100 x 100mm (3.93" x 3.93")
- Grinding Wheel: ELBE 89A60-2111V26 (or equivalent)
- Dressing Speed: 60~360 mm/min. (0.04~0.24inch/sec.)
- Specification Of Dressing Diamond: 0.5~1.0 carat
- Dressing Depth: 0.01mm (0.0004")
- Table Speed: 10~20 m/min (33~65fpm)
- Grinding Depth Per Stroke: 0.001mm (0.000050")
- Crossfeed: 0.4mm (0.016")
- Room Temperature: 20~25°C (68~77°F)
- Grinding Wheel Size: Ø203 x 12.7 x Ø31.75mm (Ø8" x 1/2" x Ø1 1/4")

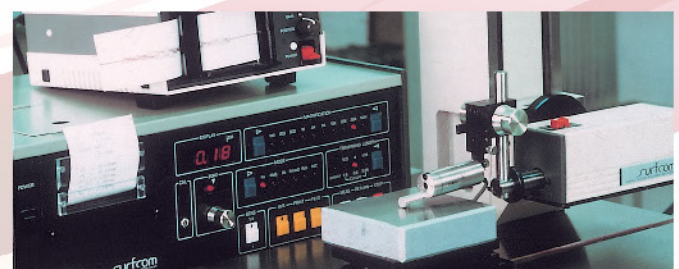

# FSG-618M • 2A618

## High Precision Surface Grinder

### Machine Features

- This high-precision surface grinder has been specially developed to help manufactures with a wide range of needs.
- The tool cabinet in the machine base is specially designed for operator's convenience (618M).
- The interlock between electrical cabinet door and power supply is established to ensure safe operation.
- The maximum distance from the table surface to the spindle centerline is 450mm (177"), which provides more clearance for grinding.
- The manual grinders feature a spring-loaded-type table travel-stops that dampen the over travel caused by abnormal operations.
- The optimum span of double-V crossfeed guideways is designed based on bending moment, kinematics and supporting force.
- All essential castings are high-grade Meehanite cast iron which the stress-relieved has been done through annealing to eliminate internal stress.
- With the impressive stiffness and stability of its castings, this machine is suitable for both precision surface grinding and form grinding.
- This grinder is offered with one-year warranty for mechanical and electrical parts.

### High Precision Cartridge Type Spindle

The spindle is supported by four pieces of Class 7 (P4) super-precision angular contact ball bearings, which have been accurately measured, selected and pre-loaded. Then it's assembled in a temperature controlled room to ensure better grinding accuracy and surface finish. The labyrinth seal type structure is designed to offer better water resistance, enhancing the longevity of the spindle bearings.

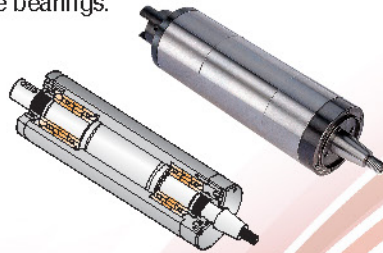

### Durable Slideways

Machine base slideways are laminated with Turcite-B and precisely hand scraped. The low-friction slideways incorporated with an automatic forced lubrication system ensures high-accuracy and longer way life.

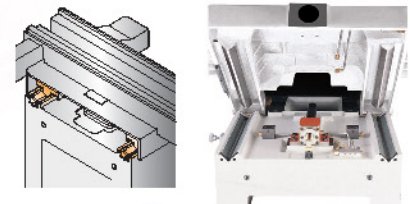

### Indexable-Table Handwheel

The table handwheel can be indexed to a comfortable position to enhance the ease of table traverse. (618M only)

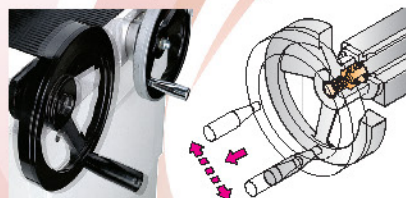

### Continuous-Loop-Type Table Transmission Mechanism

A continuous-loop wire reinforced-cog timing belt drives the table. This system ensures slip-free and smooth transmission of table, enabling at least three-times longer life of a continuous-cog timing belt compared to that of the wire type or reciprocating timing belt type. The table traverses on hardened and ground guideways with steel ball bearings providing smooth, accurate and efficient table movement (618M).

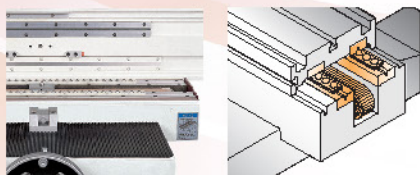

### FSG-618M

Note: Machine shown with optional accessories

# FSG-618M • 2A618

## High Precision Surface Grinder

### Permissible Load of Machine

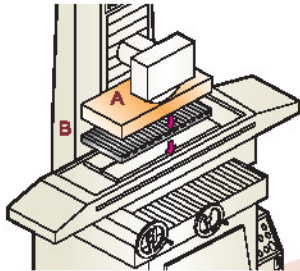

Grinding with Magnetic Chuck

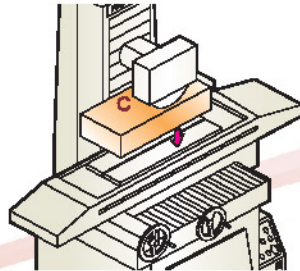

Grinding without Magnetic Chuck

The total suggested maximum workloads of table are shown as follows:

MODEL	FSG-618	FSG-2A618
A	180 (396)	
B	30 (66)	
C	210 (462)	

Kg (lbs.)

### Automatic Lubrication

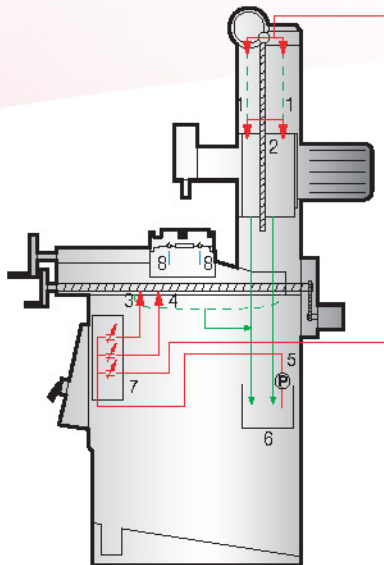

— Feed Loop  
— Return Loop  
— Grease Lubrication

1. Column slideways
2. Elevating leadscrew
3. Crossfeed leadscrew
4. Machine base Double-V slideways
5. Solenoid pump
6. Lubricator
7. Flow divider
8. Table guideways with ball bearings lubricated by grease

### Table Guide Ways (2A618)

The table transverse features hardened and ground guideways with steel ball bearings, which have been accurately sieved, for smooth, accurate and efficient table movement. (2A618)



### Table-Reversing Mechanism (2A618)

By using proximity switches, operator can easily set a suitable table stroke for each workpiece to save grinding time and to obtain higher grinding efficiency. The proximity switches have been properly covered for operator's safety (2A618).

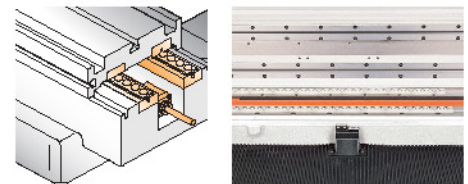

### FSG-2A618

Note: Machine shown with optional accessories

# FSG-2A818 • 3A818

## Automatic Surface Grinder

### Machine Features

This series has been specially developed and recently improved to continuously offer reliable high-performance precision surface grinders. The high-precision FSG-3A series surface grinder has recently improved the control panel with easy to read LED numerals. Chevalier offers a one year limited-warranty that includes parts for mechanical and electrical components.

The Double-V crossfeed guideway span has been designed by applying kinematics to calibrate for minimum bending moments, thus achieving maximum support capability for table and workpiece.

All essential castings are made of a high-grade cast iron that is stress relieved by annealing, ensuring the greatest stability and rigidity with low-stress.

An interlock is placed between the electrical cabinet door and the power supply as an added safety feature. The maximum distance from table surface to spindle centerline is 450mm (17.7"), which provides more clearance for grinding.

### High Precision Cartridge Type Spindle

The spindle is supported by four pieces of Class 7(P4) super-precision angular contact ball bearings. The bearing are accurately measured, selected and preloaded, then assembled to offer superior water resistance, increasing the life of the spindle bearings in the temperature-controlled rooms. This ensures better grinding accuracy and surface finish. The labyrinth seal type structure is designed to offer superior water resistance, increasing the life of the spindle bearings.

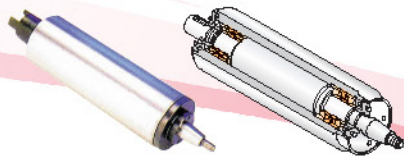

### Table Reversing Mechanism

By using proximity switches, the operator can easily set a suitable table stroke for each workpiece to save grinding time and obtain higher grinding efficiency. The proximity switches have been properly covered for the safety of operator.

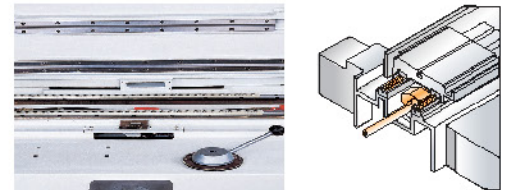

### Table Guideways

The table traverses on hardened and round guideways with accurately sieved steel ball bearings, providing smooth, accurate and efficient table movement.



### FSG-2A818

Note: Machine shown with optional accessories Longitudinal table movement is driven by hydraulic unit. Cross movement is driven by AC motor.

# FSG-2A818 • 3A818

## Automatic Surface Grinder

### Permissible Load of Machine

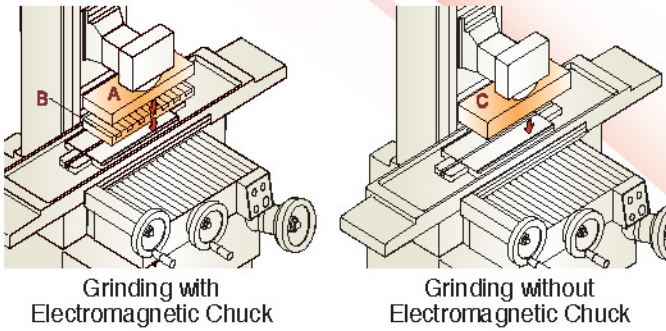

The total suggested maximum workloads of table are shown as follows:

A=Workpiece	B=Magnetic Chuck	C=A+B	Kg (lbs.)
MODEL	FSG-2A818	FSG-3A818	
A	215 (474)		
B	35 (77)		
C	250 (551)		

### Durable Slideways

Machine-base slideways are laminated with Turcite-B and precisely hand-scraped, low-friction slideways incorporated with an automatic intermittent lubrication system to ensure high accuracy and longer life of slideways.

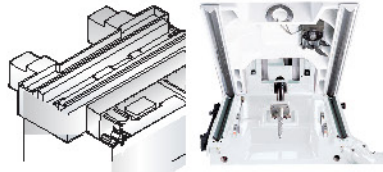

### Elevating Micro-Feed Device (FSG-3A818)

The elevating system is equipped with a precision 0.002mm (00001") graduated micro-feed device, consisting of a worm and wormgear for precise manual positioning of the Y-axis.

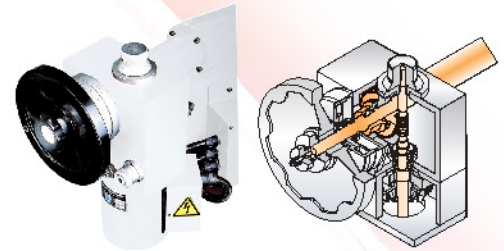

### Control Station (FSG-3A818)

The control station can be easily adjusted to a comfortable position for the operator's convenience. All switches, indicators, lamps, LEDs, and displays are ergonomically designed for easy operation.

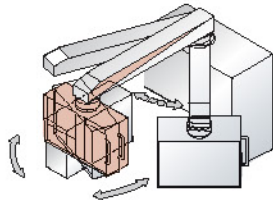

### FSG-3A818

Note: Machine shown with optional accessories. Longitudinal table movement is driven by hydraulic unit. Cross movement is driven by AC motor. Vertical feed is driven by AC motor and equipped with automatic downfeed device and manual micro downfeed device.



# FSG-2A1224 • 3A1224

## Automatic Surface Grinder

### Machine Features

This series has been specially developed and improved in recent years in order to continuously offer you reliable high performance precision surface grinders. And as a guarantee of that reliability we offer one year limited-warranty including parts for mechanical and electrical components. The Double-V crossfeed guideway span has been designed applying kinematics to calibrate minimum bending movements to

achieve maximum support capability for table and workpiece. All of high-grade cast iron that is stress-relieved by annealing to ensure superior stability and rigidity. An interlock has been placed between the electrical cabinet door and power supply as an added safety feature. The maximum distance from table surface to spindle centerline is 630mm(24.8") which provides more space for grinding.

### Longitudinal Slideways

The longitudinal slideways are laminated with Turcite-B and precisely hand scraped. The low-friction slideways incorporated with automatic forced lubrication system ensures high accuracy and longer way life.

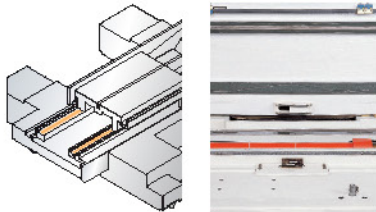

### Durable Slideways

Machine base slideways are laminated with Turcite-B and precisely hand-scraped. The low-friction slideways incorporated with automatic forced lubrication system ensures high accuracy and longer life of slideways.

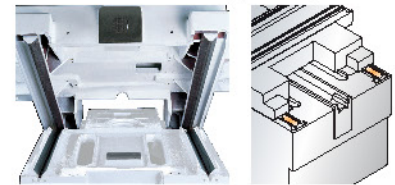

### High-Precision-Type Spindle

The spindle is supported by four pieces of Class 7(P4) super-precision angular-contact ball bearing. The bearings have been accurately measured, selected and preloaded and then assembled to ensure superior water resistance, longevity grinding accuracy and surface finish. The labyrinth seal type structure is designed to offer superior water resistance, increasing the life of the spindle bearings.

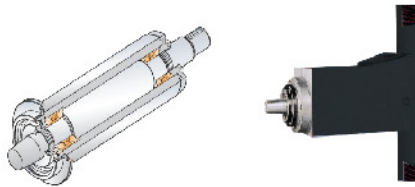

### Table Reversing Mechanism

By using proximity switches, operator can easily set suitable table stroke for each workpiece to save grinding time and obtain higher grinding efficiency. The proximity switches are properly covered for operator's safety.

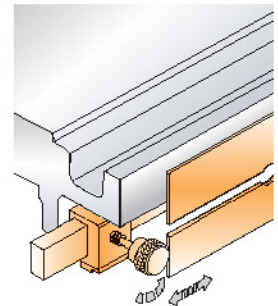

### FSG-2A1224

Note: Machine shown with optional accessories



# FSG-2A1224 • 3A1224

## Automatic Surface Grinder

### Permissible Load of Machine

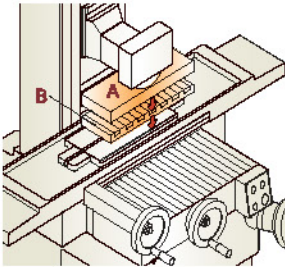

Grinding with  
Electromagnetic Chuck

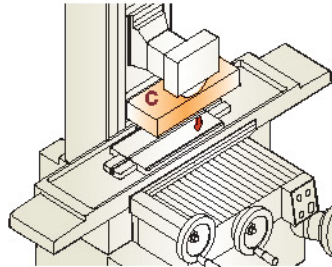

Grinding without  
Electromagnetic Chuck

The total suggested maximum workloads of table are shown as follows:

MODEL	Kg (lbs.)	
	FSG-2A1224	FSG-3A1224
A	314 (691)	
B	106 (233)	
C	420 (924)	

### Control Station (3A Series)

The control station can be adjusted to a comfortable position for operator. All switches, indicators, lamps, LEDs, and displays are designed as ergonomic concept for easy operation.

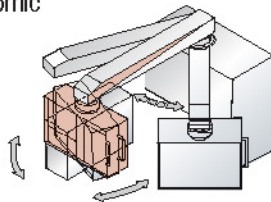

### Elevating Micro-Feed Device (3A Series)

The stepping downfeed device is very convenient for rough- and fine-grinding. By pushing down the step-feed button, the infeed wheelhead will be 25µm (000001") or 5µm (00002") selected by a selector at the top of this device. At the upper position there is an adjustable handle for approaching and rough-grinding.

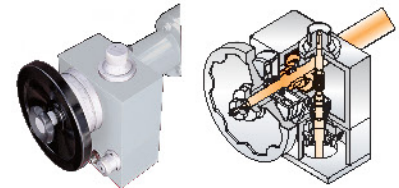

### FSG-3A1224

Note: Machine shown with optional accessories

## Optional Accessories



### Halogen Lamp

B01-0101 (618M / 2A618, 612SP / 618SP / 818SP)  
B01-0601 (3A818)  
B01-0901 (2A818)  
(12V / 20W)



### Machine Lamp

B01-0903 (2A, 3A1224)  
(12V / 50W)



### Diamond Dresser

B03-0101 (618M / 2A618)  
0.1 Carat  
B03-0401 (2A, 3A1224)  
1.0 Carat



### Diamond Dresser

B03-0601  
(2A, 3A818, 612SP / 618SP / 818SP)  
0.5 Carat

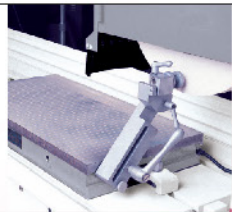

### Single Face Dresser

B13-0301 (2A, 3A1224)



### Wheel Flange

B05-0101 (618M / 2A618, 612SP / 618SP / 818SP, 2A, 3A818)  
Suitable for  $\varnothing 203 \times \varnothing 31.75 \times 12.7 \sim 19$ mm  
(8" x 1 1/4" x 1/2"~3/4") grinding wheel



### Wheel Flange

B05-0401 (2A, 3A1224)  
Suitable for  $\varnothing 355 \times \varnothing 127 \times 50$ mm  
(13.97" x 5" x 1.97") grinding wheel



### Punch Former

B07-01011 All series  
Diameter of the punch: 4~25mm  
(0.16"~1")  
Length of the punch: over 22mm (7/8")



### Permanent Magnetic Chuck

B09-0102 (618M / 2A618)  
150 x 450mm (5 7/8" x 17 3/4")  
B09-0103 (2A, 3A818, 818SP)  
200 x 450mm (7 7/8" x 17 3/4")  
B09-0101 (612SP)  
B09-0602 (612SP)(fine pole)  
150 x 300mm (5 7/8" x 11 7/8")  
B09-0102 (618SP)  
B09-0110 (618SP) (fine pole)  
150 x 450mm (5 7/8" x 17 3/4")  
B09-0103 (818SP)  
B09-0604 (818SP) (fine pole)  
200 x 450mm (7 7/8" x 17 3/4")



### Inclinable Magnetic Chuck

B09-0104 (612SP)  
100 x 175mm (3 15/16" x 6 7/8")  
B09-0105 (618M / 2A618, 618SP / 818SP, 2A, 3A818)  
150 x 300mm (5 7/8" x 11 7/8")

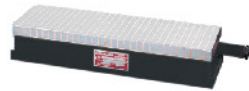

### Electromagnetic Chuck

B09-0605 (612SP)  
B09-0608 (612SP) (fine pole)  
150 x 300mm (5 7/8" x 11 7/8")  
B09-0106 (618M / 2A618, 618SP)  
150 x 450mm (5 7/8" x 17 3/4")  
B09-06071 110V (2A, 3A818)  
200 x 450mm (7 7/8" x 17 3/4")  
\* To order B23-0701(2A) or B23-0602 (3A) chuck control is required.  
B09-0609 (618SP) (fine pole)  
150 x 450mm (5 7/8" x 17 3/4")  
B09-0607 (818SP)  
B09-0610 (818SP) (fine pole)  
200 x 450mm (7 7/8" x 17 3/4")  
\* To order B23-0901 control is required.  
B09-04011(2A, 3A1224)  
300mm x 600mm (11 3/4" x 23 5/8")  
\* To order B23-0701(2A) or B23-0602 (3A) chuck control is required.



### Inclinable Electromagnetic Chuck

B09-0601 (618M / 2A618)  
150 x 450mm (5 7/8" x 17 3/4")  
B09-1101 (612SP)  
100 x 175mm (3 15/16" x 6 7/8")  
B09-0107 (618SP / 818SP)  
150 x 300mm (5 7/8" x 11 3/4")  
B09-09011 100V (2A, 3A818)  
200 x 300mm (7 7/8" x 11 3/4")  
\* To order B23-0701(2A) or B23-0602 (3A) chuck control is required.

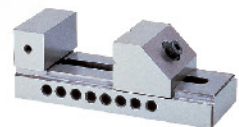

### Precision Vise (All Series)

B11-0101 50 x 76mm (2" x 3")  
B11-0102 63 x 100mm  
(2 31/64" x 3 15/16")  
B11-0103 76 x 100mm (3" x 3 15/16")  
B11-0104 89 x 127mm (3 1/2" x 5")  
B11-0105 100 x 127mm (3 15/16" x 5")



### Parallel Dressing Attachment (Manual)

B13-0101 (618M / 2A618)  
B13-1101 (612SP / 618SP / 818SP)  
B13-0603 (2A, 3A818)  
Suitable for 203mm (8") grinding wheel  
B13-0902 (2A, 3A1224)  
MAX. OD: 355mm (13.97")  
MIN. OD: 235mm (9.25")

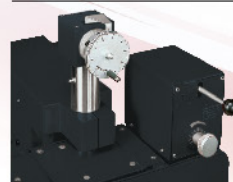

### Parallel Dressing Attachment (Hydraulic Crossfeed, Manual Downfeed)

B13-04011(2A, 3A1224)  
MAX. OD: 355mm (13.97")  
MIN. OD: 235mm (9.25")



### Parallel Dressing Attachment (Hydraulic Crossfeed, Manual Downfeed)

B13-0601 (2A, 3A818)  
Suitable for 203mm (8") grinding wheel



### Rapid Elevation with Micro Downfeed Device

(Standard on 3A series)  
B39-0901 (2A818 / 1224)  
Motor: 0.19kW (1/4 HP)  
Micro feed: Per revolution 0.2mm (0.01")  
Per graduation 0.002mm (0.0001")



### Micro Crossfeed Device

B39-1101 (612SP / 618SP / 818SP)  
Per revolution 0.1mm (0.005")  
Per graduation 0.001mm (0.00005")



### Rapid Elevation Device

B39-1102 (612SP / 618SP / 818SP)  
Motor: 0.19kW (1/4HP)  
Speed: 175mm/min. (8.75ipm) - 60Hz  
Speed: 145mm/min. (7.25ipm) - 50Hz



### Elbe Grinding Wheel

(for Mirror Surface Grinding)  
5915-44211002  
(81A46-3K9V26) (612SP / 618SP / 818SP)  
5915-44211005  
(81A46-3112V26) (612SP / 618SP / 818SP)



### Single Side Water Baffle

B19-0906 (2A, 3A818)

### Double Side Water Baffle

B19-0910 (2A, 3A1224)



### Splash Guard

(with Nozzle for Coolant System)  
B19-0102 (618M / 2A618)  
B19-0909 (2A, 3A818)  
B19-1101 (612SP)  
B19-1102 (618SP / 818SP)  
B19-0907 (2A, 3A1224)



### Balancing Stand with Bubble

B15-0102  
(612SP / 618SP / 818SP / 2A, 3A818)  
Suitable for  $\varnothing 230\text{mm}$  (9") grinding wheel



### Balancing Stand

(ROLLER TYPE) All Series  
B15-0601  
Suitable for  $\varnothing 203\sim 355\text{mm}$  (8"~13.98") grinding wheel

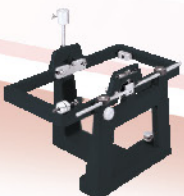

### Balancing Stand with Leveling Bubble

B15-0301 (2A, 3A1224)  
MAX. OD: 355mm (13.98")  
MAX. WIDTH: 50mm (1.97")



### Universal Wheel Guard for Side Forming

B41-0106 (618M / 2A618)  
B41-1101 (612SP / 618SP / 818SP)  
B41-0901 (2A, 3A818)  
Suitable for:  $\varnothing 203\text{mm}$  (8") grinding wheel



### Micro Downfeed Device

(Standard on 3A series)  
B39-0902 (2A818 / 1224)  
Micro feed: Per revolution 0.2mm (0.01")  
Per graduation 0.002mm (0.0001")



### Chuck Controller

(with variable holding power and auto demagnetizer)  
B23-0106 (618M / 2A618, 612SP / 618SP / 818SP)  
Input: 110VAC  
Output: 0~90VDC



### Chuck Controller

B23-0401 (3A818 / 1224 CE machines and all 2A818 / 1224 machines) (2A1224)  
Input: 135VAC  
Output: 115VDC



### Chuck Controller

B23-0602 (3A818 / 3A1224)  
Input Voltage: 135V AC  
Output Voltage: 110V DC  
with variable holding power control and auto. demagnetizer ( for CE machines, please choose B23-0401).



### Coolant System

B17-0110  
Volume: 42L  
Pump: 1/8HP  
Coolant Capacity: 20L/min.  
Space: 530 x 360mm (20.87" x 14 1/4")  
Height: 500mm (19 7/8")



### Coolant System with Double Filter

B17-0901  
Volume: 95L; Pump: 1/8 HP  
Coolant Capacity: 20L/min.  
Space: 660 x 480mm (26" x 18.9")  
Height: 610mm (24")



### Coolant System with Manual Paper Feeding Device (with 1 roll of Paper)

B17-0107 (2A, 3A1224)  
Volume: 85L; Pump: 1/8 HP  
Coolant Capacity: 20L/min.  
Space: 550 x 1,000mm  
(21 21/32" x 39 3/8")  
Height: 775mm (30 1/2")

## Optional Accessories

### Coolant System with Auto Paper Feeding Device



(with 1 roll of paper)  
**B17-0301 (2A, 3A1224)**  
 Volume: 120 L  
 Paper feeding motor: 25W  
 Pump: 1/8HP  
 Space: 1,450 x 620mm (57.1" x 24.4")  
 Height: 760mm (29.9")

### Coolant System with Auto Paper Feeding Device and Magnetic Separator



(with 1 roll of paper)  
**B17-0302**  
 Volume: 120L  
 Paper feeding motor: 25W  
 Pump: 1/8HP  
 Coolant Capacity: 20L/min.  
 Separator Capacity: 40L/min.  
 Space: 1,450 x 620mm (57.1" x 24.4")  
 Height: 760mm (29.9")

### Coolant System with Magnetic Separator



**B17-0105**  
 Volume: 50L  
 Pump: 1/8HP  
 Coolant Capacity: 20L/min.  
 Separator Capacity: 20L/min.  
 Space: 655 x 520mm  
 (25.8" x 20.5")  
 Height: 730mm (28.7")

### Combination Coolant and Dust Exhaust Unit with Magnetic Separator

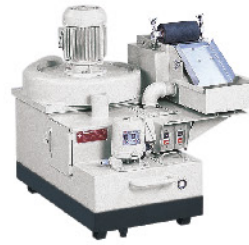

**B17-0106**  
 Volume: 34L  
 Pump: 1/8HP  
 Coolant Capacity: 20L/min.  
 Separator Capacity: 20L/min.  
 Space: 628 x 790mm  
 (24.7" x 31.1")  
 Height: 680mm (26.8")



### Combination Coolant and Dust Exhaust Unit

**B17-0101**  
 Volume: 34L  
 Pump: 1/8HP  
 Coolant Capacity: 20L/min.  
 Space: 398 x 798mm  
 (15.7" x 31.4")  
 Height: 680mm (26.8")



### Dust Collector

**B17-0102**  
 Suction Motor: 1/2HP , 2P  
 Space: 470 x 500mm  
 (18.5" x 19.7")  
 Height: 585mm (23")

## Standard Accessories

### 3A818/2A818

- |                         |                          |                         |
|-------------------------|--------------------------|-------------------------|
| 1. Tool box             | 8. Magnetic fixing bolt  | 14. Cross screwdriver   |
| 2. Wrench               | 9. Leveling bolt         | 15. Slotted screwdriver |
| 3. Semicircle wrench    | 10. plugs                | 16. Touch-up paint      |
| 4. Extractor nut        | 11. Lifting lever        | 17. Hex. wrench         |
| 5. Balancing arbor      | 12. Phillips head screws | 18. Grinding wheel      |
| 6. Leveling pads        | 13. Headless screws      | 19. Wheel flange        |
| 7. Magnetic locking nut |                          |                         |

### 3A1224/2A1224

- |                         |                         |                    |
|-------------------------|-------------------------|--------------------|
| 1. Tool box             | 7. Leveling bolt        | 13. Touch-up paint |
| 2. Wheel fixing bolt    | 8. plugs                | 14. Hex. wrench    |
| 3. Balancing arbor      | 9. Lifting lever        | 15. Grinding wheel |
| 4. Leveling pads        | 10. Headless screws     | 16. Wheel flange   |
| 5. Magnetic locking nut | 11. Cross screwdriver   |                    |
| 6. Magnetic fixing bolt | 12. Slotted screwdriver |                    |

## Dimensional Drawings

### ACCUGRIND-612SP / 618SP / 818SP

Unit: mm(")

MODEL	612SP	618SP	818SP
A	1,750 (68.89")	2,040 (80.3")	
B	685 (26.97")		
C	1,870 (73.6")	2,134 (84")	
D	1,360 (53.5")		
E	12.7 (0.5")		
F	267 (10.5")		
G	11 (0.433")		
H	152 (5.98")	200 (7.87")	
I	225 (8.9")	254 (10")	
J	244 (9.6")	242 (9.5")	
K	500 (19.69")		
L	203 (7.99")		
M	50 (1.96")		

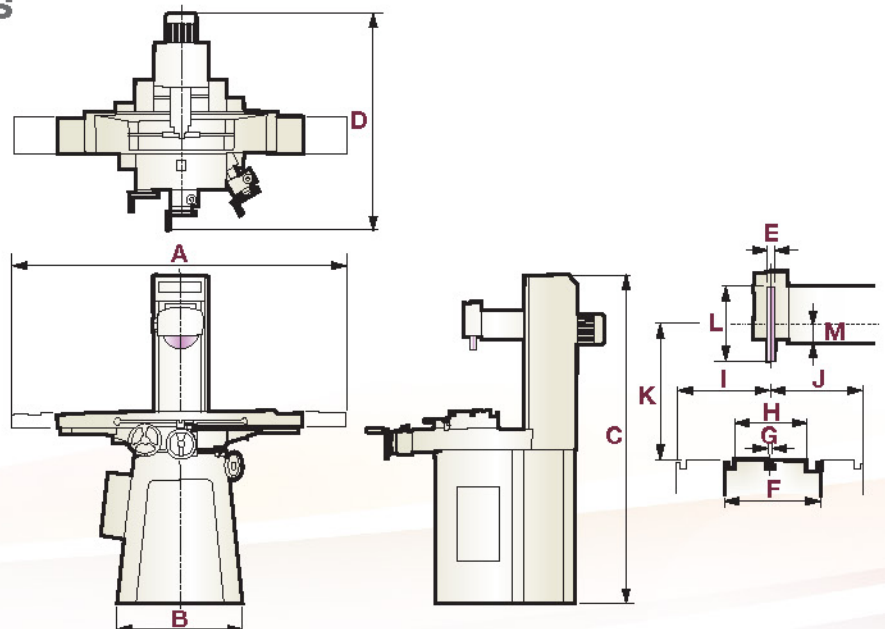

# Dimensional Drawings

## FSG-618M / 2A618

Unit: mm(")

MODEL	FSG-618M / FSG-2A618
A	1,900 (74.8")
B	690 (27.2")
C	2,130 (83.86")
D	1,400 (55.12")   1,600 (62.99")
E	12.7 (0.5")
F	200 (7.9")
G	11 (0.4")
H	146 (5.7")
I	197 (7.8")
J	183 (7.2")
K	450 (17.7")
L	203 (7.99")
M	50 (1.97")

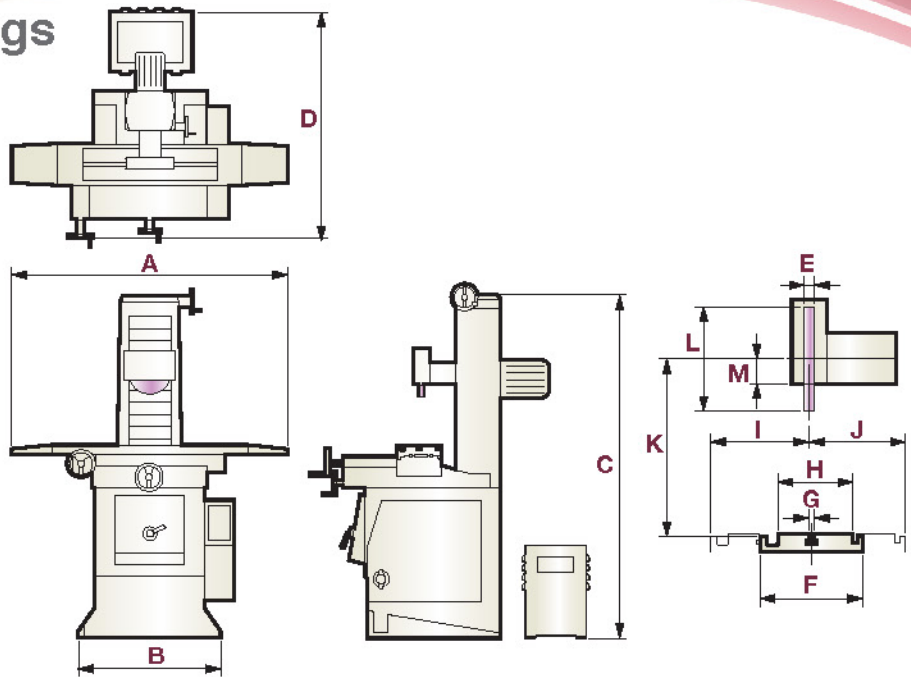

## FSG-2A818 / 3A818

Unit: mm(")

MODEL	FSG-2A818 / FSG-3A818
A	2,200 (86.6")
B	690 (27.2")
C	1,950 (76.77")
D	12.7 (0.5")
E	305 (12")
F	12 (0.5")
G	206 (8.1")
H	274 (10.8")
I	271 (10.7")
J	450 (17.7")
K	203 (8")
L	54 (2.1")

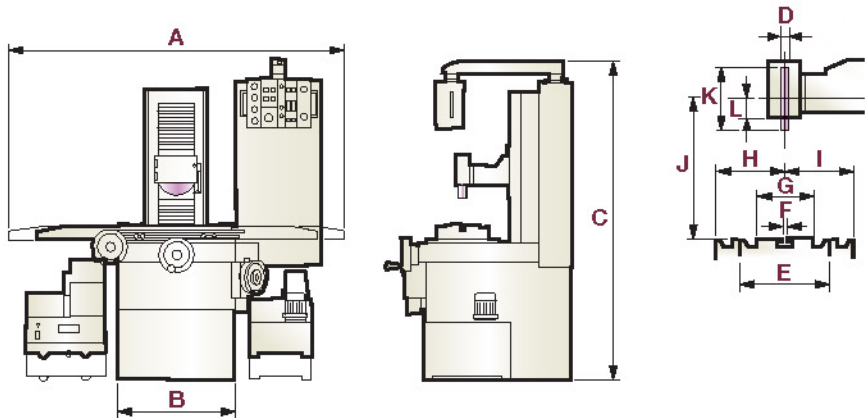

## FSG-2A1224 / 3A1224

Unit: mm(")

MODEL	FSG-2A1224 / 3A1224
A	2,670 (105.1")
B	920 (36.2")
C	2,050 (80.71")
D	1,810 (71.3")
E	50 (1.97")
F	402 (15.8")
G	14 (0.6")
H	305 (12")
I	385 (15.2")
J	387 (15.2")
K	MAX. : 600 (23.6")
L	355 (13.98")
M	83 (3.3")

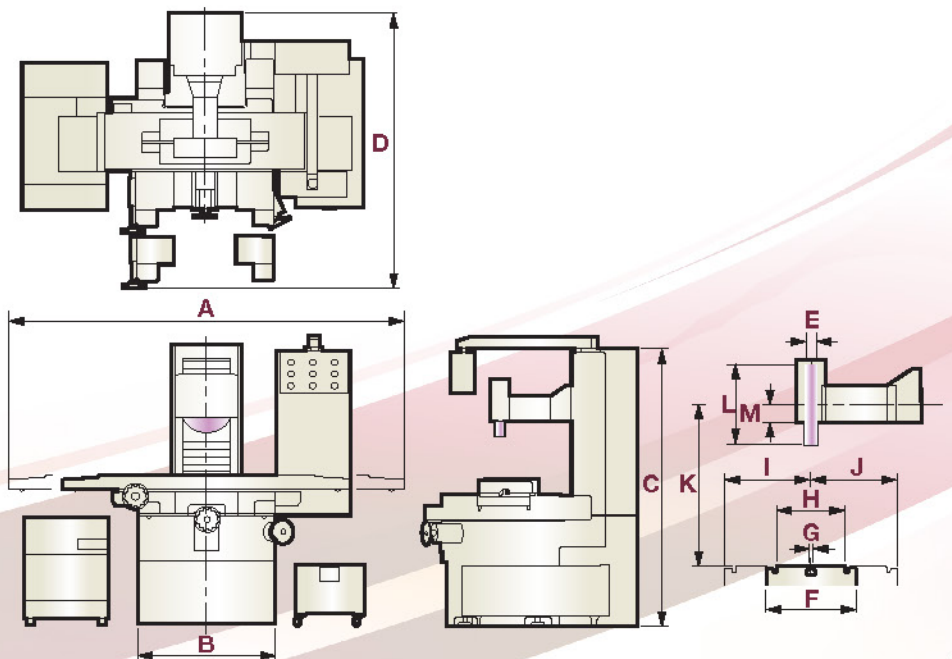

# Specification

Description		Unit	612SP	618SP	818SP
<b>Table size</b>		mm (")	152 x 330 (6" x 13")	152 x 480 (6" x 19")	203 x 480 (8" x 19")
<b>Max. grinding length</b>	Longitudinal	mm (")	355 (14")	500 (19")	
<b>Max.grinding width</b>	Crosswise	mm (")	203 (8")		230 (9")
<b>Max. distance from table</b>		mm (")	500(19")		
<b>Standard magnetic chuck size</b>		mm (")	150 x 300 (5.9" x 11.8")	150 x 450 (5.9" x 17.7")	200 x 450 (7.9" x 17.7")
<b>Longitudinal movement of table</b>	Travel, hydraulic	mm (")	N/A		
	Maxi. travel, manual	mm (")	360 (14")	510 (20")	
	Table speed, variable	m/mm (fpm)	N/A		
<b>Cross movement of table</b>	Rapid travel, approx.	m/mm (imp)	N/A		
	Auto increment	mm (")	N/A		
	Max. auto travel	mm (")	N/A		
	Max. manual travel	mm (")	203 (8")	230 (9")	
	Handwheel per revolution	mm (")	5 (0.2")		
	Handwheel per graduation	mm (")	0.02 (0.001")		
	Micro Feed	mm (")	Optional 0.001 (0.000050")		
<b>Wheelhead vertical infeed</b>	Automatic infeed	mm (")	N/A		
	Handwheel per revolution	mm (")	1 (0.05")		
	Handwheel per graduation	mm (")	0.005 (0.001")		
	Rapid travel, approx.	mm/min (ipm)	Optional 330 (13)		
	Micro feed	Per revolution	mm (")	0.02 (0.001")	
Per graduation		mm (")	0.001 (0.000050")		
<b>Grinding spindle drive</b>	Speed	Hz/rpm	60/3,450 , 50/2,850		
	Power rating	kW (HP)	1.5 (2)		
<b>Hydraulic drive</b>	Power rating	kW (HP)	N/A		
<b>Crossfeed drive</b>	Power rating	W (HP)	N/A		
<b>Elevating drive</b>	Power rating	kW (HP)	Optional 0.19 (1/4)		
<b>Standard grinding wheel</b>	Diameter	mm (")	Ø203 (8")		
	Width	mm (")	Optional 12.7 (0.5") , Max. 25.4 (1")		
	Bore	mm (")	Ø31.75 (1 1/4")		
<b>Floor space (L x W x H)</b>	Total space required	mm (")	1,750 x 1,360 x 1,870 (69" x 53.5" x 73.6")	2,040 x 1,360 x 2,134 (80" x 53.5" x 84")	
<b>Net weight</b>	Approx. Based on 3A	Kg (lbs.)	900 (1,980)	950 (2,090)	1,050 (2,310)
<b>Rated power</b>	approx	kW (HP)	1.65 (2.2)		
<b>Packing dimensions (L x W x H)</b>		mm (")	1,473 x 1,232 x 2,134 (58" x 48.5" x 84")		

• All content is for reference only and may be subject to change without notice or obligation.

	FSG-618M	FSG-2A618	FSG-2A818	FSG-3A818	FSG-2A1224	FSG-3A1224
	146 x 460 (5.7" x 18")		203 x 457 (8" x 18")		305 x 610 (12" x 24")	
	457 (18")		457 (18")		610 (24")	
	152 (6")		203 (8")		305 (12")	
	450 (17")		450 (17")		600(23")	
	150 x 450 (5.9" x 17.7")		200 x 450 (7.9" x 17.7")		300 x 600 (11.8" x 23.6")	
	N/A	500 (19.7")	500 (19.7")		650 (25.6")	
	482 (19")	510 (20")	530 (21")		700 (27.6")	
	N/A	5~25 (16~82 fpm)	5~25 (16~82 fpm)		5~25 (16~82 fpm)	
	N/A	960 (28 imp)	960 (48 imp)		1,100 (56 imp)	
	N/A	0.4~6 (0.02"~0.24")	0.4~6 (0.02"~0.24")		1~12 (0.04"~0.5")	
	N/A	171 (6.7")	230 (9")		360 (14.2")	
	180 (7")		240 (9.4")		370 (14.6")	
	3 (0.1")		4 (0.2")		4 (0.2")	
	0.01 (0.005")		0.02 (0.001")		0.02 (0.001")	
	N/A		N/A		N/A	
	N/A		N/A	0.002~0.04 (0.0001"~0.0002")	N/A	0.002~0.04 (0.0001"~0.0002")
	2 (0.1")		2 (0.1")		2 (0.1")	
	0.01 (0.0005")		0.01(0.0005")		0.01(0.0005")	
	N/A		N/A	330 (13)	N/A	330 (13)
	N/A		N/A	0.2(0.1)	N/A	0.2(0.1)
	N/A		N/A	0.002 (0.0001)	N/A	0.002 (0.0001)
	60/3,450 , 50/2,850		60/3,450 , 50/2,850		60/1,750 , 50/1,450	
	1.5 (2)		1.5 (2)		3.7 (5)	
	N/A	0.75 (1)	0.75 (1)		1.5 (2)	
	N/A	40 (0.05)	40 (0.05)		40 (0.05)	
	N/A		0.19 (1/4) Optional	0.19 (1/4) Standard	0.19 (1/4) Optional	0.19 (1/4) Standard
	Ø203 (8")		Ø203 (8")		Ø355 (14")	
	12.7 (0.5")		12.7 (0.5")		50 (2")	
	Ø31.75 (1 1/4")		Ø31.75 (1 1/4")		Ø127 (5")	
	1,900 x 1,400 x 2,130 (75" x 55" x 84")	1,900 x 1,600 x 2,130 (75" x 63" x 84")	2,200 x 1,575 x 1,950 (86" x 62" x 76")		2,670 x 1,810 x 2,050 (105" x 71" x 80")	
	680 (1,500)	800 (1,760)	1,320 (2,907)		2,100 (4,630)	
	1.65 (2.2)	2.5 (3.3)	3.7 (5)		7.4 (10)	
	1,120 x 1,016 x 2,160 (44" x 40" x 85")	1,550 x 1,120 x 2,130 (61" x 44" x 84")	1,854 x 1,549 x 2,210 (73" x 61" x 87")		2,743 x 1,905 x 2,235 (105" x 72" x 75")	

## Vertrauen Sie auf 70 Jahre Erfahrung!

Die Firma HESSE+CO wurde 1947 als Hersteller von Blechbearbeitungsmaschinen gegründet. Seit 1980 sind wir auf den Handel mit neuen sowie gebrauchten Blechbearbeitungs- und Werkzeugmaschinen spezialisiert. Wir haben ständig etwa 300 Maschinen in unserer 2.000 m<sup>2</sup> großen Ausstellungshalle, die nur 20 Minuten vom internationalen Flughafen Wien entfernt ist.

## Trust in 70 years of experience!

*HESSE+CO was established in 1947 as a manufacturer of sheet metal working machines. Since 1980 we are specialized in dealing with new and second hand sheet metal processing machines and machine tools. We always have approximately 300 machines available in our 2.000 m<sup>2</sup> showroom, which is located only 20 minutes from the Vienna International Airport, waiting for your inspection.*

# www.hesse-maschinen.com

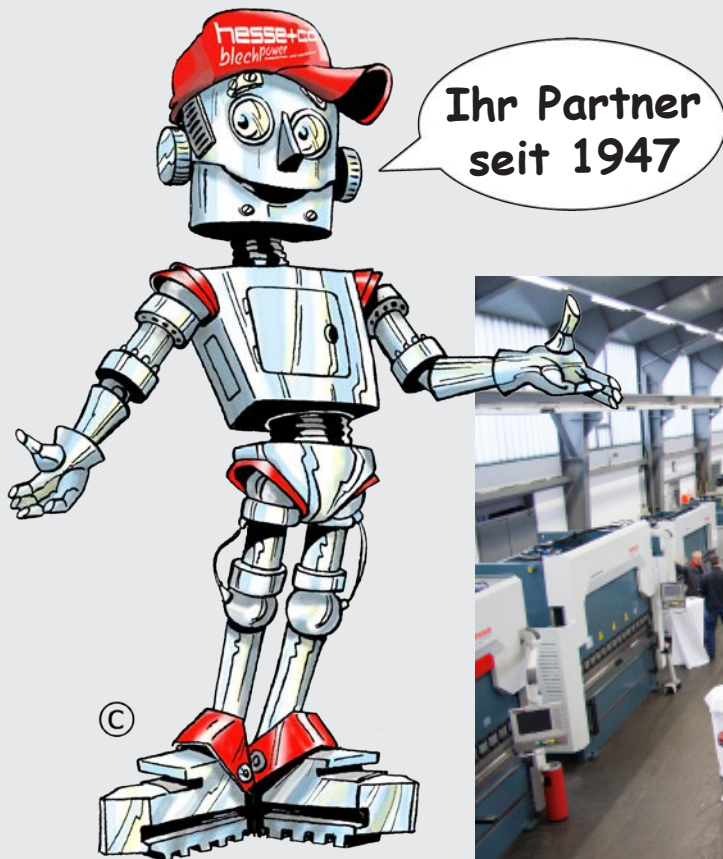

HESSE+CO Maschinenfabrik GmbH  
Industriezentrum NÖ-Süd  
Straße 4 - Objekt 8  
A-2351 Wiener Neudorf  
AUSTRIA

**hesse** **hesse+co**  
*blechpower*  
maschinen und werkzeuge

Technische Änderungen, Irrtum und Druckfehler vorbehalten.  
Gültig bis auf Widerruf.

Tel.: +43/2236/638 70-0  
Fax: +43/2236/636 62  
[office@hesse-maschinen.com](mailto:office@hesse-maschinen.com)  
[www.hesse-maschinen.com](http://www.hesse-maschinen.com)  
[www.blechpower.com](http://www.blechpower.com)