

563-391-7700

PROFESSIONAL SERIES



*TUBE, PIPE AND PROFILE*

**BENDING &  
METALWORKING  
MACHINERY**



**Manufacturer of**  
**Tube, Pipe and Profile**  
**Bending and Metalworking Machinery**

**W**elcome to CML USA, Inc., North American supplier of Ercolina® tube, pipe and profile bending machinery.

We are pleased to offer our customers the highest quality tube and pipe benders and related metal fabrication equipment available today. Ercolina's affordable tubing benders and fabricating machinery are designed to reliably and accurately produce your applications – increasing profit, improving product quality and finish.

Our product line is always expanding to include more manual, automatic and CNC pipe and tube bending machines, mandrel benders, NC swaging equipment and metalforming machinery. Ercolina's experienced sales, service and support staff is always ready to offer positive application solutions for today's fabricator.

**Company Profile:**

CML USA, Inc. consistently leads the industry providing quality metal fabricating equipment to commercial and professional metal fabricators in the United States, Canada, Mexico and South America. Our product line includes rotary draw tube and pipe bending machine equipment, NC and CNC mandrel benders, angle rolls, section benders and tube and pipe notchers, ornamental metalworking machinery and much more. Ercolina is recognized worldwide as one of the largest and most respected manufacturers of tube and pipe benders and metal fabricating machines.

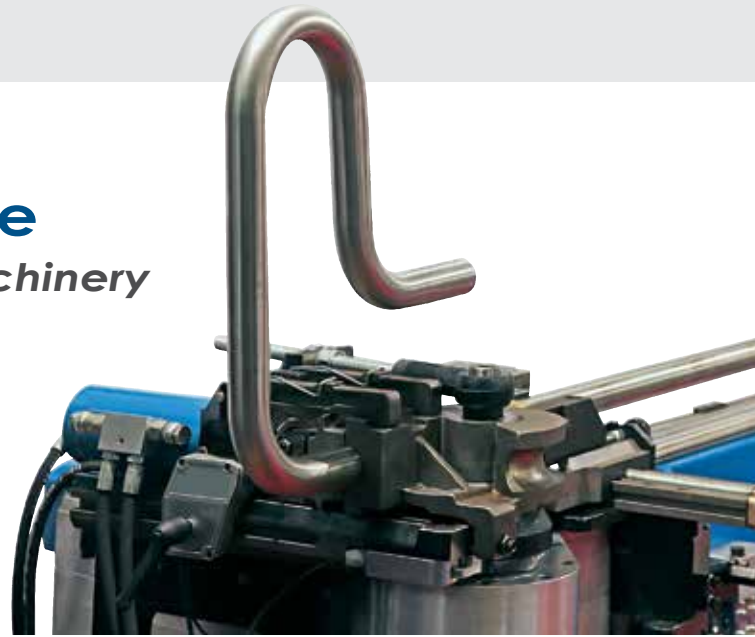

We invite you to tour our website or call our trained and knowledgeable product support representatives today at (563) 391-7700 to discuss your next bending application, speak with your regional Ercolina representative or arrange a demonstration of Ercolina products.



[ercolina-usa.com](http://ercolina-usa.com)

# ROTARY DRAW BENDERS

ROTARY DRAW BENDERS





# SB48 Super Bender®

## Tube & Pipe Bending Machine

**Fabricators Favorite**



Part# SB48  
machine only



### *Additional Savings when Purchasing Tooling Kit with Machine*

#### **SB48 with Pipe Kit Part# SB48P**

Pipe Size	CLR	Min. Wall	Center Former Part #	Counterbend Die Part #
1/2"	1.8	.109	153R046P0500	155P0500
3/4"	2.2	.113	153R056P0750	155P0750
1"	2.6	.133	153R067P1000	155P1000
1 1/4"	3.5	.140	153R090P1250	155P1250
1 1/2"	3.9	.145	153R100P1500	155P1500

**Pipe Kit only** Part# PIPEKIT2

#### **SB48 with "Small Radius" Tube Kit Part# SB48TSR**

Tube Size	CLR	Min. Wall	Center Former Part #	Counterbend Die Part #
3/4"	2.6	.035	153R067T0750	154T0750
7/8"	2.2	.065	153R056T0875	154T0875
1"	2.6	.065	153R067T1000	154T1000
1 1/4"	3.2	.083	153R082T1250	154T1250
1 1/2"	3.9	.083	153R100T1500	154T1500

"Small Radius" **Tube Kit only** Part# TUBEKIT2SR

#### **SB48 with "Large Radius" Tube Kit Part# SB48T**

Tube Size	CLR	Min. Wall	Center Former Part#	Counterbend Die Part#
3/4"	2.6	.035	153R067T0750	154T0750
7/8"	2.6	.035	153R067T0875	154T0875
1"	3.2	.035	153R082T1000	154T1000
1 1/4"	4.4	.035	153R112T1250	154T1250
1 1/2"	5.9	.049	153R150T1500	154T1500
1 3/4"	6.7	.065	153R170T1750	154T1750

"Large Radius" **Tube Kit only** Part# TUBEKIT2

## Store Multiple Bend Angles and Programs

### FEATURES

- Ideal for producing consistent quality bends in pipe, tube, squares, solids and other profiles
- Touch screen programming of bend angle with system diagnostics in multiple languages
- Quick-change tooling system with multiple radii available
- Digital display of bend angle
- Bend any angle to 180° with independent material springback compensation for each bend
- Foot pedal control for hands-free operation
- Swing away counterbending die vise for easy material handling
- Counterbending die position monitored electronically for accuracy and repeatability
- Accepts Ercolina's A40-P two axis positioning table for multiple and sequential bends
- Compact design with base wheels and lift handle
- No hydraulic components
- Individual tooling available on pages 15-25

## SB48 Capacities & Specifications

Tube (Min.)	¼"
(Max.)	2"
Pipe (Max.)	1½" Sch. 40
Centerline Radius (Min.)	2 x Ø
(Max.)	8⅞"
Degree of Bend	0-210°
Bending Speed	Variable
Programming	NC with Touchpad (30) programs (9) bends per program
Material Positioning Table	Available (see page 26)
Voltage	120V 1ph (3ph available)
Length, Width, Height	22½" x 16¼" x 39½"
Weight	300 lbs.

All capacities based on A53 grade A 48,000 psi tensile materials; heavy wall and high tensile materials reduce machine capacity. Consult supplier for material specifications.

### POPULAR ACCESSORIES



Tube & Pipe Tooling Kits



Spray Lubricant



Two Axis Positioner



Easy Part Layout Software



Square Tooling

Tooling Kits [Pages 15-16](#)

Tooling and Accessories [Pages 17-25](#)

Model Comparison Guide [Page 32](#)



◀ Ercolina Bending Application

**Product  
Demonstrations  
Available on Website**

**NEED ADDITIONAL HELP?  
CONTACT ERCOLINA:**

**563.391.7700**

[info@ercolina-usa.com](mailto:info@ercolina-usa.com)

[ercolina-usa.com](http://ercolina-usa.com)



# TB60 Top Bender<sup>®</sup>

## Tube & Pipe Bending Machine

**Fabricators Favorite**



**2 1/2"**  
Tube Capacity

**1 Year**  
Limited  
WARRANTY

Part# TB60  
machine only

### Additional Savings when Purchasing Tooling Kit with Machine

#### TB60 with Pipe Kit • Part# TB60P

Pipe Size	CLR	Min. Wall	Center Former Part #	Counterbend Die Part #
1/2"	1.8	.109	153R046P0500	155P0500
3/4"	2.2	.113	153R056P0750	155P0750
1"	2.6	.133	153R067P1000	155P1000
1 1/4"	3.5	.140	153R090P1250	155P1250
1 1/2"	3.9	.145	153R100P1500	155P1500
2"	5.9	.109	153R150P2000	155P2000

Pipe Kit only Part# PIPEKIT1

#### TB60 with "Small Radius" Tube Kit Part# TB60TSR

Tube Size	CLR	Min. Wall	Center Former Part #	Counterbend Die Part #
3/4"	2.6	.035	153R067T0750	154T0750
7/8"	2.2	.065	153R056T0875	154T0875
1"	2.6	.065	153R067T1000	154T1000
1 1/4"	3.2	.083	153R082T1250	154T1250
1 1/2"	3.9	.083	153R100T1500	154T1500
2"	5.9	.095	153R150T2000	154T2000

"Small Radius" Tube Kit only Part# TUBEKIT1SR

#### TB60 with "Large Radius" Tube Kit Part# TB60T

Tube Size	CLR	Min. Wall	Center Former Part #	Counterbend Die Part #
3/4"	2.6	.035	153R067T0750	154T0750
7/8"	2.6	.035	153R067T0875	154T0875
1"	3.2	.035	153R082T1000	154T1000
1 1/4"	4.4	.035	153R112T1250	154T1250
1 1/2"	5.9	.049	153R150T1500	154T1500
1 3/4"	6.7	.065	153R170T1750	154T1750
2"	7.5	.065	153R190T2000	154T2000

"Large Radius" Tube Kit only Part# TUBEKIT1

## Ercolina's Most Popular Workhorse

### FEATURES

- Ideal for producing consistent quality bends in pipe, tube, squares, solids and other profiles
- Touch screen programming of bend angle with system diagnostics in multiple languages
- Quick-change tooling system with multiple radii available
- Digital display of bend angle
- Bend any angle to 180° with independent material springback compensation for each bend
- Two bend speeds
- Foot pedal control for hands-free operation
- Swing away counterbending die vise for easy material handling
- Counterbending die position monitored electronically for accuracy and repeatability
- Accepts Ercolina's A40-P two axis positioning table for multiple and sequential bends
- Compact design with base wheels and lift handle
- No hydraulic components
- Individual tooling available on pages 15-25

## TB60 Capacities & Specifications

Tube (Min.)	¼"
(Max.)	2½"
Pipe (Max.)	2" Sch. 40
Centerline Radius (Min.)	2 x Ø
(Max.)	15"
Degree of Bend	0-210°
Bending Speed	Variable
Programming	NC with Touchpad (30) programs (9) bends per program
Material Positioning Table	Available (see page 26)
Voltage	220V or 480V 3ph
Length, Width, Height	27" x 15" x 36"
Weight	430 lbs.

All capacities based on A53 grade A 48,000 psi tensile materials; heavy wall and high tensile materials reduce machine capacity. Consult supplier for material specifications.

### POPULAR ACCESSORIES



**Tube & Pipe Tooling Kits**



**Spray Lubricant**



**Two Axis Positioner**



**Easy Part Layout Software**

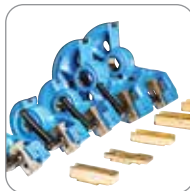

**Square Tooling**

**Tooling Kits** [Pages 15-16](#)

**Tooling and Accessories** [Pages 17-25](#)

**Model Comparison Guide** [Page 32](#)

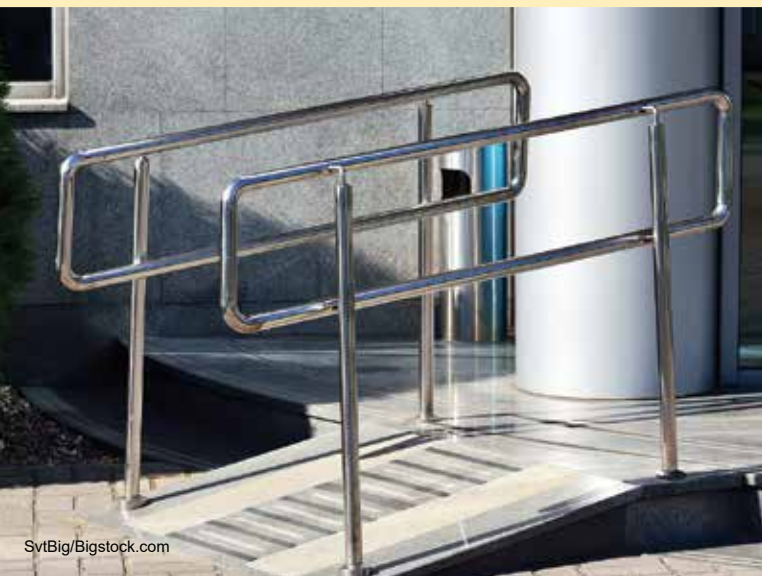

◀ **Ercolina Bending Application**

**Product  
Demonstrations  
Available on Website**

**NEED ADDITIONAL HELP?  
CONTACT ERCOLINA:**

**563.391.7700**

[info@ercolina-usa.com](mailto:info@ercolina-usa.com)

[ercolina-usa.com](http://ercolina-usa.com)



# TB80 Top Bender®

## Tube & Pipe Bending Machine

**Additional Savings when Purchasing Tooling Kit with Machine**

**TB80-4 (480V 3ph) with Pipe Kit • Part# TB80-4P**  
**TB80 (220V 3ph) with Pipe Kit • Part# TB80P**

Pipe Size	CLR	Min. Wall	Center Former Part #	Counterbend Die Part #
1"	2.6	.133	153R067P1000	155P1000
1¼"	3.5	.140	153R090P1250	155P1250
1½"	3.9	.145	153R100P1500	155P1500
2"	5.9	.109	153R150P2000	155P2000
2½"	10.2	.203	157R260P2500-80	155P2500

**Pipe Kit only** Part# PIPEKIT6

**TB80-4 (480V 3ph) with "Large Radius" Tube Kit**  
**Part# TB80-4TLR**

**TB80 (220V 3ph) with "Large Radius" Tube Kit**  
**Part# TB80TLR**

Tube Size	CLR	Min. Wall	Center Former Part#	Counterbend Die Part#
1"	3.2	.035	153R082T1000	154T1000
1¼"	4.4	.035	153R112T1250	154T1250
1½"	5.9	.049	153R150T1500	154T1500
1¾"	6.7	.065	153R170T1750	154T1750
2"	7.5	.065	153R190T2000	154T2000

**"Large Radius" Tube Kit only** Part# TUBEKIT5

Part# TB80-4  
 machine only



Tube Capacity



## Auto Load Sensing Improves Torque

### FEATURES

- Ideal for producing consistent quality bends in large pipe, tube, squares, solids and other profiles with auto tune
- Touch screen control icon menu for easy access to auto and manual operating modes, programming (inch or metric), system diagnostics and multiple language capability
- Quick-change tooling system with multiple radii available
- Digital display of bend angle and bend speed
- Bend any angle to 180° with independent material springback and speed compensation for each bend
- Foot pedal control of bend and return functions
- Swing away counterbending die vise for easy material handling
- Counterbending die vise position monitored electronically for accuracy and repeatability
- Heavy-duty steel gear case, right or left bend capable
- No hydraulic components for quiet operation
- Mandrel ready with optional accessory
- Two axis positioning table for multiple and sequential bends available on special request
- On screen machine diagnostics
- Individual tooling available on pages 15-25



## TB80 Capacities & Specifications

Tube (Min.)	1/4"
(Max.)	3" (.120 wall)
Pipe (Max.)	2 1/2" Sch. 40 Grade B A53
Centerline Radius (Min.)	2 x Ø (3" CLR with standard tooling)
(Max.)	16.5"
Degree of Bend	0-210°
Bending Speed	Variable 1.5 to 3 RPM
Programming	Touch screen - 7" Unlimited storage with USB (30) bends per program
Material Positioning Table	Consult factory
Voltage	480V 3ph standard (220V 3ph available)
Length, Width, Height	20" x 34" x 47"
Weight	980 lbs.

All capacities based on A53 grade B 60,000 psi tensile materials; heavy wall and high tensile materials reduce machine capacity. Consult supplier for material specifications.

### POPULAR ACCESSORIES



Tube & Pipe Tooling Kits



Spray Lubricant



Easy Part Layout Software

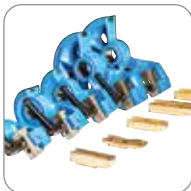

Large Square Tooling

Tooling Kits [Pages 15-16](#)

Tooling and Accessories [Pages 17-25](#)

Model Comparison Guide [Page 32](#)



◀ Ercolina Bending Application

**Product  
Demonstrations  
Available on Website**

**NEED ADDITIONAL HELP?  
CONTACT ERCOLINA:**

**563.391.7700**

**info@ercolina-usa.com**

**ercolina-usa.com**



# TB100 Top Bender®

## Tube & Pipe Bending Machine

**Additional Savings when Purchasing Tooling Kit with Machine**



### TB100 with Pipe Kit • Part# TB100P

Pipe Size	CLR	Min. Wall	Center Former Part #	Counterbend Die Part #
1¼"	3.5	.140	153R090P1250	155P1250
1½"	3.9	.145	153R100P1500	155P1500
2"	5.9	.109	153R150P2000	155P2000
2½"	11.8	.203	157R300P2500-80	155P2500
3"	11.8	.216	157R300P3000-80	155P3000

Pipe Kit only Part# PIPEKIT4

### TB100 with "Small Radius" Tube Kit Part# TB100TSR

Tube Size	CLR	Min. Wall	Center Former Part #	Counterbend Die Part #
¾"	2.6	.035	153R067T0750	154T0750
⅞"	2.2	.065	153R056T0875	154T0875
1"	2.6	.065	153R067T1000	154T1000
1¼"	3.2	.083	153R082T1250	154T1250
1½"	3.9	.083	153R100T1500	154T1500
2"	5.9	.095	153R150T2000	154T2000

"Small Radius" Tube Kit only Part# TUBEKIT1SR

### TB100 with "Large Radius" Tube Kit Part# TB100TLR

Tube Size	CLR	Min. Wall	Center Former Part#	Counterbend Die Part#
¾"	2.6	.035	153R067T0750	154T0750
⅞"	2.6	.035	153R067T0875	154T0875
1"	3.2	.035	153R082T1000	154T1000
1¼"	4.4	.035	153R112T1250	154T1250
1½"	5.9	.049	153R150T1500	154T1500
1¾"	6.7	.065	153R170T1750	154T1750
2"	7.5	.065	153R190T2000	154T2000

"Large Radius" Tube Kit only Part# TUBEKIT1

Part# TB100 machine only



## Accurately Bend Heavy Profiles

### FEATURES

- Ideal for producing consistent quality bends in large pipe, tube, squares, solids and other profiles
- Touch screen control offers easy access to auto and manual operating modes, programming (inch or metric), system diagnostics and multiple language capability
- Quick-change tooling system with multiple radii available
- Digital display of bend angle
- Bend any angle to 180° with independent material springback compensation for each bend
- Foot pedal control of bend and return functions
- Swing away counterbending die vise for easy material handling
- Counterbending die vise position monitored electronically for accuracy and repeatability
- Two axis positioning table for multiple and sequential bends available on special request
- Heavy-duty steel gear case
- No hydraulic components
- Individual tooling available on pages 15-25

## TB100 Capacities & Specifications

Tube (Min.)	1/4"
(Max.)	4"
Pipe (Max.)	3" Sch. 40
Centerline Radius (Min.)	2 x Ø
(Max.)	17"
Degree of Bend	0-210°
Bending Speed	Variable to 1.3 RPM
Programming	Touch screen Unlimited storage with USB (12) bends per program
Material Positioning Table	Consult factory
Voltage	220V or 480V 3ph
Length, Width, Height	20" x 34" x 47"
Weight	1,030 lbs.

All capacities based on A53 grade A 48,000 psi tensile materials; heavy wall and high tensile materials reduce machine capacity. Consult supplier for material specifications.

### POPULAR ACCESSORIES



**Tube & Pipe Tooling Kits**



**Spray Lubricant**



**Easy Part Layout Software**



**Roller Counterbending Die**

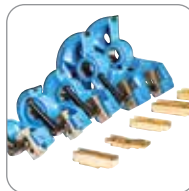

**Large Square Tooling**

**Tooling Kits [Pages 15-16](#)**

**Tooling and Accessories [Pages 17-25](#)**

**Model Comparison Guide [Page 32](#)**



◀ **Ercolina Bending Application**

**Product Demonstrations Available on Website**

**NEED ADDITIONAL HELP?  
CONTACT ERCOLINA:**

**563.391.7700**

**info@ercolina-usa.com**

**ercolina-usa.com**



# TB130 Top Bender®

## Tube & Pipe Bending Machine

**Additional Savings when Purchasing Tooling Kit with Machine**



### TB130 with Pipe Kit • Part# TB130P

Pipe Size	CLR	Min. Wall	Center Former Part #	Counterbend Die Part #
1¼"	3.5	.140	153R090P1250	155P1250
1½"	3.9	.145	153R100P1500	155P1500
2"	5.9	.109	153R150P2000	155P2000
2½"	11.8	.203	157R300P2500-80	155P2500
3"	11.8	.216	157R300P3000-80	155P3000

Pipe Kit only Part# PIPEKIT4

### TB130 with "Small Radius" Tube Kit Part# TB130TSR

Tube Size	CLR	Min. Wall	Center Former Part #	Counterbend Die Part #
¾"	2.6	.035	153R067T0750	154T0750
⅞"	2.2	.065	153R056T0875	154T0875
1"	2.6	.065	153R067T1000	154T1000
1¼"	3.2	.083	153R082T1250	154T1250
1½"	3.9	.083	153R100T1500	154T1500
2"	5.9	.095	153R150T2000	154T2000

"Small Radius" Tube Kit only Part# TUBEKIT1SR

### TB130 with "Large Radius" Tube Kit Part# TB130TLR

Tube Size	CLR	Min. Wall	Center Former Part#	Counterbend Die Part#
¾"	2.6	.035	153R067T0750	154T0750
⅞"	2.6	.035	153R067T0875	154T0875
1"	3.2	.035	153R082T1000	154T1000
1¼"	4.4	.035	153R112T1250	154T1250
1½"	5.9	.049	153R150T1500	154T1500
1¾"	6.7	.065	153R170T1750	154T1750
2"	7.5	.065	153R190T2000	154T2000

"Large Radius" Tube Kit only Part# TUBEKIT1



Part# TB130 machine only

## Reliable Repeatable Bends

### FEATURES

- Ideal for producing consistent quality bends in large pipe, tube, squares, solids and other profiles
- Touch screen control offers easy access to auto and manual operating modes, programming (inch or metric), system diagnostics and multiple language capability
- Quick-change tooling system with multiple radii available
- Digital display of bend angle
- Bend any angle to 180° with independent material springback compensation for each bend
- Foot pedal control of bend and return functions
- Swing away counterbending die vise for easy material handling
- Counterbending die vise position monitored electronically for accuracy and repeatability
- Two axis positioning table for multiple and sequential bends available on special request
- Heavy-duty steel gear case
- No hydraulic components
- Individual tooling available on pages 15-25

## TB130 Capacities & Specifications

Tube (Min.)	1/4"
(Max.)	5"
Pipe (Max.)	4" Sch. 40
Centerline Radius (Min.)	2 x Ø
(Max.)	27 1/2"
Degree of Bend	0-210°
Bending Speed	Variable to .75 RPM
Programming	Touch screen Unlimited storage with USB (12) bends per program
Material Positioning Table	Consult factory
Voltage	220V or 480V 3ph
Length, Width, Height	34" x 34" x 47"
Weight	1,330 lbs.

All capacities based on A53 grade A 48,000 psi tensile materials; heavy wall and high tensile materials reduce machine capacity. Consult supplier for material specifications.

### POPULAR ACCESSORIES



**Tube & Pipe Tooling Kits**



**Spray Lubricant**



**Easy Part Layout Software**



**Roller Counterbending Die**

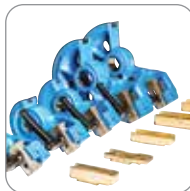

**Large Square Tooling**

**Tooling Kits [Pages 15-16](#)**

**Tooling and Accessories [Pages 17-25](#)**

**Model Comparison Guide [Page 32](#)**



◀ **Ercolina Bending Application**

**Product  
Demonstrations  
Available on Website**

**NEED ADDITIONAL HELP?  
CONTACT ERCOLINA:**

**563.391.7700**

**info@ercolina-usa.com**



# TB180 Top Bender®

## Tube & Pipe Bending Machine



Part# TB180  
machine only



Easy touch screen  
bend angle programming.

## Bending Power For Large Profiles!

### FEATURES

- Ideal for producing consistent quality bends in large pipe, tube, squares, solids and other profiles
- Touch screen control offers easy access to auto and manual operating modes, programming (inch or metric), system diagnostics and multiple language capability
- Quick-change tooling system with multiple radii available
- Digital display of bend angle
- Bend any angle to 180° with independent material springback compensation for each bend
- Hand-held control of bend, return and emergency stop functions
- Hydraulically operated counterbending die vise to control material springback
- Swing away counterbending die vise for easy material handling
- Counterbending die vise position monitored electronically for accuracy and repeatability
- Heavy-duty steel gear case
- Individual tooling available on pages 15-25

## TB180 Capacities & Specifications

Tube (Min.) (Max.)	1½" - 6.7" CLR 6" - .120 wall
Pipe (Min.) (Max.)	1" Sch. 40 - 6.7" CLR 6" Sch. 40
Centerline Radius (Min.) (Max. standard machine) (Max. machine w/case extension)	3 x Ø or 4.5" CLR 23½" 31½"
Degree of Bend	0-210°
Bending Speed	Variable to 1 RPM
Programming	Touch screen Unlimited storage with USB (12) bends per program
Material Positioning Table	Not available
Voltage	480V 3ph
Length, Width, Height	75" x 40" x 59"
Weight	6,000 lbs.

All capacities based on A53 grade A 48,000 psi tensile materials; heavy wall and high tensile materials reduce machine capacity. Consult supplier for material specifications.

### TOOLING

**Pipe and Tube Tooling Available in 3D and 5D Centerline Radius  
Quoted on Request**

**May Require Additional Mounting Component**

Tooling and Accessories Pages [17-23](#)

Model Comparison Guide [Page 32](#)

### POPULAR ACCESSORIES



Roller Counterbending Die



Spray Lubricant



Easy Part Layout Software



◀ Ercolina Bending Application

**Product  
Demonstrations  
Available on Website**

**NEED ADDITIONAL HELP?  
CONTACT ERCOLINA:**

**563.391.7700**

[info@ercolina-usa.com](mailto:info@ercolina-usa.com)

[ercolina-usa.com](http://ercolina-usa.com)



# Bend Formula & Terminology

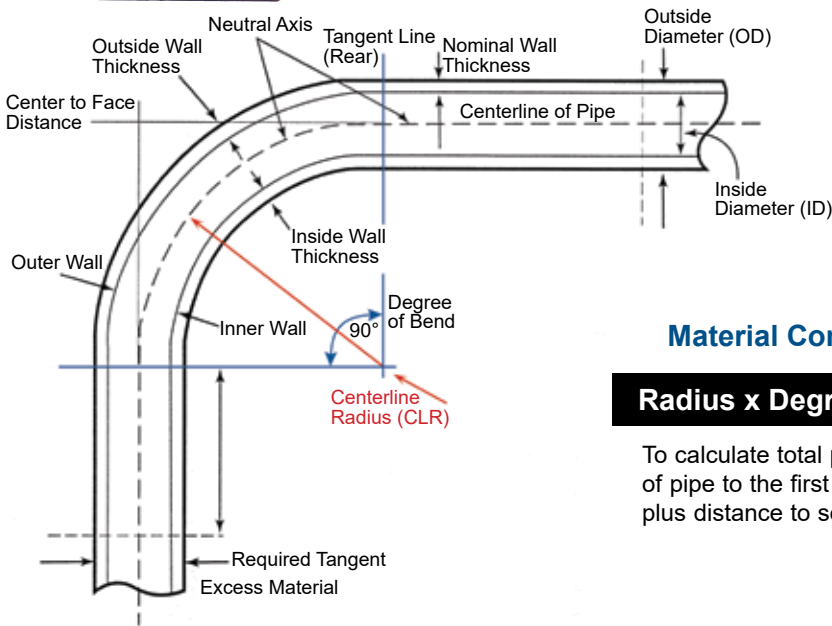

## Material Consumption for Bend Angle

$$\text{Radius} \times \text{Degree of Bend} \times .0175 = \text{Length}$$

To calculate total pipe length, add distance from end of pipe to the first bend, plus first bend arc length, plus distance to second bend.

## Rotary Draw Bend Reference Information

The following information should be used as a guideline only, exact material consumption may vary.

### Material Required for Rotary Draw Bends in Pipe

Angle of Bend	Pipe Size and Centerline Radius					
	1/2"	3/4"	1"	1 1/4"	1 1/2"	2"
	1.8	2.2	2.6	3.5	3.9	5.9
	Material Consumption Guideline					
15	.47	.58	.68	.92	1.0	1.5
30	.97	1.1	1.3	1.8	2.0	3.1
45	1.4	1.7	2.0	2.7	3.0	4.6
60	1.8	2.3	2.7	3.6	4.0	6.2
75	2.3	2.8	3.4	4.5	5.1	7.7
90	2.8	3.4	4.0	5.5	6.1	9.3
120	3.7	4.6	5.4	7.3	8.1	12.4
140	4.4	5.3	6.3	8.5	9.5	14.5
160	5.0	6.1	7.2	9.7	10.8	16.5
180	5.6	6.9	8.1	11.0	12.2	18.6

### Minimum Distance Between Bends for Standard Non-Mandrel Tooling

Former Radius Inches	Former Radius Millimeters	Min. Distance Between Bends
1.8	46	3.1
2.2	56	3.7
2.6	67	3.9
3.2	82	3.9
3.5	90	4.3
3.9	100	4.3
4.1	105	4.3
4.4	112	4.3
4.7	120	5.5
5.1	130	5.5
5.9	145	5.9
6.7	170	5.9
7.5	190	5.9
8.9	225	5.9
10.2	260	6.2
11.8	300	6.2



# Save with Pipe Tooling Kits

(Additional Savings when Purchased with Machine)

Description	Material Size	Centerline Radius - Inches -	Min. Wall	Center Former Part#	Counterbend Die Part#	Available with Ercolina Machines
<b>PIPEKIT1</b>	½"	1.8	.109	153R046P0500	155P0500	<b>TB60</b>
	¾"	2.2	.113	153R056P0750	155P0750	
	1"	2.6	.133	153R067P1000	155P1000	
	1¼"	3.5	.140	153R090P1250	155P1250	
	1½"	3.9	.145	153R100P1500	155P1500	
	2"	5.9	.109	153R150P2000	155P2000	
<b>PIPEKIT2</b>	½"	1.8	.109	153R046P0500	155P0500	<b>SB48</b>
	¾"	2.2	.113	153R056P0750	155P0750	
	1"	2.6	.133	153R067P1000	155P1000	
	1¼"	3.5	.140	153R090P1250	155P1250	
	1½"	3.9	.145	153R100P1500	155P1500	
<b>Handrail Pipe Kit</b>	1¼"	3.5	.140	153R090P1250	155P1250	<b>SB48, TB60 TB80</b>
	1½"	3.9	.145	153R100P1500	155P1500	
<b>PIPEKIT4</b>	1¼"	3.5	.140	153R090P1250	155P1250	<b>TB100, TB130</b>
	1½"	3.9	.145	153R100P1500	155P1500	
	2"	5.9	.109	153R150P2000	155P2000	
	2½"	11.8	.203	157R300P2500-80	155P2500	
	3"	11.8	.216	157R300P3000-80	155P3000	
<b>PIPEKIT6</b>	1"	2.6	.133	153R067P1000	155P1000	<b>TB80</b>
	1¼"	3.5	.140	153R090P1250	155P1250	
	1½"	3.9	.145	153R100P1500	155P1500	
	2"	5.9	.109	153R150P2000	155P2000	
	2½"	10.2	.203	157R260P2500-80	155P2500	

Refer to machine specifications for individual capacities.



# Save with Tube Tooling Kits

(Additional Savings when Purchased with Machine)

Description	Material Size	Centerline Radius - Inches -	Min. Wall	Center Former Part#	Counterbend Die Part#	Available with Ercolina Machines
<b>Small Radius Tube Kit TUBEKIT1SR</b>	¾"	2.6	.035	153R067T0750	155T0750	<b>TB60 TB100, TB130</b>
	⅞"	2.2	.065	153R056T0875	154T0875	
	1"	2.6	.065	153R067T1000	154T1000	
	1¼"	3.2	.083	153R082T1250	154T1250	
	1½"	3.9	.083	153R100T1500	154T1500	
	2"	5.9	.095	153R150T2000	154T2000	
<b>Small Radius Tube Kit TUBEKIT2SR</b>	¾"	2.6	.035	153R067T0750	154T0750	<b>SB48</b>
	⅞"	2.2	.065	153R056T0875	154T0875	
	1"	2.6	.065	153R067T1000	154T1000	
	1¼"	3.2	.083	153R082T1250	154T1250	
	1½"	3.9	.083	153R100T1500	154T1500	
<b>Large Radius Tube Kit TUBEKIT1</b>	¾"	2.6	.035	153R067T0750	154T0750	<b>TB60, TB100, TB130</b>
	⅞"	2.6	.035	153R067T0875	154T0875	
	1"	3.2	.035	153R082T1000	154T1000	
	1¼"	4.4	.035	153R112T1250	154T1250	
	1½"	5.9	.049	153R150T1500	154T1500	
	1¾"	6.7	.065	153R170T1750	154T1750	
	2"	7.5	.065	153R190T2000	154T2000	
<b>Large Radius Tube Kit TUBEKIT2</b>	¾"	2.6	.035	153R067T0750	154T0750	<b>SB48</b>
	⅞"	2.6	.035	153R067T0875	154T0875	
	1"	3.2	.035	153R082T1000	154T1000	
	1¼"	4.4	.035	153R112T1250	154T1250	
	1½"	5.9	.049	153R150T1500	154T1500	
	1¾"	6.7	.065	153R170T1750	154T1750	
<b>Large Radius Tube Kit TUBEKIT5</b>	1"	3.2	.035	153R082T1000	154T1000	<b>TB80</b>
	1¼"	4.4	.035	153R112T1250	154T1250	
	1½"	5.9	.049	153R150T1500	154T1500	
	1¾"	6.7	.065	153R170T1750	154T1750	
	2"	7.5	.065	153R190T2000	154T2000	

Refer to machine specifications for individual capacities.

# Pipe Information



Pipe dimensions are based on I.D. of material (2" sch. 40 pipe measures 2.375" O.D.).

Nominal Size	O.D.	Commercial Pipe and Wall Thickness						XX Strong
		← Schedule →						
		5	10	40	80	160		
1/4"	.540		.065	.088	.119			
3/8"	.675		.065	.091	.126			
1/2"	.840	.065	.083	.109	.147	.188	.294	
3/4"	1.050	.065	.083	.113	.154	.219	.308	
1"	1.315	.065	.109	.133	.179	.250	.358	
1 1/4"	1.660	.065	.109	.140	.191	.250	.382	
1 1/2"	1.900	.065	.109	.145	.200	.281	.400	
2"	2.375	.065	.109	.154	.218	.343	.436	
2 1/2"	2.875	.083	.120	.203	.276	.375	.552	
3"	3.500	.083	.120	.216	.300	.438	.600	
3 1/2"	4.000	.083	.120	.226	.318		.636	
4"	4.500	.083	.120	.237	.337	.531	.674	

## Steel & Polymer Pipe Counterbending Dies

### STEEL

Pipe Size	Outside Diameter	Counterbend Die Part#
3/8"	.675	155AP0375
1/2"	.840	155AP0500
3/4"	1.050	155AP0750
1"	1.315	155AP1000
1 1/4"	1.660	155AP1250
1 1/2"	1.900	155AP1500
2"	2.375	155AP2000

Steel used for heavy wall or abrasive application.

Consult factory for tooling sizes not shown.

### STEEL SUPPORT WITH REPLACEABLE POLYMER INSERT

Pipe Size	Outside Diameter	Counterbend Die Part#
1"	1.315	155SP1000
1 1/4"	1.660	155SP1250
1 1/2"	1.900	155SP1500
2"	2.375	155SP2000

Polymer recommended for materials with a polished finish such as stainless and aluminum.



### REPLACEABLE POLYMER INSERTS

1"	1.315	155SP1000INS
1 1/4"	1.660	155SP1250INS
1 1/2"	1.900	155SP1500INS
2"	2.375	155SP2000INS



# Tooling for Pipe

Pipe Size	Outside Diameter	Wall Thickness Sch. / Inch	Min. CLR Inch	Drive Diameter	Center Former Part#	Counterbend Die Part#
1/4"	.540	40 - .088	1.4	40mm	153R036P0250	155P0250
3/8"	.675	40 - .091	1.4		153R036P0375	155P0375
		10 - .065	2.2		153R056P0375	
1/2"	.840	40 - .109	1.8		153R046P0500 ●	155P0500
		10 - .083	2.2		153R056P0500	
		5 - .065	2.6		153R067P0500	
		5 - .065	4.4		156R112P0500	
3/4"	1.050	40 - .113	2.2		153R056P0750 ●	155P0750
		10 - .083	2.6		153R067P0750	
		5 - .065	3.2		153R082P0750	
		5 - .065	5.1	50mm 156R130P0750		
1"	1.315	40 - .133	2.6	40mm 153R067P1000 ●	155P1000	
		10 - .109	3.2	40mm 153R082P1000		
		10 - .109	3.9	50mm 156R100P1000		
		5 - .065	4.4	40mm 153R112P1000		
		5 - .065	6.7	50mm 156R170P1000		
		5 - .065	6.7	110mm 157R170P1000-110		
1 1/4"	1.660	40 - .140	3.5	50mm	153R090P1250 ●	155P1250
		40 - .140	3.9		153R100P1250	
		10 - .109	5.1		153R130P1250	
		5 - .065	5.9		153R150P1250	
		5 - .065	7.5		153R190P1250	
		5 - .065	8.9		157R225P1250	
		5 - .065	8.9		110mm 157R225P1250-110	
1 1/2"	1.900	40 - .145	3.9	50mm	153R100P1500 ●	155P1500
		40 - .145	5.1		153R130P1500	
		40 - .145	5.9		153R150P1500	
		10 - .109	6.7		153R170P1500	
		5 - .065	7.5		153R190P1500	
		5 - .065	9.8		157R250P1500	
		5 - .065	9.8		110mm 157R250P1500-110	

# Tooling for Pipe

- Continued from previous page -

Pipe Size	Outside Diameter	Wall Thickness Sch. / Inch	Min. CLR Inch	Drive Diameter	Center Former Part#	Counterbend Die Part#
2"	2.375	40 - .154	5.1	50mm	153R130P2000	155P2000
		10 - .109	5.9		153R150P2000 ●	
		5 - .065	7.5		153R190P2000	
		5 - .065	8.9		157R225P2000	
		5 - .065	10.2		157R260P2000	
		5 - .065	10.2	80mm	157R260P2000-80	
		5 - .065	11.8	50mm	157R300P2000	
		5 - .065	11.8	80mm	157R300P2000-80	
		5 - .065	11.8	110mm	157R300P2000-110	
2½"	2.875	40 - .203	10.2	80mm	157R260P2500-80	155P2500
		40 - .203	11.8		157R300P2500-80	
		40 - .203	11.8	110mm	157R300P2500-110	
		10 - .120	13.8	80mm	157R350P2500-80	
		10 - .120	13.8	110mm	157R350P2500-110	
3"	3.500	40 - .216	11.8	80mm	157R300P3000-80	155P3000
		40 - .216	11.8	110mm	157R300P3000-110	
		40 - .216	13.8	80mm	157R350P3000-80	
		10 - .120	17.7	110mm	157R450P3000-110	
4"	4.500	40 - .237	13.8	110mm	157R350P400-110	152BP4000
		10 - .120	22.0	110mm	157R560P400-110**	
6"	6.625	40 - .280	23.2	130mm	157R590P6000-130	152BP6000
		10 - .134	31.5	130mm	157R800P6000-130**	



3D Tooling



5D Tooling



Included in standard Pipe Tooling Kits (pg. 15)

**80mm drive diameter available for TB80 / TB100 / TB130**

**110mm drive diameter available for TB130 / TB180**

**130mm drive diameter available for TB180 only**

**Bending of non-ferrous material may require tooling modification.**

\*Select models require counterbending die support 050E when bending radii 225mm and larger.  
Refer to machine manual for CLR capacities and drive.

All standard Ercolina® counterbending dies are provided in bronze.

\*\*Center Former Part# 157R560P400-110 and 157R800P6000-130 require lead time.



# Tooling for Round Tube

Tube Size	Outside Diameter	Wall Thickness	Minimum CLR Inch	Drive Diameter	Center Former Part#	Counterbend Die Part#
¼"	.250	.035	1.4	40mm	153R036T0250	154T0250
⅜"	.375	.035	1.4		153R036T0375	154T0375
½"	.500	.035	1.4		153R036T0500	154T0500
⅝"	.625	.083	1.4		153R036T0625	154T0625
		.035	1.8		153R046T0625	
¾"	.750	.083	1.8		153R046T0750	154T0750
		.065	2.2		153R056T0750	
		.035	2.6		153R067T0750 ● ●	
⅞"	.875	.083	1.8		153R046T0875	154T0875
		.065	2.2		153R056T0875 ●	
		.035	2.6		153R067T0875 ●	
1"	1.000	.083	2.2		153R056T1000	154T1000
		.065	2.6		153R067T1000 ●	
		.035	3.2		153R082T1000 ●	
1⅛"	1.125	.095	2.2		153R056T1125	154T1125
		.083	2.6		153R067T1125	
		.035	3.2		153R082T1125	
1¼"	1.250	.095	2.6		153R067T1250	154T1250
		.083	3.2	153R082T1250 ●		
		.035	4.4	153R112T1250 ●		
1⅜"	1.375	.083	3.2	153R082T1375	154T1375	
		.035	4.4	153R112T1375		
1½"	1.500	.109	3.5	153R090T1500	154T1500	
		.083	3.9	153R100T1500 ●		
		.083	4.4	156R112T1500		
1½"	1.500	.065	5.1	153R130T1500	154T1500	
		.049	5.9	153R150T1500 ●		
		.035	6.7	156R170T1500		
		.035	7.5	153R190T1500		
1⅝"	1.625	.109	3.5	153R090T1625	154T1625	
		.083	3.9	153R100T1625		
		.065	5.1	153R130T1625		
		.049	5.9	153R150T1625		
		.035	6.7	153R170T1625		
		.035	7.5	153R190T1625		
1¾"	1.750	.109	3.9	153R100T1750	154T1750	
		.095	5.1	153R130T1750		
		.095	5.9	153R150T1750		
		.065	6.7	153R170T1750 ●		
		.035	7.5	156R190T1750		

- Continued on next page -

# Tooling for Round Tube

- Continued from previous page -

Tube Size	Outside Diameter	Wall Thickness	Minimum CLR Inch	Drive Diameter	Center Former Part#	Counterbend Die Part#
1 7/8"	1.875	.109	3.9	50mm	153R100T1875	154T1875
		.095	5.1		153R130T1875	
		.083	5.9		156R150T1875	
		.065	6.7		153R170T1875	
		.035	7.5		153R190T1875	
2"	2.000	.109	4.7		153R120T2000	154T2000
		.109	5.1		156R130T2000	
		.095	5.9		153R150T2000 ●	
		.083	6.7		156R170T2000	
		.065	7.5		153R190T2000 ●	
2 1/8"	2.125	.134	4.7		153R120T2125	154T2125
		.109	5.1		153R130T2125	
		.083	5.9		153R150T2125	
		.083	6.7		156R170T2125	
		.065	7.5		153R190T2125	
2 1/4"	2.250	.109	5.1	153R130T2250	154T2250	
		.095	5.9	153R150T2250		
		.083	6.7	156R170T2250		
		.083	7.5	153R190T2250		
2 3/8"	2.375	.109	5.1	153R130T2375	154T2375	
		.095	5.9	153R150T2375		
		.083	6.7	156R170T2375		
		.083	7.5	153R190T2375		
2 1/2"	2.500	.083	8.9	157R225T2500*	154T2500	
		.083	9.8	157R250T2500*		
		.065	10.2	157R260T2500*		
		.065	11.8	157R300T2500*		
3"	3.000	.156	9.8	157R250T3000*	154T3000	
		.156	10.2	157R260T3000*		
		.120	11.8	157R300T3000*		
3"	3.000	.216	10.2	157R260T3000-80	154T3000	
		.156	11.8	157R300T3000-80		
3 1/4"	3.250	.216	11.8	157R300T3250-80	154BT3250	
		3 1/2"	3.500	.216	11.8	157R300P3000-80
.216	13.8			157R350P3000-80		
4"	4.000	.216	13.8	110mm	157R350T4000-11	155BT4000

● Included in standard small radius Tube Tooling Kits (pg. 16)

● Included in standard large radius Tube Tooling Kits (pg. 16)

80mm drive diameter available for TB80 / TB100 / TB130

110mm drive diameter available for TB130 / TB180 – 130mm drive diameter available for TB180 only

Bending of non-ferrous material may require tooling modification.

\*Select models require counterbending die support 050E when bending radii 225mm and larger.

Refer to machine manual for CLR capacities and drive.

All standard Ercolina® counterbending dies are provided in bronze.



# Round Tube Information

## Minimum Achievable "Centerline Radius" with Standard Tooling

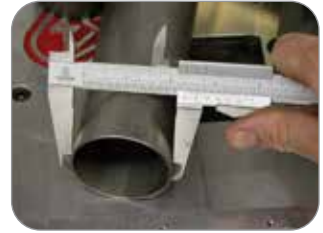

Tube dimensions are based on O.D. of material (2" tube measures 2.00" O.D.).

Tube Size	Wall Thickness							
	.035 20 Ga.	.049 18 Ga.	.065 16 Ga.	.083 14 Ga.	.095 13 Ga.	.109 12 Ga.	.120 11 Ga.	.134 10 Ga.
¼"	1.4	1.4	1.4	1.4	1.4	1.4	.78	.78
⅜"	1.4	1.4	.78	.78	.78	.78	.78	.78
½"	1.4	1.4	1	1	1	1	1	1
⅝"	1.8	1.8	1.8	1.4	1.4	1.4	1.4	1.4
¾"	2.6	2.6	2.6	1.8	1.8	1.8	1.8	1.8
7⁄8"	2.6	2.6	2.2	1.8	1.8	1.8	1.8	1.8
1"	3.2	3.2	2.6	2.2	2.2	2.2	2.2	2.2
1⅛"	3.2	3.2	3.2	2.6	2.2	2.2	2.2	2.2
1¼"	4.4	4.4	4.4	3.2	2.6	2.6	2.6	2.6
1⅜"	4.4	4.4	4.4	3.2	3.2	3.2	3.2	3.2
1½"	7.5	5.9	5.1	3.9	3.9	3.5	3.5	3.5
1⅝"	7.5	5.9	5.1	3.9	3.9	3.5	3.5	3.5
1¾"			6.7	6.7	5.1	3.9	3.9	3.9
1⅞"			7.5	5.9	5.1	3.9	3.9	3.9
2"			7.5	7.5	5.9	4.7	4.7	4.7
2⅛"			7.5	7.5	5.9	5.1	5.1	4.7
2¼"				7.5	5.9	5.1	5.1	5.1
2⅜"				7.5	5.9	5.1	5.1	5.1
2½"					11.8	10.2	9.8	
3"					11.8	10.2	9.8	

All standard Ercolina counterbending dies are provided in bronze.

\*Polished tooling for round tube recommended for materials with a polished finish such as stainless and aluminum.

Optional polymer counterbending dies available on request. Consult factory for more information.

## Steel & Polymer Tube Counterbending Dies

### STEEL

Tube Size	Outside Diameter	Counterbend Die Part#
¾"	.750	154AT0750
7⁄8"	.875	154AT0875
1"	1.000	154AT1000
1¼"	1.250	154AT1250
1⅜"	1.375	154AT1375
1½"	1.500	154AT1500
1¾"	1.750	154AT1750
1⅞"	1.875	154AT1875
2"	2.000	154AT2000
2¼"	2.250	154AT2250
2½"	2.500	154AT2500

Steel used for heavy wall or abrasive application.

Consult factory for tooling sizes not shown.

### STEEL SUPPORT WITH REPLACEABLE POLYMER INSERT

Tube Size	Outside Diameter	Counterbend Die Part#
1⅜"	1.375	154ST1375
1½"	1.500	154ST1500
1¾"	1.750	154ST1750
1⅞"	1.875	154ST1875
2"	2.000	154ST2000

Polymer recommended for materials with a polished finish such as stainless and aluminum.



### REPLACEABLE POLYMER INSERT

1⅜"	1.375	154ST1375INS
1½"	1.500	154ST1500INS
1¾"	1.750	154ST1750INS
1⅞"	1.875	154ST1875INS
2"	2.000	154ST2000INS



## Rotary Draw Accessories

### Spray Bending Lubricant



Part# **810**  
One (1) 12 oz. can

Part# **811**  
Case of Nine (9) 12 oz. cans



### Tie Bar Accessory

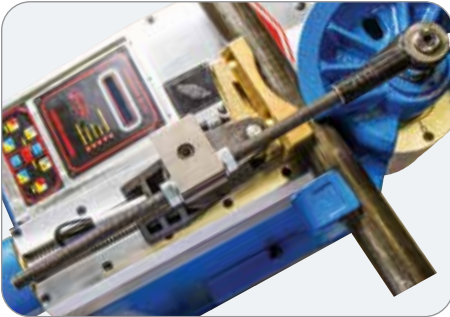

Part# **030TIEBAR**

For use on 030 Mega Bender, TB60, SB48 and 48 Plus.

Tie bar accessory should always be used when bending heavy wall profiles and solid materials.

### Center Former Reinforcement Kit



Part# **REINFKIT**

Available and interchangeable for all round tube or pipe center formers up to 7.5" radius (R190).

Increases the rigidity of standard rotary draw tooling. Recommended for use when bending heavy wall material or solid bar stock.

### Roller Counterbending Dies



Part# **050I** from  $\frac{3}{8}$ " to  $2\frac{3}{8}$ "

Part# **050J** from  $2\frac{1}{2}$ " to 3"

**MUST SPECIFY MATERIAL DIAMETER WHEN ORDERING**

Available for round and square profiles, roller dies are recommended when bending high tensile materials, solids and heavy wall profiles.

Note: Roller dies must be positioned a minimum of  $2\frac{1}{2}$ " from face of center former; failure to do so will cause machine damage. Not suitable for bends beyond 130°.

### Counterbending Die Adapter Plate



Part# **CBDAP**

High quality, machined, aluminum bracket used to interchange between cam lock and drop in style counterbending dies.

### Counterbending Die Support



Part# **050E**  
(replaces standard vise)

Required when bending radii 225mm and larger.  
(Not required for TB80/TB100/TB130/TB180.)



# Tooling for Square Tube

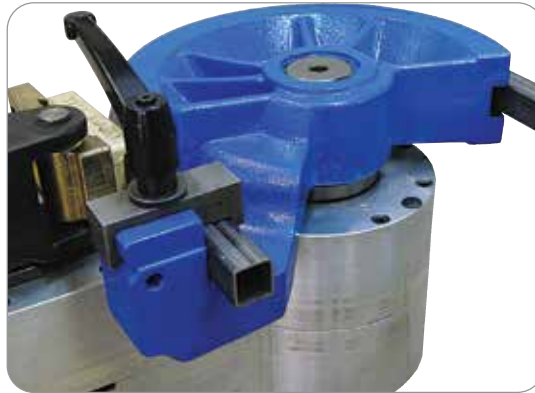

Tube Size	Outside Diameter	Wall Thickness	Minimum CLR Inch	Drive Diameter	Center Former Part#	Counterbend Die Part#
1/2"	.500	.065	1.4	40mm	1582AR0360500	1591A0500
		.049	1.8		1582AR0460500	
3/4"	.750	.120	1.8		1582AR0460750	1591A0750
		.065	2.6		1583AR0670750	
1"	1.000	.120	3.0		1583AR0761000	1591A1000
1"	1.000	.083	3.9		50mm	1585AR1001000
		.065	5.1	1587AR1301000		
		.049	5.9	1588AR1501000		
1 1/4"	1.250	.120	5.1	1587AR1301250		1591A1250
		.095	6.6	1589AR1701250		
1 1/2"	1.500	.120	5.9	1588AR1501500		1591A1500
		.095	7.4	15810AR1901500		
2"	2.000	.120	5.9	1588AR1502000		1591A2000
		.095	7.4	15810AR1902000		
2 1/2"	2.500	.125	11.8	15813AR30025-80	1591A2500	
3"	3.000	.187	13.8	15814AR35030-80	1591A3000	

**80mm drive diameter available for TB80 / TB100 / TB130  
Consult factory for tooling sizes not shown.**



## Tooling for Square Tube

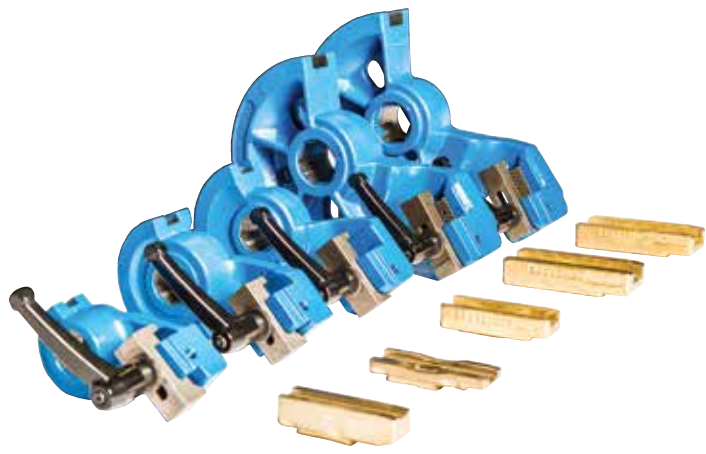

## Square Tube Tooling Kits

Description	Material Size	CLR -Inches-	Min. Wall	Center Former Part#	Counterbend Die Part#	Available with Ercolina Machines
<b>TUBEKITSQ1</b>	½"	1.8	.049	1582AR0460500	1591A0500	<b>SB48, TB60 TB80, TB100 TB130</b>
	¾"	2.6	.065	1583AR0670750	1591A0750	
	1"	3.0	.120	1583AR0761000	1591A1000	
	1¼"	5.1	.120	1587AR1301250	1591A1250	
	1½"	5.9	.120	1588AR1501500	1591A1500	
<b>TUBEKITSQ2</b>	½"	1.8	.049	1582AR0460500	1591A0500	<b>TB60, TB80 TB100, TB130</b>
	¾"	2.6	.065	1583AR0670750	1591A0750	
	1"	3.0	.120	1583AR0761000	1591A1000	
	1¼"	5.1	.120	1587AR1301250	1591A1250	
	1½"	5.9	.120	1588AR1501500	1591A1500	
	2"	5.9	.120	1588AR1502000	1591A2000	

## Material Extraction Device for Square Tube

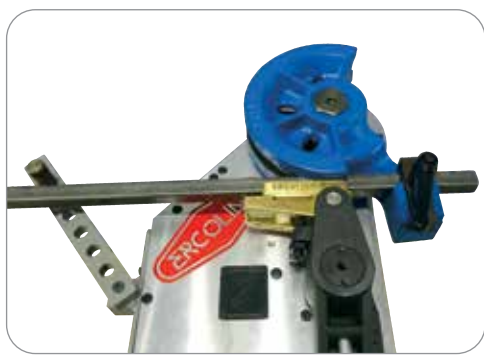

Part# **FP500P1-A**

Extractor plate assists in square material extraction for profiles, solid and hollow.

For use on 030 Mega Bender, TB60, SB48 and 48 Plus models.



# A40/P Two Axis Positioner

Ideal for repetitive parts  
and left & right mirror images

Part# **A40-P**  
Accommodates parts  
to 10' length



## Capacities & Specifications

Height	43"
Length	110"
Width	32"
Material Capacity Through Spindle (Max.)	1/2" – 2-3/8"
Chuck Rotation	1" O.D. 360°
Weight	180 lbs.

**Consistency  
Repeatability  
Increased Profitability**

### FEATURES

- Manually controls accurate linear (Y) advancement and rotational (B) plane of bend
- Reduces operating handling and labor costs
- Helps eliminate unnecessary material scrap
- Previous layout and design experience not required
- Adapts to Ercolina 030 Mega Bender, TB60, SB48 and 48 Plus machines
- Pneumatic work holding chuck secures material and rotates 0-360°
- Chuck activation valve conveniently positioned near operator and machine controls
- Includes: four (4) sets of chuck jaws for material 1/2" to 2 3/8", six (6) adjustable linear and rotary stops
- Optional digital readout of linear and rotational bends
- Custom length tables available on request

Note: **Positioner not intended for solid profiles**

**Quickly layout and produce drawings for bending applications!**

**Ideal for use with A40-P two axis positioner.**



Part# **BENSW-SUPER**

## Reduce layout cost

### FEATURES

- Eliminate unnecessary material scrap
- Previous layout and design experience not required
- Mouse pick points allow dimension placement
- Dimension with decimals or fractions
- Save part program files for later use
- Information material data base included
- CLR or inside radius (adjustable for each bend)
- Create printable dimensioned model, shaded model, flat layout & title block
- Flat layout of cut length & bending locations
- Can be dimensioned from start of bend, end of bend & center of bend, or either direction
- Provides springback bend angle
- Print includes bending data such as bend angles, CLR or inside radius, rotation angle & bend order
- Preferences: color, text size & arrow size are saved in user definable data bases
- Verifies sufficient material is available for bending process
- Extra checking tools provided to verify part validity
- Allows multiple dies to be used on the same part
- Graphical layout interface provided
- Advanced LRA "Length, Rotation & Angle" design interface
- Powerful reverse engineering feature
- Inch to metric conversion
- CD-ROM Windows XP or higher required
- All standard Ercolina tooling included in tooling library
- LRA: transfers any part into XYZ data when entering LRA information into Custom Part interface; XYZ data available
- Railing Templates: includes hand railing template
- Chord measuring tool for large radius bending
- File Import/Export
- Estimating: Helps define project cost

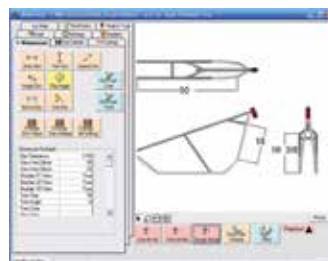

**Assembly Drawing**

**XYZ**

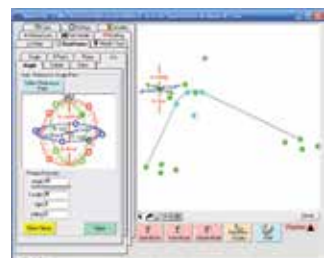



# Handrail Simulation Samples

## Wall Rail

**Material:** 1¼" Schedule 40  
**Tooling:** 1.660 Pipe R90  
**CLR:** 3.5  
**Cal. CLR:** 3.550  
**Cut Off Start End:** 5.25  
**Cut Off Far End:** 5.25

**Shop Instructions:**

**Cut Length:** 132 5/16

A	B	Location	Rotation	Angle	CLR
1	1	4 1/4	0	90	3.5
2	2	17 3/16	(-90)	32	3.5
		Flip			
4	3	128 1/16	(-90)	90	3.5
3	4	115 1/16	(-90)	32	3.5

**Design Instructions: Custom Part**

**Cut Length:**

A	Length	Rotation	Angle	Type
1	2.5	0	90	Apex
2	12	-90	32	Apex
3	96	180	32	Apex
4	12	-90	90	Apex
E	2.5			



## Bleacher

**Material:** 1¼" Schedule 40  
**Tooling:** 1.660 Pipe R90  
**CLR:** 3.5  
**Cal. CLR:** 3.550

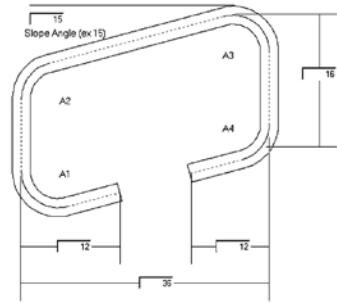

## Handicap Rail

**Material:** 1¼" Schedule 40  
**Tooling:** 1.660 Pipe R90  
**CLR:** 3.5  
**Cal. CLR:** 3.550

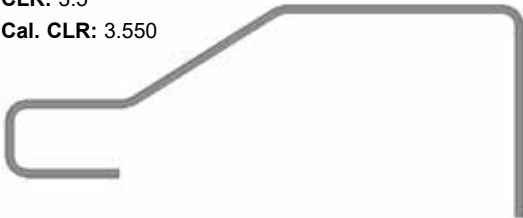

**Shop Instructions:**

**Cut Length:** 181 5/16

A	B	Location	Rotation	Angle	CLR
5	1	18 1/2	0	90	3.5
4	2	31	0	90	3.5
3	3	55 15/16	180	32	3.5
2	4	91 7/8	180	32	3.5
1	5	137 5/16	0	90	3.5

**Design Instructions: Custom Part**

**Cut Length:**

A	Length	Rotation	Angle	Type
1	42	0	90	Apex
2	48	0	32	Apex
3	36	0	-32	Apex
4	24	0	90	Apex
5	14	0	90	Apex
E	22			

Location      Rotation      Bend

Bend Number: 1 Location: 18 1/2 Rotation: 0 Bend Angle: 90			
Bend Number: 2 Location: 31 Rotation: 0 Bend Angle: 90			
Bend Number: 3 Location: 55 15/16 Rotation: 180 Bend Angle: 32			
Bend Number: 4 Location: 91 7/8 Rotation: 180 Bend Angle: 32			
Bend Number: 5 Location: 137 5/16 Rotation: 0 Bend Angle: 90			

# Initial Quotation Information

Date:		
Company Name:		
Contact:		
Position/Title:		
Address:		
Address:		
City:	State:	
Zip/Postal Code:		
Telephone:		
Fax:		
Email:		
Cell/Alternate Phone:		
Website:		

Fill in requested information to help us serve you better.

Call: 563-391-7700

Fax: 563-391-7710

Email: [info@ercolina-usa.com](mailto:info@ercolina-usa.com)

### Origin of Contact

Phone In  
 Internet / Email  
 Dealer Dealer Name:   
 Trade Show / Exhibition Show Name:   
 Referral Referred By:   
 Advertisement Publication:

### Tooling Information

Are product prints available?  Yes  No

Number of bends per part:	<input type="text"/>
Overall developed length of part:	<input type="text"/>
Desired centerline radius:	<input type="text"/>
Minimum distance between bends:	<input type="text"/>
Outside material diameter:	<input type="text"/>
Maximum degree of bend:	<input type="text"/>

Please specify any tolerances to be held on part shape including ovality, wall thinning and cosmetic concerns:

### Application Information

Brief Description of Application:

Is this a new or existing project?

Are you currently making this part or outsourcing?

If you are producing, explain process or equipment utilized:

Anticipated production requirement:

Number of shifts:

How soon will you require a machine?

Do you have financing in place or would you like leasing information?

### Material Information

ASTM material grade:	<input type="text"/>
Outside diameter:	<input type="text"/>
Wall thickness:	<input type="text"/>
Min/Max Tube Length:	<input type="text"/>

### Follow Up Activity

Would you like to schedule a visit with an Ercolina representative?	<input type="radio"/> Yes <input type="radio"/> No
Will you be sending materials to be bent?	<input type="radio"/> Yes <input type="radio"/> No
Would you like to arrange a visit to our factory to view a machine under power?	<input type="radio"/> Yes <input type="radio"/> No

Comments:



# Non-Mandrel Tooling Order Form

Quote: \_\_\_\_\_

Company Name: \_\_\_\_\_ Contact: \_\_\_\_\_ Date: \_\_\_\_\_

Address: \_\_\_\_\_

City: \_\_\_\_\_ State: \_\_\_\_\_ Zip: \_\_\_\_\_

Telephone: \_\_\_\_\_ Fax: \_\_\_\_\_ Email: \_\_\_\_\_

Distributor Name: \_\_\_\_\_ Contact: \_\_\_\_\_

### Material Specifications:

Round Tube/Pipe Dimensions: \_\_\_\_\_ OD \_\_\_\_\_ ID

Square/Rect. Tube/Pipe Dim.: \_\_\_\_\_ OD \_\_\_\_\_ ID

Wall Thickness: \_\_\_\_\_

Material Type/Grade: \_\_\_\_\_

Weld Seam: \_\_\_\_\_ Yes \_\_\_\_\_ No

No. Parts Per Day: \_\_\_\_\_ No. Bends Per Part: \_\_\_\_\_

Prints Supplied: \_\_\_\_\_ Yes \_\_\_\_\_ No

Are Mill Certs Available \_\_\_\_\_ Yes \_\_\_\_\_ No

Centerline Radius (CLR): \_\_\_\_\_

Min. Dist. Bet. Bends (G): \_\_\_\_\_

Outside Diameter (OD): \_\_\_\_\_

Maximum Degree of Bend: \_\_\_\_\_

### Center Former

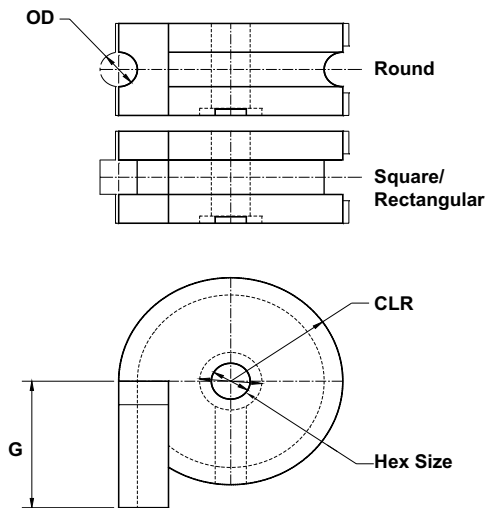

### Machine and Tooling Recommendations: \_\_\_\_\_

\_\_\_\_\_

\_\_\_\_\_

\_\_\_\_\_

\_\_\_\_\_

\_\_\_\_\_

\_\_\_\_\_

\_\_\_\_\_

\_\_\_\_\_

\_\_\_\_\_

\_\_\_\_\_

### Bend Terminology

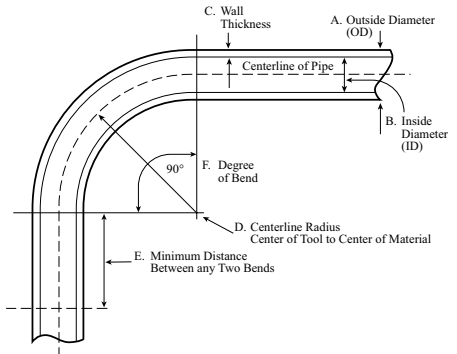

I have reviewed the above information for accuracy and confirm it is correct. Any alterations made from original information will result in additional cost and may extend delivery time.

Customer Signature







Date













## GENERAL PRODUCTION MODELS

Profile Description	SB48	TB60
 Mild Steel Pipe	1½" Sch. 40	2" Sch. 40
 Stainless Steel Pipe	1¼" Sch. 10	1½" Sch. 40
 Mild Steel Square Profile	1½" x 1½" x ⅛"	2" x 2" x ⅛"
 Mild Steel Rectangular Profile (Easy Way)	¾" x 1½" x .120"	1" x 2" x .120"
 Mild Steel Rectangular Profile (Hard Way)	1½" x ¾" x .120"	2" x 1" x .120"
 Mild Steel Solid Rod	1⅝"	1¼"

## HEAVY-DUTY INDUSTRIAL MODELS

Profile Description	TB80	TB100	TB130	TB180
 Mild Steel Pipe	2½" Sch. 40 Grade B	3" Sch. 40	4" Sch. 40	6" Sch. 40
 Stainless Steel Pipe	2½" Sch. 10	2½" Sch. 40	3" Sch. 80	4" Sch. 80
 Mild Steel Square Profile	2½" x 2½" x ⅛"	3½" x 3½" x ⅛"	4" x 4" x ⅛"	4" x 4" x ¼"
 Mild Steel Rectangular Profile (Easy Way)	2" x 3" x .125"	2" x 4" x .187"	2" x 4" x .250"	2" x 4" x .250"
 Mild Steel Rectangular Profile (Hard Way)	3" x 2" x .125"	4" x 2" x .120"	4" x 2" x .187"	4" x 2" x .250"
 Mild Steel Solid Rod	1½"	2"	2½"	3"

All capacities based on A53 grade A 48,000 psi tensile materials; heavy wall and high tensile materials reduce machine capacity. Consult supplier for material specifications.

# NC & CNC MANDREL BENDERS

MANDREL BENDERS





# 030 Mandrel Bender

## Semi-Automatic Rotary Draw Mandrel Bender



Patented hydraulic finger (FST) clamp system minimizes distance between bends.



Tube Capacity



Part# 030-A3/H76  
(10' table displayed)



Operator-friendly control pad. Step-by-step programming with multi-language capability.

## Prototype or Small Production Applications

### FEATURES

- Variable bending speed
- Ideal for bending handrail, thin wall mild steel, stainless steel, bend grade aluminum and other materials
- Programmable bend sequencing and mandrel retraction
- Independent clamp and pressure die adjustment
- Reinforced tool mounting shaft with heavy duty swing arm for maximum rigidity
- Micrometer wiper die adjustment
- Secondary hydraulic pressure die stabilization system
- Quick-change tooling reduces setup time
- Tables available in 5', 10' or 20' lengths; standard with pneumatic material clamping and DRO system for linear and rotational positioning
- Bending software available for part layout guideline
- Base machine converts to accept Ercolina non-mandrel tooling
- Reference display of Y & B axis to assist set-up
- Y - Feeding manual with adjustable stops
- B - Feeding manual with adjustable stops
- C - NC programmable bend angle

## 030 Mandrel Capacities & Specifications

Max. Tube Capacity – Mild Steel	2½" (.083 wall)
Stainless	2½" (.065 wall)
Square Tube	2" (.065 wall)
Max. Pipe Capacity	1½" Sch. 40
Max. Bending Radius	7⅞"
Min. Bending Radius	1.5 x Ø
Max. Shaft Rotation	210°
Max. Bending Angle	180°
Max. Tailstock Capacity	2⅜"
Max. Material Length – 5' table	59"
10' table	118"
20' table	240"
Mandrel Table (available in 5'-10'-20' lengths)	165"
Number of Programs	(30) Standard
Precision of Bend Angle	+/- 1°
Power	Three Phase 220V or 480V
Dimensions (Height x Width x Length)	44" x 32" x 83"-260"
Weight	1,600 lbs.

Contact CML USA for complete technical specifications.

All capacities based on mild grade materials; heavy wall and high tensile materials reduce machine capacity.

### Mega Bender 030 with Mandrel System

Part#	Description
030-A15/H76	Mega Bender 030 with 5' table
030-A3/H76	Mega Bender 030 with 10' table
030-A6/H76	Mega Bender 030 with 20' table
A15/H76	(5') mandrel table only
A3/H76	(10') mandrel table only
A6/H76	(20') mandrel table only



◀ Ercolina Bending Application

**Product  
Demonstrations  
Available on Website**

**NEED ADDITIONAL HELP?  
CONTACT ERCOLINA:**

**563.391.7700**

**info@ercolina-usa.com**



# TB80 Mandrel Bender

Semi-Automatic Rotary Draw Mandrel Bender



Part# TB80-A/P80NC

## Ideal for Prototype or Daily Production

### FEATURES

- Control swings out to offer easy access to manual and auto operating modes, system diagnostics and multiple languages
- Unlimited storage of bend programs, material library and job information (optional)
- Touch screen displays absolute (ABS) or incremental (INC) positioning with inch or metric readout
- Programmable C axis with manual Y and B positioning
- Variable bending speed to 3 RPM with overload protection
- Programmable bend angle 0 to 180°
- Individual material springback and speed settings for every bend angle
- Anticipated mandrel retraction, clamping, pressure die and boost die movements
- Pressure die with auto recapture minimizes distance between bends
- Heavy duty tailstock carriage with segmented collet hydraulic clamping of work piece
- Tailstock Y and B position display resets to zero after each bend for easy setup while maintaining absolute position

## **TB80 Mandrel Capacities & Specifications**

Max. Tube Capacity – Mild Steel	3" (.125 wall)
Stainless	3" (.083 wall)
Square Tube	2½" (.083 wall)
Max. Pipe Capacity	2½" Sch. 10
Max. Bending Radius	11.8"
Min. Bending Radius	1.5 x Ø
Max. Shaft Rotation	210°
Max. Bending Angle	180°
Max. Tailstock Through Capacity	3"
Max. Material Length – standard table	13'
Optional Table Extension	21'
Program Storage	USB Optional
Precision of Bend Angle	+/- 1°
Power	Three Phase 220V or 480V
Dimensions (Height x Width x Length)	61" x 36" x 179" or 251"
Weight (13' or 21' table)	2,000 lbs. or 2,600 lbs.

Contact CML USA for complete technical specifications.

All capacities based on mild grade materials; heavy wall and high tensile materials reduce machine capacity.



Patented finger style (FST) clamping system minimizes clamping area.

- Bending head adjusts horizontally to maintain centerline radius of former allowing table to remain stationary
- Patented finger style (FST) clamping system minimizes distance between bends
- Hand-held remote control certified class three safety
- Direct drive electro-mechanical bending axis
- Precision encoders on all axes for greater repeatability
- Heavy one-piece steel structure improves rigidity and minimizes vibration
- Externally mounted gauges for adjustment of system and clamping pressure
- Accepts standard 030 mandrel tooling
- Electrical components UL, CSA and CE approved
- Programmable internal lubrication available
- Y - Feeding manual with adjustable stops
- B - Feeding manual with adjustable stops
- C - NC programmable bend angle



# ERCOLINA® HANDRAIL FABRICATION SYSTEM

## Ercolina's handrail professional series package includes:

- Erco Bender three axis CNC automatic bending machine
- 1-1/4" pipe schedule 40 set complete
- 1-1/2" pipe schedule 40 set complete
- 1-1/2" tube for .120 wall set complete
- Auto mandrel lubrication pump
- Bendtech software for external computer
- Machine training on-site

- Produce handrail to design in minutes
- Dramatically reduce operator handling and shop labor cost
- Improve quality to your customers providing mandrel quality bends in steel, stainless and aluminum
- Eliminate additional cost of weld elbows, material waste, weld, grind and finish operations
- Control your production time and process
- Quickly store and recall previous handrail programs
- Ercolina's tool set data files maintain machine start position enabling the operator to quickly change to the next job

- Optional software available directly imports properly formatted IGES and Dxf engineering files from compatible CAD programs
- Create your own data with optional Bend-Tech software
- Professional on-site machine training included





# Interactive Touch Screen Control

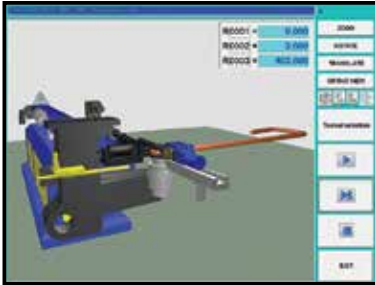

GRAPHIC SIMULATION



PART LAYOUT



TOUCH SCREEN PROGRAMMING



MAIN SCREEN

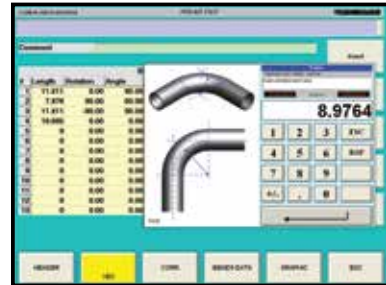

BEND ANGLE & SPRINGBACK



STORE ALL TOOL SET INFORMATION



STORE MATERIAL INFORMATION

## Interactive CNC Control Available on these Models:

- ▶ Erco Bender 65
- ▶ Erco Bender 76
- ▶ GB100 Giga Bender
- ▶ GB130 Giga Bender
- ▶ GB200 Giga Bender



# EB65 & EB76 Erco Bender

## Automatic 3 Axis Mandrel Machines

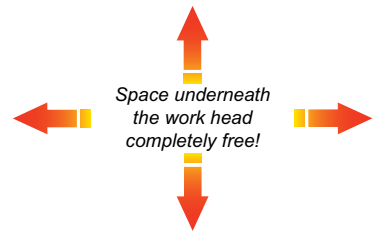

Part# EB76CNC6V5

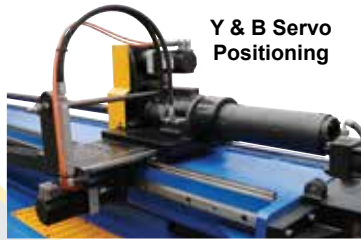

Y & B Servo Positioning



### Fully Automatic – Cost Effective

#### FEATURES

- Extended bending head capable of bending complex shapes and profiles
- Automatic or manual bend sequencing
- Independent pressure and clamp die adjustment
- Programmable carriage movement for tight radii
- Interactive touch screen with auto and manual operating modes, system diagnostics and multiple language capability
- Standard right hand bending direction
- Programmable material springback settings for each bend angle
- Programmable auto mandrel positioning allows operator to optimize extraction for improved bend quality
- Programmable tail stock interference zone monitors position and eliminates workhead collision
- USB for unlimited program memory storage and communication

## **EB65 & EB76 Capacities & Specifications**

<b>Model</b>	<b>EB65</b>	<b>EB76</b>
Max. Tube Capacity – Mild Steel	2½" (.083 wall)	3" (.083 wall)
Stainless	2½" (.065 wall)	3" (.065 wall)
Square Tube		2" (.065 wall)
Max. Pipe Capacity	1½" Sch. 40	2" Sch. 40
Max. Bending Radius	9.8"	9.8"
Min. Bending Radius	1.5 x Ø	1.5 x Ø
Max. Shaft Rotation	210°	210°
Max. Bending Angle	185°	185°
Max. Tailstock Capacity	2½"	3"
Interactive Touch Screen Control	10" color screen	10" color screen
Max. Material Length – Standard table	13'	13'
Optional Table Extension	21'	21'
Minimum Underhead Swing Clearance	14.5"	15.5"
Length of Bending Head	59"	59"
Maximum Carriage Travel	125"	125"
Number of Programs	Unlimited	Unlimited
Precision of Bend Angle	+/- .5°	+/- .5°
Power	Three Phase 480V	Three Phase 480V
Dimensions (Height x Width x Length)	52" x 44" x 205"	52" x 44" x 205"
Weight	7,200 lbs.	7,400 lbs.

Contact CML USA for complete technical specifications.

All capacities based on mild grade materials; heavy wall and high tensile materials reduce machine capacity.

- Hand-held remote bending control, certified class 3 safety and all electrical components UL, CSA and CE approved
- Graphic bend simulation software included
- Programmable internal mandrel lubrication (3 settings)
- High capacity with auxiliary hydraulic oil cooling
- Quick-change tooling system
- Standard 13' table, extension available
- Tail stock with through spindle accepts longer material
- Accepts YBC and XYZ input values
- Y - Feeding Electric Servo
- B - Rotation Electric Servo
- C - Bending Hydraulic CNC



# GB100SCNC Giga Bender

CNC Mandrel Machine



## Heavy Steel Structure Provides Rigid Platform and Minimizes Vibration

### FEATURES

- GB100SCNC control of 7 axis with Windows controller
- Ideal for industrial mandrel bending of tube, pipe, square and rectangular profiles to center line radius as small as 1.5D
- Programmable bend angles with independent material springback setting for each bend
- Programmable auto mandrel positioning allows operator to optimize extraction for improved bend quality
- Adjustable clamping, pressure die and boost movements with manual override
- Digital encoders on each axis
- Programmable tail stock interference zone monitors position and avoids workhead collision
- Large capacity hydraulic reservoir with automatic cooling system
- Standard hydraulic ports accept Ercolina patented (KST) clam shell clamp system

## GB100SCNC Capacities & Specifications

<b>Giga Bender Model</b>	<b>GB100SCNCV2 (CNC)</b>
Max. Tube Capacity – Mild Steel	4 <sup>3</sup> / <sub>4</sub> " (.187 wall) <i>KST std.</i>
Stainless	4 <sup>3</sup> / <sub>4</sub> " (.187 wall) <i>KST std.</i>
Square Tube	4" (.125 wall) <i>KST std.</i>
Max. Pipe Capacity – A36	3" Sch. 40
Max. Bending Radius	16"
Min. Bending Radius	1.5 x Ø
Max. Material Length – Standard table	13'
Hydraulic Clamping	(KST) Clam Shell
(C Axis) Rotation / Bend Angle	CCW / 0° to 180°
(B Axis) Bend Plane Rotation (Y1 Axis) Distance Between Bends	Auto positioning with digital display
(X2) Pressure Die Linear Travel (Y2) Pressure Die In-feed	Programmable with digital readout
Program Storage	Unlimited with USB
Hydraulic Reservoir	40 gal.
Motor (horse power @ 480V)	30
Power	Three Phase 480V
Dimensions (Height x Width x Length)	55" x 51" x 298"
Weight (Dry)	7,200 lbs.

Contact CML USA for complete technical specifications.

All capacities based on mild grade materials;  
heavy wall and high tensile materials reduce machine capacity.

- Hand-held remote bending control, certified class 3 safety electrical components UL, CSA and CE approved
- Standard programmable internal mandrel lubrication
- Super Bend-Tech SE for Ercolina software included
- Accepts YBC and XYZ input values
- Y - Auto Feeding Hydraulic (CNC only)
- B - Auto Feeding Hydraulic (CNC only)
- C - Bending Hydraulic (NC or CNC)



## GB130/GB200 Giga Bender

Fully Automated CNC Mandrel Machines



### Heavy Steel Structure Provides Rigid Platform and Minimizes Vibration

#### FEATURES

- Interactive PLC touch screen offers easy access to auto and manual operating modes, system diagnostics and multiple language capability
- Programmable bend angles with independent material springback setting for each bend
- Programmable auto mandrel positioning allows operator to optimize extraction for improved bend quality
- Programmable clamping, pressure die and boost movements with manual override
- Precision encoders on each axis
- Programmable tail stock interference zone monitors position and eliminates workhead collision
- High capacity hydraulic reservoir with automatic cooling system
- Hand-held remote bending control, certified class 3 safety and all electrical components UL, CSA and CE approved

## GB130/GB200 Capacities & Specifications

<b>Model</b>	<b>Giga Bender 130</b>	<b>Giga Bender 200</b>
Max. Tube Capacity – Mild Steel	5" (.196 wall)	6½" (.187 wall)
Stainless	5" (.150 wall)	6" (.187 wall)
Square Tube	4" (.160 wall)	4" (.187 wall)
Max. Pipe Capacity	4" Sch. 40	6" Sch. 40
Max. Bending Radius	18"	20"
Min. Bending Radius	3.125"	4.7"
Max. Tube Inside Carriage	5"	6½"
Max. Length Through Carriage	236"	236"
Max. Length in Carriage	177"	177"
Interactive Control	10" touch screen color	10" touch screen color
Number of Programs	Unlimited w/USB	Unlimited w/USB
Bend Direction	CCW	CCW
"Y" Axis Speed (ft/min)	164	118
"B" Rotation Speed (RPM)	30	20
"C" Bend Speed (RPM)	2	.6
Repeatability "Y" Axis	± .2mm	± .2mm
"C" Axis	± .5mm	± .5mm
Power	Three Phase 480V	Three Phase 480V
Dimensions (Height x Width x Length)	71" x 75" x 319"	77" x 91" x 339"
Weight (Dry)	18,000 lbs.	30,000 lbs.

Contact CML USA for complete technical specifications.

All capacities based on mild grade materials; heavy wall and high tensile materials reduce machine capacity.

- Standard programmable internal mandrel lubrication
- Machine frame standard compression design
- Super Bend-Tech SE for Ercolina software included
- Accepts YBC and XYZ input values
- Y - Feeding Hydraulic
- B - Feeding Hydraulic
- C - Bending Hydraulic CNC



# Giga Bender Features for Bending Heavy Tube and Profiles

### **Bend Head**

New patented bending head concept travels horizontally to adjust for bending radius. GB series bending head is manufactured from GS 500 spheroidal cast iron to absorb vibrations during the bend cycle providing maximum stability with high torque.

### **Clamp System**

Clamp integrates to the top of bend die allowing more space to position the tube while providing optimal clamp pressure. Safely eliminates swing arm movement, reduces flexing and minimizes tooling setup and change over.

### **Booster Function**

Booster function pushes the tube into bending die to minimize tube thinning in the extrados and prevent movement in clamp. Booster with adjustable speed features recapture function for deep angles ensuring the booster pressure throughout the bend length. Boost position monitored with digital encoder and is adjustable through programming eliminated manual adjustments.

### **Tailstock Carriage**

Tailstock features large pass enabling control to program recapture of longer tube as necessary for the customer application. Segmented collets clamp securely with dual hydraulic cylinders. Y-axis with radial slide moves during the bend cycle accommodating radial growth and reduces pressure on linear axis.

### **Machine Structure**

Ercolina GB series have a patented machine frame system working in flexion providing increased stability and accuracy with reduced weight. The tube axis positioned inside machine structure unlike conventional bending machines, which use weight to compensate for design.

### **Mandrel Retract System**

Mandrel position is controlled with encoder and adjustable with software, eliminating manual positioning. Program features anticipated mandrel retraction and positioning for better bend quality. Mandrel rod installed or removed with easy release locking pin for faster tooling change. Mandrel rod can be stationary or can rotate as required.



Giga Bender Line

MANDREL BENDERS





# Mandrel Tooling Information

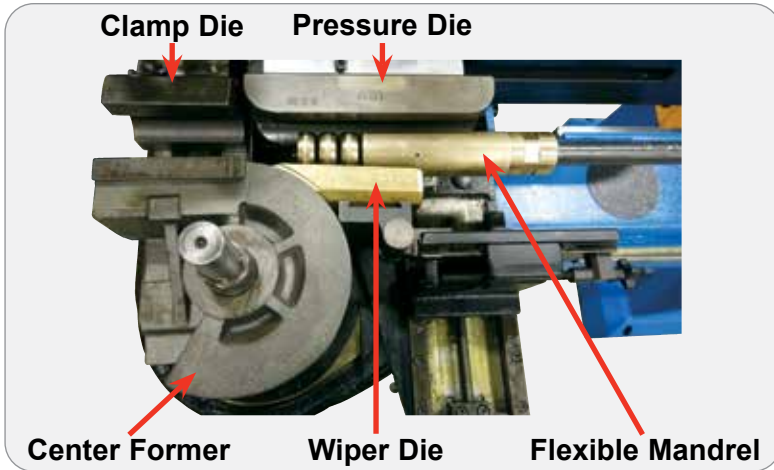

Ercolina mandrel systems incorporate five (5) individual tooling components to effectively support the profile during bending process. These components; **Center former, pressure die, clamp die, wiper die and flexible mandrel** are specific to material type and dimension.

### The following must be supplied when ordering mandrel tooling:

- Profile shape
- Interior and exterior dimensions
- Wall thickness
- Material type
- Minimum distance between bends
- Number of bends per day required

It is highly recommended dimensional drawings of finished product be supplied with mandrel tooling orders.

All mandrel tooling is special order and requires **non refundable** advanced payment.

## When is a Mandrel Necessary?

When a tube is bent the outside wall collapses and thins out, and the inside compresses. When bending thin wall tube to tight radius a mandrel and wiper die are necessary. Use of a mandrel minimizes the amount of ovality occurring during bending.

### COMPONENTS OF MANDREL BENDING

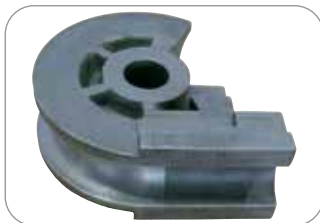

**Center Former / Bend Die:** The primary tool which determines bend radius. Manufactured from tool steel or alloy steel and heat treated depending on requirements. Clamp face is serrated to assist grip strength.

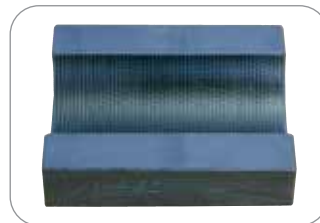

**Clamp Die:** Matches center former clamp surface. The clamp die's primary function is to hold tube securely to the center former.



**Pressure Die:** Maintains constant pressure on tube at tangent where the bend occurs, providing reactionary force to make the bend. Length of the pressure die depends on the degree of bend (DOB) of part being bent and the machine design.



**Wiper Die:** Manufactured to match center former radius. Mounts into the groove of the center former with tip positioned near tangent point of bend. Primary function is to prevent wrinkling on the inside radius of the tube. Wiper dies are typically manufactured from AMPCO® bronze.



**Mandrels:** Generally made from the same material as the wiper die. Primary function of the mandrel is to prevent inside diameter of the tube from collapsing. Choosing the correct mandrel is very important in determining the quality of bend. Three basic styles of mandrels are:

1. **Plug mandrel** used for heavier walled tube or large CLR bending.
2. **Standard open pitch mandrel** is most widely used because it covers the widest range of bending applications. Standard mandrels are made with one to three balls. Open pitch mandrel is the most durable of the three

flexible mandrel configurations because it uses the largest size links possible.

3. **Thin wall mandrel (close pitch mandrel)** used mostly for thin wall tubing. Thin wall style mandrels use the same style linkage as standard mandrels except the link size is the next size smaller than it would be on a standard mandrel. For example, where a standard style mandrel would use a #10 size link, a thin wall style mandrel would use a #9 size link. The ball segments are now closer together and provide more support needed for thin walled tube bending. Strength is sacrificed for more support.



**Collet:** The collet is mounted in the tailstock of machine and holds material securely in carriage. Collets are size-specific and must match the tooling mounted on machine.

**Lubrication:** Comes in several different forms such as oil, grease, and paste. The kind of lubrication used will depend on material to be bent. A generous amount of lubrication may be applied to mandrel and inside of tube, however precautions should be taken to avoid getting lubrication on center former and clamp die. Proper lubrication is important to making good bends.



# Mandrel Tooling Order Form

Fax Completed Form To: (563) 391-7710

Company Name: \_\_\_\_\_ Contact: \_\_\_\_\_ Date: \_\_\_\_\_

Address: \_\_\_\_\_

City: \_\_\_\_\_ State: \_\_\_\_\_ Zip: \_\_\_\_\_

Telephone: \_\_\_\_\_ Fax: \_\_\_\_\_ Email: \_\_\_\_\_

Distributor Name: \_\_\_\_\_ Contact: \_\_\_\_\_

### Material Specifications:

Tube/Pipe Dimensions: \_\_\_\_\_ OD \_\_\_\_\_ ID

Wall Thickness: \_\_\_\_\_

Material Type/Grade: \_\_\_\_\_

Weld Seam: \_\_\_\_\_ Yes \_\_\_\_\_ No

No. Parts Per Day: \_\_\_\_\_ No. Bends Per Part: \_\_\_\_\_

Prints Supplied: \_\_\_\_\_ Yes \_\_\_\_\_ No

Are Mill Certs Available \_\_\_\_\_ Yes \_\_\_\_\_ No

Centerline Radius (CLR): \_\_\_\_\_

Min. Dist. Bet. Bends (G): \_\_\_\_\_

Outside Diameter (OD): \_\_\_\_\_

Maximum Degree of Bend: \_\_\_\_\_

### Center Former

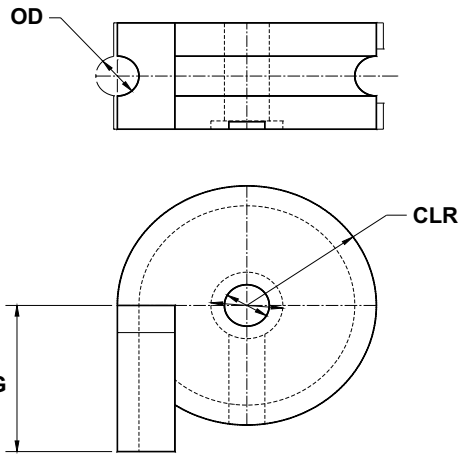

### Mandrel Information:

Mounting Thread on Mandrel (MT): \_\_\_\_\_

Length of Shank (L): \_\_\_\_\_

Number of Spheres Required: \_\_\_\_\_

Diameter of Mandrel (D): \_\_\_\_\_

Mandrel Material: \_\_\_\_\_ AMPCO Bronze \_\_\_\_\_ Steel/Chrome Plated

### Mandrel

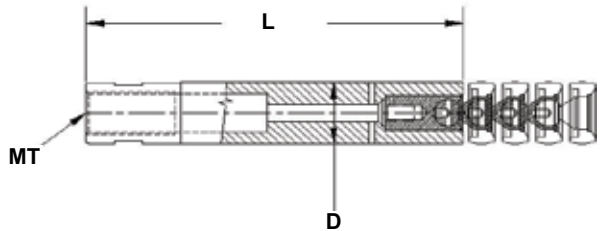

Pressure Die: \_\_\_\_\_ Steel \_\_\_\_\_ Polymer

Wiper Die Required: \_\_\_\_\_ Yes \_\_\_\_\_ No

Clamp Die: \_\_\_\_\_ Smooth \_\_\_\_\_ Serrated

Notes: \_\_\_\_\_

\_\_\_\_\_

\_\_\_\_\_

\_\_\_\_\_

I have reviewed the above information for accuracy and confirm it is correct. Any alterations made from original information will result in additional cost and may extend delivery time.

Customer Signature

Date

# Initial Quotation Information

Date:		
Company Name:		
Contact:		
Position/Title:		
Address:		
Address:		
City:	State:	
Zip/Postal Code:		
Telephone:		
Fax:		
Email:		
Cell/Alternate Phone:		
Website:		

Fill in requested information to help us serve you better.

Call: 563-391-7700

Fax: 563-391-7710

Email: [info@ercolina-usa.com](mailto:info@ercolina-usa.com)

### Tooling Information

Are product prints available?  Yes  No

Number of bends per part:	
Overall developed length of part:	
Desired centerline radius:	
Minimum distance between bends:	
Outside material diameter:	
Maximum degree of bend:	

Please specify any tolerances to be held on part shape including ovality, wall thinning and cosmetic concerns:

--

### Origin of Contact

Phone In

Internet / Email

Dealer Dealer Name:

Trade Show / Exhibition Show Name:

Referral Referred By:

Advertisement Publication:

### Application Information

Brief Description of Application:
-----------------------------------

### Material Information

ASTM material grade:	
Outside diameter:	
Wall thickness:	
Min/Max Tube Length:	

Is this a new or existing project?

Are you currently making this part or outsourcing?

If you are producing, explain process or equipment utilized:

Anticipated production requirement:

Number of shifts:

How soon will you require a machine?

Do you have financing in place or would you like leasing information?

### Follow Up Activity

Would you like to schedule a visit with an Ercolina representative?  Yes  No

Will you be sending materials to be bent?  Yes  No

Would you like to arrange a visit to our factory to view a machine under power?  Yes  No

Comments:
-----------

# Standard Mandrel Tooling Sets\*

MATERIAL	WALL	CLR	ITEM CODE	DESCRIPTION	FITS MODEL	
1" Pipe		2.5"	AK20DP1000	Tool Set with Center Former, Clamp Die, Wiper Die, Pressure Die	030, TM76, EB65, EB76, TB80-A/P80NC	
1" Pipe Sch. 5	.065		AXKITSP1000065	Mandrel Flexible <b>STEEL</b> with Sphere		
1" Pipe Sch. 10	.109		AXKITSP1000109			
1" Pipe Sch. 40	.133		AXKITSP1000133			
1" Pipe Sch. 5	.065		AXKITBP1000065	Mandrel Flexible <b>BRONZE</b> with Sphere		
1" Pipe Sch. 10	.109		AXKITBP1000109			
1" Pipe Sch. 40	.133		AXKITBP1000133			
1" Pipe			EB068P1000	Spring Collet Tailstock		TM76, EB65
1" Pipe			GB90COP1000	Segmented Collet		TB80-A/P80NC
1" Pipe			EB76P1000	Segmented Collet		EB76
1-1/4" Pipe		3"	AK20DP1250	Tool Set with Center Former, Clamp Die, Wiper Die, Pressure Die	030, TM76, EB65, EB76, TB80-A/P80NC	
1-1/4" Pipe Sch. 5	.065		AXKITSP1250065	Mandrel Flexible <b>STEEL</b> with Sphere		
1-1/4" Pipe Sch. 10	.109		AXKITSP1250109			
1-1/4" Pipe Sch. 40	.140		AXKITSP1250140			
1-1/4" Pipe Sch. 5	.065		AXKITBP1250065	Mandrel Flexible <b>BRONZE</b> with Sphere		
1-1/4" Pipe Sch. 10	.109		AXKITBP1250109			
1-1/4" Pipe Sch. 40	.140		AXKITBP1250140			
1-1/4" Pipe			EB068P1250	Spring Collet Tailstock		TM76, EB65
1-1/4" Pipe			GB90COP1250	Segmented Collet		TB80-A/P80NC
1-1/4" Pipe			EB76P1250	Segmented Collet		EB76
1-1/2" Pipe		3"	AK20DP1500	Tool Set with Center Former, Clamp Die, Wiper Die, Pressure Die	030, TM76, EB65, EB76, TB80-A/P80NC	
1-1/2" Pipe Sch. 5	.065		AXKITSP1500065	Mandrel Flexible <b>STEEL</b> with Sphere		
1-1/2" Pipe Sch. 10	.109		AXKITSP1500109			
1-1/2" Pipe Sch. 40	.145		AXKITSP1500145			
1-1/2" Pipe Sch. 5	.065		AXKITBP1500065	Mandrel Flexible <b>BRONZE</b> with Sphere		
1-1/2" Pipe Sch. 10	.109		AXKITBP1500109			
1-1/2" Pipe Sch. 40	.145		AXKITBP1500145			
1-1/2" Pipe			EB068P1500	Spring Collet Tailstock		TM76, EB65
1-1/2" Pipe			GB90COP1500	Segmented Collet		TB80-A/P80NC
1-1/2" Pipe			EB76P1500	Segmented Collet		EB76
2" Pipe		5"	AK20DP2000	Tool Set with Center Former, Clamp Die, Wiper Die, Pressure Die	030, TM76, EB65, EB76, TB80-A/P80NC	
2" Pipe Sch. 5	.065		AXKITSP2000065	Mandrel Flexible <b>STEEL</b> with Sphere		
2" Pipe Sch. 10	.109		AXKITSP2000109			
2" Pipe Sch. 40	.154		AXKITSP2000154			
2" Pipe Sch. 5	.065		AXKITBP2000065	Mandrel Flexible <b>BRONZE</b> with Sphere		
2" Pipe Sch. 10	.109		AXKITBP2000109			
2" Pipe Sch. 40	.154		AXKITBP2000154			
2" Pipe			EB068P2000	Spring Collet Tailstock		TM76, EB65
2" Pipe			GB90COP2000	Segmented Collet		TB80-A/P80NC
2" Pipe			EB76P2000	Segmented Collet		EB76
1" Tube		2"	AK20DT1000	Tool Set with Center Former, Clamp Die, Wiper Die, Pressure Die	030, TM76, EB65, EB76, TB80-A/P80NC	
1" Tube 16 Ga.	.065		AXKITST1000065	Mandrel Flexible <b>STEEL</b> with Sphere		
1" Tube 14 Ga.	.083		AXKITST1000083			
1" Tube 11 Ga.	.120		AXKITST1000120			
1" Tube 16 Ga.	.065		AXKITBT1000065	Mandrel Flexible <b>BRONZE</b> with Sphere		
1" Tube 14 Ga.	.083		AXKITBT1000083			
1" Tube 11 Ga.	.120		AXKITBT1000120			
1" Tube			EB068T1000	Spring Collet Tailstock		TM76, EB65
1" Tube			GB90COT1000	Segmented Collet		TB80-A/P80NC
1" Tube			EB76T1000	Segmented Collet		EB76
1-1/4" Tube		2.5"	AK20DT1250	Tool Set with Center Former, Clamp Die, Wiper Die, Pressure Die	030, TM76, EB65, EB76, TB80-A/P80NC	
1-1/4" Tube 16 Ga.	.065		AXKITST1250065	Mandrel Flexible <b>STEEL</b> with Sphere		
1-1/4" Tube 14 Ga.	.083		AXKITST1250083			
1-1/4" Tube 11 Ga.	.120		AXKITST1250120			
1-1/4" Tube 16 Ga.	.065		AXKITBT1250065	Mandrel Flexible <b>BRONZE</b> with Sphere		
1-1/4" Tube 14 Ga.	.083		AXKITBT1250083			
1-1/4" Tube 11 Ga.	.120		AXKITBT1250120			
1-1/4" Tube			EB068T1250	Spring Collet Tailstock		TM76, EB65
1-1/4" Tube			GB90COT1250	Segmented Collet		TB80-A/P80NC
1-1/4" Tube			EB76T1250	Segmented Collet		EB76
1-1/2" Tube		2.25"	AK15DT1500	Tool Set with Center Former, Clamp Die, Wiper Die, Pressure Die	030, TM76, EB65, EB76, TB80-A/P80NC	
1-1/2" Tube		3"	AK20DT1500	Tool Set with Center Former, Clamp Die, Wiper Die, Pressure Die		
1-1/2" Tube 16 Ga.	.065		AXKITST1500065	Mandrel Flexible <b>STEEL</b> with Sphere		
1-1/2" Tube 14 Ga.	.083		AXKITST1500083			
1-1/2" Tube 11 Ga.	.120		AXKITST1500120			
1-1/2" Tube 16 Ga.	.065		AXKITBT1500065	Mandrel Flexible <b>BRONZE</b> with Sphere		
1-1/2" Tube 14 Ga.	.083		AXKITBT1500083			
1-1/2" Tube 11 Ga.	.120		AXKITBT1500120			
1-1/2" Tube			EB068T1500	Spring Collet Tailstock		TM76, EB65
1-1/2" Tube			GB90COT1500	Segmented Collet		TB80-A/P80NC
1-1/2" Tube			EB76T1500	Segmented Collet	EB76	

# Standard Mandrel Tooling Sets\*

MATERIAL	WALL	CLR	ITEM CODE	DESCRIPTION	FITS MODEL	
1-5/8" Tube		3.25"	AK20DT1625	Tool Set with Center Former, Clamp Die, Wiper Die, Pressure Die	030, TM76, EB65, EB76, TB80-A/P80NC	
1-5/8" Tube 16 Ga.	.065		AXKITST1625065	Mandrel Flexible <b>STEEL</b> with Sphere		
1-5/8" Tube 14 Ga.	.083		AXKITST1625083			
1-5/8" Tube 11 Ga.	.120		AXKITST1625120	Mandrel Flexible <b>BRONZE</b> with Sphere		
1-5/8" Tube 16 Ga.	.065		AXKITBT1625065			
1-5/8" Tube 14 Ga.	.083		AXKITBT1625083			
1-5/8" Tube 11 Ga.	.120		AXKITBT1625120			
1-5/8" Tube			EB068T1625	Spring Collet Tailstock		TM76, EB65
1-5/8" Tube			GB90COT1625	Segmented Collet		TB80-A/P80NC
1-5/8" Tube			EB76T1625	Segmented Collet		EB76
1-3/4" Tube		3.5"	AK20DT1750	Tool Set with Center Former, Clamp Die, Wiper Die, Pressure Die	030, TM76, EB65, EB76, TB80-A/P80NC	
1-3/4" Tube 16 Ga.	.065		AXKITST1750065	Mandrel Flexible <b>STEEL</b> with Sphere		
1-3/4" Tube 14 Ga.	.083		AXKITST1750083			
1-3/4" Tube 11 Ga.	.120		AXKITST1750120	Mandrel Flexible <b>BRONZE</b> with Sphere		
1-3/4" Tube 16 Ga.	.065		AXKITBT1750065			
1-3/4" Tube 14 Ga.	.083		AXKITBT1750083			
1-3/4" Tube 11 Ga.	.120		AXKITBT1750120			
1-3/4" Tube			EB068T1750	Spring Collet Tailstock		TM76, EB65
1-3/4" Tube			GB90COT1750	Segmented Collet		TB80-A/P80NC
1-3/4" Tube			EB76T1750	Segmented Collet		EB76
2" Tube		4"	AK20DT2000	Tool Set with Center Former, Clamp Die, Wiper Die, Pressure Die	030, TM76, EB65, EB76, TB80-A/P80NC	
2" Tube 16 Ga.	.065		AXKITST2000065	Mandrel Flexible <b>STEEL</b> with Sphere		
2" Tube 14 Ga.	.083		AXKITST2000083			
2" Tube 11 Ga.	.120		AXKITST2000120	Mandrel Flexible <b>BRONZE</b> with Sphere		
2" Tube 16 Ga.	.065		AXKITBT2000065			
2" Tube 14 Ga.	.083		AXKITBT2000083			
2" Tube 11 Ga.	.120		AXKITBT2000120			
2" Tube			EB068T2000	Spring Collet Tailstock		TM76, EB65
2" Tube			GB90COT2000	Segmented Collet		TB80-A/P80NC
2" Tube			EB76T2000	Segmented Collet		EB76
2-1/4" Tube		4.5"	AK20DT2250	Tool Set with Center Former, Clamp Die, Wiper Die, Pressure Die	030, TM76, EB65, EB76, TB80-A/P80NC	
2-1/4" Tube 16 Ga.	.065		AXKITST2250065	Mandrel Flexible <b>STEEL</b> with Sphere		
2-1/4" Tube 14 Ga.	.083		AXKITST2250083			
2-1/4" Tube 11 Ga.	.120		AXKITST2250120	Mandrel Flexible <b>BRONZE</b> with Sphere		
2-1/4" Tube 16 Ga.	.065		AXKITBT2250065			
2-1/4" Tube 14 Ga.	.083		AXKITBT2250083			
2-1/4" Tube 11 Ga.	.120		AXKITBT2250120			
2-1/4" Tube			EB068T2250	Spring Collet Tailstock		TM76, EB65
2-1/4" Tube			GB90COT2250	Segmented Collet		TB80-A/P80NC
2-1/4" Tube			EB76T2250	Segmented Collet		EB76
2-1/2" Tube		5"	AK20DT2500	Tool Set with Center Former, Clamp Die, Wiper Die, Pressure Die	030, TM76, EB65, EB76, TB80-A/P80NC	
2-1/2" Tube 16 Ga.	.065		AXKITST2500065	Mandrel Flexible <b>STEEL</b> with Sphere		
2-1/2" Tube 14 Ga.	.083		AXKITST2500083			
2-1/2" Tube 11 Ga.	.120		AXKITST2500120	Mandrel Flexible <b>BRONZE</b> with Sphere		
2-1/2" Tube 16 Ga.	.065		AXKITBT2500065			
2-1/2" Tube 14 Ga.	.083		AXKITBT2500083			
2-1/2" Tube 11 Ga.	.120		AXKITBT2500120			
2-1/2" Tube			EB068T2500	Spring Collet Tailstock		TM76, EB65
2-1/2" Tube			GB90COT2500	Segmented Collet		TB80-A/P80NC
2-1/2" Tube			EB76T2500	Segmented Collet		EB76
3" Tube		6"	AK20DT3000	Tool Set with Center Former, Clamp Die, Wiper Die, Pressure Die	TM76, EB76, TB80-A/P80NC	
3" Tube 16 Ga.	.065		AXKITST3000065	Mandrel Flexible <b>STEEL</b> with Sphere		
3" Tube 14 Ga.	.083		AXKITST3000083			
3" Tube 11 Ga.	.120		AXKITST3000120	Mandrel Flexible <b>BRONZE</b> with Sphere		
3" Tube 16 Ga.	.065		AXKITBT3000065			
3" Tube 14 Ga.	.083		AXKITBT3000083			
3" Tube 11 Ga.	.120		AXKITBT3000120			
3" Tube			EB068T3000	Spring Collet Tailstock		TM76
3" Tube			GB90COT3000	Segmented Collet		TB80-A/P80NC
3" Tube			EB76T3000	Segmented Collet		EB76

### Decoding Bend Terms

CLR – Centerline radius. Distance from the center of forming die to centerline of material

DOB – Degree of bend. Number of degrees required in a bend

Sch. – Schedule, or wall thickness of pipe

Ga. – Gauge, or wall thickness of tube

O.D. – Outside diameter

I.D. – Inside diameter

**\* COMPLETE SETS GUARANTEED IN STOCK**



# Automate Your Shop to Maximize ROI

## Automate your shop with an Ercolina CNC Bender

Calculating return on investment (ROI) can provide valuable insight into your company's potential business profit and future growth. In today's competitive economic situation, you have likely automated your shop's manufacturing capacity and functions in other areas. Why not consider bending automation? Let's get started and see how using Ercolina CNC can increase profit, shop capacity, improve productivity and make you more competitive. The following information reinforces the value in purchasing an Ercolina CNC handrail tube and pipe bender. Most importantly you are purchasing from a professional company with a great track record of supplying quality machines and supporting their customers.

## Analyzing your Return on Investment

Begin by reviewing present bending capacity, consider...

- How many bending machines are being used?
- How many employees are required to operate each machine?
- Is each employee qualified to operate the machine and prepare pre-bend layout operations? Often times only certain operators are truly efficient in both.
- What is your average labor rate for a skilled worker?
- Do current bending procedures require more than one operator work together to produce longer pieces, control part level and bend rotation?
- What percentage of parts produced become scrap?
- What after post-bend operations are currently required?  
Examples include: correcting the bend angle by heating with a torch, cutting material off after the bend, welding elbows, grinding weld seams etc.
- What consumables are required? Weld rod, gas, grinding wheels, extra material, etc.

Based on average hours per work consumed bending	10 hours
Number of employees required for bending	4
Estimated hourly shop cost of employee	\$65 per hour
Total labor cost of bending	\$2600 (10x4x65)
Time required with CNC machine	3 hours
Number of employees required for bending with CNC	1
Total labor cost of bending with CNC	\$195 (3x1x65)
<b>Labor Cost Reduction</b>	<b>\$2405</b>



### How much faster is CNC bending?

For comparison a highly skilled operator using Ercolina's NC semiautomatic models can produce a single handrail with four bends in approximately fifteen minutes, assuming the part was previously marked off and prepared for bending. Ercolina's CNC Bender can produce the same four bend handrail from start to finish including programming time in less than five minutes. This represents a seventy percent improvement. CNC owners can easily complete several handrails in minutes. Future handrails can easily be reproduced by recalling the bend program.

### Controlling Cost

When you really think about it, labor represents the one area employers do control. Other cost to be considered includes: material, insurance, building, supplies, state and federal tax workman's compensation insurance and healthcare.

### Value added benefits for business owners of Ercolina CNC benders

Begin by reviewing present bending capacity, consider...

- Mandrel benders produce higher quality work and overall part appearance
- CNC machines accurately produce more work with less labor
- Improved customer satisfaction through better delivery and pricing
- Less rework and material scrap
- Industry recognition as a top tier go-to fabricator
- Increased shop workload capacity
- Reliable labor cost for quoting purposes



## Interested in purchasing an Ercolina CNC Mandrel Bender?

To assist you in traveling to see a demo of a CNC machine, we're offering the **"YOU BUY...WE FLY"** promotion.

We will reimburse you for the cost of your flight (up to \$500) and one night's lodging after you have purchased a CNC Mandrel Bender.



# Model Comparison Guide

Model	030 Mandrel Bender	TB80 Mandrel	Erco Series	GB Series
<b>OPERATOR CONTROL</b>				
LCD with PLC touchpad	✓			
Touch screen				
Color touch screen		✓	✓	✓
Independent control of Clamp, Mandrel Functions	✓			
Manual override control of Clamp, Pressure Die, Boost, Mandrel, Clamp release function		✓	✓	✓
Inch or Metric display	✓			
Inch and Metric programming and display		✓	✓	✓
Manual or Semi Auto mode	✓	✓		
Manual, Semi Auto and Auto modes			✓	✓
<b>PROGRAMMING</b>				
(30) programs - up to (9) bend angle and springback settings per program	✓			
Unlimited program storage with USB		✓	✓	✓
<b>BENDING SOFTWARE</b>				
Bend-Tech for Ercolina designs part creates print with complete bend dimensions. Can manually output to XYZ values.	✓	✓	✓	✓
<b>MACHINE DESIGN</b>				
C axis electro mechanical operation with gear reduction. Main frame aluminum case.	✓			
C axis electro mechanical operation with gear reduction. Main frame GS500 cast steel case.		✓		
C axis hydraulic operation with rack and pinion. Main frame GS500 cast steel case.			✓	
C axis chain driven hydraulic operation. Main frame GS500 cast steel case.				✓
Analog encoders for C axis, Counter Die Axis display position on control. LED on table to monitor length and rotation from original bend plane (YB).	✓			
Digital encoders for three axis with digital display of absolute or incremental position on touch screen.		✓	✓	✓
Tailstock pneumatic clamping with four interchangeable jaw sets. 2½" capacity.	✓			
Tailstock hydraulic clamping with segment collet. 3½" through spindle capacity, 3" material capacity with collet.		✓		
Tailstock hydraulic clamping with segment collet. 2½" through spindle capacity, 3" material capacity with collet.			✓	
Tailstock hydraulic clamping with segment collet. Large through spindle capacity, Material capacity to 8" pipe dependent on model.				✓
Programmable mandrel extraction	✓	✓	✓	✓

Factory on-site training available.

Contact CML USA for complete technical specifications.

All capacities based on mild grade materials; heavy wall and high tensile materials reduce machine capacity.

# ANGLE ROLLS SECTION BENDERS

ANGLE ROLL - SECTION BENDERS





# Why choose Ercolina Angle Rolls?

## Ercolina Advantages

All Ercolina hydraulic machines have **unlimited** step programming with memory and unlimited passes which is important when rolling parts

Ercolina rolls feature patented simultaneous downfeed and roll movement to minimize part deformation when making roll passes

Ercolina shafts and tooling are forged  
*(Forging generally produces a piece that is stronger than a similar cast or machined part. During the forging process, the metal's internal grain deforms to follow the general shape of the part. The resulting grain is continuous throughout the part creating a piece with improved strength characteristics and reliability.)*

Ercolina A-frames are engineered for greater strength and offer a lifetime warranty

Ercolina utilizes heavy lateral guides to control material during bending

Ercolina rolls are three-roll-driven with inline gear reduction for greater torque; power transmission and motor are located close to the A-frame

Ercolina hydraulic rolls have locking third hydraulic solenoid to maintain accurate cylinder position

Ercolina capacity ratings are accurate and machines will perform as advertised with standard tooling

Ercolina hydraulic cylinder is located inside the cabinet and cannot interfere with part production

Ercolina rolls include a slip clutch on drive to protect machine components when rolling

Ercolina design and tooling accommodate most standard material

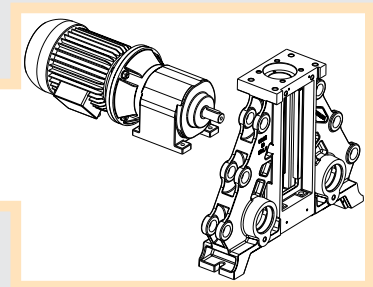
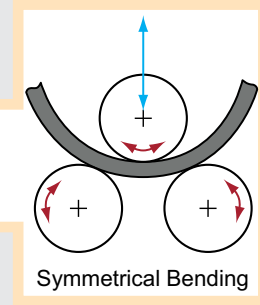

**CE40MR3 (Manual)**  
**CE40H3 (Hydraulic)**  
2" Sch. 40 pipe capacity  
2" angle iron capacity  
220V or 440V 3ph



**CE50H3 (Hydraulic)**  
2-1/2" Sch. 40 pipe capacity  
2-1/2" angle iron capacity  
220V or 440V 3ph



**CE60H3 (Hydraulic)**  
3" Sch. 10 pipe capacity  
2-1/2" angle iron capacity  
220V or 480V 3ph

**Ercolina offers a better machine at a competitive price.**

### Competitors' Machines

Operator is required to manually control step movement which is inefficient and less accurate

Downward movement of center roll causes deformation when taking roll passes

Shafts and tooling are turned and hardened which are more likely to flex during bending

A-frames use welded steel plate or billet allowing weight to compensate for older design

Weaker lateral guides do not offer required support

Motors are further away and the drive train is at 90 degrees which requires a larger motor to overcome the transition

Rely on single solenoid

Competitors often over-state capacity ratings

Hydraulic cylinder located at top of machine can interfere with part production

If vibration occurs during bending process, some competitors suggest removing the key drive from the lower right shaft to make the rolls freewheeling

Stated capacities often require special tooling

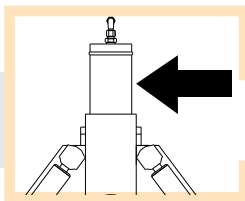
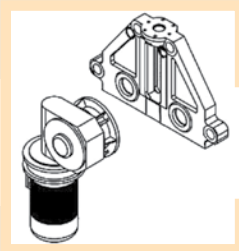

**CE70H3 (Hydraulic)**  
3" Sch. 40 pipe capacity  
3" angle iron capacity  
220V or 440V 3ph



**CE100H3-RLI (Hydraulic)**  
4" Sch. 40 pipe capacity  
4" angle iron capacity  
220V or 440V 3ph





# CE40MR3 Angle Roll

## Manual Angle Roll • Section Bender

**Fabricators Favorite**



Universal Tooling Set Included for Multiple Profiles



**Two-Speed Gear Box**

- 1 - Torque or fine adjustment
- 2 - Rapid or coarse adjustment



Vertical or Horizontal Operating Position



## Manual Center Roll Positioning

### FEATURES

- Universal tooling set forged with smooth surface included with each machine
- Forged roll shafts precision ground and fitted for maximum performance and minimal deflection
- Roll shafts supported with conical steel bearings on each side of A Frame
- Heavy duty structure and rigid components for high section modulus ratings
- Reinforced engineered mainframe design proven to outperform competitive models
- In-line direct drive roll shaft system 3-roll driven
- Threaded roll shafts with micrometric flange adjustment helps eliminate spacer usage
- Touchpad control with digital readout of center roll positioning
- Control tower with low voltage controls and foot pedal
- 2-speed gear box with torque multiplier for positioning center roll
- Optional anti-twist correction system required for angle iron "Leg In" applications

## CE40MR3 Capacities & Specifications

Pipe (Max.)	2" Sch. 40
Angle (Max.)	2" x 2" x 1/4"
Tube (Max.)	2 1/2" - .125 wall
Roll Shaft Diameter	40mm
Center Roll Positioning	Manual with patented torque multiplier
Shaft Speed	10 RPM
Universal Tooling (Included)	6 5/8" O.D.
Programming	Not available
Distance between Shafts	10 5/8"
Operating Voltage	220V or 480V 3ph
Length, Width, Height	39" x 26" x 59"

All capacities based on mild grade materials; heavy wall and high tensile materials reduce machine capacity.

### POPULAR ACCESSORIES



Spray Lubricant



Pipe & Tube Tooling



Anti-Twist Device



Small Radius Tooling



Radius & Degree Measuring Kit

Minimum Radius Guide [Pages 72-73](#)

Tooling Sets [Pages 74-76](#)

Accessories [Pages 77-80](#)



◀ Ercolina Bending Application

**Product Demonstrations Available on Website**

**NEED ADDITIONAL HELP? CONTACT ERCOLINA:**

**563.391.7700**

[info@ercolina-usa.com](mailto:info@ercolina-usa.com)



# CE40H3 Angle Roll

Hydraulic Angle Roll • Section Bender

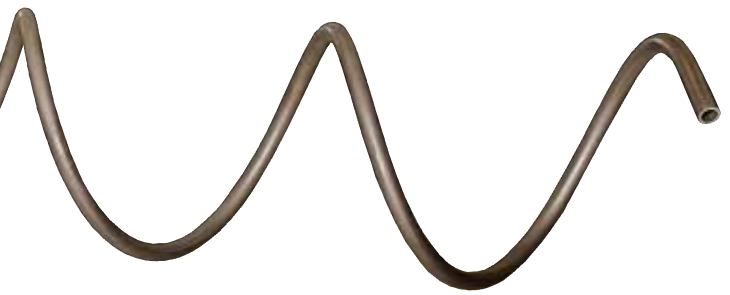

Universal Tooling Set Included for Multiple Profiles



Vertical or Horizontal Operating Position



Pipe Capacity



## Hydraulic Center Roll Positioning

### FEATURES

- Universal tooling set included with each machine
- Forged roll shafts precision ground and fitted for maximum performance and minimal deflection
- Roll shafts supported with conical steel bearings on each side of A Frame
- Heavy duty structure and rigid components for high section modulus ratings
- Reinforced engineered mainframe design proven to outperform competitive models
- In-line direct drive roll shaft system 3-roll driven
- Threaded roll shafts with micrometric flange adjustment helps eliminate spacer usage
- Touchpad controls with digital center roll positioning
- Control tower with low voltage controls and foot pedal
- Machine with memory storage has eight (8) individual programs and unlimited passes
- Patented by Ercolina, simultaneous downfeed and roll movement minimizes deformation
- Optional anti-twist correction system required for angle iron "Leg In" applications



## CE40H3 Capacities & Specifications

Pipe (Max.)	2" Sch. 40
Angle (Max.)	2" x 2" x 1/4"
Tube (Max.)	2 1/2" - .125 wall
Roll Shaft Diameter	40mm
Center Roll Positioning	Hydraulic 10 Tons
Shaft Speed	10 RPM
Universal Tooling (Included)	6 5/8" O.D.
Programming	NC - Touchpad
Distance between Shafts	10 5/8"
Operating Voltage	220V or 480V 3ph
Length, Width, Height	39" x 26" x 59"

All capacities based on mild grade materials;  
heavy wall and high tensile materials reduce machine capacity.

### POPULAR ACCESSORIES



**Spray Lubricant**



**Pipe & Tube Tooling**



**Anti-Twist Device**



**Small Radius Tooling**



**Radius & Degree Measuring Kit**

**Minimum Radius  
Guide [Pages 72-73](#)**

**Tooling Sets [Pages 74-76](#)**

**Accessories [Pages 77-80](#)**



◀ **Ercolina Bending Application**

**Product  
Demonstrations  
Available on Website**

**NEED ADDITIONAL HELP?  
CONTACT ERCOLINA:**

**563.391.7700**

**info@ercolina-usa.com**

Air display at the Red Rock Canyon Visitor Center



# CE50H3 Angle Roll

## Hydraulic Angle Roll • Section Bender

**✓ Fabricators Favorite**



Universal Tooling Set Included for Multiple Profiles

**2 1/2"**  
Sch. 40  
Pipe Capacity

**1 Year**  
Limited  
WARRANTY

Vertical or Horizontal  
Operating Position



Shown with optional  
Large Radius Spiral  
Bending Accessory

## Hydraulic Downfeed Improves Productivity

### FEATURES

- Universal tooling set included with each machine
- Forged roll shafts precision ground and fitted for maximum performance and minimal deflection
- Roll shafts supported with conical steel bearings on each side of A Frame
- Heavy duty structure and rigid components for high section modulus ratings
- Reinforced engineered mainframe design proven to outperform competitive models
- In-line direct drive roll shaft system 3-roll driven
- Threaded roll shafts with micrometric flange adjustment helps eliminate spacer usage
- Touchpad controls with digital center roll positioning
- Control tower with low voltage controls and foot pedal
- Hydraulic machine with memory storage has eight (8) individual programs and unlimited passes
- Patented by Ercolina, simultaneous downfeed and roll movement minimizes deformation
- Optional anti-twist correction system required for angle iron "Leg In" applications

## CE50H3 Capacities & Specifications

Pipe (Max.)	2½" Sch. 40
Angle (Max.)	2½" x 2½" x ¼"
Tube (Max.)	3" – .095 wall
Roll Shaft Diameter	50mm
Center Roll Positioning	Hydraulic 10 Tons
Shaft Speed	9 RPM
Universal Tooling (Included)	7" O.D.
Programming	NC - Touchpad
Number of Programs	8
Distance between Shafts	11⅞"
Operating Voltage	220V or 480V 3ph
Length, Width, Height	45" x 29" x 52"

All capacities based on mild grade materials; heavy wall and high tensile materials reduce machine capacity.

### POPULAR ACCESSORIES



Spray Lubricant



Pipe & Tube Tooling



Anti-Twist Device



Small Radius Tooling



Radius & Degree Measuring Kit

Minimum Radius Guide [Pages 72-73](#)

Tooling Sets [Pages 74-76](#)

Accessories [Pages 77-80](#)



◀ Ercolina Bending Application

**Product Demonstrations Available on Website**

**NEED ADDITIONAL HELP? CONTACT ERCOLINA:**

**563.391.7700**

[info@ercolina-usa.com](mailto:info@ercolina-usa.com)



# CE60H3 Angle Roll

## Hydraulic Angle Roll • Section Bender



**3"**  
Sch. 10  
Pipe Capacity

**1 Year**  
Limited  
WARRANTY

Vertical or Horizontal  
Operating Position



Universal Tooling Set Included for Multiple Profiles



## Hydraulic Downfeed Improves Productivity

### FEATURES

- Universal tooling set included with each machine
- Forged roll shafts precision ground and fitted for maximum performance and minimal deflection
- Roll shafts supported with conical steel bearings on each side of A Frame
- Heavy duty structure and rigid components for high section modulus ratings
- Reinforced engineered mainframe design proven to outperform competitive models
- In-line direct drive roll shaft system 3-roll driven
- Uses CE50 tooling
- Threaded roll shafts with micrometric flange adjustment helps eliminate spacer usage
- Touchpad controls with digital center roll positioning
- Control tower with low voltage controls and foot pedal
- Hydraulic machine with memory storage has eight (8) individual programs and unlimited passes
- Patented by Ercolina, simultaneous downfeed and roll movement minimizes deformation
- Optional anti-twist correction system required for angle iron "Leg In" applications
- Tie bar supports for each shaft included

## CE60H3 Capacities & Specifications

Pipe (Max.)	3" Sch. 10
Angle (Max.)	2½" x 2½" x ⅜"
Tube (Max.)	3½" – .120 wall
Roll Shaft Diameter	50mm
Center Roll Positioning	Hydraulic 16.5 Tons
Shaft Speed	9 RPM
Universal Tooling (Included)	7" O.D.
Programming	NC - Touchpad
Number of Programs	8
Distance between Shafts	15"
Operating Voltage	220V or 480V 3ph
Length, Width, Height	48" x 29" x 52"

All capacities based on mild grade materials; heavy wall and high tensile materials reduce machine capacity.

### POPULAR ACCESSORIES



Spray Lubricant



Pipe & Tube Tooling



Anti-Twist Device



Large Spiral Accessory



Radius & Degree Measuring Kit

Minimum Radius  
Guide [Pages 72-73](#)

Tooling Sets [Pages 74-76](#)

Accessories [Pages 77-80](#)



◀ Ercolina Bending Application

**Product  
Demonstrations  
Available on Website**

**NEED ADDITIONAL HELP?  
CONTACT ERCOLINA:**

**563.391.7700**

[info@ercolina-usa.com](mailto:info@ercolina-usa.com)



# CE70H3-RLI Angle Roll

## Hydraulic Angle Roll • Section Bender



Universal Tooling Set Included for Multiple Profiles

CE70H3-RLI w/Hydraulic 3 Axis Twist



Vertical or Horizontal Operating Position



## Heavy Duty Structure for High Section Modulus Rating

### FEATURES

- Universal tooling set included with each machine
- Forged roll shafts precision ground and fitted for maximum performance and minimal deflection
- Roll shafts supported with conical steel bearings on each side of A Frame
- Heavy duty structure and rigid components for high section modulus ratings
- Reinforced engineered mainframe design proven to outperform competitive models
- In-line direct drive roll shaft system with motor and brake on each shaft
- Threaded roll shafts with micrometric flange adjustment helps eliminate spacer usage
- Touchpad controls with digital center roll positioning
- Control tower with low voltage controls and foot pedal
- Memory storage has eight (8) individual programs and unlimited passes
- Three axis hydraulic twist correction system for angle iron "Leg-in" applications

## CE70H3-RLI Capacities & Specifications

Pipe (Max.)	3" Sch. 40
Angle (Max.)	3" x 3" x 3/8"
Tube (Max.)	3 1/2" - .216 wall
Roll Shaft Diameter	70mm
Center Roll Positioning	Hydraulic 16 Tons
Shaft Speed	8 RPM
Universal Tooling (Included)	9 1/2" O.D.
Programming	NC - Touchpad
Number of Programs	8
Distance between Shafts	15"
Section Modulus	35 cm <sup>3</sup>
Operating Voltage	220V or 480V 3ph
Length, Width, Height	54" x 43" x 57"

All capacities based on mild grade materials; heavy wall and high tensile materials reduce machine capacity.

### POPULAR ACCESSORIES



Spray Lubricant



Pipe & Tube Tooling



Modular Tooling Set

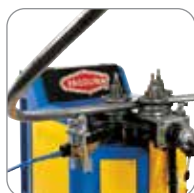

Large Spiral Accessory



Radius & Degree Measuring Kit

Minimum Radius  
Guide [Pages 72-73](#)

Tooling Sets [Pages 74-76](#)

Accessories [Pages 77-80](#)



◀ Ercolina Bending Application

**Product  
Demonstrations  
Available on Website**

**NEED ADDITIONAL HELP?  
CONTACT ERCOLINA:**

**563.391.7700**

info@ercolina-usa.com



# CE100H3-RLI Angle Roll

Hydraulic Angle Roll • Section Bender



Universal Tooling Set Included for Multiple Profiles



Vertical or Horizontal Operating Position



## Maximum Performance and Minimal Deflection

### FEATURES

- Universal tooling set included with each machine
- Forged roll shafts precision ground and fitted for maximum performance and minimal deflection
- Roll shafts supported with conical steel bearings on each side of A Frame
- Heavy duty structure and rigid components for high section modulus ratings
- Reinforced engineered mainframe design proven to outperform competitive models
- In-line direct drive roll shaft system with motor and brake on each shaft
- Threaded roll shafts with micrometric flange adjustment helps eliminate spacer usage
- Touchpad controls with digital center roll positioning
- Control tower with low voltage controls and foot pedal
- Memory storage has eight (8) individual programs and unlimited passes
- Three axis hydraulic twist correction system for angle iron "Leg-in" applications



## CE100H3-RLI Capacities & Specifications

Pipe (Max.)	4" Sch. 40
Angle (Max.)	4" x 4" x 1/2"
Tube (Max.)	4 1/2" - .237 wall
Roll Shaft Diameter	100mm
Center Roll Positioning	Hydraulic 30 Tons
Shaft Speed	6 RPM
Universal Tooling (Included)	12 5/8" O.D.
Programming	NC - Touchpad
Number of Programs	8
Distance between Shafts	19 1/4"
Section Modulus	90 cm <sup>3</sup>
Operating Voltage	220V or 480V 3ph
Length, Width, Height	66" x 58" x 83"

All capacities based on mild grade materials;  
heavy wall and high tensile materials reduce machine capacity.

### POPULAR ACCESSORIES



Spray Lubricant



Pipe & Tube Tooling



Modular Tooling Set



Polymer Tooling



Radius & Degree Measuring Kit

Minimum Radius  
Guide [Pages 72-73](#)

Tooling Sets [Pages 74-76](#)

Accessories [Pages 77-80](#)



◀ Ercolina Bending Application

**Product  
Demonstrations  
Available on Website**

**NEED ADDITIONAL HELP?  
CONTACT ERCOLINA:**

**563.391.7700**

[info@ercolina-usa.com](mailto:info@ercolina-usa.com)

[ercolina-usa.com](http://ercolina-usa.com)



# Minimum Radius Guide on Mild Steel Material

Profile Type	CE40			CE50		
	Profile Dimensions	Min. CLR Inches	Wall	Profile Dimensions	Min. CLR Inches	Wall
Pipe	1/2"	6	.109	3/4"	8	.113
	1"	10	.133	2"	12	.154
	2"	18	.154	2 1/2"	16	.203
Tube	1"	6	.120	1"	6	.120
	1 1/2"	12	.120	2 1/2"	18	.120
	2 1/2"	25	.083	3"	24	.120
Square Tube	3/4" x 3/4"	6	.083	3/4" x 3/4"	6	.083
	1 1/2" x 1 1/2"	16	.083	2" x 2"	20	.120
	2" x 2"	24	.120	2 1/2" x 2 1/2"	30	.120
Rectangular Tube Hard way	1/2" x 1 1/4"	10	.083	1/2" x 1"	8	.083
	1" x 1 1/2"	12	.120	1 1/2" x 2 1/2"	18	.120
	1" x 2"	24	.120	1 1/2" x 3"	34	.120
Rectangular Tube Easy way	1 1/4" x 1/2"	10	.083	1 1/4" x 1/2"	10	.083
	2" x 1"	20	.120	2 1/2" x 1 1/2"	24	.120
				3" x 1 1/2"	32	.120
Round Solid	3/4"	4 *	NA	3/4"	4 *	NA
	1 1/4"	12	NA	1 1/2"	14	NA
Square Solid	3/4"	4 *	NA	3/4"	4 *	NA
	1"	8	NA	1 1/4"	10	NA
	1 1/4"	10	NA	1 1/2"	10	NA
Rectangular Solid Hard way	1/2" x 1 1/2"	12	NA	3/8" x 3/4"	6 *	NA
	1/4" x 2"	16	NA	1/2" x 2"	10	NA
	1/2" x 2"	18	NA	1/2" x 2 1/2"	18	NA
Rectangular Solid Easy way	1 1/4" x 3/8"	6 *	NA	2" x 1/2"	8	NA
	2 1/2" x 1/2"	8	NA	4" x 1/2"	12	NA
	3" x 1/2"	16	NA			
Angle "Leg Out"	1" x 1"	8	.120	1" x 1"	8	.120
	1 1/2" x 1 1/2"	12	.120	2" x 2"	16	.187
	2" x 2"	16	.187	2 1/2" x 2 1/2"	20	.187
Angle "Leg In"	1" x 1"	10	.120	1" x 1"	10	.120
	1 1/2" x 1 1/2"	16	.120	2" x 2"	18	.236
	2" x 2"	28	.187	2 1/2" x 2 1/2"	22	.236
C "Leg Out"	1 1/2" x 1/2"	10	.120	1 1/4" x 1/2"	10	.120
	2" x 1 1/4"	14	.187	3" x 1 1/2"	15	.187
C "Leg In"	1 1/2" x 3/4"	10	.187	1 1/2" x 3/4"	10	.187
	2 1/2" x 1 1/4"	14	.187	3" x 1 1/2"	16	.187

1. Capacities based on mild grade material, number of bending passes may vary.
2. Tie Bar accessory required for bending large profiles.
3. Two roll drive machines increase minimum CLR.

# Minimum Radius Guide on Mild Steel Material

CE60			CE70			CE100		
Profile Dimensions	Min. CLR Inches	Wall	Profile Dimensions	Min. CLR Inches	Wall	Profile Dimensions	Min. CLR Inches	Wall
3/4"	6	.113	1 1/2"	16	.145	2"	16	.154
2"	12	.154	3"	24	.216	4"	36	.237
3"	30	.216						
1"	6	.120	1 1/2"	16	.120	2"	12	.120
2 1/2"	20	.203	4"	30	.187	4"	32	.187
3 1/2"	30	.187				6"	76	.187
3/4" x 3/4"	6	.083	1 1/2" x 1 1/2"	12	.120	2" x 2"	14	.120
2" x 2"	20	.120	3" x 3"	48	.187	4" x 4"	72	.187
2 1/2" x 2 1/2"	30	.216						
1/2" x 1"	6	.083	1/2" x 1 1/2"	10	.120	1" x 2 1/2"	16	.187
1 1/2" x 2 1/2"	18	.120	2" x 4"	48	.187	2" x 4"	48	.187
1 1/2" x 4"	36	.187						
1 1/4" x 1/2"	6	.083	1 1/2" x 1/2"	10	.120	2 1/2" x 1"	14	.187
2 1/2" x 1 1/2"	24	.120	4" x 2"	72	.187	4" x 2"	72	.187
4" x 1 1/2"	60	.187						
1"	8 *	NA	1 1/4"	6 *	NA	1 1/2"	8 *	NA
1 3/4"	16	NA	2"	16	NA	2 1/2"	24	NA
5/8"	4 *	NA	1 1/2"	10 *	NA	1 1/2"	14	NA
1 1/4"	8	NA	2"	16	NA	2"	18	NA
1 3/4"	20	NA						
3/8" x 3/4"	6 *	NA	1/2" x 1 1/2"	14	NA	1/2" x 1 1/2"	16	NA
1/2" x 2"	8	NA	1/2" x 3"	32	NA	3/4" x 4"	42	NA
3/4" x 3"	40	NA						
2" x 1 1/2"	6	NA	1 1/2" x 1 1/2"	12	NA	2" x 1 1/2"	14	NA
4" x 3/4"	8	NA	4" x 1"	16	NA	6" x 1"	32	NA
1" x 1"	10	.156	1 1/2" x 1 1/2"	14	.187	2" x 2"	16	.187
2" x 2"	18	.236	3" x 3"	28	.375	3" x 3"	28	.375
2 1/2" x 2 1/2"	26	.236				4" x 4"	36	.500
1" x 1"	14	.156	1 1/2" x 1 1/2"	16	.187	2" x 2"	20	.187
2" x 2"	28	.236	3" x 3"	32	.375	3" x 3"	32	.375
2 1/2" x 2 1/2"	36	.236				4" x 4"	40	.500
1 1/2" x 3/4"	10	.156	2" x 1"	14	.187	2" x 1"	14	.187
3 1/8" x 1"	12	.236	4" x 1 1/2"	24	.187	6" x 2"	60	.375
1 1/2" x 3/4"	10	.203	2" x 1"	14	.125	2" x 1"	14	.187
4" x 1 1/2"	18	.236	4" x 1 1/2"	24	.187	6" x 2"	60	.375

\*Special tooling required

Consult CML USA, Inc. Ercolina® with application questions.

Consult factory for material and radii not shown.



# Universal Tooling Sets

All Ercolina angle roll-section bending machines **include** universal tooling sets. Universal tooling adjusts easily to bend the following profiles:

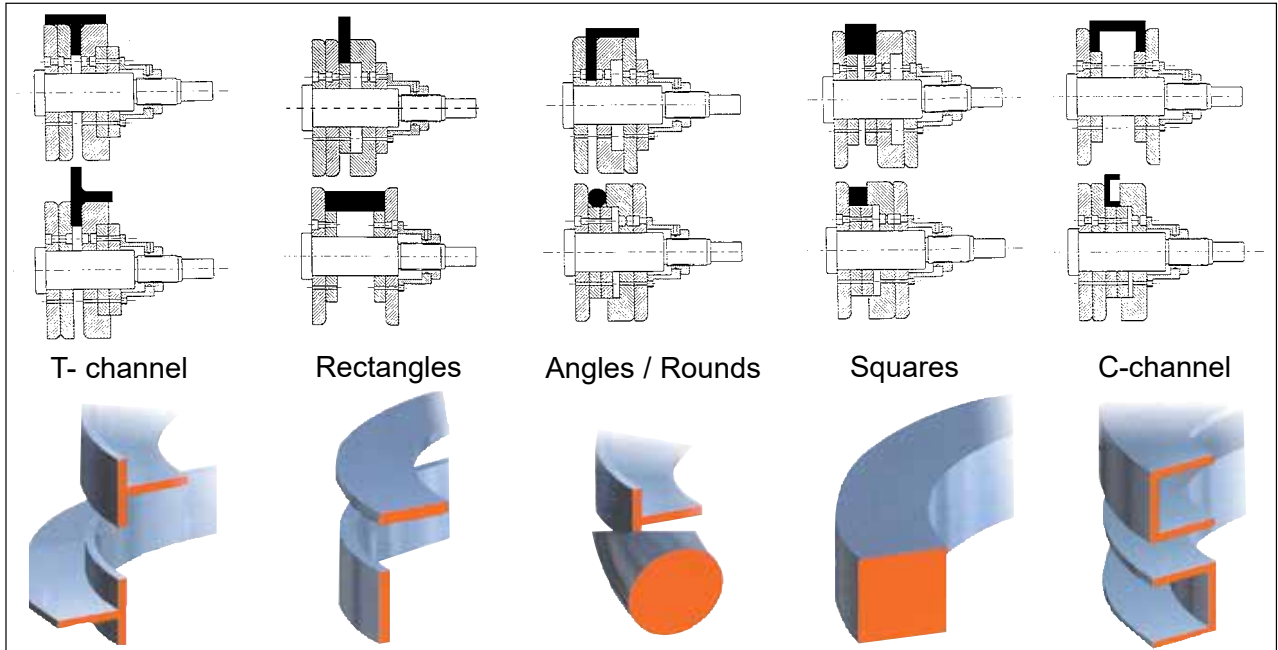

Part#	Description
C4ST	CE35 - CE40 – Universal tooling set
C5ST	CE50 - CE60 – Universal tooling set
C7ST	CE70 – Universal tooling set
C100ST	CE100 – Universal tooling set



Universal tooling set in Polymer available:  
CE35 - CE40 (C4STPOLY)  
and CE50 - CE60 (C5STPOLY)

# Modular Tooling Sets

Modular tooling sets support profiles, maintain smooth radius edges and reduce sharp knife-like edges.



Part#	Description
C4RC	CE35 - CE40 – 6 flanges and 6 spacers
C4RCPOLY	CE35 - CE40 – Poly modular tooling set
C5RC	CE50 - CE60 – 6 flanges and 9 spacers
C5RCPOLY	CE50 - CE60 – Poly modular tooling set
C70RC	CE70 – 6 flanges and 15 spacers
C100RC	CE100 – 6 flanges and 12 spacers

## Angle Roll-Section Bender Pipe Tooling Sets



Size	O.D.	CE35 - CE40	CE50 - CE60	CE70	CE100
1/4"	.540	C401P0250	C501P0250	NA	NA
3/8"	.675	C401P0375	C501P0375	*	*
1/2"	.840	C4SPD2**	C5SPD2**	*	*
3/4"	1.050	C4SPD1**	C5SPD1**	*	*
1"	1.315	C4SPD1**	C5SPD1**	C70P1000	C100P1000
1 1/4"	1.660	C4SPD2**	C5SPD2**	C70P1250	C100P1250
1 1/2"	1.900	C401P1500	C501P1500	C70P1500	C100P1500
2"	2.375	C401P2000 (CE40 only)	C501P2000	C70P2000	C100P2000
2 1/2"	2.875	NA	C501P2500	C70P2500	C100P2500
3"	3.500	NA	C501P3000†	C70P3000	C100P3000
4"	4.500	NA	NA	NA	C100P4000

\* Special order - consult factory for delivery      \*\* Combination Twin Tool Sets      † Only available for CE60 model

Consult factory for tooling sizes not shown.

## Angle Roll-Section Bender Tube Tooling Sets

Size	O.D.	CE35 - CE40	CE50 - CE60	CE70	CE100
1/4"	.250	C401T0250	C501T0250	NA	NA
3/8"	.375	C401T0375	C501T0375	NA	NA
1/2"	.500	C401T0500	C501T0500	NA	NA
5/8"	.625	C401T0625	C501T0625	NA	NA
3/4"	.750	C401T0750	C501T0750	NA	NA
7/8"	.875	C401T0875	C501T0875	NA	NA
1"	1.000	C401T1000	C501T1000	NS*	NS*
1 1/8"	1.125	C401T1125	C501T1125	NS*	NS*
1 1/4"	1.250	C401T1250	C501T1250	NS*	NS*
1 3/8"	1.375	C401T1375	C501T1375	NS*	NS*
1 1/2"	1.500	C401T1500	C501T1500	NS*	NS*
1 5/8"	1.625	C401T1625	C501T1625	NS*	NS*
1 3/4"	1.750	C401T1750	C501T1750	NS*	NS*
1 7/8"	1.875	C401T1875	C501T1875	NS*	NS*
2"	2.000	C401T2000	C501T2000	C70T2000	C100T2000
2 1/8"	2.125	C401T2125 (CE40 only)	C501T2125	NS*	NS*
2 1/4"	2.250	C401T2250 (CE40 only)	C501T2250	NS*	NS*
2 1/2"	2.500	C401T2500 (CE40 only)	C501T2500	C70T2500	C100T2500
2 3/4"	2.750	NA	C501T2750	NS*	NS*
3"	3.000	NA	C501T3000	C70T3000	C100T3000
4"	4.000	NA	NA	NA	C100T4000

\* Not stocked. Special order - consult factory for delivery.



# Polymer Roll Tooling Sets



Polymer tooling maintains material appearance reducing scratching and blemishes.

## Polymer Pipe Tooling

Size	O.D.	CE35 - CE40	CE50 - CE60
1"	1.315	C401NP1000	C501NP1000
1¼"	1.660	C401NP1250	C501NP1250
1½"	1.900	C401NP1500	C501NP1500
2"	2.375	C401NP2000 (CE40 only)	C501NP2000
2½"	2.875	NA	C501NP2500



## Polymer Tube Tooling

Size	O.D.	CE35 - CE40	CE50 - CE60
1"	1.000	C401NT1000	C501NT1000
1¼"	1.250	C401NT1250	C501NT1250
1½"	1.500	C401NT1500	C501NT1500
1¾"	1.750	C401NT1750	C501NT1750
2"	2.000	C401NT2000	C501NT2000
2½"	2.500	C401NT2500 (CE40 only)	C501NT2500

# Small Radius Tooling

## Small Radius Tooling

Adjustable tooling set for small radius bending applications.

Part# **C4RR** fits CE35 - CE40  
Part# **C5RR** fits CE50

### Tooling Material Capacities

Profile	Maximum
Square solids	5/8" x 5/8"
Rectangular solids	3/4" x 1/4"
Rounds	5/8"
T Stock	3/4" x 3/4"



# Cap Rail & Profile Tooling

Available by special order for angle roll machines. Consult CML USA with specific profile and dimensions.

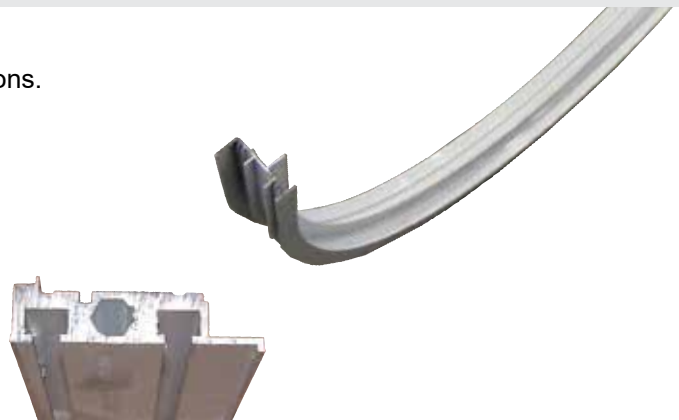
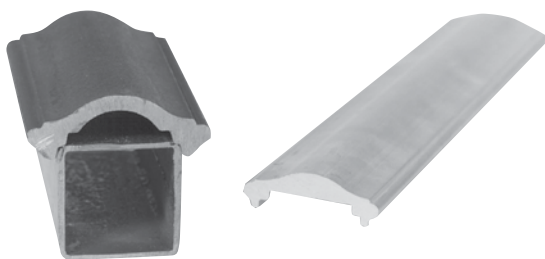

# Angle Roll-Section Bender Accessories

## Large Spiral Bending Accessory

Ideal for large pitch spiral bending applications. Material capacity 2" outside diameter.

Part# **CS5A11** fits CE40 - CE50 - CE60

Part# **CS7A11** fits CE70

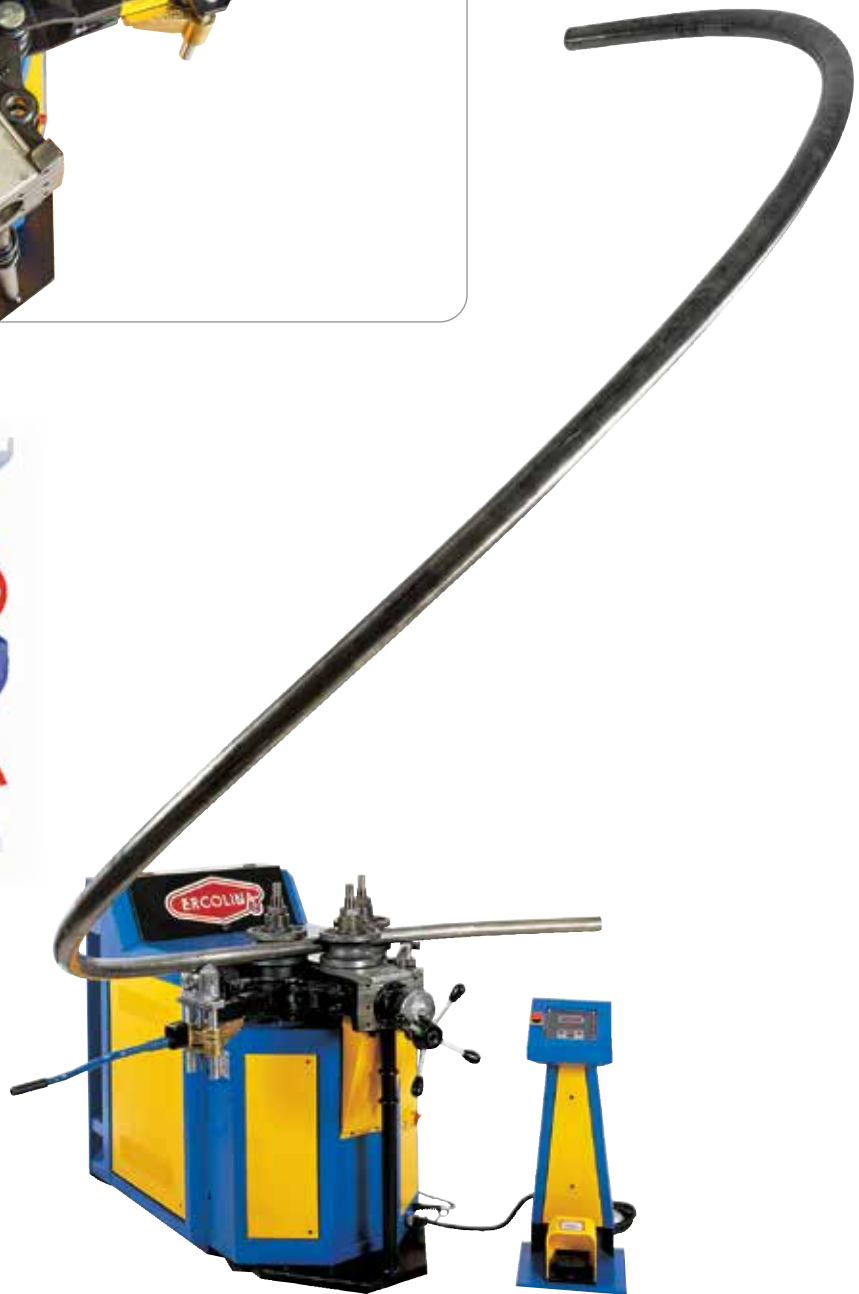
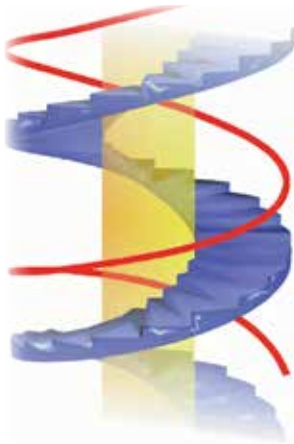
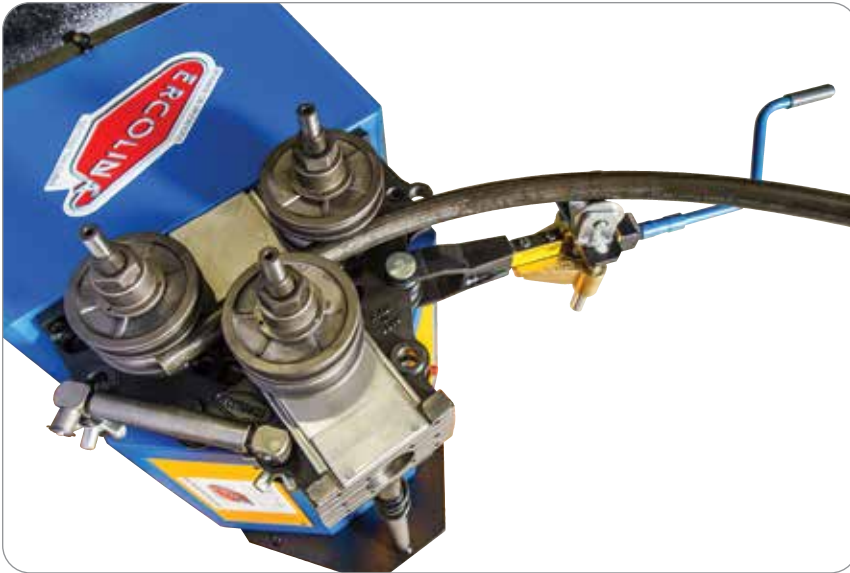



# Angle Roll-Section Bender Accessories



### Tie Bar Accessory

Recommended when bending large profiles or heavy wall material. Increases roll shaft rigidity and radii accuracy.  
 Part# **C5A2** fits CE40 and CE50  
 Part# **CE70A2** fits CE70  
 Part# **CE100A2** fits CE100



### Anti-Twist Device

Required for Angle iron "Leg In" applications.  
 Part# **CEA4-ECO40** fits CE35  
 Part# **C5A4** fits CE40 - CE50 - CE60

### Circular Segment

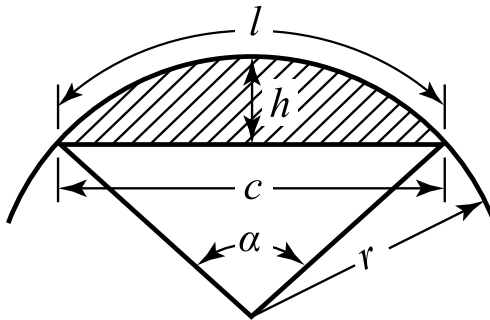

$$r = \frac{c^2 + 4h^2}{8h}$$

$l$  = length of arc;  $h$  = height at midpoint of chord;  $c$  = chord length;  
 $\alpha$  = angle, in degrees;  $r$  = radius.



### Fabricator's Measuring Set

Radius & Degree Measuring Kit - Part# **KARC**

Part#	Description of Kit Contents
ARC-160	Chord Gauge 160 mm
ARC-350	Chord Gauge 350 mm
FWOC-001	Digital Radius Gauge
FXC-025	Digital Angle Degree Protractor



## Bar Twisting Device

Part# CT4/2300 fits CE40

Part# CT5/2300 fits CE50



### Tooling included for Bar Twisting and Bending Small Spiral Tight Radius Rings and Hoops



- Quickly adapts to CE40 and CE50 angle rolls to create custom components for ornamental gates, railing and more
- Twists balusters up to 1" square
- Heavy duty construction with over (7') of workable table length
- Electromechanical interface provided to control rotation and repeatability
- Self aligning chuck and quick release tailstock system for easy material changeover







## Scroll Curling Device

Part# **CR4A8** fits CE40

Part# **CR5A8** fits CE50 and CE60



- Quickly adapts to CE40, CE50 and CE60 ring rolls to produce ornamental scrollwork
- Electromechanical interface provided to control exact rotation and repeatability
- Patented scroll pattern chain with removable links allows operator to select desired scroll pattern

Scroll Chain Radius Chart								
								
	Min	Max	Min	Max	Min	Max	L	Standard No. of Spirals
<b>SMALL</b> Chain Part # CERCP	3/8" x 3/16"	3/4" x 1/4"	3/16" x 3/16"	1/4" x 1/4"	3/16"	1/4"	4-3/8"	2
<b>MEDIUM</b> Chain Part # CERCM	3/8" x 5/16"	1-1/2" x 5/16"	5/16" x 5/16"	3/8" x 3/8"	5/16"	5/16"	4-3/8"	3
<b>LARGE</b> Chain Part # CERCG	3/8" x 1/4"	1-3/16" x 3/8"	1/4" x 1/4"	5/8" x 5/8"	1/4"	5/8"	9-7/8"	2

**Ships standard with Medium Scroll Chain**

# METALWORKING MACHINERY



METALWORKING MACHINERY



EN100

# Universal Pipe & Tube Notcher / Grinder

**✓ Fabricators Favorite**



Patented quick-change roller system

**3"**  
Notching Capacity

**1 Year**  
Limited WARRANTY

Part# EN100 machine only

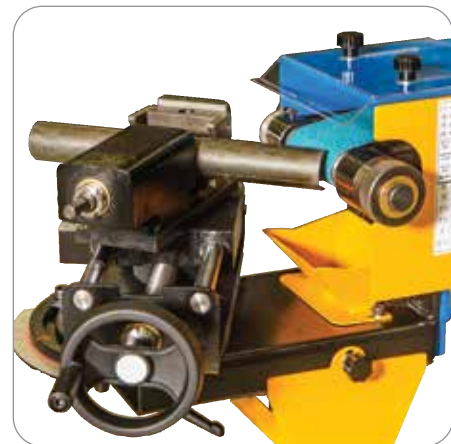

## Precision Notching

### FEATURES

- Quickly create perfect professional notches at any angle to 60°
- One handle moves pipe or tube in and across abrasive belt simultaneously - extending belt life and reducing heat (patented by Ercolina)
- Ideal for hand railing, chassis and roll cages, fences and gates, furniture frames, marine rails and arches, tubing and plumbing for restaurant and dairy
- Replaces outdated notching methods of using hole saws, end mills, grinding wheels and flame cutting
- Uses premium abrasive belts for a wide range of materials including; carbon steel, stainless steel, Inconel, chrome moly, aluminum and titanium
- Graduated vise 0-60° with vertical adjustment for offset angles
- Patented quick-change roller system
- Converts to abrasive belt grinder with optional accessory
- Top mounted deburring surface
- Over 25 notcher rollers available
- Tool free belt changeover

# EN100 Capacities & Specifications

Minimum Diameter	1"
Maximum Diameter	3" *
Angle Range	0-60° at 2 <sup>3</sup> / <sub>8</sub> " O.D.
Belt Size	4" x 76 <sup>3</sup> / <sub>4</sub> "
Belt Speed	100 FPS
Dust Extraction	Conventional
Voltage Requirement	220V or 480V 3ph
Motor	5½ hp 50-60Hz
Motor Speed	3650 RPM
Contact Wheel	NA
Length, Width, Height	52" x 22" x 43"
Shipping Weight	425 lbs.

\* (Consult factory for application information at maximum capacity.)

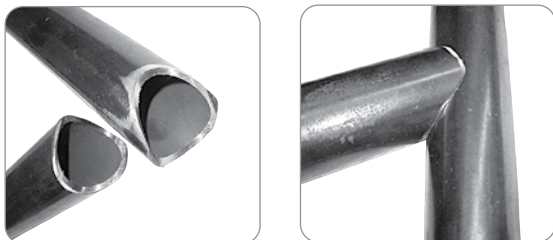

Notch angles to 60° in pipe or tube up to 3" in seconds, to a gap free fit ready for welding.

## EN100 Grinding Belts

Part#	Description
EN100BLT-76	40 grit – 4" x 76 <sup>3</sup> / <sub>4</sub> " Zirconia Alumina fits EN100
EN100BLTCR-76	36 grit – 4" x 76 <sup>3</sup> / <sub>4</sub> " Heavy-Duty Ceramic fits EN100
<b>For Serial No. 1006046 &amp; Older:</b>	
EN100BLT	40 grit – 4" x 79" Zirconia Alumina fits EN100
EN100BLTCR	36 grit – 4" x 79" Heavy-Duty Ceramic fits EN100

Belts also available in boxes of 10



Top Deburring Surface

## EN100 Notcher Rollers for Pipe

Pipe Size	Roller Part#
¾"	EN100RP0750
1"	EN100RP1000
1¼"	EN100RP1250
1½"	EN100RP1500
2"	EN100RP2000
2½"	EN100RP2500

## EN100 Notcher Rollers for Tube

Tube Size	Roller Part#
1"	EN100RT1000
1⅛"	EN100RT1125
1¼"	EN100RT1250
1⅜"	EN100RT1375
1½"	EN100RT1500
1⅝"	EN100RT1625
1¾"	EN100RT1750
2"	EN100RT2000
2¼"	EN100RT2250
2½"	EN100RT2500
3"	EN100RT3000

Product Demonstrations Available on Website

NEED ADDITIONAL HELP? CONTACT ERCOLINA:

**563.391.7700**

info@ercolina-usa.com



# Era Press

**EP25H2-V2**  
(25 tons of power)

## Horizontal Hydraulic Press

### STANDARD FEATURES

#### **Quick-change modular tooling**

Tooling available for tube flaring & flanging

Utilizes punch-style swage tooling

#### **Performs** metalworking press operations

Programmable touchpad control with back-lit LCD display  
(8 program storage)

**Accurate controls** of length of expansion or reduction or degree of fold with programmable cylinder stroke

**Expands and reduces** tube and pipe ends

**Heavy-duty** structure and rigid components

Adjustable working speed and hydraulic force

Remote pendant with low voltage controls

Hydraulic material clamping system



Part# EP25H2-V2  
machine only

**EP60**  
(50 tons of power)

### ADDITIONAL FEATURES ON EP60

Swage square and rectangular tube

Hand-held remote control certified class three safety

LCD touch screen control

**Unlimited** program storage with USB

Utilizes punch or finger-style swage tooling

**Energy saving** motor shuts off when not in use

Optional side shift feature reduces tooling changeover



Part# EP50H1  
machine only



EP60 Touch Screen Control Panel

## POWERFUL SWAGING AND METALWORKING PRESSES

## ERA PRESS INDUSTRIAL APPLICATIONS

### ERCOLINA HORIZONTAL HYDRAULIC PRESS

Ercolina's **EP25H2-V2** (25 ton hydraulic force) and **EP60** (60 ton hydraulic force) Era Press metalworking machines are programmable tube and pipe swaging machines and metalworking presses. Both models include standard tooling and offer optional tooling to form a wide variety of material.

Ercolina offers high quality equipment for a variety of industries around the globe.

Following is a partial list of industrial applications :

#### Swaging Tube & Pipe Reducing and Expanding

Furniture • Sports Equipment • Banner Displays • Ground-mounted Radio Towers

#### Flaring & Flanging Applications

Refrigeration • Air Conditioning • Hydraulic Hoses • Plumbing

#### Press Brake Applications

Bar Folding • Mounting Brackets • L-Brackets • Tabs

#### Custom Applications

Tube Beading



### Capacities & Specifications

	<b>EP25H2-V2</b>	<b>EP60</b>
Tube Diameter: Max. Expansion / Reduction	3½" x .120 (Tooling Dependent)	3½" - 4½" x .120
Square Tube	N/A	2½"
Folding Capacity - Steel Flat Bar	5" x ½"	7⅞" x ¾"
Working Speed	½" – 1" sec.	Variable programmable
Programming	Touchpad	LCD touch screen
Hydraulic Force	25 Tons	50 Tons
Horizontal Press	Yes	Yes
Maximum Stroke of Cylinder	6⅝"	11½"
Maximum Swage Depth	6" *	8" **
Voltage Requirement	220V/480V 3ph	480V 3ph
Motor	3½ hp 50-60Hz	8 hp 50-60Hz
Motor Speed	3650 RPM	3650 RPM
Length, Width, Height	41" x 29½" x 48"	48" x 26" x 44"
Shipping Weight	1,675 lbs.	2,300 lbs.

\* Swage depth greater than 4½" requires special tooling – must be specified at time of order.

\*\* Swage depth dependent on finger-style tools or standard reduction style – must be specified at time of order.

Contact CML USA for complete technical specifications. All capacities based on mild grade materials; heavy wall and high tensile materials reduce machine capacity.

# Era Press EP25H2-V2 Tooling

## Tooling Included With EP25H2-V2



FEP25-0006-00  
Expansion/Reduction  
Holder



FEP25T1  
Tube Expansion Tie Bar



FEP25-0007-00  
Prism Holder



FEP25-0005-00  
Straightening Supports

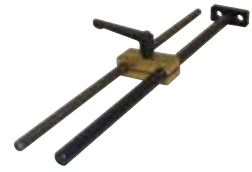

EPBM  
Adjustable Stop



# Era Press EP60 Tooling

## Tooling Included With EP60



FEP25-0006-00  
Expansion/Reduction  
Holder



FEP60T1  
Tube Expansion Tie Bar



FEP25-0007-00  
Prism Holder



FEP25-0005-00  
Straightening Supports

## Finger-style Reduction Tooling for Tube, Pipe & Square for EP60



A100SPF  
Reduction Cone Holder



Finger-Style Clamp  
(specify size  
when ordering)



Tapered Reduction Cone  
(specify size  
when ordering)

Diameter	Finger-Style Clamp for Tube & Pipe	Reduction Cone for Tube & Pipe
1"	HTR30-24	HTE20
1-1/4"	HTR32-26	HTE24
1-1/2"	HTR38-32	HTE32
1-3/4"	HTR46-40	HTE36
2"	HTR52-46	HTE42
2-1/4"	HTR58-52	HTE48
2-1/2"	HTR64-58	HTE54
2-3/4"	HTR70-64	HTE60
3"	HTR78-72	HTE68
3-1/2"	HTR88.9-82.6	HTE76.2
4"	HTR101.6-95.3	HTE95.3
4-1/2"	HTR114.3-108	HTE108

Diameter	Finger-Style Clamp for Square	Reduction Cone for Square
1"	*	*
1-1/4"	*	*
1-1/2"	*	*
2"	*	*

\* Available on request





### Bar Fold Tooling for EP25 and EP60



FEP2MS4V  
Folding Prism  
5/8" - 7/8" - 1 3/8"  
& 2" Openings  
Maximum Height 8"



FEP2MS85-80  
Folding Prism  
3 3/8" Opening  
Max Capacity:  
8" x 3/8" at 90°



FEP2SMS80-140  
Folding Prism  
5 1/2" Opening  
Max Capacity:  
8" x 1/2" at 90°



FEPL60R10  
Radius Folding Insert  
10MM Radius  
(Additional radii available)



FEP25-0008-00  
Flat Bar Folding Shaft  
with Radius Insert Holder

### Expansion / Reduction Tooling for EP25 and EP60



Expansion Punch  
(specify size when ordering)



Reduction Cup  
(specify size when ordering)



Clamp Jaw Set (set of 2)  
(specify size when ordering)

### Tube Sizes

Tube Size	Expansion Punch (EP25 & EP60)	Reduction Cup (EP25 & EP60)	Clamp Jaws (EP25)	Clamp Jaws (EP60)
1"	EP250E1T1000	EP250R1T1000	EP250G1T1000	EP60G1T1000
1-1/4"	EP250E1T1250	EP250R1T1250	EP250G1T1250	EP60G1T1250
1-1/2"	EP250E1T1500	EP250R1T1500	EP250G1T1500	EP60G1T1500
1-3/4"	EP250E1T1750	EP250R2T1750	EP250G1T1750	EP60G1T1750
2"	EP250E2T2000	EP250R2T2000	EP250G2T2000	EP60G2T2000
2-1/4"	EP250E2T2250	EP250R2T2250	EP250G2T2250	EP60G2T2250
2-1/2"	EP250E2T2500	EP250R2T2500	EP250G2T2500	EP60G2T2500
2-3/4"	EP250E2T2750	EP250R2T2750	EP250G2T2750	EP60G2T2750
3"	EP250E2T3000	EP250R2T3000	EP250G2T3000	EP60G2T3000
3-1/2"	EP250E2T3500	EP250R2T3500	EP250G2T3500	EP60G2T3500
<b>EP60 Only</b>				
4"	EP250E2T4000	EP250R2T4000	N/A	EP60G2T4000
4-1/2"	EP250E2T4500	EP250R2T4500	N/A	EP60G2T4500

### Pipe Sizes

Pipe Size	Expansion Punch (EP25 & EP60)	Reduction Cup (EP25 & EP60)	Clamp Jaws (EP25)	Clamp Jaws (EP60)
1"	EP250E1P1000	EP250R1P1000	EP250G1P1000	EP60G1P1000
1-1/4"	EP250E1P1250	EP250R1P1250	EP250G1P1250	EP60G1P1250
1-1/2"	EP250E1P1500	EP250R1P1500	EP250G1P1500	EP60G1P1500
2"	EP250E2P2000	EP250R2P2000	EP250G2P2000	EP60G2P2000
2-1/2"	EP250E2P2500	EP250R2P2500	EP250G2P2500	EP60G2P2500
3"	EP250E2P3000	EP250R2P3000	EP250G2P3000	EP60G2P3000
<b>EP60 Only</b>				
4"	N/A	EP250R2P4000	N/A	EP60G2P4000



# Erco Flange EFB220

## Flanging Machine



Part# EFB220 machine only

### TRADITIONAL FORMING SYSTEM MOST USED BY COMPETITORS

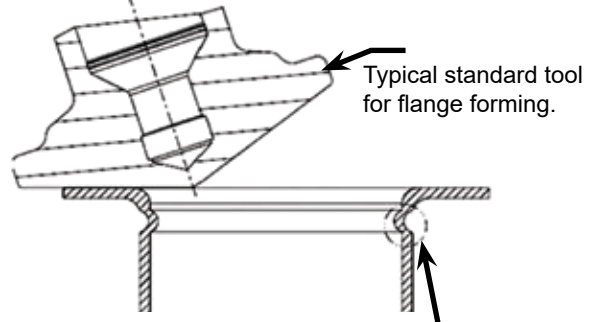

Main defect: collapsing of material around flange collar. Reduced tube diameter results in flow restriction.

### ERCOLINA INNOVATIVE FORMING SYSTEM

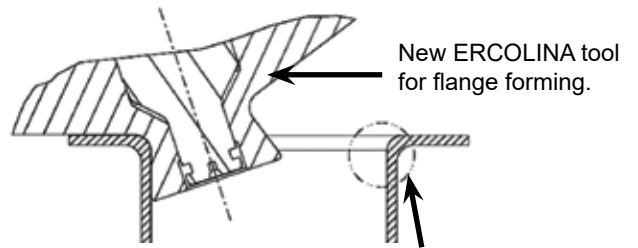

Thickness of material in area of flange radius may be increased. Gain in material at flange radius improves structural integrity.



## Innovative Design Solves Flange Issues

### FEATURES

- 37° and 90° flanges
- 8" gas max capacity
- PLC control, 5.7" touch screen
- Extremely easy setup
- Quick-change tooling
- Efficient: 30% cost reduction
- Heavy duty cast iron structure
- Double conical tools avoid swelling and deformation
- Consistent quality results



Ercolina's EFB uniformly cold forms a variety of materials including stainless, steel, copper and aluminum to 90° flanges in tubes with maximum wall thickness of .1875".

The innovative forming process uses a series of double conical tools to avoid swelling and deforming the flange.

Greater accuracy with minimum deformation results in less post-forming operations and higher productivity.

The EFB is equipped with a PLC control with 5.7" touch screen to easily control settings and machine operation.

Three types of tools for capacity from 3/4" to 8 5/8".

# Taking Care of Bending



Application Review



Demonstration / Training Facility

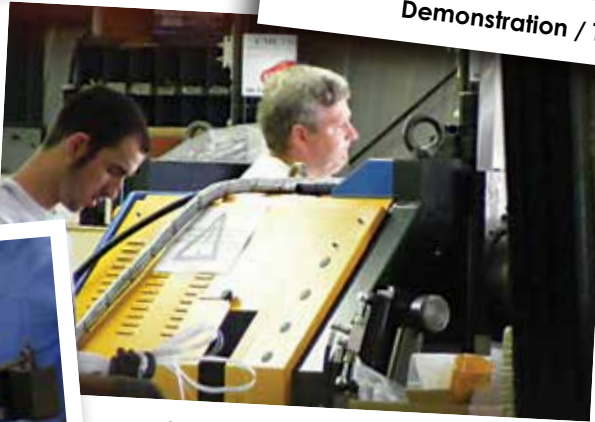

Service After the Sale



Hands-on Training



Quality Repeatable Bends with Ercolina®



## About This Catalog:

We have tried to make this catalog comprehensive and factual. CML USA, Inc. reserves the right to make changes at any time without notice to price, color, material, equipment, specifications, models, machine operation, tooling requirements and availability. Catalog may have been updated since the time of printing.

[ercolina-usa.com](http://ercolina-usa.com)



**Call TODAY for a quote!**  
Leasing Options Available



**CML USA Inc. Ercolina®**

**"Excellence in Quality, Support and Service"**

3100 Research Parkway • Davenport, IA 52806

Ph. 563-391-7700 • [info@ercolina-usa.com](mailto:info@ercolina-usa.com)

**[ercolina-usa.com](http://ercolina-usa.com)**